

# High-Precision End Mill Holders

Extend tool life with our H5 End Mill holders.



## Features

- *Balanced to 15,000 RPM at G6.3*
- *DualDRIVE balanced to 25,000 RPM at G2.5*
- *Taper ground to AT3 specification*

## Coolant Options

CoolBLAST coolant ports blast coolant on tool path. CoolFLEX holders feature coolant-thru tool or DIN B coolant.

CoolBLAST ports



## Manufactured to an H5 Bore Tolerance

All Techniks end mill holder bores are manufactured to meet or exceed the H5 specification. H5 is an extremely accurate bore I.D. and provides improved T.I.R. for extended cutting tool life. (see how T.I.R. affects tool life below)

Brand X = .0008"

Techniks = .0002"

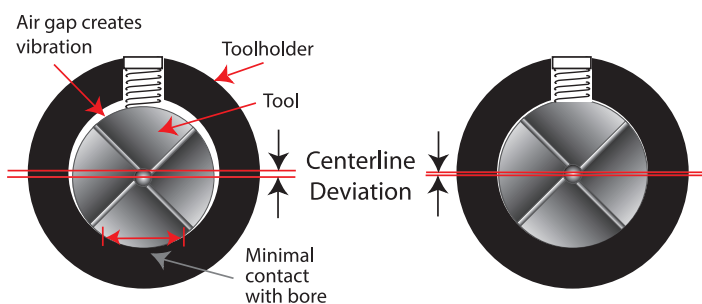

<http://ow.ly/rIk7B>  
View the video.

You lose 10% of tool life for every .0001" of T.I.R.  
Techniks H5 bore tolerance to extends cutting tool life.

Built for Speed.



All Techniks products are backed by our 100% satisfaction guarantee!



We stand behind all our products with our 100% Satisfaction Guarantee • [www.techniksusa.com](http://www.techniksusa.com)

# CAT40 Precision End Mill Holders

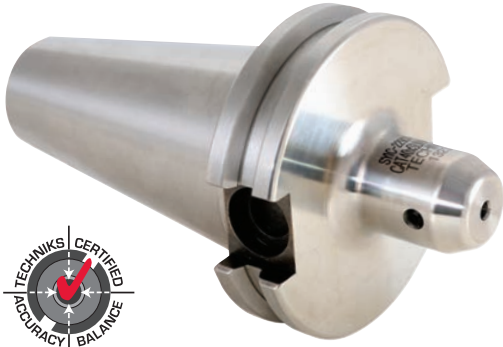

Techniks Certified for bore and taper tolerances

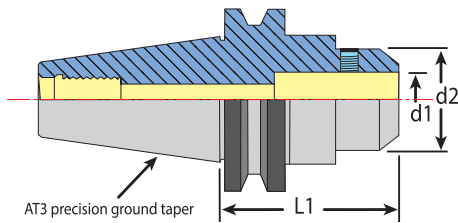

## Features

- High precision bore (H5) is best in industry
- Balanced to 15,000 RPM at G6.3
- Taper ground to AT3 for maximum spindle contact

## CAT40 End Mill Holders Inch Size

Part No.	Description	d1	L1	d2
22907	CAT40 x 1/8" I.D. - 2.37"	1/8"	2.37"	.69"
22909	CAT40 x 3/16" I.D. - 2.5"	3/16"	2.5"	.69"
22911	CAT40 x 1/4" I.D. - 3"	1/4"	3"	.78"
22911-2.5	CAT40 x 1/4" I.D. - 2.5"	1/4"	2.5"	.78"
22913	CAT40 x 5/16" I.D. - 3"	5/16"	3"	.88"
22913-2.5	CAT40 x 5/16" I.D. - 2.5"	5/16"	2.5"	.88"
22915	CAT40 x 3/8" I.D. - 3"	3/8"	3"	1.0"
22915-2.5	CAT40 x 3/8" I.D. - 2.5"	3/8"	2.5"	1.0"
22916-2.5	CAT40 x 7/16" I.D. - 2.5"	7/16"	2.5"	1.13"
22917	CAT40 x 1/2" I.D. - 3"	1/2"	3"	1.25"
22917-2.5	CAT40 x 1/2" I.D. - 2.5"	1/2"	2.5"	1.25"
22917-2.63	CAT40 x 1/2" I.D. - 2.63"	1/2"	2.63"	1.25"
22919	CAT40 x 5/8" I.D. - 3"	5/8"	3"	1.5"
22920	CAT40 x 5/8" I.D. - 3.75"	5/8"	3.75"	1.5"
22921	CAT40 x 3/4" I.D. - 3.5"	3/4"	3.5"	1.75"
22921-3	CAT40 x 3/4" I.D. - 3"	3/4"	3"	1.75"
22923	CAT40 x 7/8" I.D. - 3.5"	7/8"	3.5"	1.88"
22925-3	CAT40 x 1.0" I.D. - 3"	1.0"	3"	2"
22925	CAT40 x 1.0" I.D. - 4"	1.0"	4"	2"
22927	CAT40 x 1.25" I.D. - 4.6"	1.25"	4.6"	2.5"
22927-4	CAT40 x 1.25" I.D. - 4"	1.25"	4"	2.5"
22929	CAT40 x 1.5" I.D. - 4.5"	1.5"	4.5"	2.5"

## CAT40 End Mill Holders Metric Size

Part No.	Description	d1	L1	d2
22963	CAT40 x 6mm I.D. - 2.5"	6mm	2.5"	25mm
22965	CAT40 x 8mm I.D. - 2.5"	8mm	2.5"	28mm
22967	CAT40 x 10mm I.D. - 2.5"	10mm	2.5"	35mm
22969	CAT40 x 12mm I.D. - 2.5"	12mm	2.5"	42mm
22971	CAT40 x 16mm I.D. - 2.5"	16mm	2.5"	48mm
22973	CAT40 x 20mm I.D. - 3"	20mm	3"	52mm
22975	CAT40 x 25mm I.D. - 4"	25mm	4"	65mm
22977	CAT40 x 32mm I.D. - 4"	32mm	4"	72mm

## CAT40 Stubby Length End Mill Holders



Stubby

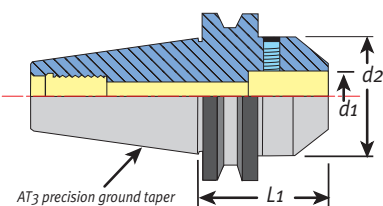

Part No.	Description	d1	L1	d2
22907-1.75	CAT40 x 1/8" I.D. - 1.75"	1/8"	1.75"	.75"
22909-1.75	CAT40 x 3/16" I.D. - 1.75"	3/16"	1.75"	.79"
22911-1.75	CAT40 x 1/4" I.D. - 1.75"	1/4"	1.75"	.79"
22913-1.75	CAT40 x 5/16" I.D. - 1.75"	5/16"	1.75"	.88"
22915-1.75	CAT40 x 3/8" I.D. - 1.75"	3/8"	1.75"	.88"
22916-1.75	CAT40 x 7/16" I.D. - 1.75"	7/16"	1.75"	1.12"
22917-1.75	CAT40 x 1/2" I.D. - 1.75"	1/2"	1.75"	1.50"
22919-1.75	CAT40 x 5/8" I.D. - 1.75"	5/8"	1.75"	1.50"
22921-1.75	CAT40 x 3/4" I.D. - 1.75"	3/4"	1.75"	1.75"
22925A-1.75	CAT40 x 1.0" I.D. - 1.75"	1.0"	1.75"	2"
22927A-2	CAT40 x 1-1/4" I.D. - 2"	1-1/4"	2"	2.5"

# CAT40 Precision End Mill Holders

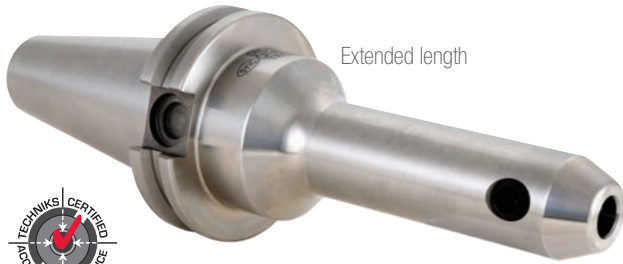

Techniks Certified for bore and taper tolerances

## Features

- High precision bore (H5) is best in industry
- Balanced to 15,000 RPM at G6.3
- Taper ground to AT3 for maximum spindle contact

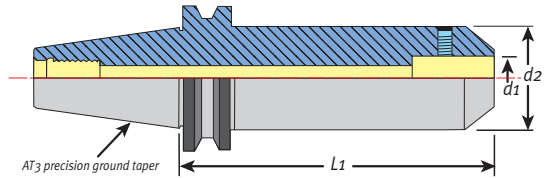

## CAT40 Extended Length End Mill Holders

Part No.	Description	d1	L1	d2
22907-6	CAT40 x 1/8" I.D. - 6"	1/8"	6"	.69"
22909-6	CAT40 x 3/16" I.D. - 6"	3/16"	6"	.69"
22911-6	CAT40 x 1/4" I.D. - 6"	1/4"	6"	.78"
22915-5	CAT40 x 3/8" I.D. - 5"	3/8"	5"	1.0"
<b>NEW</b> 22915-6	CAT40 x 3/8" I.D. - 6"	3/8"	6"	1.0"
22917-4.63	CAT40 x 1/2" I.D. - 4.63"	1/2"	4.63"	1.25"
<b>NEW</b> 22917-6	CAT40 x 1/2" I.D. - 6"	1/2"	6"	1.25"
22920-5.75	CAT40 x 5/8" I.D. - 5.75"	5/8"	5.75"	1.5"
22921-5	CAT40 x 3/4" I.D. - 5"	3/4"	5"	1.75"
<b>NEW</b> 22921-6.5	CAT40 x 3/4" I.D. - 6.5"	3/4"	6.5"	1.75"
22925-6	CAT40 x 1.0" I.D. - 6"	1.0"	6"	2"
22927-6	CAT40 x 1 -1/4" I.D. - 6"	1 -1/4"	6"	2.5"



Techniks Certified for bore and taper tolerances

Our Rigid Reach End Mill holders are great for machining in tight areas at extended length where tolerance is important. The tapered design improves rigidity and overall cutting performance.

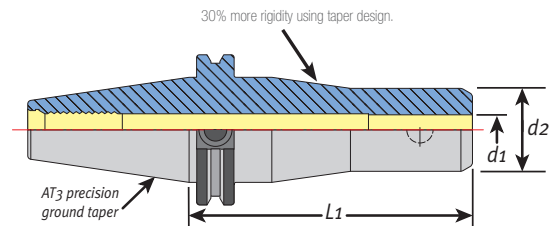

## CAT40 Rigid Reach End Mill Holders

Part No.	Description	d1	L1	d2
22907-5.00-RR	CAT40 x 1/8" I.D. - 5"	1/8"	5"	.78"
22909-4.72-RR	CAT40 x 3/16" I.D. - 4.72"	3/16"	4.72"	.78"
22911-4.72-RR	CAT40 x 1/4" I.D. - 4.72"	1/4"	4.72"	.78"
22913-4.72-RR	CAT40 x 5/16" I.D. - 4.72"	5/16"	4.72"	.86"
22915-4.72-RR	CAT40 x 3/8" I.D. - 4.72"	3/8"	4.72"	1.0"
22917-4.72-RR	CAT40 x 1/2" I.D. - 4.72"	1/2"	4.72"	1.38"



We stand behind all our products with our 100% Satisfaction Guarantee • [www.techniksusa.com](http://www.techniksusa.com)

# CAT40 Precision CoolBLAST End Mill Holders



## Features

- High precision bore (H5) is best in industry
- Balanced to 15,000 RPM at G6.3
- Taper ground to AT3 specification



Techniks Certified for bore and taper tolerances



Retention  
Knobs  
pg. 228



Lock  
Screws  
pg. 91



Wrenches  
pg. 232



Tightening  
Stands  
pg. 234



CoolBLAST ports



CoolBLAST in-the-bore coolant ports blast coolant on the tool path, even at high RPMs.

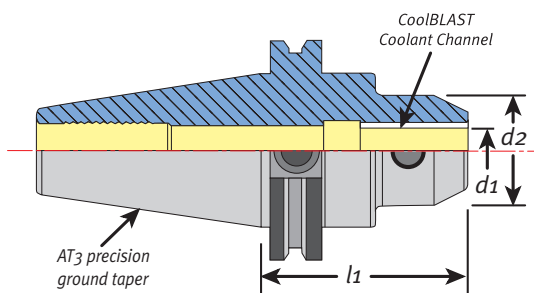

## CAT40 CoolBLAST End Mill Holders

Part No.	Description	d1	l1	d2
22909-6B	CAT40 x 3/16" I.D. - 6"	3/16"	6"	.69"
22911-2.5B	CAT40 x 1/4" I.D. - 2.5"	1/4"	2.5"	.78"
22911-6B	CAT40 x 1/4" I.D. - 6"	1/4"	6"	.78"
22915-2.5B	CAT40 x 3/8" I.D. - 2.5"	3/8"	2.5"	1.0"
22915-4B	CAT40 x 3/8" I.D. - 4"	3/8"	4"	1.0"
22917-2.5B	CAT40 x 1/2" I.D. - 2.5"	1/2"	2.5"	1.25"
22917B	CAT40 x 1/2" I.D. - 3"	1/2"	3"	1.25"
22917-4B	CAT40 x 1/2" I.D. - 4"	1/2"	4"	1.25"
22919B	CAT40 x 5/8" I.D. - 3"	5/8"	3"	1.5"
22919-4B	CAT40 x 5/8" I.D. - 4"	5/8"	4"	1.5"
22921-1.75B	CAT40 x 3/4" I.D. - 1.75"	3/4"	1.75"	1.75"
22921-3B	CAT40 x 3/4" I.D. - 3"	3/4"	3"	1.75"
22921-4B	CAT40 x 3/4" I.D. - 4"	3/4"	4"	1.75"
22925B	CAT40 x 1.0" I.D. - 4"	1.0"	4"	2"

Blue indicates coolant.

# CAT40 Precision CoolBLAST/CoolFLEX End Mill Holders



Techniks Certified for bore and taper tolerances

## Features

- High precision bore (H5) is best in industry
- Balanced to 15,000 RPM at G6.3
- Taper ground to AT3 specification

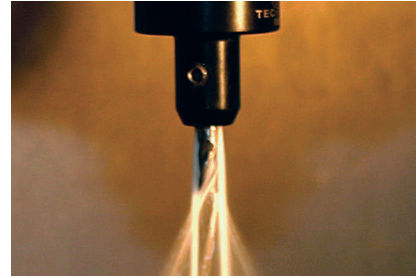

CoolBLAST in-the-bore coolant ports blast coolant on the tool path, even at high RPMs.

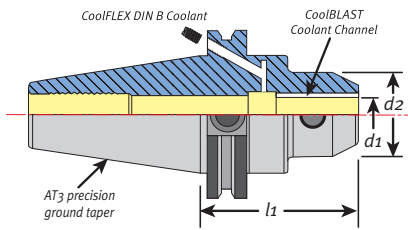

## CoolFLEX Feature

CoolFLEX holders are factory set for coolant-thru spindle. Simply remove 2 stop screws for DIN B coolant-thru flange.

### Part No. Description

HSA-4-6	40 taper DIN B screw
---------	----------------------

thru flange      thru spindle

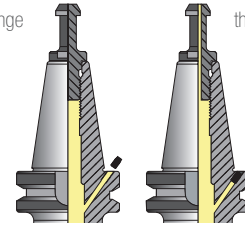

Coolant Set Screws page 47.

## CAT40 CoolBLAST Holders with CoolFLEX

Part No.	Description	d1	l1	d2
22909-6FB	CAT40 x 3/16" I.D. - 6"	3/16"	6"	.69"
22911-2.5FB	CAT40 x 1/4" I.D. - 2.5"	1/4"	2.5"	.78"
22911-4FB	CAT40 x 1/4" I.D. - 4"	1/4"	4"	.78"
22911-6FB	CAT40 x 1/4" I.D. - 6"	1/4"	6"	.78"
22913-6FB	CAT40 x 5/16" I.D. - 6"	5/16"	6"	.88"
22915-2.5FB	CAT40 x 3/8" I.D. - 2.5"	3/8"	2.5"	1.0"
22915-5FB	CAT40 x 3/8" I.D. - 5"	3/8"	5"	1.0"
22917-2.5FB	CAT40 x 1/2" I.D. - 2.5"	1/2"	2.5"	1.25"
22917-4FB	CAT40 x 1/2" I.D. - 4"	1/2"	4"	1.25"
22919-1.75FB	CAT40 x 5/8" I.D. - 1.75"	5/8"	1.75"	1.5"
22920-6FB	CAT40 x 5/8" I.D. - 6"	5/8"	6"	1.5"
22921-3FB	CAT40 x 3/4" I.D. - 3"	3/4"	3"	1.75"
22925FB	CAT40 x 1.0" I.D. - 4"	1.0"	4"	2"

Blue indicates coolant.



# CAT40 Precision CoolFLEX End Mill Holders



Techniks Certified for bore and taper tolerances

## Features

- High precision bore (H5) is best in industry
- Balanced to 15,000 RPM at G6.3
- Taper ground to AT3 specification

## CoolFLEX Feature

CoolFLEX holders are factory set for coolant-thru spindle. Simply remove two stop screws for DIN B coolant-thru flange.

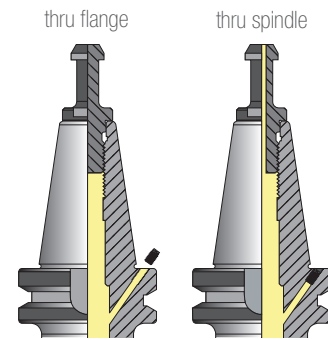

## Replacement CoolFLEX Screws

Part No.	Description
HSA-4-6	40 taper DIN B screw

Coolant Set Screws page 47.

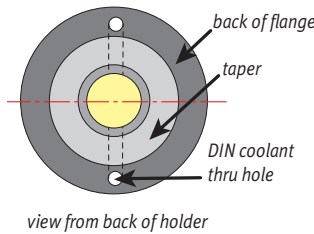
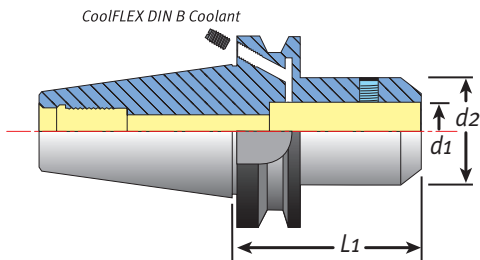

## CAT40 CoolFLEX End Mill Holders

Part No.	Description	d1	l1	d2
22911F	CAT40 x 1/4" I.D. - 3"	1/4"	3"	.78"
22911-2.5F	CAT40 x 1/4" I.D. - 2.5"	1/4"	2.5"	.78"
22913-2.5F	CAT40 x 5/16" I.D. - 2.5"	5/16"	2.5"	.88"
22913F	CAT40 x 5/16" I.D. - 3"	5/16"	3"	.88"
22915-2.5F	CAT40 x 3/8" I.D. - 2.5"	3/8"	2.5"	1.0"
22915F	CAT40 x 3/8" I.D. - 3"	3/8"	3"	1.0"
22915-5F	CAT40 x 3/8" I.D. - 5"	3/8"	5"	1.0"
22916-2.5F	CAT40 x 7/16" I.D. - 2.5"	7/16"	2.5"	1.13"
22917F	CAT40 x 1/2" I.D. - 3"	1/2"	3"	1.25"
22919-1.75F	CAT40 x 5/8" I.D. - 1.75"	5/8"	1.75"	1.5"
22919F	CAT40 x 5/8" I.D. - 3"	5/8"	3"	1.5"
22921-1.75F	CAT40 x 3/4" I.D. - 1.75"	3/4"	1.75"	1.75"
22921-3F	CAT40 x 3/4" I.D. - 3"	3/4"	3"	1.75"
22921-5F	CAT40 x 3/4" I.D. - 5"	3/4"	5"	1.75"
22925-1.75F	CAT40 x 1.0" I.D. - 1.75"	1.0"	1.75"	2"
22925F	CAT40 x 1.0" I.D. - 4"	1.0"	4"	2"
22927F	CAT40 x 1-1/4" I.D. - 4.6"	1-1/4"	4.6"	2.5"
22929F	CAT40 x 1-1/2" I.D. - 4.5"	1-1/2"	4.5"	2.5"

Blue indicates coolant.

# CAT40 DualDRIVE for Dual-Contact Spindles



Techniks Certified for bore and taper tolerances



Retention  
Knobs  
pg. 228



Lock  
Screws  
pg. 91



Wrenches  
pg. 232



Tightening  
Stands  
pg. 234

## Features

- High precision bore (H5) is best in industry
- Balanced to 25,000 RPM at G2.5
- Taper ground to AT3 specification

## DualDRIVE for Dual Contact spindles

- Techniks Certified for Dual Contact
- Also for use in standard spindles

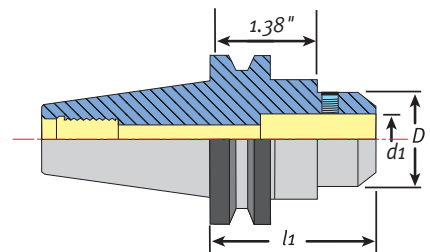

## CAT40 DualDRIVE End Mill Holders

Part No.	Description d1 – l1	l1	d1	D
43.653.56.300	CAT40 x SLN 3/8" - 3" DualDRIVE toolholder	3"	3/8"	1"
43.653.56.500	CAT40 x SLN 3/8" - 5" DualDRIVE toolholder	5"	3/8"	1"
43.653.58.300	CAT40 x SLN 1/2" - 3" DualDRIVE toolholder	3"	1/2"	1.25"
43.653.58.463	CAT40 x SLN 1/2" - 4.63" DualDRIVE toolholder	4.63"	1/2"	1.25"
43.653.61.300	CAT40 x SLN 5/8" - 3" DualDRIVE toolholder	3"	5/8"	1.5"
43.653.61.375	CAT40 x SLN 5/8" - 3.75" DualDRIVE toolholder	3.75"	5/8"	1.5"
43.653.61.575	CAT40 x SLN 5/8" - 5.75" DualDRIVE toolholder	5.75"	5/8"	1.5"
43.653.64.350	CAT40 x SLN 3/4" - 3.5" DualDRIVE toolholder	3.5"	3/4"	1.75"
43.653.64.500	CAT40 x SLN 3/4" - 5" DualDRIVE toolholder	5"	3/4"	1.75"
43.653.68.400	CAT40 x SLN 1.0" - 4" DualDRIVE toolholder	4"	1.0"	2"
43.653.68.600	CAT40 x SLN 1.0" - 6" DualDRIVE toolholder	6"	1.0"	2"
43.653.72.460	CAT40 x SLN 1-1/4" - 4.6" DualDRIVE toolholder	4.6"	1-1/4"	2.5"
43.653.72.400	CAT40 x SLN 1-1/4" - 4" DualDRIVE toolholder	4"	1-1/4"	2.5"
43.653.72.600	CAT40 x SLN 1-1/4" - 6" DualDRIVE toolholder	6"	1-1/4"	2.5"
43.653.77.450	CAT40 x SLN 1-1/2" - 4 1/2" DualDRIVE toolholder	4.5"	1-1/2"	2.5"

### Dual-Contact Spindles

Use Techniks DualDRIVE holders if your machine has a dual-contact spindle. Dual-Contact is a spindle option offered by some machine tool builders.

Dual-contact means both the toolholder taper and the flange make contact with the spindle. Dual-contact increases rigidity and accuracy during machining.

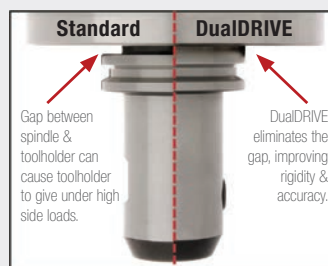

See our demonstration video of DualDRIVE at:  
<http://ow.ly/sUOqL>



# CAT50 Precision End Mill Holders



Techniks Certified for bore and taper tolerances



Retention Knobs  
pg. 228



Lock Screws  
pg. 91



Wrenches  
pg. 232



Tightening Stands  
pg. 234

## CAT50 End Mill Holders Metric Size

Part No.	Description	d1	L1	d2
22981	CAT50 x 6mm I.D. - 4"	6mm	4"	25mm
22983	CAT50 x 8mm I.D. - 4"	8mm	4"	28mm
22985	CAT50 x 10mm I.D. - 4"	10mm	4"	35mm
22987	CAT50 x 12mm I.D. - 4"	12mm	4"	42mm
22989	CAT50 x 16mm I.D. - 4"	16mm	4"	48mm
22990	CAT50 x 20mm I.D. - 3"	20mm	3"	52mm
22993	CAT50 x 25mm I.D. - 4"	25mm	4"	65mm
22996	CAT50 x 32mm I.D. - 4.6"	32mm	4.6"	72mm

## Features

- High precision bore (H5) is best in industry
- Balanced to 15,000 RPM at G6.3
- Taper ground to AT3 for maximum spindle contact

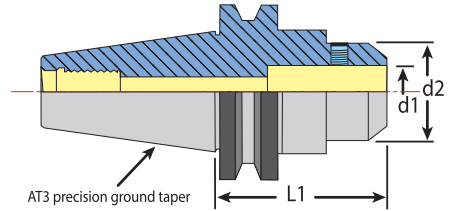

## CAT50 End Mill Holders Inch Size

Part No.	Description	d1	L1	d2
22931	CAT50 x 1/4" I.D. - 4"	1/4"	4"	.78"
22933	CAT50 x 5/16" I.D. - 4"	5/16"	4"	.88"
22935	CAT50 x 3/8" I.D. - 4"	3/8"	4"	1.0"
22937	CAT50 x 1/2" I.D. - 4"	1/2"	4"	1.25"
22939-3	CAT50 x 5/8" I.D. - 3"	5/8"	3"	1.5"
22939	CAT50 x 5/8" I.D. - 4"	5/8"	4"	1.5"
22941-3	CAT50 x 3/4" I.D. - 3"	3/4"	3"	1.75"
22941	CAT50 x 3/4" I.D. - 4"	3/4"	4"	1.75"
22943	CAT50 x 7/8" I.D. - 4"	7/8"	4"	1.88"
22945	CAT50 x 1.0" I.D. - 4"	1.0"	4"	2"
22947	CAT50 x 1-1/4" I.D. - 4.6"	1-1/4"	4.6"	2.5"
22949	CAT50 x 1-1/2" I.D. - 4.6"	1-1/2"	4.6"	2.5"



Stubby

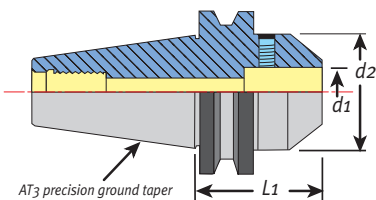

## CAT50 Stubby Length End Mill Holders

Part No.	Description	d1	L1	d2
22931-2 1/2	CAT50 x 1/4" I.D. - 2.5"	1/4"	2.5"	.78"
22935-2 1/2	CAT50 x 3/8" I.D. - 2.5"	3/8"	2.5"	1.0"
22937-2 5/8	CAT50 x 1/2" I.D. - 2.67"	1/2"	2.67"	1.5"
22939-9/16-1.44	CAT50 x 9/16" I.D. - 1.44"	9/16"	1.44"	1.5"
22939-9/16-3	CAT50 x 9/16" I.D. - 3"	9/16"	3"	1.5"
22939-1.44	CAT50 x 5/8" I.D. - 1.44"	5/8"	1.44"	1.5"
22941-1.44	CAT50 x 3/4" I.D. - 1.44"	3/4"	1.44"	1.75"
22945-2.62	CAT50 x 1.0" I.D. - 2.62"	1"	2.62"	2"
22947-2.62	CAT50 x 1-1/4" I.D. - 2.62"	1-1/4"	2.62"	2.5"
22949-2	CAT50 x 1-1/2" I.D. - 2"	1-1/2"	2"	2.75"



# CAT50 Precision End Mill Holders



Extended length

Techniks H5 Bore Tolerance Extends Tool Life 60%

## Features

- High precision bore (H5) is best in industry
- Balanced to 15,000 RPM at G6.3
- Taper ground to AT3 for maximum spindle contact

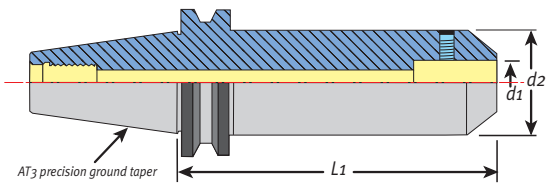

Rigid Reach

30% more rigidity using taper design.

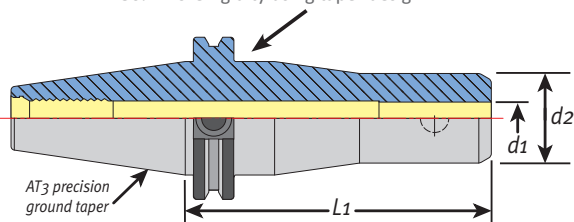

Our Rigid Reach End Mill holders are great for machining in tight areas at extended length where tolerance is important. The tapered design improves rigidity and overall cutting performance.

## CAT50 Extended Length End Mill Holders

Part No.	Description	d1	L1	d2	
22931-8	CAT50 x 1/4" I.D. - 8"	1/4"	8"	.78"	<b>NEW</b>
22935-6	CAT50 x 3/8" I.D. - 6"	3/8"	6"	1.0"	
22935-8	CAT50 x 3/8" I.D. - 8"	3/8"	8"	1.0"	
22937-6	CAT50 x 1/2" I.D. - 6"	1/2"	6"	1.25"	
22937-8	CAT50 x 1/2" I.D. - 8"	1/2"	8"	1.25"	
22939-6	CAT50 x 5/8" I.D. - 6"	5/8"	6"	1.5"	
22939-8	CAT50 x 5/8" I.D. - 8"	5/8"	8"	1.5"	
22941-5.75	CAT50 x 3/4" I.D. - 5.75"	3/4"	5.75"	1.75"	
22941-6	CAT50 x 3/4" I.D. - 6"	3/4"	6"	1.75"	
22941-8	CAT50 x 3/4" I.D. - 8"	3/4"	8"	1.75"	
22943-6	CAT50 x 7/8" I.D. - 6"	7/8"	6"	1.88"	
22943-8	CAT50 x 7/8" I.D. - 8"	7/8"	8"	1.88"	
22945-6	CAT50 x 1.0" I.D. - 6"	1.0"	6"	2"	
22946-8	CAT50 x 1.0" I.D. - 8"	1.0"	8"	2"	
22947-6	CAT50 x 1-1/4" I.D. - 6"	1-1/4"	6"	2.5"	
22947-8	CAT50 x 1-1/4" I.D. - 8"	1-1/4"	8"	2.5"	
22951	CAT50 x 2" I.D. - 6"	2"	6"	3.75"	

## CAT50 Rigid Reach End Mill Holders

Part No.	Description	d1	L1	d2	
22931-6.5T	CAT50 x 1/4" I.D. - 6.5"	1/4"	6.5"	.78"	
22931-10T	CAT50 x 1/4" I.D. - 10"	1/4"	10"	.78"	<b>NEW</b>
22935-6.5T	CAT50 x 3/8" I.D. - 6.5"	3/8"	6.5"	1.0"	
22935-10T	CAT50 x 3/8" I.D. - 10"	3/8"	10"	1.0"	<b>NEW</b>
22937-6.5T	CAT50 x 1/2" I.D. - 6.5"	1/2"	6.5"	1.38"	
22937-10T	CAT50 x 1/2" I.D. - 10"	1/2"	10"	1.25"	<b>NEW</b>
22939-7.25T	CAT50 x 5/8" I.D. - 7.25"	5/8"	7.25"	1.5"	
22939-10T	CAT50 x 5/8" I.D. - 10"	5/8"	10"	1.5"	<b>NEW</b>
22941-7.25T	CAT50 x 3/4" I.D. - 7.25"	3/4"	7.25"	1.75"	
22941-10T	CAT50 x 3/4" I.D. - 10"	3/4"	10"	1.75"	<b>NEW</b>
22945-8T	CAT50 x 1.0" I.D. - 8"	1.0"	8"	2"	
22945-10T	CAT50 x 1.0" I.D. - 10"	1.0"	10"	2"	<b>NEW</b>
22947-10T	CAT50 x 1-1/4" I.D. - 10"	1-1/4"	10"	2.5"	<b>NEW</b>

# CAT50 Precision CoolBLAST End Mill Holders



Techniks Certified for bore and taper tolerances

## CoolBLAST Features

- Blast coolant directly on tool path
- No need for expensive coolant-thru tools
- High precision bore (H5) is best in industry



Retention Knobs  
pg. 228



Lock Screws  
pg. 91



Wrenches  
pg. 232



Tightening Stands  
pg. 234

CoolBLAST ports

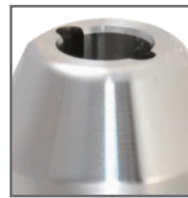

CoolBLAST in-the-bore coolant ports blast coolant on the tool path, even at high RPMs.

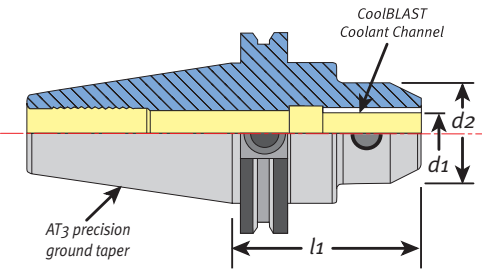

## CAT50 CoolBLAST End Mill Holders

Part No.	Description	d1	l1	d2
22931-2.5B	CAT50 x 1/4" I.D. - 2.5"	1/4"	2.5"	.78"
22931B	CAT50 x 1/4" I.D. - 4"	1/4"	4"	.78"
22931-6B	CAT50 x 1/4" I.D. - 6"	1/4"	6"	.78"
<b>NEW</b> 22931-8B	CAT50 x 1/4" I.D. - 8"	1/4"	8"	.78"
<b>NEW</b> 22931-10BT	CAT50 x 1/4" I.D. - 10"	1/4"	10"	.78"
22935-2.5B	CAT50 x 3/8" I.D. - 2.5"	3/8"	2.5"	1.0"
22935B	CAT50 x 3/8" I.D. - 4"	3/8"	4"	1.0"
22935-6B	CAT50 x 3/8" I.D. - 6"	3/8"	6"	1.0"
22935-8B	CAT50 x 3/8" I.D. - 8"	3/8"	8"	1.0"
<b>NEW</b> 22935-10BT	CAT50 x 3/8" I.D. - 10"	3/8"	10"	1.0"
22937-2.625B	CAT50 x 1/2" I.D. - 2-5/8"	1/2"	2-5/8"	1.25"
22937B	CAT50 x 1/2" I.D. - 4"	1/2"	4"	1.25"
22937-6B	CAT50 x 1/2" I.D. - 6"	1/2"	6"	1.25"
22937-8B	CAT50 x 1/2" I.D. - 8"	1/2"	8"	1.25"
<b>NEW</b> 22937-10BT	CAT50 x 1/2" I.D. - 10"	1/2"	10"	1.25"
22939-3B	CAT50 x 5/8" I.D. - 3"	5/8"	3"	1.5"
22939B	CAT50 x 5/8" I.D. - 4"	5/8"	4"	1.5"
22939-6B	CAT50 x 5/8" I.D. - 6"	5/8"	6"	1.5"
<b>NEW</b> 22939-10BT	CAT50 x 5/8" I.D. - 10"	5/8"	10"	1.5"

Part No.	Description	d1	l1	d2
22941-1.44B	CAT50 x 3/4" I.D. - 1.44"	3/4"	1.44"	1.75"
22941-3B	CAT50 x 3/4" I.D. - 3"	3/4"	3"	1.75"
22941B	CAT50 x 3/4" I.D. - 4"	3/4"	4"	1.75"
22941-6B	CAT50 x 3/4" I.D. - 6"	3/4"	6"	1.75"
22941-8B	CAT50 x 3/4" I.D. - 8"	3/4"	8"	1.75"
22941-10BT	CAT50 x 3/4" I.D. - 10"	3/4"	10"	1.75"
22943-6B	CAT50 x 7/8" I.D. - 6"	7/8"	6"	1.88"
22943-8B	CAT50 x 7/8" I.D. - 8"	7/8"	8"	2"
22945B	CAT50 x 1.0" I.D. - 4"	1.0"	4"	2"
22945-6B	CAT50 x 1.0" I.D. - 6"	1.0"	6"	2"
22946-8B	CAT50 x 1.0" I.D. - 8"	1.0"	8"	2"
22945-10BT	CAT50 x 1.0" I.D. - 10"	1.0"	10"	2"
22947-2.62B	CAT50 x 1-1/4" I.D. - 2.62"	1-1/4"	2.62"	2.5"
22947B	CAT50 x 1-1/4" I.D. - 4.6"	1-1/4"	4.6"	2.5"
22947-6B	CAT50 x 1-1/4" I.D. - 6"	1-1/4"	6"	2.5"
22947-8B	CAT50 x 1-1/4" I.D. - 8"	1-1/4"	8"	2.5"
22947-10BT	CAT50 x 1-1/4" I.D. - 10"	1-1/4"	10"	2.5"
22949B	CAT50 x 1-1/2" I.D. - 4.6"	1-1/2"	4.6"	2.5"
22951B	CAT50 x 2" I.D. - 6"	2"	6"	3.75"

Note: Part numbers with "BT" = Tapered design

# CAT50 Precision CoolFLEX End Mill Holders



Techniks Certified for bore and taper tolerances

## CoolFLEX Features

- Coolant-thru spindle or thru flange (DIN B)
- High precision bore (H5) is best in industry
- Balanced to 15,000 RPM at G6.3

Techniks H5 Bore Tolerance Extends Tool Life 60%  
You lose 10% of cutting tool life  
for every .0001" of T.I.R.

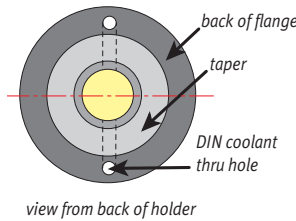
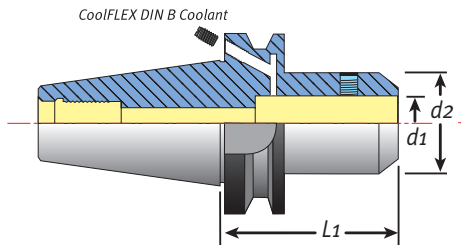
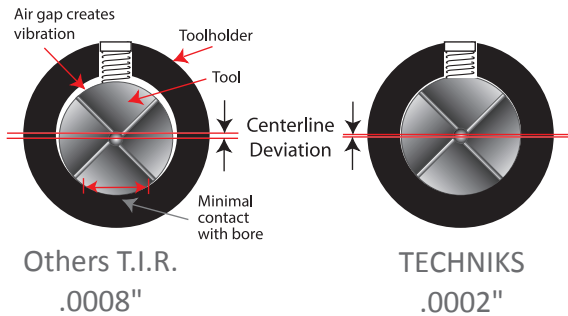

## CoolFLEX Feature

CoolFLEX holders are factory set for coolant-thru spindle. Simply remove two stop screws for DIN B coolant-thru flange.

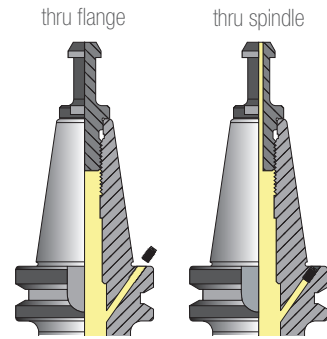

## Replacement CoolFLEX Screws

Part No.	Description
HSA-6-6	50 taper DIN B screw

Coolant Set Screws page 47.

## CAT50 CoolFLEX End Mill Holders

Part No.	Description	d1	l1	d2
22931F	CAT50 x 1/4" I.D. - 4"	1/4"	4"	.78"
22935F	CAT50 x 3/8" I.D. - 4"	1/4"	4"	1.00"
22937F	CAT50 x 1/2" I.D. - 4"	1/2"	4"	1.25"
22937-6F	CAT50 x 1/2" I.D. - 6"	1/2"	6"	1.25"
22937-8F	CAT50 x 1/2" I.D. - 8"	1/2"	8"	1.25"
22939F	CAT50 x 5/8" I.D. - 4"	5/8"	4"	1.5"
22941-3F	CAT50 x 3/4" I.D. - 3"	3/4"	3"	1.75"
22941F	CAT50 x 3/4" I.D. - 4"	3/4"	4"	1.75"
22945-2.62F	CAT50 x 1" I.D. - 2.62"	1.0"	2.62"	2"
22945F	CAT50 x 1.0" I.D. - 4"	1.0"	4"	2"
22947F	CAT50 x 1-1/4" I.D. - 4.6"	1-1/4"	4.6"	2.5"
22949F	CAT50 x 1-1/2" I.D. - 4.6"	1-1/2"	4.6"	2.5"

Blue indicates coolant.



We stand behind all our products with our 100% Satisfaction Guarantee • [www.techniksusa.com](http://www.techniksusa.com)

# CAT50 DualDRIVE for Dual-Contact Spindles



Techniks Certified for bore and taper tolerances



Retention Knobs  
pg. 228



Lock Screws  
pg. 91



Wrenches  
pg. 232



Tightening Stands  
pg. 234

## Features

- Techniks Certified for dual-contact spindles
- High precision bore (H5) is best in industry
- Balanced to 25,000 RPM at G2.5

## Benefits

- Better rigidity and reduced vibration (chatter)
- Improved performance at high metal removal rates and when machining at extended lengths

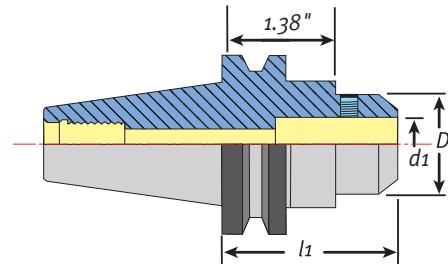

## CAT50 DualDRIVE End Mill Holders

Part No.	Description d1 – L1	l1	d1	D
44.653.58.400	CAT50 x SLN 1/2" - 4" DualDRIVE	4"	1/2"	1.25"
44.653.58.600	CAT50 x SLN 1/2" - 6" DualDRIVE	6"	1/2"	1.25"
44.653.61.400	CAT50 x SLN 5/8" - 4" DualDRIVE	4"	5/8"	1.5"
44.653.61.600	CAT50 x SLN 5/8" - 6" DualDRIVE	6"	5/8"	1.5"
44.653.64.144	CAT50 x SLN 3/4" - 1.44" DualDRIVE	1.44"	3/4"	1.75"
44.653.64.300	CAT50 x SLN 3/4" - 3" DualDRIVE	3"	3/4"	1.75"
44.653.64.400	CAT50 x SLN 3/4" - 4" DualDRIVE	4"	3/4"	1.75"
44.653.64.600	CAT50 x SLN 3/4" - 6" DualDRIVE	6"	3/4"	1.75"
44.653.68.400	CAT50 x SLN 1.0" - 4" DualDRIVE	4"	1.0"	2"
44.653.68.262	CAT50 x SLN 1.0" - 2.62" DualDRIVE	2.62"	1.0"	2.484"
44.653.68.600	CAT50 x SLN 1.0" - 6" DualDRIVE	6"	1.0"	2.484"
44.653.72.262	CAT50 x SLN 1-1/4" - 2.62" DualDRIVE	2.62"	1-1/4"	2.75"
44.653.72.460	CAT50 x SLN 1-1/4" - 4.6" DualDRIVE	4.6"	1-1/4"	2.5"
44.653.72.600	CAT50 x SLN 1-1/4" - 6" DualDRIVE	6"	1-1/4"	2.75"
44.653.72.800	CAT50 x SLN 1-1/4" - 8" DualDRIVE	8"	1-1/4"	2.5"
44.653.77.460	CAT50 x SLN 1-1/2" - 4.6" DualDRIVE	4.6"	1-1/2"	2.5"
44.653.77.800	CAT50 x SLN 1-1/2" - 8" DualDRIVE	8"	1-1/2"	2.5"

### Dual-Contact Spindles

Use Techniks DualDRIVE holders if your machine has a dual-contact spindle. Dual-Contact is a spindle option offered by some machine tool builders.

Dual-contact means both the toolholder taper and the flange make contact with the spindle. Dual-contact increases rigidity and accuracy during machining.

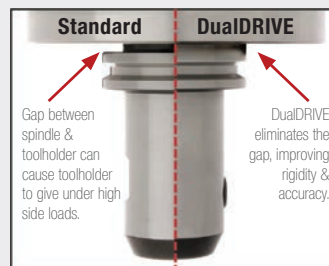

See our demonstration video of DualDRIVE at:  
<http://ow.ly/sUOqL>

# BT30 and BT30 DualDRIVE for Dual-Contact Spindles



Techniks Certified for bore and taper tolerances

## Features

- High precision bore (H5) is best in industry
- Balanced to 15,000 RPM at G6.3
- Taper ground to AT3 for maximum spindle contact

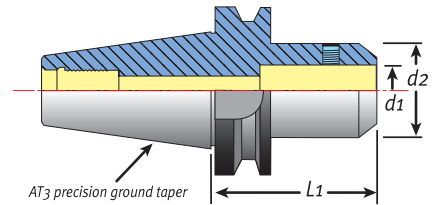

## BT30 End Mill Holders

Part No.	Description	d1	L1	d2
17130-1/8	BT30 x 1/8" I.D. - 2.36" End Mill holder	1/8"	2.36"	.68"
17130-3/16	BT30 x 3/16" I.D. - 2.36" End Mill holder	3/16"	2.36"	.68"
17130-1/4	BT30 x 1/4" I.D. - 2.36" End Mill holder	1/4"	2.36"	.78"
17130-5/16	BT30 x 5/16" I.D. - 2.36" End Mill holder	5/16"	2.36"	.88"
17130-3/8	BT30 x 3/8" I.D. - 2.36" End Mill holder	3/8"	2.36"	1.0"
17130-7/16	BT30 x 7/16" I.D. - 2.36" End Mill holder	7/16"	2.36"	1.12"
17130-1/2	BT30 x 1/2" I.D. - 2.36" End Mill holder	1/2"	2.36"	1.25"
17130-5/8	BT30 x 5/8" I.D. - 2.36" End Mill holder	5/8"	2.36"	1.5"
17130-3/4	BT30 x 3/4" I.D. - 2.36" End Mill holder	3/4"	2.36"	1.75"



Techniks Certified for bore and taper tolerances

## Features

- New one-piece design for dual-contact spindles
- High precision bore (H5) is best in industry
- Balanced to 25,000 RPM at G2.5

## Benefits

- Better rigidity and reduced vibration
- Improved performance at high metal removal rates or extended lengths

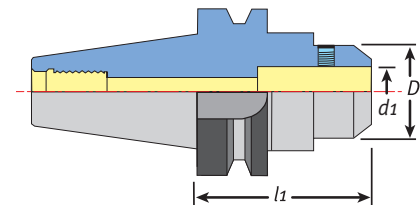

## BT30 DualDRIVE End Mill Holders

Part No.	Description d1 – l1	l1	d1	D
25.653.52.250	BT30 x SLN 1/8" - 2.5" DualDRIVE	2.5"	1/8"	.68"
25.653.53.250	BT30 x SLN 3/16" - 2.5" DualDRIVE	2.5"	3/16"	.68"
25.653.54.250	BT30 x SLN 1/4" - 2.5" DualDRIVE	2.5"	1/4"	.78"
25.653.56.250	BT30 x SLN 3/8" - 2.5" DualDRIVE	2.5"	3/8"	1.0"
25.653.58.250	BT30 x SLN 1/2" - 2.5" DualDRIVE	2.5"	1/2"	1.25"
25.653.61.250	BT30 x SLN 5/8" - 2.5" DualDRIVE	2.5"	5/8"	1.5"
25.653.64.300	BT30 x SLN 3/4" - 3" DualDRIVE	3"	3/4"	1.75"



# BT40 Precision End Mill Holders



Techniks Certified for bore and taper tolerances

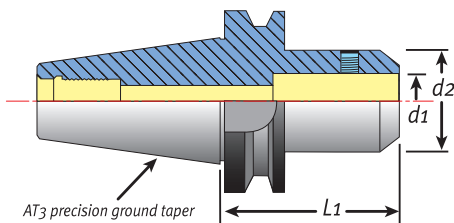

## Features

- High precision bore (H5) is best in industry
- Balanced to 15,000 RPM at G6.3
- Taper ground to AT3 for maximum spindle contact

Techniks H5 Bore Tolerance Extends Tool Life 60%  
You lose 10% of cutting tool life  
for every .0001" of T.I.R.

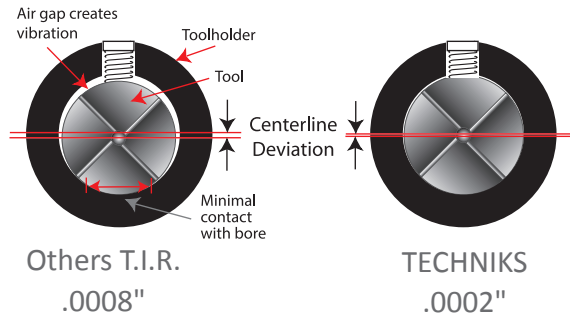

## BT40 End Mill Holders Inch Size

Part No.	Description	d1	L1	d2
17140-1/8	BT40 x 1/8" I.D. - 2.5"	1/8"	2.5"	.68"
17140-3/16	BT40 x 3/16" I.D. - 2.5"	3/16"	2.5"	.68"
17140-1/4	BT40 x 1/4" I.D. - 2.5"	1/4"	2.5"	.78"
17140-5/16	BT40 x 5/16" I.D. - 2.5"	5/16"	2.5"	.88"
17140-3/8	BT40 x 3/8" I.D. - 2.5"	3/8"	2.5"	1.0"
17140-7/16	BT40 x 7/16" I.D. - 2.5"	7/16"	2.5"	1.10"
17140-1/2	BT40 x 1/2" I.D. - 2.5"	1/2"	2.5"	1.25"
17140-5/8	BT40 x 5/8" I.D. - 2.5"	5/8"	2.5"	1.50"
17140-3/4	BT40 x 3/4" I.D. - 2.5"	3/4"	2.5"	1.75"
17140-1	BT40 x 1.0" I.D. - 3.56"	1.0"	3.56"	2"
17140-1-1/4	BT40 x 1-1/4" I.D. - 3.56"	1-1/4"	3.56"	2.5"
17140-1-1/2	BT40 x 1-1/2" I.D. - 3.56"	1-1/2"	3.56"	2.5"

## BT40 End Mill Holders Metric Size

Part No.	Description	d1	L1	d2
17131	BT40 x 6mm I.D. - 50mm	6mm	50mm	25mm
17132	BT40 x 8mm I.D. - 50mm	8mm	50mm	28mm
17133	BT40 x 10mm I.D. - 63mm	10mm	63mm	35mm
17134	BT40 x 12mm I.D. - 63mm	12mm	63mm	42mm
17135	BT40 x 16mm I.D. - 63mm	16mm	63mm	48mm
17135-18	BT40 x 18mm I.D. - 63mm	18mm	63mm	50mm
17136	BT40 x 20mm I.D. - 63mm	20mm	63mm	52mm
17137	BT40 x 25mm I.D. - 100mm	25mm	100mm	65mm
17138	BT40 x 32mm I.D. - 100mm	32mm	100mm	72mm

# BT40 Precision End Mill Holders



Techniks Certified for bore and taper tolerances

## Techniks Certified Tooling Features

- High precision bore (H5) is best in industry
- Balanced to 15,000 RPM at G6.3
- Taper ground to AT3 for maximum spindle contact

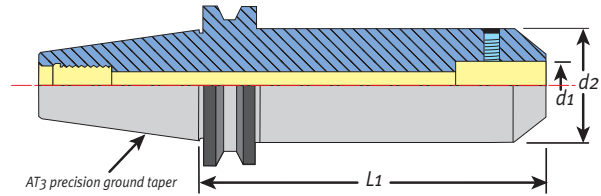

## BT40 Extended Length End Mill Holders

Part No.	Description	d1	L1	d2
17140-1/8-4	BT40 x 1/8" I.D. - 4"	1/8"	4"	.68"
17140-3/16-4	BT40 x 3/16" I.D. - 4"	3/16"	4"	.68"
17140-1/4-4	BT40 x 1/4" I.D. - 4"	1/4"	4"	.78"
17140-3/8-4	BT40 x 3/8" I.D. - 4"	3/8"	4"	1.0"
17140-1/2-4	BT40 x 1/2" I.D. - 4"	1/2"	4"	1.25"
17140-5/8-4	BT40 x 5/8" I.D. - 4"	5/8"	4"	1.5"
17140-3/4-4	BT40 x 3/4" I.D. - 4"	3/4"	4"	1.75"
17140-7/8-5	BT40 x 7/8" I.D. - 5"	7/8"	5"	1.75"
17140-1-5	BT40 x 1.0" I.D. - 5"	1.0"	5"	2"



Techniks Certified for bore and taper tolerances

Our Rigid Reach End Mill holders are great for machining in tight areas at extended length where tolerance is important. The tapered design improves rigidity and overall cutting performance.

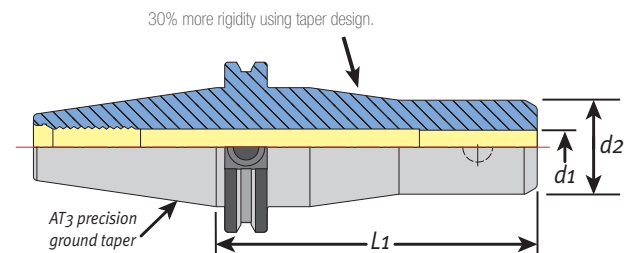

## BT40 Rigid Reach End Mill Holders

Part No.	Description	d1	L1	d2
17140-1/8-5.0-RR	BT40 x 1/8" I.D. - 5"	1/8"	5"	.78"
17140-3/16-4.72-RR	BT40 x 3/16" I.D. - 4.72"	3/16"	4.72"	.78"
17140-1/4-4.72-RR	BT40 x 1/4" I.D. - 4.72"	1/4"	4.72"	.78"
17140-3/8-4.72-RR	BT40 x 3/8" I.D. - 4.72"	3/8"	4.72"	1.0"
17140-1/2-4.72-RR	BT40 x 1/2" I.D. - 4.72"	1/2"	4.72"	1.38"
17140-3/4-6-RR	BT40 x 3/4" I.D. - 6"	3/4"	6"	1.38"



We stand behind all our products with our 100% Satisfaction Guarantee • [www.techniksusa.com](http://www.techniksusa.com)

# BT40 Precision CoolFLEX End Mill Holders



Techniks Certified for bore and taper tolerances

## Features

- High precision bore (H5) is best in industry
- Balanced to 15,000 RPM at G6.3
- Taper ground to AT3 specification



Retention Knobs  
pg. 228



Lock Screws  
pg. 91



Wrenches  
pg. 232



Tightening Stands  
pg. 234

Techniks H5 Bore Tolerance Extends Tool Life 60%  
You lose 10% of cutting tool life for every .0001" of T.I.R.

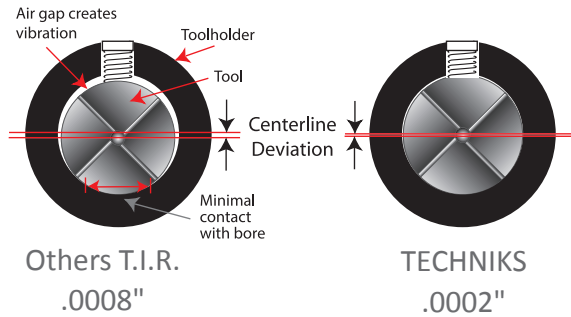

## CoolFLEX Feature

CoolFLEX holders are factory set for coolant-thru spindle. Simply remove two stop screws for DIN B coolant-thru flange.

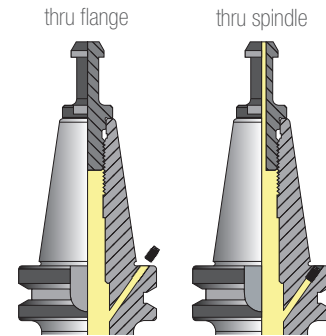

## Replacement CoolFLEX Screws

Part No.	Description
HSA-4-6	40 taper DIN B screw

Coolant Set Screws page 47.

CoolFLEX DIN B Coolant

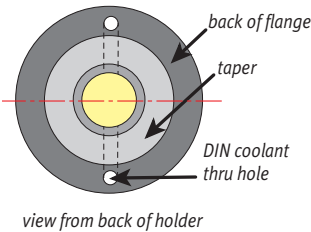
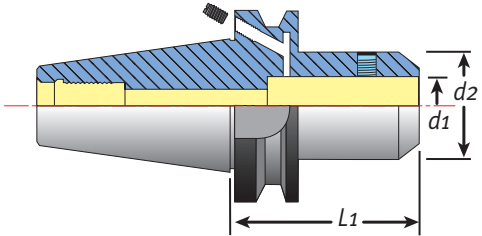

## BT40 CoolFLEX End Mill Holders

Part No.	Description	d1	L1	d2
17140-1/4F	BT40 x 1/4" I.D. - 2.5"	1/4"	2.5"	.78"
17140-3/8F	BT40 x 3/8" I.D. - 2.5"	3/8"	2.5"	1.0"
17140-1/2F	BT40 x 1/2" I.D. - 2.5"	1/2"	2.5"	1.25"
17140-5/8F	BT40 x 5/8" I.D. - 2.5"	5/8"	2.5"	1.50"
17140-3/4F	BT40 x 3/4" I.D. - 2.5"	3/4"	2.5"	1.75"
17140-1F	BT40 x 1.0" I.D. - 3.56"	1.0"	3.56"	2"
17140-1-1/4F	BT40 x 1-1/4" I.D. - 3.56"	1-1/4"	3.56"	2.5"

Blue indicates coolant.



# BT50 Precision End Mill Holders – End Mill Lock Screws



Techniks Certified for bore and taper tolerances

## Features

- High precision bore (H5) is best in industry
- Balanced to 15,000 RPM at G6.3
- Taper ground to AT3 for maximum spindle contact

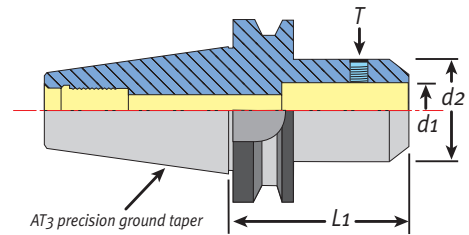

## BT50 End Mill Holders

Part No.	Description	d1	l1	d2
17150-1/4	BT50 x 1/4" I.D. - 3"	1/4"	3"	.78"
17150-3/8	BT50 x 3/8" I.D. - 2.75"	3/8"	2.75"	1.0"
17150-1/2	BT50 x 1/2" I.D. - 3"	1/2"	3"	1.25"
17150-5/8	BT50 x 5/8" I.D. - 3"	5/8"	3"	1.5"
17150-3/4	BT50 x 3/4" I.D. - 3"	3/4"	3"	1.75"
17150-1-4.5	BT50 x 1.0" I.D. - 4.5"	1.0"	4.5"	2"
17150-1-6	BT50 x 1.0" I.D. - 6"	1.0"	6"	2"
17150-1-1/4-4.5	BT50 x 1.25" I.D. - 4.5"	1.25"	4.5"	2.5"
18593	BT50 x 1.5" I.D. - 4.13"	1.5"	4.13"	-



## Replacement Lock Screws

Please specify your bore I.D. (shank size) when ordering replacement lock screws to ensure correct replacement. (Inch: below / Metric: right)

Part No.	Metric	Thread
HSA-18-20	18mm	M18 x 2.0P
HSA-20-20	20mm	M20 x 2.0P

Part No.	Fits EMH I.D.	Length	Torque	Stubby Body	Thread
22954-5/16	1/8"	5/16" (.3125)	10 ft/lbs	-	6-32
22955-1/4	3/16"	1/4" (.25)	3 ft/lbs	-	8-32
22956-5/16	1/4"	5/16" (.3125)	5 ft/lbs	-	1/4-28
22957-1/4	3/8"	1/4" (.25)	15 ft/lbs	22915-1.75	5/16-24
22957-5/16	5/16"	5/16" (.3125)	14 ft/lbs	-	5/16-24
22958-5/16	3/8"	5/16" (.3125)	15 ft/lbs	-	3/8-24
22959-5/16	7/16"	5/16" (.3125)	16 ft/lbs	-	7/16-20
22959-3/8	1/2"	3/8" (.375)	20 ft/lbs	-	7/16-20
22959-7/16	5/8"	7/16" (.4375)	40 ft/lbs	-	1/2-20
22961-9/32	1-1/4"	9/32" (.2813)	110 ft/lbs	22927A-2	5/8-18
22961-7/16	1"	7/16" (.4375)	110 ft/lbs	22925-1.75(F) , 22923 , 22925-3	5/8-18
22961-1/2	3/4"	1/2" (.5)	70 ft/lbs	-	5/8-18
22961-1/2	7/8"	1/2" (.5)	70 ft/lbs	-	5/8-18
22962-1/2	1.0"	1/2" (.5)	110 ft/lbs	-	3/4-16
22961-5/8	1-1/4"	5/8" (.625)	110 ft/lbs	22947-2.62	5/8-18



# HSK63A, 63F, 100A Precision End Mill Holders



HSK63A

## Features

- I.D. bore tolerance is H5
- Balanced to 15,000 RPM at G6.3
- Taper ground to AT3 tolerance



Techniks Certified for bore and taper tolerances

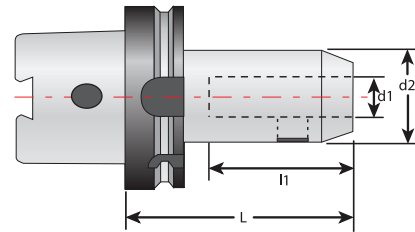

## HSK63A End Mill Holders

	Part No.	Description - I.D.	d1	d2	L	l1
<b>NEW</b>	32946	HSK63A x End Mill holder 1/8"	1/8"	.68"	3"	.79"
<b>NEW</b>	32946-5	HSK63A x End Mill holder 1/8"	1/8"	.68"	5"	.79"
<b>NEW</b>	32947	HSK63A x End Mill holder 3/16"	3/16"	.68"	3"	1.0"
<b>NEW</b>	32947-5	HSK63A x End Mill holder 3/16"	3/16"	.68"	5"	1.0"
<b>NEW</b>	32948	HSK63A x End Mill holder 1/4"	1/4"	.78"	3"	1.38"
<b>NEW</b>	32948-5	HSK63A x End Mill holder 1/4"	1/4"	.78"	5"	1.38"
<b>NEW</b>	32952	HSK63A x End Mill holder 3/8"	3/8"	1.0"	3"	1.54"
<b>NEW</b>	32952-5	HSK63A x End Mill holder 3/8"	3/8"	1.0"	5"	1.54"
	32954	HSK63A x End Mill holder 1/2"	1/2"	1.38"	3"	1.97"
<b>NEW</b>	32954-5	HSK63A x End Mill holder 1/2"	1/2"	1.38"	5"	1.97"
	32956	HSK63A x End Mill holder 5/8"	5/8"	1.63"	3.75"	2.09"
<b>NEW</b>	32956-5	HSK63A x End Mill holder 5/8"	5/8"	1.63"	5"	2.09"
	32958	HSK63A x End Mill holder 3/4"	3/4"	1.75"	3.75"	2.22"
<b>NEW</b>	32958-6	HSK63A x End Mill holder 3/4"	3/4"	1.75"	6"	2.22"
	32962	HSK63A x End Mill holder 1.0"	1.0"	2.00"	3.75"	2.46"
<b>NEW</b>	32964	HSK63A x End Mill holder 1-1/4"	1-1/4"	2.50"	4.25"	2.51"

## HSK63F Side Lock End Mill Holders

	Part No.	Description - I.D.	d1	d2	L	l1
<b>NEW</b>	32958-4-F	HSK63F x SLN 3/4" - 4.0"	3/4"	1.75"	4.0"	4.0"
<b>NEW</b>	32962-4-F	HSK63F x SLN 1" - 4.0"	1"	2"	4.0"	4.0"
<b>NEW</b>	32838-4-F	HSK63F x SLN 25mm - 4.0"	25mm	65mm	4.0"	4.0"
<b>NEW</b>	32840-4-F	HSK63F x SLN 32mm - 4.0"	32mm	72mm	4.0"	4.0"
<b>NEW</b>	32840-F	HSK63F x SLN 32mm - 110mm	32mm	72mm	110mm	4.0"

## HSK100A End Mill Holders

	Part No.	Description - I.D.	d1	d2	L	l1
	32984	HSK100A x End Mill holder 1/2"	1/2"	1.38"	3.25"	1.97"
	32986	HSK100A x End Mill holder 5/8"	5/8"	1.63"	3.75"	2.09"
	32988	HSK100A x End Mill holder 3/4"	3/4"	1.75"	3.75"	2.22"
	32992	HSK100A x End Mill holder 1"	1"	2.00"	4.25"	2.46"
	32994	HSK100A x End Mill holder 1-1/4"	1-1/4"	2.50"	4.25"	2.51"
	32996	HSK100A x End Mill holder 1-1/2"	1-1/2"	2.75"	4.50"	2.93"
	32998	HSK100A x End Mill holder 2"	2"	3.75"	5.50"	3.53"