

EZ-Lift Magnets – sPINner Small Parts Deburring

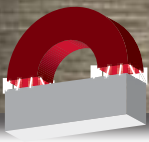



EZ-Lift Material Handling Magnets

Features

- Safety Factor 3.5X above max rating
- Lift flat or round stock
- Capacity up to 6,600 lbs, ...higher with spreader bars

Benefits

- Will not wear out like straps/slings
- Less risk of pinched fingers or toes
- Much faster setup and transport



Best Safety Factor Available

All our lifting magnets have a safety factor of 3.5 times the maximum rated load.



ELM-100 (right) weighs 5.5 lbs. and lifts 220 lbs.



Watch live demonstration video for more information.

Scan QR code or visit: <http://ow.ly/t0hUB>

Smallest, Most Powerful Lifter – With The Industry’s Best Safety Factor (3.5 X Above Maximum Rated Load)

ELM lifters feature super-powerful rare-earth neodymium iron boron lifting magnets that require no electricity and have dozens of uses. Load and unload plate, block, or round steel and iron stock. Use them on press molds, machined parts, and other ferrous materials. Use spreader bars to lift large material.

How It Works:



Lever in the "ON" position engages safety lock.



The "OFF" position.

Each ELM lifting magnet contains super powerful rare earth magnets arranged in 3 rows. The OFF position is when the magnetic poles are in alignment as shown (top left).

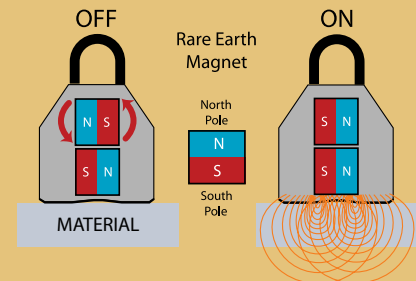

Turning the lever to the ON position rotates the center row of magnets 180° so the poles alternate, creating a powerful magnetic field.

Never attempt to turn the magnet ON unless it is placed on a correctly sized piece of material to be moved, or you may cause injury to yourself, or the ELM lifting magnet. Always follow all instructions carefully.

The Old Way: Material Handling

A) Risk of Injury

Risk of injury to back, fingers, or toes when moving material in order to position sling or chain.

B) Slings & Chains Wear Out

Lifting equipment needs to be recertified and replaced periodically.

C) Lost Productivity

It takes time to properly setup slings or chains to safely move materials.

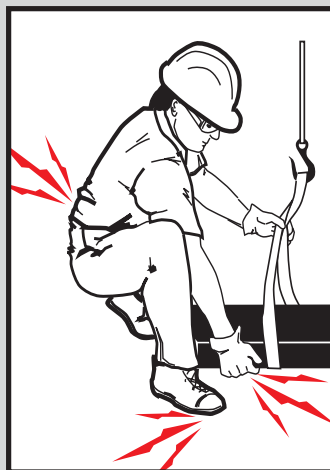

EZ-Lift Application Examples

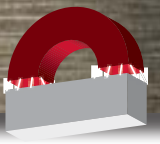

3.5 X Safety Factor above rated load capacity



Workpiece transport is faster with EZ-Lift.



Use to setup CNC machining centers.



Use spreader bars for long, difficult round stock



Center magnet on most workpieces to lift.



Beveled bottom surface lifts round stock.



Eliminate straps, slings and associated dangers.



Locate magnet at balance point for lifting.



Use spreaderbars to gang stock in one operation



Vertical Lifters can be operated by one person.



Move round or rectangular stock vertically.



Spreader bars are used for long or very heavy loads.



EZ-Lift Magnets Ordering Information

EZ-Lift Capacities – Plate & Round Steel

CAUTION: Follow all directions in the Operating Instructions that comes with your magnet.

Refer to the instructions for Calculating Maximum Loads on the next page to determine required size.

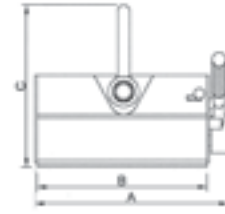
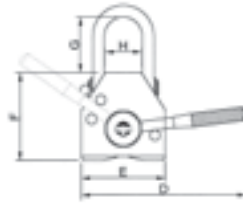

Part No.	Plate	Round	A	B	C	D	E	F	G	H	Weight
ELM-100	220 lbs.	99 lbs.	4.2"	3.3"	4.7"	4.9"	2.4"	2.8"	1.6"	1.2"	5.5 lbs.
ELM-300	660 lbs.	300 lbs.	7.1"	6.1"	6.1"	7.3"	3.6"	3.7"	2.0"	1.6"	18.9 lbs.
ELM-600	1,320 lbs.	600 lbs.	10.0"	8.8"	8.3"	10.2"	4.5"	4.7"	3.0"	2.0"	46 lbs.
ELM-1000	2,200 lbs.	990 lbs.	11.0"	9.6"	11.3"	14.6"	6.5"	6.7"	3.8"	3.4"	101 lbs.
ELM-2000	4,400 lbs.	1,980 lbs.	16.6"	15.0"	13.7"	20.2"	8.5"	8.5"	4.1"	4.8"	259 lbs.
ELM-3000	6,600 lbs.	2,970 lbs.	22.3"	20.9"	15.7"	30.3"	8.5"	8.7"	5.8"	3.2"	399 lbs.

EZ-Lift Spreader Bars

- Better for unbalanced loads
- Use with multiple magnetic lifters
- Lifter span adjustable



Control large or irregular loads during transport. Increase lifting power by adding more magnets. Includes bar, 1 upper and 2 lower S.P.A. shackles. Order magnets separately.

Keeps large materials balanced for safer transport.

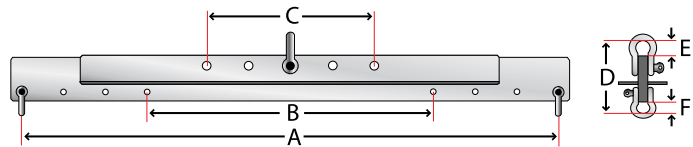

Part No.	Capacity	A	B	C	D	E	F	Weight
ELM-SB250	250 lbs.	36"	18"	12"	5.1"	1.25"	.85"	20 lbs.
ELM-SB500	500 lbs.	46"	22"	16"	5.7"	1.35"	1.34"	25 lbs.
ELM-SB1000	1,000 lbs.	72"	36"	24"	6.9"	1.35"	1.34"	65 lbs.
ELM-SB2000	2,000 lbs.	72"	36"	24"	7.3"	2.02"	1.35"	115 lbs.
ELM-SB4000	4,000 lbs.	77"	41"	24"	10.5"	2.43"	1.63"	195 lbs.
ELM-SB8000	8,000 lbs.	96"	48"	24"	12.3"	2.94"	1.78"	300 lbs.
ELM-SB10000	10,000 lbs.	116"	56"	24"	14.7"	3.5"	1.65"	600 lbs.
ELM-SB13500	13,500 lbs.	140"	68"	36"	17.1"	4.0"	2.02"	880 lbs.

EZ-Lift Vertical Lifters

- Fast loading for vertical transport
- One person can load and unload
- No dangerous straps & slings



Used for vertical transport of plate stock. Includes ELM lifting magnet.



Plate Size L x W x H (min/max)

Part No.	Size L x W x H	Capacity	Weight	L	W	H
ELM-300V	37.5" x 8.5" x 10"	660 lbs.	57 lbs.	8"/60"	11.8"/31.5"	0.25"/5.9"
ELM-600V	46" x 11" x 10"	1,320 lbs.	86 lbs.	12"/72"	11.8"/39.4"	0.31"/9.8"
ELM-1000V	48" x 14" x 12"	2,200 lbs.	128 lbs.	12.5"/79"	11.8"/39.4"	0.39"/11.8"

Position lifter on stock and turn the lever to the on position. Hoist into vertical position for transport. Always follow operating instructions included.

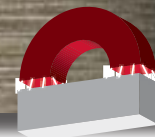

Instructions for Calculating Maximum Load by Material Type

$$T \text{ (thickness)} \times F \text{ (finish)} \times M \text{ (material)} \times \text{Capacity} = \text{ML}$$

Example: (ELM-600/plate steel) 2" (T=100%) x F2(100%) x M2 (85%) x 1,320 lbs. = **1,122 lbs.**

Calculating Maximum Loads

Calculate that the magnet will safely lift your material. Maximum Load (ML) is different for plate and round materials, and also depends upon stock thickness, carbon content, and surface finish. Follow the instructions and use the tables to calculate ML for your material type.

Rated Capacity

Part No.	Plate Steel*
ELM-100	220 lbs.
ELM-300	660 lbs.
ELM-600	1,320 lbs.
ELM-1000	2,200 lbs.
ELM-2000	4,400 lbs.
ELM-3000	6,600 lbs.

Part No.	Round Steel*
ELM-100	99 lbs.
ELM-300	300 lbs.
ELM-600	600 lbs.
ELM-1000	990 lbs.
ELM-2000	1,980 lbs.
ELM-3000	2,970 lbs.

M Lifting Power by Material

Carbon Content	Lifting Power		
	0%	50%	100%
M1 Low Carbon			100%
M2 Moderate Carbon			85%
M3 High Carbon			75%
M4 Cast Iron			70%

F Effect of Surface Finish

Surface Finish	Lifting Power			
	0%	50%	100%	150%
F1 Ground Surface				125%
F2 Rough Machined			100%	
F3 Foundry Finish			90%	
F4 ~ Rough Cast			65%	

T Equals Percent of Lifting Power by T (thickness)

T	ELM-100	ELM-300	ELM-600	ELM-1000	ELM-2000	ELM-3000
2 3/8" (60mm)	100%	100%	100%	100%	100%	100%
2 1/8" (55mm)	100%	100%	100%	100%	100%	95%
2.0" (50mm)	100%	100%	100%	100%	95%	90%
1 3/4" (45mm)	100%	100%	100%	100%	90%	85%
1 1/2" (40mm)	100%	100%	100%	100%	85%	80%
1 3/8" (35mm)	100%	100%	100%	90%	75%	70%
1 1/8" (30mm)	100%	100%	100%	80%	65%	60%
1.0" (25mm)	100%	100%	90%	70%	55%	50%
3/4" (20mm)	100%	90%	75%	60%	45%	40%
1/2" (15mm)	100%	70%	60%	50%	35%	30%
3/8" (10mm)	70%	50%	45%	35%	25%	20%
1/4" (5mm)	40%	30%	25%	20%	15%	10%

*Follow all directions in the Operating Instructions that comes with your magnet.

Custom Lifting Solutions

Engineered to meet your requirements
Call (800) 597-3921 for a fast quote

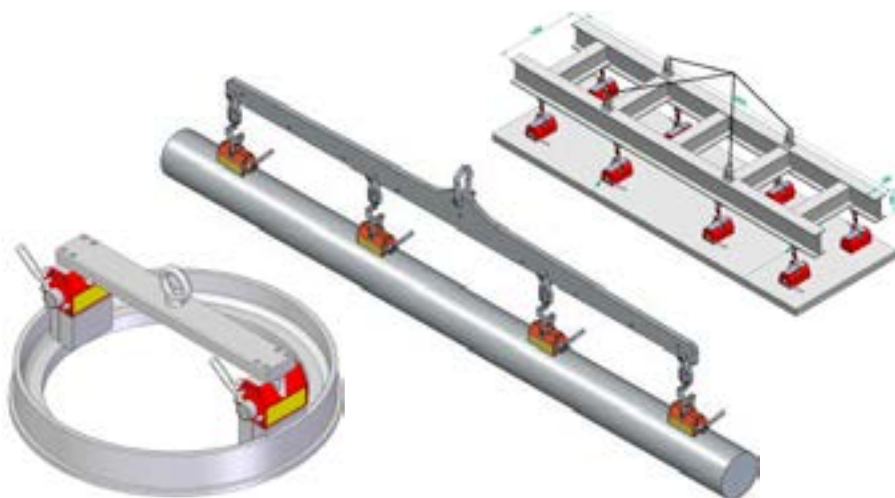
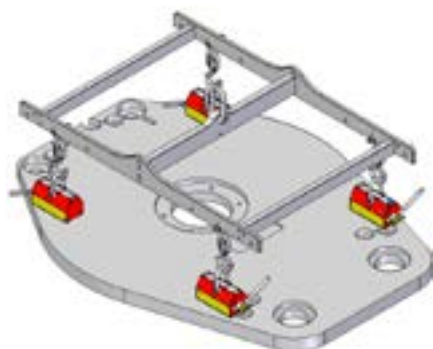



sPINner Small Parts Deburring

The sPINner batch deburrs small parts and eliminates time-consuming hand deburring. Send us your parts for complimentary testing or a deburring services quote.

Applications

- medical parts - swiss turned
- drilled or threaded parts
- machined or stamped parts

Benefits

- costs less than hand deburring
- deburr parts faster & better
- improve quality of parts



before

after

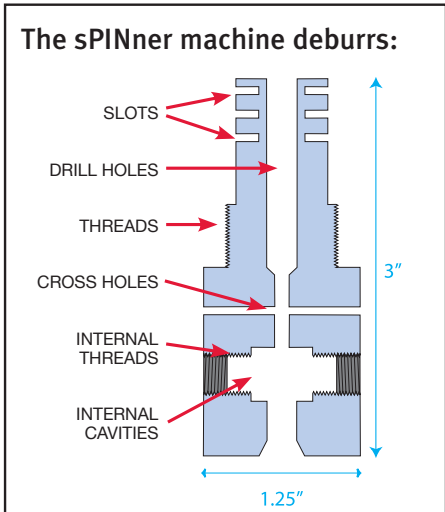

Hand Deburring Small Parts

A) Time Consuming

Hand deburring is a labor intensive process

B) Production Bottleneck

Hand deburring puts a limit on your productivity

C) Expensive

Hand deburring requires costly manual labor



Batch Deburring Small Parts

A) Deburr Faster & Better

Improve part quality and get more consistent results

B) Speed Up Production

Batch deburr dozens, hundreds, or thousands of parts in minutes

C) Reduce Cost-per-part

Eliminate expensive hand deburring costs



Reduce Your Small Parts Deburring Costs



Send us your part samples for complimentary deburring testing

Techniks sPINner Deburring • 9930 East 56th St., • Indianapolis, IN 46236

We will deburr your parts and provide a full test report or a deburring services quote.

Aluminum Gear Application

Burrs and rough edges. Deburred part in only 10 minutes.

Part Dimensions: 1 9/16" diameter x 5/16" high.

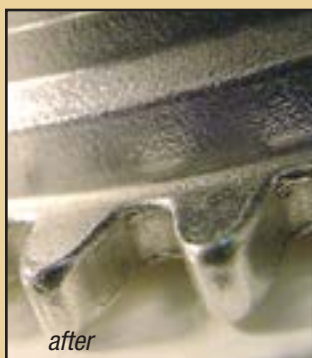

Complex Turned & Machined Aluminum

Burrs on O.D. and in I.D. slots. Batch deburring in only 10

minutes! Part Dim.: 3/16" diameter x 1 3/16" long.



Stainless Steel Turned and Machined Part

Internal cavity burrs left in cross-drilled holes

Eliminated costly hand deburring and improved quality.

Part Dimensions: 3/4" diameter x 1 7/16" long.

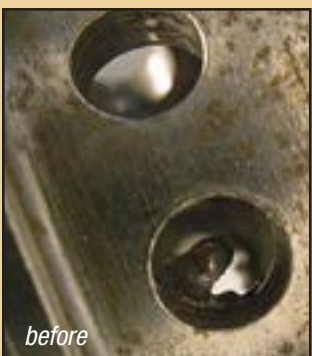

0.01" Diameter Slot in Light Alloy Collar

Fine burrs in hard-to-reach slotted area. Eliminated part

quality problem and saved labor costs. Part Dimensions: 1 7/32" diameter x 1/8" high.



The sPINner features special pin media that deburrs both internal and external part features



Stainless steel pin media reaches burrs other media can't touch.

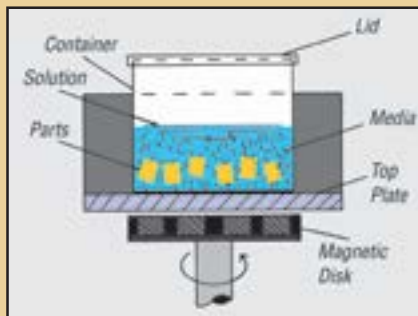

Rotating magnetic field activates pins, creating a gentle deburring action.



sPINner deburrs parts like these. Send us your parts for a complimentary test.



sPINner Small Parts Deburring Machines

sPINner Machine Includes

- sPINner pin media and deburring container
- Deburring solution and media separating sieve
- Operation manual



Use multiple containers to increase the number of parts you can deburr in one cycle.



sPINner deburring is gentle and safe and the operator can pull parts by hand during operation to check deburring progress.

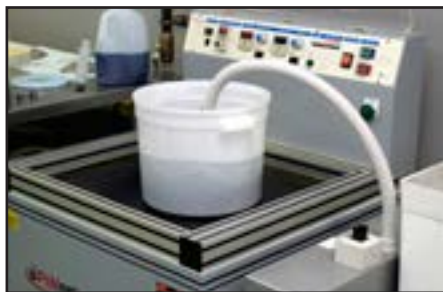

Filtration system reduces the need for changing deburring solution, so production time is optimized and parts are sparkling clean.



EHD-728



EHD-765

high-capacity machine

Each sPINner features adjustable speed / intensity controls and automatic timers for each direction. Controls are intuitive and easy to use.



Choose the sPINner machine that fits your needs. Typical deburring cycles are only 15-20 minutes, and all sPINner machines allow variable intensity and duration of deburring cycles using the programmable control panel.

You can also increase or decrease the deburring action by changing the diameter and length of media. Choose the size required for your part from the table on the next page.

For high-volume, continuous cycle deburring we recommend EDH-SFS200 filtration system. (left)



sPINner pin media can deburr holes and internal part features other media cannot reach.

Part No.	L x W x H	Tank Size L x W	Container Size W x H	Power Supply	Amps	Weight
EHD-716	10.5" x 9" x 11.5"	6.25" x 6.25"	-	110V	-	36 lbs.
EHD-728	19" x 19" x 37"	11" x 11"	9" x 8"	220V Single Phase	5	160 lbs.
EHD-735	23" x 26" x 34"	15" x 16"	13" x 9"	220V Single Phase	10	220 lbs.
EHD-750	29" x 30" x 36"	21" x 23"	19" x 10"	220V Single Phase	15	385 lbs.
EHD-765	37" x 39" x 43"	29" x 26.75"	25" x 10"	220V Single Phase	10	516 lbs.
EDH-SFS200	SFS filtration system for high-volume deburring applications					



Vibratory Parts & Media Separator



- Quickly separates parts from media
- Speeds production

Part No.	L x W x H	Power	Weight
ESS-660	18" x 18" x 26"	110/220VAC	97 lbs.

High-Capacity Parts & Media Separator



- Magnetic attraction separates media from parts—FAST!
- Handles large batches of parts easily

Part No.	L x W x H	Container L x W x H	Power	Weight
HD-712	28" x 21" x 26"	26" x 17.75" x 9.5"	110/220VAC 5A	163 lbs.

sPINner Stainless Steel Pin Media



sPINner stainless pin media lasts for years

Part No.	diameter x length
EHD-S1	0.2mm x 5mm
EHD-P1	0.3mm x 3mm
EHD-S2	0.3mm x 5mm
EHD-S13	0.3mm x 7mm
EHD-P2	0.4mm x 3mm
EHD-S3	0.4mm x 5mm
EHD-P3	0.5mm x 1mm
EHD-P4	0.5mm x 3mm
EHD-S4	0.5mm x 5mm
EHD-P5	0.7mm x 3mm
EHD-S5	0.7mm x 5mm
EHD-P6	0.8mm x 3mm
EHD-S6	0.8mm x 5mm

Our special stainless steel media is the reason the sPINner can deburr where other media is ineffective. Each SUS 304 stainless steel pin is hardened to HRC 30 and features a magnetic treatment to enhance deburring action.

To deburr hard materials like stainless steel, steel, etc., use a diameter of media bigger than 0.5mm. Use sizes less than 0.5mm for soft material like brass, copper, aluminum, gold, etc. If you want to deburr small holes, choose a diameter of pin media that is smaller than the hole. 3mm length media will work better for small holes and crevices. Choose larger pins for harder material or to increase the deburring action on stubborn burrs.

Part No.	diameter x length
EHD-P7	1.0mm x 1mm
EHD-P8	1.0mm x 3mm
EHD-S7	1.0mm x 5mm
EHD-A1	1.0mm x 7mm
EHD-P41	1.0mm x 10mm
EHD-P10	1.2mm x 3mm
EHD-S8	1.2mm x 5mm
EHD-P42	1.2mm x 10mm
EHD-P9	1.5mm x 3mm
EHD-S9	1.5mm x 5mm
EHD-A3	1.5mm x 7mm
EHD-P43	1.5mm x 10mm
EHD-S10	2.0mm x 5mm

Do You Need Deburring Help Now?



Are you looking for a source to deburr small parts? We offer deburring services from our Indianapolis location at very competitive rates.

Call (800) 597-3921 and ask to speak to a representative. We will test run your parts and send you results next day with an estimate.

Call (800) 597-3921 for deburring

PFS-747 Deburring Solution

It is important to use the proper mix of deburring solution to facilitate part deburring and cleaning parts. Use PFS-747 with all sizes of sPINner media. Dilute to a 50:1 ratio with water.



Part No.	Description
PFS-747	1/2 gallon deburring solution
PFS-7475G	5 gallons deburring solution

"One Twist" Indicator Arms (hydraulic and mechanical)

ECE Indicator Arms Features

- "One Twist" 360° adjustable joints
- Check concentricity on bench or your machine
- Powerful magnetic base

Advantages of Hydraulic Arms

- Hydraulic arms are faster, stronger, and more precise than mechanical joints
- Hydraulic joints make fine adjustments easy because they don't lose position when loosened like mechanical arms



Indicator Arms are used to check concentricity on bench or machine. Dial Indicators not included.

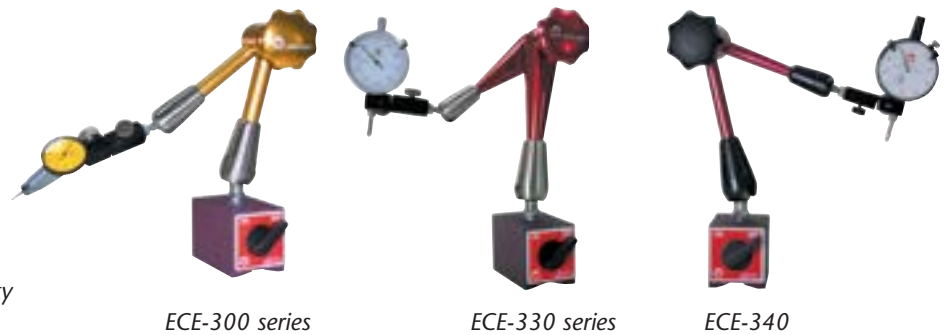

Part No.	Description	Arm Length	Base Dim. Lmm x Wmm x H	Holding Power	Weight lb
ECE-300ALL	Precision hydraulic arm, gold	23 1/2"	4 3/4"mm x 2"mm x 2 1/8"	352 lbs.	7.75
ECE-300AL	Precision hydraulic arm, gold	16 3/4"	3 1/8"mm x 2"mm x 2 1/8"	220 lbs.	5.5
ECE-300B	Precision hydraulic arm, gold	13 3/8"	2 3/8"mm x 2"mm x 2 1/8"	176 lbs.	4.5
ECE-330AL	Precision mechanical arm, red	16 3/4"	3 1/8"mm x 2"mm x 2 1/8"	220 lbs.	5.0
ECE-330B	Precision mechanical arm, red	13 3/8"	2 3/8" x 2" x 2 1/8"	176 lbs.	3.75
ECE-340	Standard mechanical arm, red	13 3/8"	2 3/8" x 2" x 2 1/8"	176 lbs.	3.5