

Proudly Manufactured in the USA

VIKING

DRILL & TOOL[®]

America's Finest High-Speed Steel Cutting Tools[®]



Twist Drills

Jobber Length NAS 907B

Heavy Duty 135° Split point

NEW Type 240-CN CN-TECH™ Cryo Nitride	6
Type 240-UB Heavy Duty Ultra Bor.	6 - 7
Type 643-UB	8 - 9
*Type 278-UB 3/8" Shank	7
Type 240-A Black Oxide	10 - 11
*Type 248-A V-Line Black Oxide	15
Type 240-AN Titanium Nitride	10 - 11
Type 240-ACN Titanium Carbon Nitride	12 - 14
Type 240-ALN Aluminum Titanium Nitride	12 - 14
*Type 240-GF GoldStrike™ 3-Flats	15
*Type 240-GFR GoldStrike™ 3/8" RS	15
* Not NAS907B	

Mechanic Length 135° Split point

Type 250-UB	28
Type 258-UB Ultra Bor 3/8" Shank	28
Type QR-UB Ultra Bor 1/4" Hex Shank	29
NEW Type QR-UB Extensions 3", 6", 12"	29
Type 241-A V-line Black Oxide	28

Jobber Length NAS 907A

Type 340-A Black Oxide 118° Split point	16
---	----

Jobber Length

General Purpose 118° point

Type 240-B Bright Finish	17 - 21
Type 643-W Metric - Bright Finish	22
Type 278 3/8" RS Bright Finish	23
Type 240-BN Titanium Nitride	17 - 21
Type 240 Black Oxide	17 - 21
Type 643 Metric - Black Oxide	22

Taps & Dies

HSS Spiral Point Taps

Type 20-UB Fractional / Machine Screw	55
Type 20-UBN Fractional / Machine Screw	55
Type 20 Fractional / Machine Screw	55
Type 21-UB Metric	55
Type 21-UBN Metric - Titanium Nitride	55
Type 21 Metric	55

HSS Straight Flute Taps

Type 23-UB Taper	58 - 60
Type 23-UBN Taper - Titanium Coated	58 - 60
Type 23 Taper	58 - 60
Type 24-UB Plug	58 - 60
Type 24-UBN Plug - Titanium Coated	58 - 60
Type 24 Plug	58 - 60
Type 25-UB Bottoming	58 - 60
Type 25-UBN Bottoming - Titanium Coated	58 - 60
Type 25 Bottoming	58 - 60
Type 26-UB Sets	61
Type 26-UBN Sets Titanium Coated	61
Type 26 Sets	61

HSS Straight Flute -Metric

Type 31-UB Taper	62
Type 31-UBN Taper - Titanium Coated	62
Type 31 Taper	62
Type 32-UB Plug	62
Type 32-UBN Plug - Titanium Coated	62
Type 32 Plug	62
Type 33-UB Bottoming	62
Type 33-UBN Bottoming - Titanium Coated	62
Type 33 Bottoming	62
Type 35-UB Sets	63
Type 35-UBN Sets Titanium Coated	63
Type 35 Sets	63

HSS Straight Flute -Left-Hand Thread

Type 23L-UB Taper	64
Type 24L-UB Plug	64
Type 25L-UB Bottoming	64

Type 248 V-Line Black Oxide	21
Type 230 Tang Drive	27

Jobber Length Parabolic 135° Split point

Type 240-P Black Oxide	25 - 26
Type 240-PT Titanium Nitride Coated	25 - 26

Jobber Length Hi-Helix 118° point

Type 240-F Bright Finish	24
------------------------------------	----

Screw Machine Length NAS 907C

Type 260-UB	35 - 36
Type 260-T Black Oxide	37
Type 260-TN Titanium Nitride Coated	37
Type 260-TW Bright Finish	37
*Type 260-QT 1/4" Reduced Shank	36
* Not NAS907B	

Screw Machine Length 118° point

Type 260 Bright Finish	38 - 39
Type 260-BN Titanium Nitride	38 - 39
1/4" Shank 118°	
Type 275	23

Drill Blank

Type 240-DB Fully Hardened - Precision Ground	50
---	----

Jobber Length Cobalt NAS 907J

Type 240-D M42 135° Split point	30
Type 240-DN M42 Titanium Nitride Coated	30
Type 240-ANDM42 Titanium Aluminum Nitride NEW	30
Type 643-D M42 Metric - 135° Split point	31

DIN Length Wide Land Parabolic Cobalt

Type XGT-J M42 135° Split point	32 - 33
Type XGT-N M42 135° SP TiN Coated NEW	33

Screw Machine Length Cobalt

Type 260-D M42 135° Split point	34
Type 260-DN M42 Titanium Nitride	34
Type 260-AND M42 Titanium Aluminum Nitride NEW	34

HSS Combination Drill & Tap **NEW**

Type 40-UB	65
Type 40-QR	65

Drill & Tap Combo

Type 34-UB	65
----------------------	----

HSS Hex Dies

Type 27-UB	66
Type 27-UB Metric	66

Hi-Performance Reduced Neck

Type 29-UB	56
Type 29-UBN - Titanium Coated	56
Type 29-ACN - Titanium Carbon Nitride	57
Type 29-ALN - Aluminum Titanium Nitride	57

M42 Cobalt Taps & TiN Coated

Type 24-RNC	58
Type 24-RNCN NEW	58

Taper Pipe Taps

Type 30-UB	63
Type 30-UBN - Titanium Nitride	63
Type 30-B Black Oxide	63
Type 30 Bright	63
Type 130-UB Interrupted	63
Type 130-UBN TiN Coated - Interrupted	63
Type 130-B Black Oxide - Interrupted	63
Type 130 Bright - Interrupted	63

HSS Tap & Drill Sets

SF-18TDC Straight Flute	65
SF-18TDF Spiral Flute	65
SP-10TD Straight Point	65
SP-12TD Spiral Point	65
SP-18TD Spiral Point	65
SP-18TDM Spiral Point	65

HSS Tap Sets

SP-19T Spiral Point	66
SP-10T Spiral Point	66
SF-10T Straight Flute	66

Drill, Tap & Countersink Set **NEW**

TDC-12	66
------------------	----

Silver & Deming 1/2" Shank

Type 280-UB 135° Split point	45
Type 280-UBM Metric - 135° Split point	46
Type 280-UBX 118° Split point 3 - Flats	45
Type 280-MRO Mechanic Length 135° SP	47
Type 280 118° point - Round Shank	46
Type 280-D M42 135° Split point	47
Type Ext - Extension OAL- 7-1/2"	47

Silver & Deming 3/4" Shank

Type 281-UB 135° Split point-Round Shank	46
--	----

Taper Length

Type 210 118° point - General purpose	40 - 41
Type 220 118° point - Tang Drive	41
Type 221-P Parabolic - Tang Drive	42
Type 221-PT Titanium Nitride Coated 135° SP	42

Extra Length

Type XGT-UB Ultra Bor 6" 9" 12"	43
Type 200 12" - OAL 9" Flute	43
Type 208 18" - OAL 12" Flute	43

Aircraft Extension

Type 211 6"- OAL Black Oxide NAS 907B	44
Type 209-D 6"- OAL Cobalt NAS 907J	44
Type 212 12"- OAL Black Oxide	44
Type 213-D 12"- OAL Cobalt NAS 907J	44

Taper Shank

Type 510 - Regular Shanks	48 - 49
Type 520 - Larger than Standard	49
Type 500 - Smaller than Standard	49

Technical Reference 51 - 53

HSS Tap & Die Assortments

Ultra Bor Super Premium	
14pc, 23pc Metric	67
15pc, 25pc	67
40pc, 58pc	68

Hi-Carbon Steel Taps

Type 720 Plug - Fractional	69
Type 721 Plug - Machine Screw	69
Type 740 Taper - Fractional	69
Type 741 Plug - Machine Screw	69
Type 760 Bottoming - Fractional	70
Type 761 Bottoming - Machine Screw	70
Type 722 3 pc - Fractional Set	70
Type 723 3 pc - Machine Screw	70
Type 780 Plug Taps - Metric	73

Hi-Carbon Steel Pipe Taps

Type 410 Fractional	73
-------------------------------	----

Hi-Carbon Steel Dies

Type 400 - Round	72
Type 405 - Hex	71
Type 415 - Adjustable	72
Type 790 - Hex Metric	71

Hi-Carbon Tap & Die Sets

Type 724	
14pc, 16pc	74
24pc, 37pc	75
40pc	76

Tap & Reamer Wrenches / Die Stocks

Type 725, 726, 727	77
Type 727R Ratcheting T-Handle NEW	77
Type 728	78
Type 729	78
Type 730	78

Technical Reference 79 - 83

Magnetic Base Drills & Annular Cutters

Annular Cutters

Type 14 & 14L M35 Cobalt	86
Type 15 & 15L M42 Cobalt	86
Type 13SP & 13LSP M2 HSS	86

Counter Display High-Speed Steel

Annular Sets	87
Counter Displays	87

Spira-Broach™

MBD 4500	85
MBD 5500	85
MBD 6500	85
MBD 7000	85

Specialty Tools

Acrylic Drills

Type 183-UB	98
-------------	----

Auger Bits

Type 940, 941 & 942	94
Type 950, 951 952 & 953	94

Bell Hanger Bits

Type 601	97
----------	----

Bolt Remover

Bolt Extractors Set	91
Type 420 Spiral	90
Type 421-UB Square	90

Brad Point Drills

Type 16-UB	95
Type 16-UB Sets	95

Carbide Tipped Hole cutters

Type CHC-UB	99
Type CHD-UB	99
Type CHC-QR	99
Type Ext OAL- 6-1/4"	99
Hanging Display for CHC-QR	99

Countersinks

Type 82-UB	100
Type 90-UB	100
Technical Diagram	101

Combined Drills & Countersinks

Type 296	101
Combined Drill and Counter-Sink Set	101

Cutting Tool Lubricant

Type 11-UB	98
------------	----

Glass & Tile Drills

Type 626	91
----------	----

Hard Steel Drills

Type 602 Carbide Tipped	98
Type 602-C Solid Carbide	98

Reamers

Type 50-UB Car Reamers	92
Type 51-UB Car Reamers	92
Type 52-UB Hex Bridge length	92
Type 53-UB Hex Car length	92
Type 54-UB Taper Shank	93
Type 55-UB Taper Shank	93
Type 284-UB Hole-Hog™	93
Type 284-UB Hole Hog™ Sets	93

Left-Hand Spiral Drills

Type 420-AL Carded	89
Type 240-AL	89
Type 240-AL Sets	89

Pilot Drills

Type 491	97
----------	----

Power Bits

Type 935	95
Type 935 Sets	95
Type QR-UB Extensions 3", 6", 12"	95

Sheeters Drills

Type 213	98
----------	----

Step Drills - Multi-Diameter

Type 78-UB	96
Type 78-UBN	96
Type 78-QR	96
Type 78-QRN	96
Step Drill Sets	96

Twin End Drills

Type 490-G	97
Type 490	97

Weldout™ Spot weld Drills & Sets

Type 492-D Weldout™ Spot weld	102
Type 493-D Weldout™ Spot weld	102
Type 493-DN TiN Coated	102
Type 493-DB Carbide ALTiN Coated	102
Type 493-D WO-4 Set	102
Type 492-D WO-6 Set	102

Premium Carbide Burrs

SA Style

Cylinder Shape - No End Cut	104
-----------------------------	-----

SB Style

Cylinder Shape - with End Cut	104
-------------------------------	-----

SC Style

Cylinder Shape - Radius End	105
-----------------------------	-----

SD Style

Ball Shape	105
------------	-----

SE Style

Oval / Egg Shape	106
------------------	-----

SF Style

Tree Shape Radius	106
-------------------	-----

SG Style

Pointed Tree Shape	107
--------------------	-----

SH Style

Flame Shape	107
-------------	-----

SJ Style

60° Cone Shape	107
----------------	-----

SK Style

90° Cone Shape	107
----------------	-----

SL Style

Taper Shape Radius - 14° Included Angle	107
---	-----

SM Style

Pointed Cone Shape	108
--------------------	-----

SN Style

Inverted Cone Shape	108
---------------------	-----

Premium Carbide Burrs Sets

Double Cut Sets

Set A - 9pc	108
Set B - 9pc	108
Set C - 9pc	108
Set D - 9pc	108
Set E - 8pc	108
Set F - 8pc	108

Double Cut Display

48 pc.	
Double Cut- 1/8" Shank	108
Double Cut- 1/4" Shank	108
Aluma Cut- 1/4" Shank	108

24 pc.

Double Cut- 1/4" Shank	108
------------------------	-----

Cutting Tool Sets

Jobber Length NAS 907B Heavy Duty 135° Split point

NEW Type 240-CN CN-TECH™ Cryo Nitride . . .110

Type 240-UB Heavy Duty110

Type 643-UB Metric110

***Type 278-UB 3/8" Shank110**

Type 240-A Black Oxide 112 - 113

***Type 248-A V-Line Black Oxide.114**

Type 240-AN Titanium Coated 112 - 113

Type 240-ACN Titanium Carbon Nitride . . 112 - 113

Type 240-ALN 112 - 113

***Type 240-GF GoldStrike™ 3-Flats114**

***Type 240-GFR GoldStrike™ 3/8" RS . . .114**

*** Not NAS907B**

Mechanic Length 135° Split point

Type 250-UB111

Type 258-UB 3/8" Shank111

Type QR-UB 1/4" Hex Shank111

Type 241-A V-line Black Oxide122

Jobber Length General Purpose 118° point

Type 240-B Bright Finish 117 - 120

Type 278 3/8" RS Bright Finish 117 - 119

Type 240-BN Titanium Nitride Coated . . 117 - 119

Type 240 Black Oxide 117 - 119

Type 643 Metric - Black Oxide 117 - 119

Type 248 V-Line Black Oxide 117 - 118

Jobber Length Parabolic 135° Split point

Type 240-P Black Oxide121

Type 240-PT Titanium Nitride121

Screw Machine Length NAS 907C

Type 260-UB120

Type 260-T Black Oxide123

Type 260-TN Titanium Nitride Coated . . 123

*** Not NAS907C**

Screw Machine Length 118° point

Type 260 Bright Finish122

Type 260-BN Titanium Nitride Coated . . 122

1/4" Shank 118°

Type 275120

Jobber Length Cobalt NAS 907J

Type 240-D 135° Split point 115 - 116

Type 240-DN Titanium Nitride Coated . . 115 - 116

Type 643-D Metric - 135°SP 116

Screw Machine Length M42 Cobalt

Type 260-D 135° Split point 120

Silver & Deming 1/2" Shank

Type 280-UB 135° Split point124

Type 280-UBX 118° Split pt 3-Flats . . .124

Type 280-D 135° Split pt 3-Flats124

Type 280-MRO 135° Split Point124

Type 280 118° point - Round Shank . . .124

Step Drills

Type 78-UB127

Type 78-UBN127

Type 78-ACN127

Type 78-QR127

Type 78-QRN127

Acrylic Drills

Type 183-UB Super Chipfree™ pt.122

Combination Drill & Tap

Type 40-UB126

Weldout™ Spot weld Drills

Type 493-D WO-4125

Type 492-D WO-6125

Left Hand Spiral

Type 240-AL125

Brad Point Drills

Type 16-UB125

Tap & Drills

B-18TD126

SP-18TD126

SP-18TDM126

SP-18TDF126

SP-12TD126

SF-18TDC126

SF18TDF126

SF-10TD126

Bolt Extractor

BR-8 Left Hand Drill Bolt Extractor127

BR-10 Left Hand Drill Bolt Extractor127

SE-4N Bolt Extractor-Spiral Extractor . . .127

SE-5N Bolt Extractor-Spiral Extractor . . .127

BR-8SQ Left Hand - Bolt Extractor127

SQE-4 Bolt Extractor-Spiral Extractor . . .127

ChatterProof™ Counter sink

Type 82-UB Countersink127

Type 90-UB Deburring Tools127

Hole Expansion Tools

Type 50-UB Standard Flute128

Type 51-UB Fast Spiral128

Hole Hog™

Type 284-UB128

Carbide Hole Cutters

Type CHC-UB & CHD-UB128

3pc CHC-UB **NEW**128

Displays, Cabinets & Indexes

Annular Cutter Sets132

Counter Displays

Annular Cutter131

Reamers132

Type 50-UB & Type 51-UB

Silver & Deming131

Stock Master Dispensers & Displays

Type 925 300pc. Fractional130

Display Packages

Type 250-UB140

Type CHC-UB & CHD-UB140

Drill Gauges

Type 913 Letter, Fractional & Wire137

Drill Stand

Type 913 Letter, Fractional & Wire137

Indexes

Type 901 Indexes Only141

Type 901 Black Indexes - ID Plate Slot . . .142

Master Drill Dispensers

Type 913 U.S. & Metric Sizes135

Master Tap Dispensers

Type 913136

Silver & Deming Drill Dispensers

Type 913134

Stocking Cases

Type 925

13 pc. Silver & Deming133

72 pc. Letter133

91 pc. Metric133

96 pc. Fractional133

249 pc. Wire133

Carbide Hole cutter Display

Type CHC-UB140

Type CHD-UB140

Tap & Die Counter tops

Tap & Round Die138

Tap & Hex Die138

Ultra Bor Super Premium

53-SF138

55-SP138

Tap & Drill Assortments Super Premium

67-SP139

123-SP139

123-SF139

Drawer-Mount Dispensers

Type 913

Fractional, Wire, Letter & Empty134

Technical Reference

Drill Bits

Decimal Equivalent & Tap Drill Sizes Chart 51

Drill Feeds & Speeds 52

Twist Drill Trouble Shooting 53

Taps & Dies

Standard Cutting Taps 79

Metric Cutting Taps 80

Tap Trouble Shooting 81

Tap Limits, Product Limits 82

Tread Constants for Various Percentages 83

WHY CHOOSE ULTRA BOR?



- ✓ **Substantially longer cutting life**
The nitro-carburized flute has an increased Rockwell hardness.
- ✓ **Cuts harder materials**
The flatter point takes a smaller chip. More torque is directed to a smaller area. This allows drilling into materials with hardness of over 30 on the Rockwell "C" scale.
- ✓ **Stops drill walking**
The split point design gives accurate starting without the use of a center punch.
- ✓ **Holds tighter hole size**
The split point design is self centering. This limits the normal oversize drilling characteristics.
- ✓ **Outstanding quality appearance**
The rich amber gold color sets it apart from commodity cutting tools.
- ✓ **Runs cooler, uses less torque**
135° point takes a smaller chip resulting in less heat. Friction is reduced by amber gold surface treatment.
- ✓ **Stops chuck slippage**
Flats on drill shanks allow easy positive chuck grip.

Why Choose Ultra Bor Super Premium

ULTRA BOR SUPER PREMIUM VS. COBALT

The **Ultra Bor Super Premium** drills will substantially outperform cobalt drills in work hardening stainless steel applications. This performance advantage is the result of construction differences between the two types of drills. Cobalt drills, manufactured to **Type J NAS 907** specs, have a very thick web. This web is necessary to limit breakage of the brittle cobalt steel. **Ultra Bor Super Premium** drills are made of special hi-moly tool steel, which is much tougher than cobalt steel. The web on an **Ultra Bor Super Premium** drill can be thinned considerably due to the toughness of the steel.

A **Ultra Bor Super Premium** drill with its thin web will penetrate the work hardening stainless fast enough to continually cut beneath the chip which is hardening from deformation. This means the drill is cutting softer steel. The cobalt drill, with its thick web, cannot be fed at a fast enough rate to cut beneath the area which is hardening. As a result the cobalt drill is continually drilling into hardened steel.

STAINLESS STEEL WORK HARDENING VS. FREE MACHINING

Work hardening grades of stainless are the 300 series with the exception of 303, which is free machining. Free machining grades include the 400 series in addition to type 303. A quick way to identify work hardening vs free machining stainless is to observe the chip formation. Work hardening chips break up during the drilling process, while free machining chips are long and stringy.

COBALT APPLICATIONS

Cobalt drills are recommended for free machining stainless (400 series & 303), titanium alloys and other high tensile strength materials. These applications require the high red hardness of cobalt steel to counter the substantial heat generated in the drilling process.

ULTRA BOR SUPER PREMIUM VS. COBALT

A **Ultra Bor Super Premium** drill with its thin web will penetrate the work hardening stainless fast enough to continually cut beneath the chip which is hardening from deformation. This means the drill is cutting softer steel.

The cobalt drill, with its thick web, cannot be fed at a fast enough rate to cut beneath the area which is hardening. As a result the cobalt drill is continually drilling into hardened steel.

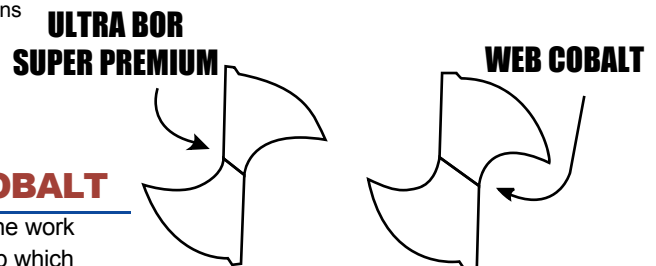

Jobber Length NAS 907B

Heavy Duty 135° Split point

NEW Type 240-CN CN-TECH™ Cryo Nitride . . .6
Type 240-UB Heavy Duty6-7
Type 643-UB8 - 9
*Type 278-UB 3/8" Shank7
Type 240-A Black Oxide10 - 11
*Type 248-A V-Line Black Oxide.15
Type 240-AN Titanium Nitride10 - 11
Type 240-ACN Titanium Carbon Nitride 12 -14
Type 240-ALN Aluminum Titanium Nitride 12 -14
*Type 240-GF GoldStrike™ 3-flats15
*Type 240-GFR GoldStrike™ 3/8" RS . . .15
* Not NAS907B

Mechanic Length 135° Split point

Type 250-UB28
Type 258-UB 3/8" Shank28
Type QR-UB 1/4" Hex Shank29
Type 241-A V-line Black Oxide28

Jobber Length NAS 907A

Type 340-A Black Oxide 118° Split point . .16

Jobber Length

General Purpose 118° point

Type 240-B Bright Finish17 - 21
Type 643-W Metric - Bright Finish22
Type 278 3/8" RS Bright Finish23
Type 240-BN Titanium Nitride17 - 21
Type 240 Black Oxide17 - 21
Type 643 Metric - Black Oxide22
Type 248 V-Line Black Oxide21
Type 230 Tang Drive.27

Jobber Length

Parabolic 135° Split point

Type 240-P Black Oxide25 - 26
Type 240-PT Titanium Nitride Coated . .25 - 26

Jobber Length Hi-Helix 118° point

Type 240-F Bright Finish24

Screw Machine Length NAS 907C

Type 260-UB35 - 36
Type 260-T Black Oxide37
Type 260-TN Titanium Nitride Coated . .37
Type 260-TW Bright Finish37
*Type 260-QT 1/4" Reduced Shank . . .36
* Not NAS907B

Screw Machine Length 118° point

Type 260 Bright Finish38 - 39
Type 260-BN Titanium Nitride38 - 39

1/4" Shank 118°

Type 27523

Drill Blank

Type 240-DB
Fully Hardened - Precision Ground50

Jobber Length Cobalt NAS 907J

Type 240-D M42 135° Split point30
Type 240-DN M42 Titanium Nitride30
NEW Type 240-AND M42 Titanium Aluminum Nitride .30
Type 643-D M42 Metric - 135° Split pt. .31

DIN Length Wide Land Parabolic Cobalt

Type XGT-J M42 135° Split point. . .32 - 33
NEW Type XGT-N M42 135° SP TiN Coated 33

Screw Machine Length Cobalt

Type 260-D M42 135° Split point34
Type 260-DN M42 Titanium Nitride Coated .34
NEW Type 260-AND M42 Titanium Aluminum Nitride .34

Silver & Deming 1/2" Shank

Type 280-UB 135° Split point45
Type 280-UBM Metric - 135° Split point . .46
Type 280-UBX 118° Split point 3 - Flats . .45
Type 280-MRO Mechanic Length 135° SP . .47
Type 280 .118° point - Round Shank . . .46
Type 280-D M42 135° Split point47
Type EXT Extension OAL- 7-1/2"47

Silver & Deming 3/4" Shank

Type 281-UB
135° Split point - Round Shank46

Taper Length

Type 210 118° pt.General Purpose . .40 - 41
Type 220 118° point - Tang Drive.41
Type 221-P Parabolic - Tang Drive.42
Type 221-PT Titanium Nitride Coated 135° SP.42

Extra Length

Type XGT-UB 6" 9" 12"43
Type 200 12" - OAL 9" Flute43
Type 208 18" - OAL 12" Flute43

Aircraft Extension

Type 211 6"- OAL Black Oxide NAS 907B . .44
Type 209-D 6"-OAL Cobalt NAS 907J44
Type 212 12"- OAL Black Oxide44
Type 213-D 12"- OAL Cobalt NAS 907J44

Taper Shank

Type 510 - Regular Shanks48 - 49
Type 520 - Larger than Standard49
Type 500 - Smaller than Standard.49

Technical Reference51- 53

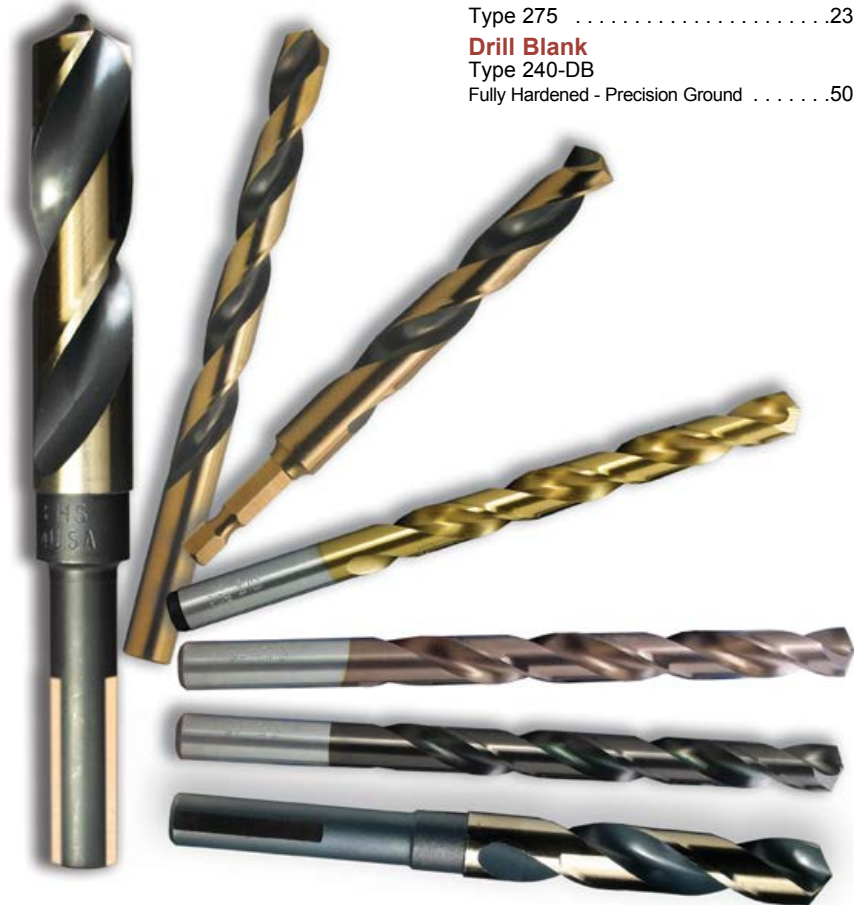

Jobber Length



HSS HEAVY-DUTY CN-TECH™ & HSS HEAVY-DUTY NAS 907B

Type 240-CN

CN-TECH™ 135° Split point



- Cryogenic treatment creates a more uniform “grain” structure by transforming retained austenite into martensite.
- Modifies the carbon micro-structure through precipitation of carbides increasing resistance to wear.
- Nitride process diffuses nitrogen into the surface to create a case hardening resulting in superior tool life and exceptional corrosion resistance.



Type 240-CN

Nitride process case hardening resulting in superior tool life and exceptional corrosion resistance.

Type 240-UB

Super Premium - 135° Split point

- Manufactured to **NAS 907B** specification from Premium Hi-Molybdenum Steel.
- Ultra Bor will substantially outperform cobalt drills in work hardening stainless steel and other tough drilling applications.
- Nitro-Carburized.



Type 240-UB

Low temperature stress relief improves lubricity and toughness.

Part No.	Diameter Inches	Overall Length Inches	Flute Length Inches	Qty. per/pack
47032	1/16	1-7/8	7/8	12
47042	5/64	2	1	12
47052	3/32	2-1/4	1-1/4	12
47062	7/64	2-5/8	1-1/2	12
47072	1/8	2-3/4	1-5/8	12
47082	9/64	2-7/8	1-3/4	12
47092	5/32	3-1/8	2	12
47102	11/64	3-1/4	2-1/8	12
47112	3/16	3-1/2	2-5/16	12
47122	13/64	3-5/8	2-7/16	12
47132	7/32	3-3/4	2-1/2	12
47142	15/64	3-7/8	2-5/8	12
47152	1/4	4	2-3/4	12
47162	17/64	4-1/8	2-7/8	12
47172	9/32	4-1/4	2-15/16	12
47182	19/64	4-3/8	3-1/16	6
47192	5/16	4-1/2	3-3/16	6
47202	21/64	4-5/8	3-5/16	6
47212	11/32	4-3/4	3-7/16	6
47222	23/64	4-7/8	3-1/2	6
47232	3/8	5	3-5/8	6
47242	25/64	5-1/8	3-3/4	6
47252	13/32	5-1/4	3-7/8	6
47262	27/64	5-3/8	3-15/16	6
47272	7/16	5-1/2	4-1/16	6
47282	29/64	5-5/8	4-3/16	6
47292	15/32	5-3/4	4-5/16	6
47302	31/64	5-7/8	4-3/8	6
47312	1/2	6	4-1/2	6

Part #	Diameter Inches	Overall Length Inches	Flute Length Inches	Qty. per/pack
05580	1/16	1-7/8	7/8	12
05590	5/64	2	1	12
05600	3/32	2-1/4	1-1/4	12
05610	7/64	2-5/8	1-1/2	12
05620	1/8	2-3/4	1-5/8	12
05630	9/64	2-7/8	1-3/4	12
05640	5/32	3-1/8	2	12
05650	11/64	3-1/4	2-1/8	12
05660	3/16	3-1/2	2-5/16	12
05670	13/64	3-5/8	2-7/16	12
05680	7/32	3-3/4	2-1/2	12
05690	15/64	3-7/8	2-5/8	12
05700	1/4	4	2-3/4	12
05710	17/64	4-1/8	2-7/8	12
05720	9/32	4-1/4	2-15/16	12
05730	19/64	4-3/8	3-1/16	6
05740	5/16	4-1/2	3-3/16	6
05750	21/64	4-5/8	3-5/16	6
05760	11/32	4-3/4	3-7/16	6
05770	23/64	4-7/8	3-1/2	6
05780	3/8	5	3-5/8	6
05790	25/64	5-1/8	3-3/4	6
05800	13/32	5-1/4	3-7/8	6
05810	27/64	5-3/8	3-15/16	6
05820	7/16	5-1/2	4-1/16	6
05830	29/64	5-5/8	4-3/16	6
05840	15/32	5-3/4	4-5/16	6
05850	31/64	5-7/8	4-3/8	6
05860	1/2	6	4-1/2	6
22210	33/64	6-5/8	4-13/16	1
22220	17/32	6-5/8	4-13/16	1
22230	35/64	6-5/8	4-13/16	1
22240	9/16	6-5/8	4-13/16	1
22250	37/64	6-5/8	4-13/16	1
22260	19/32	7-1/8	5-3/16	1
22270	39/64	7-1/8	5-3/16	1
22280	5/8	7-1/8	5-3/16	1
22290	41/64	7-1/8	5-3/16	1
22300	21/32	7-1/8	5-3/16	1
22310	43/64	7-5/8	5-5/8	1
22320	11/16	7-5/8	5-5/8	1
22330	45/64	7-5/8	5-5/8	1
22340	23/32	7-5/8	5-5/8	1
22350	47/64	7-5/8	5-5/8	1
22360	3/4	7-3/8	5-5/8	1

Larger sizes available in 280-UB section

Continued on page 7

3/8" REDUCED SHANK & HSS HEAVY-DUTY NAS 907B

Type 240-UB

LETTER - HSS Heavy-Duty NAS 907B
Super Premium - 135° Split point

Part #	Letter Size	Overall Length Inches	Flute Length Inches	Qty. per/pack
39460	A	3-7/8	2-5/8	12
39470	B	4	2-3/4	12
39480	C	4	2-3/4	12
39490	D	4	2-3/4	12
39500	E	4	2-3/4	12
39510	F	4-1/8	2-7/8	12
39520	G	4-1/8	2-7/8	12
39530	H	4-1/8	2-7/8	12
39540	I	4-1/8	2-7/8	12
39550	J	4-1/8	2-7/8	12
39560	K	4-1/4	2-15/16	12
39570	L	4-1/4	2-15/16	12
39580	M	4-3/8	3-1/16	6
39590	N	4-3/8	3-1/16	6
39600	O	4-1/2	3-3/16	6
39610	P	4-5/8	3-5/16	6
39620	Q	4-3/4	3-7/16	6
39630	R	4-3/4	3-7/16	6
39640	S	4-7/8	3-1/2	6
39650	T	4-7/8	3-1/2	6
39660	U	5	3-5/8	6
39670	V	5	3-5/8	6
39680	W	5-1/8	3-3/4	6
39690	X	5-1/8	3-3/4	6
39700	Y	5-1/4	3-7/8	6
39710	Z	5-1/4	3-7/8	6

WIRE

Part #	Wire Sizes	Overall Length Inches	Flute Length Inches	Qty. per/pack
38940	1	3-7/8	2-5/8	12
38950	2	3-7/8	2-5/8	12
38960	3	3-3/4	2-1/2	12
38970	4	3-3/4	2-1/2	12
38980	5	3-3/4	2-1/2	12
38990	6	3-3/4	2-1/2	12
39000	7	3-5/8	2-7/16	12
39010	8	3-5/8	2-7/16	12
39020	9	3-5/8	2-7/16	12
39030	10	3-5/8	2-7/16	12
39040	11	3-1/2	2-5/16	12
39050	12	3-1/2	2-5/16	12
39060	13	3-1/2	2-5/16	12
39070	14	3-3/8	2-3/16	12
39080	15	3-3/8	2-3/16	12
39090	16	3-3/8	2-3/16	12
39100	17	3-3/8	2-3/16	12
39110	18	3-1/4	2-1/8	12
39120	19	3-1/4	2-1/8	12
39130	20	3-1/4	2-1/8	12
39140	21	3-1/4	2-1/8	12
39150	22	3-1/8	2	12
39160	23	3-1/8	2	12
39170	24	3-1/8	2	12
39180	25	3	1-7/8	12
39190	26	3	1-7/8	12
39200	27	3	1-7/8	12
39210	28	2-7/8	1-3/4	12
39220	29	2-7/8	1-3/4	12
39230	30	2-3/4	1-5/8	12
92310	31	2-3/4	1-5/8	12
92300	32	2-3/4	1-5/8	12

These items are also available carded. See Price List Catalog for details.

Type 240-UB

WIRE - HSS Heavy-Duty NAS 907B
Super Premium - 135° Split point

Part #	Wire Sizes	Overall Length Inches	Flute Length Inches	Qty. per/pack
92290	33	2-5/8	1-1/2	12
92280	34	2-5/8	1-1/2	12
92270	35	2-5/8	1-1/2	12
92260	36	2-1/2	1-7/16	12
92250	37	2-1/2	1-7/16	12
92240	38	2-1/2	1-7/16	12
92230	39	2-3/8	1-3/8	12
92220	40	2-3/8	1-3/8	12
88420	41	2-3/8	1-3/8	12
88410	42	2-1/4	1-1/4	12
88400	43	2-1/4	1-1/4	12
88390	44	2-1/8	1-1/8	12
88380	45	2-1/8	1-1/8	12
88370	46	2-1/8	1-1/8	12
88360	47	2	1	12
88350	48	2	1	12
88340	49	2	1	12
88330	50	2	1	12
88320	51	2	1	12
88310	52	1-7/8	7/8	12
88300	53	1-7/8	7/8	12
88290	54	1-7/8	7/8	12
88280	55	1-7/8	7/8	12
88270	56	1-3/4	3/4	12
88260	57	1-3/4	3/4	12
88250	58	1-5/8	11/16	12
88240	59	1-5/8	11/16	12
88230	60	1-5/8	11/16	12

Type 278-UB

3/8" Reduced Shank Super Premium

- 135° split point for fast penetration and accurate starting without center punch.
- Precision ground point, flutes, body, clearance and drill diameter for the ultimate in accuracy and performance.



Type 278-UB

Recommended for use in work hardening grades of stainless steel and other hard metal drilling applications

Part #	Diameter Inches	Overall Length Inches	Flute Length Inches	Qty. per/pack
59200	25/64	5-1/8	3-3/4	6
59210	13/32	5-1/4	3-7/8	6
59220	27/64	5-3/8	3-15/16	6
59230	7/16	5-1/2	4-1/16	6
59240	29/64	5-5/8	4-3/16	6
59250	15/32	5-3/4	4-5/16	6
59260	31/64	5-7/8	4-3/8	6
59270	1/2	6	4-1/2	6
59280	17/32	6	4-1/4	1
59290	9/16	6	4-1/4	1
59300	19/32	6	4-1/4	1
59310	5/8	6	4-1/4	1

These items are also available carded. See Price List Catalog for details.

Jobber Length



NAS 907B - METRIC

Type 643-UB

Ultra Bor Super Premium -
135° Split point, NAS 907B

- 135° split point provides fast penetration and accurate starting without a center punch.
- Withstands substantially higher drilling temperatures while maintaining sharpness.



Type 643-UB

Recommended for use in work hardening grades of stainless steel and other hard metal drilling applications.

METRIC

Part #	Dia. MM	Overall Length MM	Inches	Flute Length MM	Inches	Qty. per/pack
48760	0.70	32	1-1/4	10	25/64	10
48780	0.80	35	1-3/8	13	1/2	10
48790	0.85	38	1-1/2	16	5/8	10
48800	0.90	38	1-1/2	16	5/8	10
49990	0.95	38	1-1/2	16	5/8	10
48690	0.98	38	1-1/2	16	5/8	10
48820	1.00	41	1-5/8	17	11/16	10
48750	1.05	41	1-5/8	17	11/16	10
48840	1.10	44	1-3/4	19	3/4	10
48850	1.15	44	1-3/4	19	3/4	10
23270	1.18	44	1-3/4	19	3/4	10
48860	1.20	48	1-7/8	22	7/8	10
48870	1.25	48	1-7/8	22	7/8	10
48880	1.30	48	1-7/8	22	7/8	10
48890	1.35	48	1-7/8	22	7/8	10
48900	1.40	48	1-7/8	22	7/8	10
48910	1.45	48	1-7/8	22	7/8	10
48920	1.50	48	1-7/8	22	7/8	10
48930	1.55	48	1-7/8	22	7/8	10
48940	1.60	48	1-7/8	22	7/8	10
48950	1.65	51	2	25	1	10
48960	1.70	51	2	25	1	10
48970	1.75	51	2	25	1	10
48980	1.80	51	2	25	1	10
49000	1.90	51	2	25	1	10
49010	1.95	51	2	25	1	10
49020	2.00	51	2	25	1	10
49030	2.05	54	2-1/8	29	1-5/32	10
49040	2.10	54	2-1/8	29	1-5/32	10
49060	2.20	57	2-1/4	32	1-1/4	10
49080	2.30	57	2-1/4	32	1-1/4	10
49100	2.40	60	2-23/64	35	1-3/8	10
49120	2.50	60	2-23/64	35	1-3/8	10
49130	2.60	64	2-1/2	37	1-29/64	10
49140	2.70	64	2-1/2	37	1-15/32	10
49150	2.80	67	2-5/8	38	1-1/2	10
49160	2.90	70	2-3/4	41	1-5/8	10
49170	3.00	70	2-3/4	41	1-5/8	10
49180	3.10	70	2-3/4	41	1-5/8	10
49190	3.20	70	2-3/4	41	1-5/8	10
49200	3.30	73	2-7/8	45	1-3/4	10
49210	3.40	73	2-7/8	45	1-3/4	10
49220	3.50	73	2-7/8	45	1-3/4	10
49230	3.60	76	3	48	1-7/8	10
49240	3.70	76	3	48	1-7/8	10
49250	3.80	76	3	48	1-7/8	10
49260	3.90	79	3-1/8	51	2	10

Part #	Dia. MM	Overall Length MM	Inches	Flute Length MM	Inches	Qty. per/pack
49270	4.00	83	3-1/4	54	2-1/8	10
49280	4.10	83	3-1/4	54	2-1/8	10
49290	4.20	83	3-1/4	54	2-1/8	10
49300	4.30	83	3-1/4	54	2-1/8	10
49310	4.40	86	3-3/8	56	2-13/64	10
49320	4.50	86	3-3/8	56	2-13/64	10
49330	4.60	86	3-3/8	56	2-13/64	10
49340	4.70	89	3-1/2	59	2-21/64	10
49350	4.80	89	3-1/2	59	2-21/64	10
49360	4.90	92	3-5/8	62	2-7/16	10
49370	5.00	92	3-5/8	62	2-7/16	10
49380	5.10	92	3-5/8	62	2-7/16	10
49390	5.20	95	3-3/4	64	2-1/2	10
49400	5.30	95	3-3/4	64	2-1/2	10
49410	5.40	95	3-3/4	64	2-1/2	10
49420	5.50	95	3-3/4	64	2-1/2	10
49430	5.60	98	3-7/8	67	2-5/8	10
49440	5.70	98	3-7/8	67	2-5/8	10
49450	5.80	98	3-7/8	67	2-5/8	10
49460	5.90	98	3-7/8	67	2-5/8	10
49470	6.00	102	4	70	2-3/4	10
49480	6.10	102	4	70	2-3/4	10
49490	6.20	102	4	70	2-3/4	10
49500	6.30	102	4	70	2-3/4	10
49510	6.40	105	4-1/8	73	2-7/8	10
49520	6.50	105	4-1/8	73	2-7/8	10
49530	6.60	105	4-1/8	73	2-7/8	10
49540	6.70	105	4-1/8	73	2-7/8	10
49550	6.80	105	4-1/8	73	2-7/8	10
49560	6.90	105	4-1/8	73	2-7/8	10
49570	7.00	105	4-1/8	73	2-7/8	10
49580	7.10	108	4-1/4	75	2-61/64	10
49590	7.20	108	4-1/4	75	2-61/64	10
49600	7.30	108	4-1/4	75	2-61/64	10
49610	7.40	111	4-3/8	78	3	10
49620	7.50	111	4-3/8	78	3	5
49630	7.60	111	4-3/8	78	3	5
49640	7.70	114	4-1/2	81	3-3/16	5
49650	7.80	114	4-1/2	81	3-3/16	5
49660	7.90	114	4-1/2	81	3-3/16	5
49670	8.00	114	4-1/2	81	3-3/16	5
49680	8.10	117	4-9/16	84	3-5/16	5
49690	8.20	117	4-9/16	84	3-5/16	5
49700	8.30	117	4-9/16	84	3-5/16	5
49710	8.40	121	4-3/4	87	3-27/64	5

Metric sizes continued on page 9

NAS 907B - METRIC



Type 643-UB

Recommended for use in work hardening grades of stainless steel and other hard metal drilling applications.

Type 643-UB

Ultra Bor Super Premium
- NAS 907B 135° Split point

- 135° split point provides fast penetration and accurate starting without a center punch.
- Withstands substantially higher drilling temperatures while maintaining sharpness.

METRIC

Part #	Dia. MM	Overall Length		Flute Length		Qty. per/pack	Part #	Dia. MM	Overall Length		Flute Length		Qty. per/pack
		MM	Inches	MM	Inches				MM	Inches	MM	Inches	
49720	8.50	121	4-3/4	87	3-27/64	5	12470	10.90	140	5-1/2	103	4-1/16	5
49730	8.60	121	4-3/4	87	3-27/64	5	49910	11.00	140	5-1/2	103	4-1/16	5
49740	8.70	121	4-3/4	87	3-27/64	5	12480	11.10	140	5-1/2	103	4-1/16	5
49750	8.80	124	4-7/8	89	3-1/2	5	49920	11.20	143	5-5/8	106	4-7/32	5
49760	8.90	124	4-7/8	89	3-1/2	5	50240	11.30	143	5-5/8	106	4-7/32	5
49770	9.00	124	4-7/8	89	3-1/2	5	12490	11.40	143	5-5/8	106	4-7/32	5
49780	9.10	124	4-7/8	89	3-1/2	5	49930	11.50	143	5-5/8	106	4-7/32	5
49790	9.20	127	5	92	3-5/8	5	12500	11.60	143	5-5/8	106	4-7/32	5
49800	9.30	127	5	92	3-5/8	5	50250	11.70	146	5-3/4	110	4-11/32	5
49810	9.40	127	5	92	3-5/8	5	49940	11.80	146	5-3/4	110	4-11/32	5
49820	9.50	127	5	92	3-5/8	5	12520	11.90	146	5-3/4	110	4-11/32	5
49830	9.60	130	5-1/8	95	3-3/4	5	49950	12.00	149	5-7/8	111	4-3/8	5
49840	9.70	130	5-1/8	95	3-3/4	5	12530	12.10	149	5-7/8	111	4-3/8	5
49850	9.80	130	5-1/8	95	3-3/4	5	49960	12.20	149	5-7/8	111	4-3/8	5
49860	9.90	130	5-1/8	95	3-3/4	5	50260	12.30	149	5-7/8	111	4-3/8	5
49870	10.00	130	5-1/8	95	3-3/4	5	12540	12.40	149	5-7/8	111	4-3/8	5
12450	10.10	130	5-1/8	95	3-3/4	5	49970	12.50	152	6	114	4-1/2	5
49880	10.20	133	5-15/64	98	3-7/8	5	12550	12.60	152	6	114	4-1/2	5
12510	10.30	133	5-15/64	98	3-7/8	5	12570	12.70	152	6	114	4-1/2	5
50220	10.40	133	5-15/64	98	3-7/8	5	50270	12.80	152	6	114	4-1/2	5
49890	10.50	133	5-15/64	98	3-7/8	5	12560	12.90	152	6	114	4-1/2	5
12460	10.60	137	5-3/8	100	3-15/16	5	49980	13.00	152	6	114	4-1/2	5
50230	10.70	137	5-3/8	100	3-15/16	5							
49900	10.80	140	5-1/2	103	4-1/16	5							

Larger sizes in 280-UBM section page 46

HSS HEAVY-DUTY NAS 907B

Type 240-A Black Oxide, Type 240-AN Titanium Nitride

135° Split point

- Heavy-duty construction for drilling in tougher materials
- Manufactured from premium high-speed steel
- 135° split point is self-centering for reduce thrust and easier penetration
- Manufactured to **NAS 907B** aerospace specification



Type 240-A

Black Oxide surface finish increases wear resistance and adds lubricity to improve chip flow.



Type 240-AN

Titanium nitride (TiN) coating adds lubricity and hardness, enhancing chip flow, finish hole quality and drill life.

FRACTIONAL

Type 240-A Black Oxide Part Number	Type 240-AN Titanium Nitride Part Number	Diameter Inches	Overall Length Inches	Flute Length Inches	Type 240-A Black Oxide Qty. per/Pack	Type 240-AN Titanium Nitride Qty. per/Pack
04490	97890	1/16	1-7/8	7/8	12	6
04500	97880	5/64	2	1	12	6
04510	97870	3/32	2-1/4	1-1/4	12	6
04520	97860	7/64	2-5/8	1-1/2	12	6
04530	97850	1/8	2-3/4	1-5/8	12	6
04540	97840	9/64	2-7/8	1-3/4	12	6
04550	97830	5/32	3-1/8	2	12	6
04560	97820	11/64	3-1/4	2-1/8	12	6
04570	97810	3/16	3-1/2	2-5/16	12	6
16600	97800	13/64	3-5/8	2-7/16	12	6
16610	97790	7/32	3-3/4	2-1/2	12	6
16620	97780	15/64	3-7/8	2-5/8	12	6
16630	97770	1/4	4	2-3/4	12	6
16640	97760	17/64	4-1/8	2-7/8	12	6
16650	97750	9/32	4-1/4	2-15/16	12	6
16670	97740	19/64	4-3/8	3-1/16	6	3
16680	97730	5/16	4-1/2	3-3/16	6	3
16690	97720	21/64	4-5/8	3-5/16	6	3
16700	97710	11/32	4-3/4	3-7/16	6	3
16710	97700	23/64	4-7/8	3-1/2	6	3
16720	97690	3/8	5	3-5/8	6	3
16730	97680	25/64	5-1/8	3-3/4	6	3
16740	97670	13/32	5-1/4	3-7/8	6	3
16750	97660	27/64	5-3/8	3-15/16	6	3
16760	97650	7/16	5-1/2	4-1/16	6	3
16770	97640	29/64	5-5/8	4-3/16	6	3
16780	97630	15/32	5-3/4	4-5/16	6	3
16790	97620	31/64	5-7/8	4-3/8	6	3
16800	97610	1/2	6	4-1/2	6	3

LETTER

Type 240-A Black Oxide Part Number	Type 240-AN Titanium Nitride Part Number	Letter Sizes	Overall Length Inches	Flute Length Inches	Type 240-A Black Oxide Qty. per/pack	Type 240-AN Titanium Nitride Qty. per/pack
05300	95710	A	3-7/8	2-5/8	12	6
05310	95700	B	4	2-3/4	12	6
05320	95690	C	4	2-3/4	12	6
05330	95680	D	4	2-3/4	12	6
05340	95670	E	4	2-3/4	12	6
05350	95660	F	4-1/8	2-7/8	12	6
05360	95650	G	4-1/8	2-7/8	12	6
05370	95640	H	4-1/8	2-7/8	12	6
05380	95630	I	4-1/8	2-7/8	12	6
05390	95620	J	4-1/8	2-7/8	12	6
05400	95610	K	4-1/4	2-15/16	12	6
05410	95600	L	4-1/4	2-15/16	12	6
05420	95590	M	4-3/8	3-1/16	6	3
05430	95580	N	4-3/8	3-1/16	6	3
05440	95570	O	4-1/2	3-3/16	6	3
05450	95560	P	4-5/8	3-5/16	6	3
05460	95550	Q	4-3/4	3-7/16	6	3
05470	95540	R	4-3/4	3-7/16	6	3
05480	95530	S	4-7/8	3-1/2	6	3

Letter sizes continued on page 11.

HSS HEAVY-DUTY NAS 907B

Type 240-A Black Oxide, Type 240-AN Titanium Nitride

135° Split point



Type 240-A

Black Oxide surface finish increases wear resistance and adds lubricity to improve chip flow.



Type 240-AN

Titanium nitride (TiN) coating adds lubricity and hardness, enhancing chip flow, finish hole quality and drill life.

- Heavy-duty construction for drilling in tougher materials
 - Manufactured from premium high-speed steel
- 135° split point is self-centering for reducing thrust and easier penetration
 - Manufactured to **NAS 907B** aerospace specification

LETTER

Type 240-A Black Oxide Part Number	Type 240-AN Titanium Nitride Part Number	Letter Sizes	Overall Length Inches	Flute Length Inches	Type 240-A Black Oxide Qty. per/pack	Type 240-AN Titanium Nitride Qty. per/pack
05490	95520	T	4-7/8	3-1/2	6	3
05500	95510	U	5	3-5/8	6	3
05510	95500	V	5	3-5/8	6	3
05520	95490	W	5-1/8	3-3/4	6	3
05530	95480	X	5-1/8	3-3/4	6	3
05540	95470	Y	5-1/4	3-7/8	6	3
05550	95460	Z	5-1/4	3-7/8	6	3

WIRE

Type 240-A Black Oxide Part Number	Type 240-AN Titanium Nitride Part Number	Letter Sizes	Overall Length Inches	Flute Length Inches	Type 240-A Black Oxide Qty. per/pack	Type 240-AN Titanium Nitride Qty. per/pack
04780	98520	1	3-7/8	2-5/8	12	6
04790	98510	2	3-7/8	2-5/8	12	6
04800	98500	3	3-3/4	2-1/2	12	6
04810	98490	4	3-3/4	2-1/2	12	6
04820	98480	5	3-3/4	2-1/2	12	6
04830	98470	6	3-3/4	2-1/2	12	6
04840	98460	7	3-5/8	2-7/16	12	6
04850	98450	8	3-5/8	2-7/16	12	6
04860	98440	9	3-5/8	2-7/16	12	6
04870	98430	10	3-5/8	2-7/16	12	6
04880	98420	11	3-1/2	2-5/16	12	6
04890	98410	12	3-1/2	2-5/16	12	6
04900	98400	13	3-1/2	2-5/16	12	6
04910	98390	14	3-3/8	2-3/16	12	6
04920	98380	15	3-3/8	2-3/16	12	6
04930	98370	16	3-3/8	2-3/16	12	6
04940	98360	17	3-3/8	2-3/16	12	6
04950	98350	18	3-1/4	2-1/8	12	6
04960	98340	19	3-1/4	2-1/8	12	6
04970	98330	20	3-1/4	2-1/8	12	6
04980	98320	21	3-1/4	2-1/8	12	6
04990	98310	22	3-1/8	2	12	6
05000	98300	23	3-1/8	2	12	6
05010	98290	24	3-1/8	2	12	6
05020	98280	25	3	1-7/8	12	6
05030	98270	26	3	1-7/8	12	6
05040	98260	27	3	1-7/8	12	6
05050	98250	28	2-7/8	1-3/4	12	6
05060	98240	29	2-7/8	1-3/4	12	6
05070	98230	30	2-3/4	1-5/8	12	6
05080	98220	31	2-3/4	1-5/8	12	6
05090	98210	32	2-3/4	1-5/8	12	6
05100	98200	33	2-5/8	1-1/2	12	6
05110	98190	34	2-5/8	1-1/2	12	6
05120	98180	35	2-5/8	1-1/2	12	6
05130	98170	36	2-1/2	1-7/16	12	6
05140	98160	37	2-1/2	1-7/16	12	6
05150	98150	38	2-1/2	1-7/16	12	6
05160	98140	39	2-3/8	1-3/8	12	6
05170	98130	40	2-3/8	1-3/8	12	6
05180	98120	41	2-3/8	1-3/8	12	6
05190	98110	42	2-1/4	1-1/4	12	6
05200	98100	43	2-1/4	1-1/4	12	6
05210	98090	44	2-1/8	1-1/8	12	6
05220	98080	45	2-1/8	1-1/8	12	6
05230	98070	46	2-1/8	1-1/8	12	6
05240	98060	47	2	1	12	6
05250	98050	48	2	1	12	6
05260	98040	49	2	1	12	6
05270	98030	50	2	1	12	6
05280	98020	51	2	1	12	6
05290	98010	52	1-7/8	7/8	12	6

HSS HEAVY-DUTY NAS 907B

Type 240-ACN Carbon Nitride Type 240-ALN Aluminum Nitride

- Heavy-duty construction for drilling in tougher materials
- Manufactured from premium high-speed steel
- 135° split point is self-centering for reducing thrust and easier penetration
- Provides exceptional oxidation resistance and extreme hardness
- TiCN is harder and has a lower coefficient of friction than TiN coating.
- Recommended where moderate temperatures are generated.
- Manufactured to **NAS 907B** aerospace specification



TiCN Coating

Titanium carbon nitride (TiCN) coating raises cutting surface hardness greatly increasing resistance to wear.



TiAlN Coating

Titanium aluminum nitride (TiAlN) designed for use in high temperature operations and difficult to machine material

FRACTIONAL

Type 240- ACN TiCN Coated Part Number	Type 240-ALN TiAlN Coated Part Number	Diameter Inches	Overall Length Inches	Flute Length Inches	Qty. per/Pack
80002	80000	1/16	1-7/8	7/8	6
80012	80010	5/64	2	1	6
80022	80020	3/32	2-1/4	1-1/4	6
80032	80030	7/64	2-5/8	1-1/2	6
80042	80040	1/8	2-3/4	1-5/8	6
80052	80050	9/64	2-7/8	1-3/4	6
80062	80060	5/32	3-1/8	2	6
80072	80070	11/64	3-1/4	2-1/8	6
80082	80080	3/16	3-1/2	2-5/16	6
80092	80090	13/64	3-5/8	2-7/16	6
80102	80100	7/32	3-3/4	2-1/2	6
80112	80110	15/64	3-7/8	2-5/8	6
80122	80120	1/4	4	2-3/4	6
80132	80130	17/64	4-1/8	2-7/8	6
80142	80140	9/32	4-1/4	2-15/16	6
80152	80150	19/64	4-3/8	3-1/16	3
80162	80160	5/16	4-1/2	3-3/16	3
80172	80170	21/64	4-5/8	3-5/16	3
80182	80180	11/32	4-3/4	3-7/16	3
80192	80190	23/64	4-7/8	3-1/2	3
80202	80200	3/8	5	3-5/8	3
80212	80210	25/64	5-1/8	3-3/4	3
80222	80220	13/32	5-1/4	3-7/8	3
80232	80230	27/64	5-3/8	3-15/16	3
80242	80240	7/16	5-1/2	4-1/16	3
80252	80250	29/64	5-5/8	4-3/16	3
80262	80260	15/32	5-3/4	4-5/16	3
80272	80270	31/64	5-7/8	4-3/8	3
80282	80280	1/2	6	4-1/2	3

LETTER

Type 240- ACN TiCN Coated Part Number	Type 240-ALN TiAlN Coated Part Number	Diameter Inches	Overall Length Inches	Flute Length Inches	Qty. per/Pack
80292	80290	A	3-7/8	2-5/8	6
80302	80300	B	4	2-3/4	6
80312	80310	C	4	2-3/4	6
80322	80320	D	4	2-3/4	6
80332	80330	E	4	2-3/4	6
80342	80340	F	4-1/8	2-7/8	6
80352	80350	G	4-1/8	2-7/8	6
80362	80360	H	4-1/8	2-7/8	6
80372	80370	I	4-1/8	2-7/8	6
80382	80380	J	4-1/8	2-7/8	6
80392	80390	K	4-1/4	2-15/16	6
80402	80400	L	4-1/4	2-15/16	6
80412	80410	M	4-3/8	3-1/16	3
80422	80420	N	4-3/8	3-1/16	3
80432	80430	O	4-1/2	3-3/16	3

Letter sizes continued on page 13

Proudly Manufactured in the U.S.A • America's Finest High Speed Steel Cutting Tools™ • Call Toll Free

1.800.328.4655

www.vikingdrill.com

TiCN / TiAlN

Twist Drills - HSS Heavy-Duty NAS 907B

HSS HEAVY-DUTY NAS 907B

Type 240-ACN Carbon Nitride, Type 240-ALN Aluminum Nitride



TiCN Coating

Titanium carbon nitride (TiCN) coating raises cutting surface hardness greatly increasing resistance to wear.



TiAlN Coating

Titanium aluminum nitride (TiAlN) designed for use in high temperature operations and difficult to machine material

- Heavy-duty construction for drilling in tougher materials
 - Manufactured from premium high-speed steel
- 135° split point is self-centering for reducing thrust and easier penetration
- Provides exceptional oxidation resistance and extreme hardness
- TiCN is harder and has a lower coefficient of friction than TiN coating.
 - Recommended where moderate temperatures are generated.
- Manufactured to **NAS 907B** aerospace specification

LETTER

Type 240- ACN TiCN Coated Part Number	Type 240-ALN TiAlN Coated Part Number	Diameter Inches	Overall Length Inches	Flute Length Inches	Qty. per/Pack
80442	80440	P	4-5/8	3-5/16	3
80452	80450	Q	4-3/4	3-7/16	3
80462	80460	R	4-3/4	3-7/16	3
80472	80470	S	4-7/8	3-1/2	3
80482	80480	T	4-7/8	3-1/2	3
80492	80490	U	5	3-5/8	3
80502	80500	V	5	3-5/8	3
80512	80510	W	5-1/8	3-3/4	3
80522	80520	X	5-1/8	3-3/4	3
80532	80530	Y	5-1/4	3-7/8	3
80542	80540	Z	5-1/4	3-7/8	3

WIRE

Type 240- ACN TiCN Coated Part Number	Type 240-ALN TiAlN Coated Part Number	Diameter Inches	Overall Length Inches	Flute Length Inches	Qty. per/Pack
80552	80550	1	3-7/8	2-5/8	6
80562	80560	2	3-7/8	2-5/8	6
80572	80570	3	3-3/4	2-1/2	6
80582	80580	4	3-3/4	2-1/2	6
80592	80590	5	3-3/4	2-1/2	6
80602	80600	6	3-3/4	2-1/2	6
80612	80610	7	3-5/8	2-7/16	6
80622	80620	8	3-5/8	2-7/16	6
80632	80630	9	3-5/8	2-7/16	6
80642	80640	10	3-5/8	2-7/16	6
80652	80650	11	3-1/2	2-5/16	6
80662	80660	12	3-1/2	2-5/16	6
80672	80670	13	3-1/2	2-5/16	6
80682	80680	14	3-3/8	2-3/16	6
80692	80690	15	3-3/8	2-3/16	6
80702	80700	16	3-3/8	2-3/16	6
80712	80710	17	3-3/8	2-3/16	6
80722	80720	18	3-1/4	2-1/8	6
80732	80730	19	3-1/4	2-1/8	6
80742	80740	20	3-1/4	2-1/8	6
80752	80750	21	3-1/4	2-1/8	6
80762	80760	22	3-1/8	2	6
80772	80770	23	3-1/8	2	6
80782	80780	24	3-1/8	2	6
80792	80790	25	3	1-7/8	6
80802	80800	26	3	1-7/8	6
80812	80810	27	3	1-7/8	6
80822	80820	28	2-7/8	1-3/4	6
80832	80830	29	2-7/8	1-3/4	6
80842	80840	30	2-3/4	1-5/8	6
80852	80850	31	2-3/4	1-5/8	6
80862	80860	32	2-3/4	1-5/8	6
80872	80870	33	2-5/8	1-1/2	6
80882	80880	34	2-5/8	1-1/2	6
80892	80890	35	2-5/8	1-1/2	6
80902	80900	36	2-1/2	1-7/16	6

Wire sizes continued on page 14

TiCN / TiAlN

Twist Drills - HSS Heavy-Duty NAS 907 B

HSS HEAVY-DUTY NAS 907B

Type 240-ACN Carbon Nitride Type 240-ALN Aluminum Nitride

- Heavy-duty construction for drilling in tougher materials
- Manufactured from premium high-speed steel
- 135° split point is self-centering for reducing thrust and easier penetration
- Provides exceptional oxidation resistance and extreme hardness
- TiCN is harder and has a lower coefficient of friction than TiN coating.
- Recommended where moderate temperatures are generated.
- Manufactured to **NAS 907B** aerospace specification



TiCN Coating

Titanium carbon nitride (TiCN) coating raises cutting surface hardness greatly increasing resistance to wear.



TiAlN Coating

Titanium aluminum nitride (TiAlN) designed for use in high temperature operations and difficult to machine material

WIRE

Type 240- ACN TiCN Coated Part Number	Type 240-ALN TiAlN Coated Part Number	Diameter Inches	Overall Length Inches	Flute Length Inches	Qty. per/Pack
80912	80910	37	2-1/2	1-7/16	6
80922	80920	38	2-1/2	1-7/16	6
80932	80930	39	2-3/8	1-3/8	6
80942	80940	40	2-3/8	1-3/8	6
80952	80950	41	2-3/8	1-3/8	6
80962	80960	42	2-1/4	1-1/4	6
80972	80970	43	2-1/4	1-1/4	6
80982	80980	44	2-1/8	1-1/8	6
80992	80990	45	2-1/8	1-1/8	6
81002	81000	46	2-1/8	1-1/8	6
81012	81010	47	2	1	6
81022	81020	48	2	1	6
81032	81030	49	2	1	6
81042	81040	50	2	1	6
81052	81050	51	2	1	6
81062	81060	52	1-7/8	7/8	6

TiCN / TiAlN

Twist Drills - HSS Heavy-Duty NAS 907B

GOLDSTRIKE™ & V-LINE HEAVY DUTY

Type 240-GF

Goldstrike™

Premium - 135° Split point

Gold Surface Treated 3-Flats on Shank, 3/16 and Larger

- Heavy-duty 135° split point drills perform well in very demanding applications.
- Ideal for use with hand held drills with key-less chucks.



Type 240-GF

Heavy-duty construction makes it ideal for difficult to drill materials.

Type 248-A

V-Line - Heavy-Duty
Black Oxide 135° Split point

- American made value line drill.
- 135° split point drills are self centering and perform well in harder metals.
- Heavy-duty construction makes this series of drills ideal for the medium to light tensile strength metal drilling applications.



Type 248-A

Designed for the user whose applications are well served without the need for the tighter tolerances of our standard Type 240-A.

FRACTIONAL

Part #	Diameter Inches	Overall Length Inches	Flute Length Inches	Qty. per/pack
40490	1/16	1-7/8	7/8	12
40500	5/64	2	1	12
40510	3/32	2-1/4	1-1/4	12
40520	7/64	2-5/8	1-1/2	12
40530	1/8	2-3/4	1-5/8	12
40540	9/64	2-7/8	1-3/4	12
40550	5/32	3-1/8	2	12
40560	11/64	3-1/4	2-1/8	12
40561	3/16	3-1/2	2-5/16	12
40562	13/64	3-5/8	2-7/16	12
40563	7/32	3-3/4	2-1/2	12
40564	15/64	3-7/8	2-5/8	12
40569	1/4	4	2-3/4	12
40571	17/64	4-1/8	2-7/8	12
40572	9/32	4-1/4	2-15/16	12
40573	19/64	4-3/8	3-1/16	6
40574	5/16	4-1/2	3-3/16	6
40579	21/64	4-5/8	3-5/16	6
40581	11/32	4-3/4	3-7/16	6
40582	23/64	4-7/8	3-1/2	6
40583	3/8	5	3-5/8	6
40584	25/64	5-1/8	3-3/4	6
40589	13/32	5-1/4	3-7/8	6
40591	27/64	5-3/8	3-15/16	6
40592	7/16	5-1/2	4-1/16	6
40593	29/64	5-5/8	4-3/16	6
40594	15/32	5-3/4	4-5/16	6
40601	31/64	5-7/8	4-3/8	6
40602	1/2	6	4-1/2	6

FRACTIONAL

Part #	Diameter Inches	Overall Length Inches	Flute Length Inches	Qty. per/pack
02782	1/16	1-7/8	7/8	12
02792	5/64	2	1	12
02802	3/32	2-1/4	1-1/4	12
02812	7/64	2-5/8	1-1/2	12
02822	1/8	2-3/4	1-5/8	12
02832	9/64	2-7/8	1-3/4	12
02842	5/32	3-1/8	2	12
02852	11/64	3-1/4	2-1/8	12
02862	3/16	3-1/2	2-5/16	12
02872	13/64	3-5/8	2-7/16	12
02882	7/32	3-3/4	2-1/2	12
02892	15/64	3-7/8	2-5/8	12
02902	1/4	4	2-3/4	12
02912	17/64	4-1/8	2-7/8	12
02922	9/32	4-1/4	2-15/16	12
02932	19/64	4-3/8	3-1/16	6
02942	5/16	4-1/2	3-3/16	6
02952	21/64	4-5/8	3-5/16	6
02962	11/32	4-3/4	3-7/16	6
02972	23/64	4-7/8	3-1/2	6
02982	3/8	5	3-5/8	6
02992	25/64	5-1/8	3-3/4	6
03002	13/32	5-1/4	3-7/8	6
03012	27/64	5-3/8	3-15/16	6
03022	7/16	5-1/2	4-1/16	6
03032	29/64	5-5/8	4-3/16	6
03042	15/32	5-3/4	4-5/16	6
03052	31/64	5-7/8	4-3/8	6
03062	1/2	6	4-1/2	6

Type 240-GFR

GOLDSTRIKE™ Reduced Shank -

135° Split Point with 3/8" Reduced Shank with Flats



3/8" WITH FLATS ON SHANK

Part #	Description of Sizes	Per Pack	Part #	Description of Sizes	Per Pack
40633	25/64	6	40622	29/64	6
40634	13/32	6	40623	15/32	6
40639	27/64	6	40624	31/64	6
40621	7/16	6	40629	1/2	6

HSS BLACK OXIDE 118° SPLIT POINT NAS 907A

Type 340-A

- 118° split point is self-centering for reduced thrust and easier penetration
- Black oxide finish for increased wear resistance and added lubricity
- Manufactured to **NAS 907A** aerospace specification



Type 340-A

General-purpose geometry with 118° split point for drilling in a wide range of drilling operations and materials.

FRACTIONAL

Part #	Diameter Inches	Overall Length Inches	Flute Length Inches	Qty. per/pack
35730	1/16	1-7/8	7/8	12
35740	5/64	2	1	12
35750	3/32	2-1/4	1-1/4	12
35760	7/64	2-5/8	1-1/2	12
35770	1/8	2-3/4	1-5/8	12
35780	9/64	2-7/8	1-3/4	12
35790	5/32	3-1/8	2	12
35800	11/64	3-1/4	2-1/8	12
35810	3/16	3-1/2	2-5/16	12
35820	13/64	3-5/8	2-7/16	12
35830	7/32	3-3/4	2-1/2	12
35840	15/64	3-7/8	2-5/8	12
35850	1/4	4	2-3/4	12
35860	17/64	4-1/8	2-7/8	12
35870	9/32	4-1/4	2-15/16	12
35880	19/64	4-3/8	3-1/16	6
35890	5/16	4-1/2	3-3/16	6
35900	21/64	4-5/8	3-5/16	6
35910	11/32	4-3/4	3-7/16	6
35920	23/64	4-7/8	3-1/2	6
35930	3/8	5	3-5/8	6
35940	25/64	5-1/8	3-3/4	6
35950	13/32	5-1/4	3-7/8	6
35960	27/64	5-3/8	3-15/16	6
35970	7/16	5-1/2	4-1/16	6
35980	29/64	5-5/8	4-3/16	6
35990	15/32	5-3/4	4-5/16	6
36000	31/64	5-7/8	4-3/8	6
36010	1/2	6	4-1/2	6

LETTER

Part #	Letter Sizes	Overall Length Inches	Flute Length Inches	Qty. per/pack
82750	A	3-7/8	2-5/8	12
82760	B	4	2-3/4	12
82770	C	4	2-3/4	12
82780	D	4	2-3/4	12
82790	E	4	2-3/4	12
82800	F	4-1/8	2-7/8	12
82810	G	4-1/8	2-7/8	12
82820	H	4-1/8	2-7/8	12
82830	I	4-1/8	2-7/8	12
82840	J	4-1/8	2-7/8	12
82850	K	4-1/4	2-15/16	12
82860	L	4-1/4	2-15/16	12
82870	M	4-3/8	3-1/16	6
82880	N	4-3/8	3-1/16	6
82890	O	4-1/2	3-3/16	6
82900	P	4-5/8	3-5/16	6
82910	Q	4-3/4	3-7/16	6
82920	R	4-3/4	3-7/16	6
82930	S	4-7/8	3-1/2	6
82940	T	4-7/8	3-1/2	6
82950	U	5	3-5/8	6
82960	V	5	3-5/8	6
82970	W	5-1/8	3-3/4	6
82980	X	5-1/8	3-3/4	6
82990	Y	5-1/4	3-7/8	6
83000	Z	5-1/4	3-7/8	6

WIRE

Part #	Wire Sizes	Overall Length Inches	Flute Length Inches	Qty. per/pack
66710	1	3-7/8	2-5/8	12
57280	2	3-7/8	2-5/8	12
66700	3	3-3/4	2-1/2	12
57370	4	3-3/4	2-1/2	12
95430	5	3-3/4	2-1/2	12
66690	6	3-3/4	2-1/2	12
66680	7	3-5/8	2-7/16	12
66770	8	3-5/8	2-7/16	12
66760	9	3-5/8	2-7/16	12
92630	10	3-5/8	2-7/16	12
66670	11	3-1/2	2-5/16	12
66220	12	3-1/2	2-5/16	12
92640	13	3-1/2	2-5/16	12
66660	14	3-3/8	2-3/16	12
66650	15	3-3/8	2-3/16	12
66640	16	3-3/8	2-3/16	12
57290	17	3-3/8	2-3/16	12
66810	18	3-1/4	2-1/8	12
57550	19	3-1/4	2-1/8	12
66630	20	3-1/4	2-1/8	12
66620	21	3-1/4	2-1/8	12

Part #	Overall Wire Sizes	Flute Length Inches	Length Inches	Qty. per/pack
57630	22	3-1/8	2	12
66610	23	3-1/8	2	12
66720	24	3-1/8	2	12
57360	25	3	1-7/8	12
66600	26	3	1-7/8	12
66750	27	3	1-7/8	12
57700	28	2-7/8	1-3/4	12
66590	29	2-7/8	1-3/4	12
95420	30	2-3/4	1-5/8	12
66800	31	2-3/4	1-5/8	12
66350	32	2-3/4	1-5/8	12
66580	33	2-5/8	1-1/2	12
66740	34	2-5/8	1-1/2	12
57350	35	2-5/8	1-1/2	12
66570	36	2-1/2	1-7/16	12
66560	37	2-1/2	1-7/16	12
66550	38	2-1/2	1-7/16	12
57560	39	2-3/8	1-3/8	12
66540	40	2-3/8	1-3/8	12

Twist Drills - HSS Black Oxide 118° NAS 907A

GENERAL PURPOSE & TITANIUM NITRIDE

Type 240, Type 240-B, Type 240-BN Titanium Nitride

118° Point



Type 240

Black Oxide surface finish increases wear resistance and adds lubricity to improve chip flow.



Type 240-B

Recommended for non-ferrous metals, wood and plastic.



Type 240-BN

Performs well in mild drilling applications with abrasive wear characteristics.

- Widely used in general purpose applications
- Designed for a wide range of operating conditions and materials

FRACTIONAL

Black Oxide Type 240 Part Number	Bright Type 240-B Part Number	Titanium Nitride Type 240-BN Part Number	Diameter Inches	Overall Length Inches	Flute Length Inches	Black Oxide / Bright Type 240 / Type 240-B Qty. per/Pack	Titanium Nitride Type 240-BN Qty. per/Pack
01000	02750	97920	1/64	3/4	3/16	12	6
01010	02760	97910	1/32	1-3/8	1/2	12	6
01020	02770	97900	3/64	1-3/4	3/4	12	6
01030	02780	22570	1/16	1-7/8	7/8	12	6
01040	02790	22580	5/64	2	1	12	6
01050	02800	22590	3/32	2-1/4	1-1/4	12	6
01060	02810	22600	7/64	2-5/8	1-1/2	12	6
01070	02820	22610	1/8	2-3/4	1-5/8	12	6
01080	02830	22620	9/64	2-7/8	1-3/4	12	6
01090	02840	22630	5/32	3-1/8	2	12	6
01100	02850	22640	11/64	3-1/4	2-1/8	12	6
01110	02860	22650	3/16	3-1/2	2-5/16	12	6
05930	16870	22660	13/64	3-5/8	2-7/16	12	6
05940	16880	22670	7/32	3-3/4	2-1/2	12	6
05950	16890	22680	15/64	3-7/8	2-5/8	12	6
05960	16900	22690	1/4	4	2-3/4	12	6
05970	16910	22700	17/64	4-1/8	2-7/8	12	6
05980	16920	22710	9/32	4-1/4	2-15/16	12	6
05990	16930	22720	19/64	4-3/8	3-1/16	6	3
06000	16940	22730	5/16	4-1/2	3-3/16	6	3
06010	16950	22740	21/64	4-5/8	3-5/16	6	3
06020	16960	22750	11/32	4-3/4	3-7/16	6	3
06030	16970	22760	23/64	4-7/8	3-1/2	6	3
06040	16980	22770	3/8	5	3-5/8	6	3
06050	16990	22780	25/64	5-1/8	3-3/4	6	3
06060	17000	22790	13/32	5-1/4	3-7/8	6	3
06070	17010	22800	27/64	5-3/8	3-15/16	6	3
06080	17020	22810	7/16	5-1/2	4-1/16	6	3
06090	17030	22820	29/64	5-5/8	4-3/16	6	3
06100	17040	22830	15/32	5-3/4	4-5/16	6	3
06110	17050	22840	31/64	5-7/8	4-3/8	6	3
06120	17060	22850	1/2	6	4-1/2	6	3
01320	48370	32500	33/64	6-5/8	4-13/16	1	1
01330	48380	32510	17/32	6-5/8	4-13/16	1	1
01340	48390	32520	35/64	6-5/8	4-13/16	1	1
01350	48400	32530	9/16	6-5/8	4-13/16	1	1
01360	48410	32540	37/64	6-5/8	4-13/16	1	1
01370	48420	32550	19/32	7-1/8	5-3/16	1	1
01380	48430	32560	39/64	7-1/8	5-3/16	1	1
01390	48440	32570	5/8	7-1/8	5-3/16	1	1
01400	48450	32580	41/64	7-1/8	5-3/16	1	1
01410	48460	32590	21/32	7-1/8	5-3/16	1	1
01420	48470	32600	43/64	7-5/8	5-5/8	1	1
01430	48480	32610	11/16	7-5/8	5-5/8	1	1
12370	48730	32650	3/4	7-5/8	5-5/8	1	1

TiN

Twist Drills - General Purpose & TiN Coated

GENERAL PURPOSE & TITANIUM NITRIDE

Type 240, Type 240-B, Type 240-BN Titanium Nitride

118° Point

- Widely used in general purpose applications
- Designed for a wide range of operating conditions and materials



Type 240

Black Oxide surface finish increases wear resistance and adds lubricity to improve chip flow.



Type 240-B

It is recommended for non-ferrous metals, wood and plastic.



Type 240-BN

Performs well in mild drilling applications with abrasive wear characteristics.

TiN
Twist Drills - General Purpose & TiN Coated

LETTER

Black Oxide Type 240 Part Number	Bright Type 240-B Part Number	Titanium Nitride Type 240-BN Part Number	Letter Sizes	Overall Length Inches	Flute Length Inches	Black Oxide / Bright Type 240 / Type 240-B Qty. per/Pack	Titanium Nitride Type 240-BN Qty. per/Pack
02410	04160	22890	A	3-7/8	2-5/8	12	6
02420	04170	22900	B	4	2-3/4	12	6
02430	04180	22910	C	4	2-3/4	12	6
02440	04190	22920	D	4	2-3/4	12	6
02450	04200	22930	E	4	2-3/4	12	6
02460	04210	22940	F	4-1/8	2-7/8	12	6
02470	04220	22950	G	4-1/8	2-7/8	12	6
02480	04230	22960	H	4-1/8	2-7/8	12	6
02490	04240	22970	I	4-1/8	2-7/8	12	6
02500	04250	22980	J	4-1/8	2-7/8	12	6
02510	04260	22990	K	4-1/4	2-15/16	12	6
02520	04270	23000	L	4-1/4	2-15/16	12	6
02530	04280	23010	M	4-3/8	3-1/16	6	3
02540	04290	23020	N	4-3/8	3-1/16	6	3
02550	04300	23030	O	4-1/2	3-3/16	6	3
02560	04310	23040	P	4-5/8	3-5/16	6	3
02570	04320	23050	Q	4-3/4	3-7/16	6	3
02580	04330	23060	R	4-3/4	3-7/16	6	3
02590	04340	23070	S	4-7/8	3-1/2	6	3
02600	04350	23080	T	4-7/8	3-1/2	6	3
02610	04360	22790	U	5	3-5/8	6	3
02620	04370	23100	V	5	3-5/8	6	3
02630	04380	23110	W	5-1/8	3-3/4	6	3
02640	04390	23120	X	5-1/8	3-3/4	6	3
02650	04400	23130	Y	5-1/4	3-7/8	6	3
02660	04410	23140	Z	5-1/4	3-7/8	6	3

WIRE

Black Oxide Type 240 Part Number	Bright Type 240-B Part Number	Titanium Nitride Type 240-BN Part Number	Wire Sizes	Overall Length Inches	Flute Length Inches	Black Oxide / Bright Type 240 / Type 240-B Qty. per/Pack	Titanium Nitride Type 240-BN Qty. per/Pack
01440	03190	47790	1	3-7/8	2-5/8	12	6
01450	03200	47800	2	3-7/8	2-5/8	12	6
01460	03210	47810	3	3-3/4	2-1/2	12	6
01470	03220	47820	4	3-3/4	2-1/2	12	6
01480	03230	47830	5	3-3/4	2-1/2	12	6
01490	03240	47840	6	3-3/4	2-1/2	12	6
01500	03250	47850	7	3-5/8	2-7/16	12	6

Wire sizes continued on page 19

GENERAL PURPOSE & TITANIUM NITRIDE

Type 240, Type 240-B, Type 240-BN Titanium Nitride

118° Point



Type 240

Black Oxide surface finish increases wear resistance and adds lubricity to improve chip flow.



Type 240-B

It is recommended for non-ferrous metals, wood and plastic.



Type 240-BN

Performs well in mild drilling applications with abrasive wear characteristics.

- Widely used in general purpose applications
- Designed for a wide range of operating conditions and materials

WIRE

Black Oxide Type 240 Part Number	Bright Type 240-B Part Number	Titanium Nitride Type 240-BN Part Number	Wire Sizes	Overall Length Inches	Flute Length Inches	Black Oxide / Bright Type 240 / Type 240-B Qty. per/Pack	Titanium Nitride Type 240-BN Qty. per/Pack
01510	03260	47860	8	3-5/8	2-7/16	12	6
01520	03270	47870	9	3-5/8	2-7/16	12	6
01530	03280	47880	10	3-5/8	2-7/16	12	6
01540	03290	47890	11	3-1/2	2-5/16	12	6
01550	03300	47900	12	3-1/2	2-5/16	12	6
01560	03310	47910	13	3-1/2	2-5/16	12	6
01570	03320	47920	14	3-3/8	2-3/16	12	6
01580	03330	47930	15	3-3/8	2-3/16	12	6
01590	03340	47940	16	3-3/8	2-3/16	12	6
01600	03350	47950	17	3-3/8	2-3/16	12	6
01610	03360	47960	18	3-1/4	2-1/8	12	6
01620	03370	47970	19	3-1/4	2-1/8	12	6
01630	03380	47980	20	3-1/4	2-1/8	12	6
01640	03390	47990	21	3-1/4	2-1/8	12	6
01650	03400	48000	22	3-1/8	2	12	6
01660	03410	48010	23	3-1/8	2	12	6
01670	03420	48020	24	3-1/8	2	12	6
01680	03430	48030	25	3	1-7/8	12	6
01690	03440	48040	26	3	1-7/8	12	6
01700	03450	48050	27	3	1-7/8	12	6
01710	03460	48060	28	2-7/8	1-3/4	12	6
01720	03470	48070	29	2-7/8	1-3/4	12	6
01730	03480	48080	30	2-3/4	1-5/8	12	6
01740	03490	48090	31	2-3/4	1-5/8	12	6
01750	03500	48100	32	2-3/4	1-5/8	12	6
01760	03510	48110	33	2-5/8	1-1/2	12	6
01770	03520	48120	34	2-5/8	1-1/2	12	6
01780	03530	48130	35	2-5/8	1-1/2	12	6
01790	03540	48140	36	2-1/2	1-7/16	12	6
01800	03550	48150	37	2-1/2	1-7/16	12	6
01810	03560	48160	38	2-1/2	1-7/16	12	6
01820	03570	48170	39	2-3/8	1-3/8	12	6
01830	03580	48180	40	2-3/8	1-3/8	12	6
01840	03590	48190	41	2-3/8	1-3/8	12	6
01850	03600	48200	42	2-1/4	1-1/4	12	6
01860	03610	48210	43	2-1/4	1-1/4	12	6
01870	03620	48220	44	2-1/8	1-1/8	12	6
01880	03630	48230	45	2-1/8	1-1/8	12	6
01890	03640	48240	46	2-1/8	1-1/8	12	6
01900	03650	48250	47	2	1	12	6
01910	03660	48260	48	2	1	12	6
01920	03670	48270	49	2	1	12	6
01930	03680	48280	50	2	1	12	6
01940	03690	48290	51	2	1	12	6

Wire sizes continued on page 20

TiN

Twist Drills - General Purpose & TiN Coated

GENERAL PURPOSE & TITANIUM NITRIDE

Type 240, Type 240-B, Type 240-BN Titanium Nitride

118° Point

- Widely used in general purpose applications
- Designed for a wide range of operating conditions and materials



Type 240

Black Oxide surface finish increases wear resistance and adds lubricity to improve chip flow.



Type 240-B

It is recommended for non-ferrous metals, wood and plastic.



Type 240-BN

Performs well in mild drilling applications with abrasive wear characteristics.

WIRE

Black Oxide Type 240 Part Number	Bright Type 240-B Part Number	Titanium Nitride Type 240-BN Part Number	Wire Sizes	Overall Length Inches	Flute Length Inches	Black Oxide / Bright Type 240 / Type 240-B Qty. per/Pack	Titanium Nitride Type 240-BN Qty. per/Pack
01950	03700	48300	52	1-7/8	7/8	12	6
01960	03710	98000	53	1-7/8	7/8	12	6
01970	03720	97990	54	1-7/8	7/8	12	6
01980	03730	97980	55	1-7/8	7/8	12	6
01990	03740	97970	56	1-3/4	3/4	12	6
02000	03750	97960	57	1-3/4	3/4	12	6
02010	03760	97950	58	1-5/8	11/16	12	6
02020	03770	97940	59	1-5/8	11/16	12	6
02030	03780	97930	60	1-5/8	11/16	12	6
02040	03790	----	61	1-5/8	11/16	12	----
02050	03800	----	62	1-1/2	5/8	12	----
02060	03810	----	63	1-1/2	5/8	12	----
02070	03820	----	64	1-1/2	5/8	12	----
02080	03830	----	65	1-1/2	5/8	12	----
02090	03840	----	66	1-3/8	1/2	12	----
02100	03850	----	67	1-3/8	1/2	12	----
02110	03860	----	68	1-3/8	1/2	12	----
02120	03870	----	69	1-3/8	1/2	12	----
02130	03880	----	70	1-1/4	3/8	12	----
02140	03890	----	71	1-1/4	3/8	12	----
02150	03900	----	72	1-1/8	5/16	12	----
02160	03910	----	73	1-1/8	5/16	12	----
02170	03920	----	74	1	1/4	12	----
02180	03930	----	75	1	1/4	12	----
02190	03940	----	76	7/8	3/16	12	----
02200	03950	----	77	7/8	3/16	12	----
02210	03960	----	78	7/8	3/16	12	----
02220	03970	----	79	3/4	1/8	12	----
02230	03980	----	80	3/4	1/8	12	----
----	03990	----	81	3/4	1/8	12	----
----	04000	----	82	3/4	1/8	12	----
----	04010	----	83	3/4	1/8	12	----
----	04020	----	84	3/4	3/32	12	----
----	04030	----	85	3/4	3/32	12	----

Wire sizes continued on page 21

GENERAL PURPOSE & TITANIUM NITRIDE

Type 240, Type 240-B, Type 240-BN Titanium Nitride 118° Point



Type 240

Black Oxide surface finish increases wear resistance and adds lubricity to improve chip flow.



Type 240-B

It is recommended for non-ferrous metals, wood and plastic.



Type 240-BN

Performs well in mild drilling applications with strong abrasive wear characteristics.

- Widely used in general purpose applications.
- Designed for a wide range of operating conditions and materials.

WIRE

Black Oxide Type 240 Part Number	Bright Type 240-B Part Number	Titanium Nitride Type 240-BN Part Number	Wire Sizes	Overall Length Inches	Flute Length Inches	Black Oxide / Bright Type 240 / Type 240-B Qty. per/Pack	Titanium Nitride Type 240-BN Qty. per/Pack
----	04040	----	86	3/4	3/32	12	----
----	04050	----	87	3/4	3/32	12	----
----	04060	----	88	3/4	5/64	12	----
----	04070	----	89	3/4	5/64	12	----
----	04080	----	90	3/4	5/64	12	----
----	04090	----	91	3/4	5/64	12	----
----	04100	----	92	3/4	1/16	12	----
----	04110	----	93	3/4	1/16	12	----
----	04120	----	94	3/4	1/16	12	----
----	04130	----	95	3/4	1/16	12	----
----	04140	----	96	3/4	1/16	12	----
----	04150	----	97	3/4	1/16	12	----

Type 248

V-line - General Purpose Black Oxide, 118° point

- American made value line drill
- These general purpose 118° point HSS drills are ideal for a wide variety of light tensile strength metal drilling applications.



- This series is designed for the user whose applications are well served without the need for the tighter tolerances of our standard Type 240.

FRACTIONAL

Part #	Diameter Inches	Overall Length Inches	Flute Length Inches	Qty. per/pack	Part #	Diameter Inches	Overall Length Inches	Flute Length Inches	Qty. per/pack
02783	1/16	1-7/8	7/8	12	02923	9/32	4-1/4	2-15/16	12
02793	5/64	2	1	12	02933	19/64	4-3/8	3-1/16	6
02803	3/32	2-1/4	1-1/4	12	02943	5/16	4-1/2	3-3/16	6
02813	7/64	2-5/8	1-1/2	12	02953	21/64	4-5/8	3-5/16	6
02823	1/8	2-3/4	1-5/8	12	02963	11/32	4-3/4	3-7/16	6
02833	9/64	2-7/8	1-3/4	12	02973	23/64	4-7/8	3-1/2	6
02843	5/32	3-1/8	2	12	02983	3/8	5	3-5/8	6
02853	11/64	3-1/4	2-1/8	12	02993	25/64	5-1/8	3-3/4	6
02863	3/16	3-1/2	2-5/16	12	03003	13/32	5-1/4	3-7/8	6
02873	13/64	3-5/8	2-7/16	12	03013	27/64	5-3/8	3-15/16	6
02883	7/32	3-3/4	2-1/2	12	03023	7/16	5-1/2	4-1/16	6
02893	15/64	3-7/8	2-5/8	12	03033	29/64	5-5/8	4-3/16	6
02903	1/4	4	2-3/4	12	03043	15/32	5-3/4	4-5/16	6
02913	17/64	4-1/8	2-7/8	12	03053	31/64	5-7/8	4-3/8	6
					03063	1/2	6	4-1/2	6

GENERAL PURPOSE - BLACK OXIDE AND BRIGHT FINISH

Type 643 - METRIC

118° Point General Purpose - Black Oxide

- Widely used in general purpose applications
- Designed for a wide range of operating conditions and materials

Type 643-W METRIC

118° Point General Purpose - Bright Finish

- This 118° point, high-speed steel drill performs well in a wide variety of drilling applications.
- It is recommended for non-ferrous metals, wood and plastics.



METRIC

Type 643 Part #	Type 643-W Part #	Dia. MM	Overall Length MM	Overall Length Inches	Flute Length MM	Flute Length Inches	Qty. per/pack
20630	17160	.75	35	1-3/8	13	1/2	10
20640	17070	.80	35	1-3/8	13	1/2	10
20650	17080	.85	38	1-1/2	16	5/8	10
20660	29020	.90	38	1-1/2	16	5/8	10
20670	29030	.95	38	1-1/2	16	5/8	10
20680	29040	1.00	41	1-5/8	17	11/16	10
20690	29050	1.05	41	1-5/8	17	11/16	10
20700	29060	1.10	44	1-3/4	19	3/4	10
20710	17100	1.15	44	1-3/4	19	3/4	10
20720	29070	1.20	48	1-7/8	22	7/8	10
20730	17150	1.25	48	1-7/8	22	7/8	10
20740	29080	1.30	48	1-7/8	22	7/8	10
20750	29090	1.35	48	1-7/8	22	7/8	10
20760	29100	1.40	48	1-7/8	22	7/8	10
20780	17110	1.50	48	1-7/8	22	7/8	10
20800	29110	1.60	48	1-7/8	22	7/8	10
20820	29010	1.70	51	2	25	1	10
20830	17120	1.75	51	2	25	1	10
20840	17130	1.80	51	2	25	1	10
20860	29120	1.90	51	2	25	1	10
20880	20881	2.00	51	2	25	1	10
20980	20981	2.50	60	2-23/64	35	1-3/8	10
21040	21041	3.00	70	2-3/4	41	1-5/8	10
21110	21111	3.50	73	2-7/8	45	1-3/4	10
21170	21171	4.00	83	3-1/4	54	2-1/8	10
21230	21231	4.50	86	3-3/8	56	2-13/64	10
21290	21291	5.00	92	3-5/8	62	2-7/16	10
21350	21351	5.50	95	3-3/4	64	2-1/2	10
21410	21411	6.00	102	4	70	2-3/4	10
21470	21471	6.50	105	4-1/8	73	2-7/8	10
21530	21531	7.00	105	4-1/8	73	2-7/8	10
21590	21591	7.50	111	4-3/8	78	3	5
21650	21651	8.00	114	4-1/2	81	3-3/16	5
21710	21711	8.50	121	4-3/4	87	3-27/64	5
21770	21771	9.00	124	4-7/8	89	3-1/2	5
21830	21831	9.50	127	5	92	3-5/8	5
21890	21891	10.00	130	5-1/8	95	3-3/4	5
21900	21901	10.50	133	5-15/64	98	3-7/8	5
21910	21911	11.00	140	5-1/2	103	4-1/16	5
21920	21921	11.50	143	5-5/8	106	4-7/32	5
21930	21931	12.00	149	5-7/8	111	4-3/8	5
21940	21941	12.50	152	6	114	4-1/2	5
21950	21951	13.00	152	6	114	4-1/2	5

METRIC

Twist Drills - General Purpose Black Oxide & Bright Finish

Jobber Length

1/4" & 3/8" REDUCED SHANK

Type 275

General Purpose 118° point - Bright Finish
1/4" Reduced Shank - Shorter than Jobber Length

- Shorter than ϕ bber length increases rigidity and improves drilling performance.
- Designed for use in portable air and electric drilling equipment with 1/4" chucks.



FRACTIONAL

Part #	Diameter Inches	Overall Length Inches	Flute Length Inches	Qty. per/pack
28800	17/64	3-1/2	1-7/8	12
28810	9/32	3-19/32	1-31/32	12
28820	19/64	3-23/32	2-1/16	6
28830	5/16	3-27/32	2-3/16	6
28840	21/64	4	2-9/32	6
28850	11/32	4-1/32	2-11/32	6
28860	23/64	4-5/32	2-15/32	6
28870	3/8	4-1/4	2-9/16	6
28880	25/64	4-11/32	2-5/8	6
28890	13/32	4-15/32	2-3/4	6
28900	27/64	4-9/16	2-27/32	6
28910	7/16	4-11/16	2-15/16	6
28920	29/64	4-25/32	3-1/32	6
28930	15/32	4-7/8	3-1/8	6
28940	31/64	5	3-7/32	6
28950	1/2	5	3-7/32	6

These items are also available carded.
See Price List Catalog for details.

Type 278

General Purpose 118° point - Bright Finish
3/8" Reduced Shank - Jobber Length

- General purpose 118° point HSS drill is designed for use in portable air or electric drilling equipment with 3/8" chucks.

NOTE: Surface treated flutes on sizes larger than 1/2"



FRACTIONAL

Part #	Diameter Inches	Overall Length Inches	Flute Length Inches	Qty. per/pack
59570	25/64	5-1/8	3-3/4	6
59580	13/32	5-1/4	3-7/8	6
59590	27/64	5-3/8	3-15/16	6
59500	7/16	5-1/2	4-1/16	6
59600	29/64	5-5/8	4-3/16	6
59510	15/32	5-3/4	4-5/16	6
59610	31/64	5-7/8	4-3/8	6
59520	1/2	6	4-1/2	6
59530	17/32	6	4-1/4	1
59540	9/16	6	4-1/4	1
59550	19/32	6	4-1/4	1
59560	5/8	6	4-1/4	1

These items are also available carded.
See Price List Catalog for details.

Twist Drills - General Purpose 1/4" & 3/8" Reduced Shank

FAST SPIRAL HIGH HELIX

Type 240-F

Fast Spiral High Helix - 118° Point Bright Finish



• HSS drill performs well in deep hole drilling of low tensile strength material such as aluminum, zinc, copper, wood, refrigeration die castings, auto hardware & epoxy based plastics.

• Use to drill free machining steels, brass & bronze.

FRACTIONAL

Part #	Diameter Inches	Overall Length Inches	Flute Length Inches	Qty. per/pack
06550	1/32	1-3/8	1/2	12
06560	3/64	1-3/4	3/4	12
06570	1/16	1-7/8	7/8	12
06580	5/64	2	1	12
06590	3/32	2-1/4	1-1/4	12
06600	7/64	2-5/8	1-1/2	12
06610	1/8	2-3/4	1-5/8	12
06620	9/64	2-7/8	1-3/4	12
06630	5/32	3-1/8	2	12
06640	11/64	3-1/4	2-1/8	12
06650	3/16	3-1/2	2-5/16	12
06660	13/64	3-5/8	2-7/16	12
06670	7/32	3-3/4	2-1/2	12
06680	15/64	3-7/8	2-5/8	12
06690	1/4	4	2-3/4	12
06700	17/64	4-1/8	2-7/8	12
06710	9/32	4-1/4	2-15/16	12
06720	19/64	4-3/8	3-1/16	6
06730	5/16	4-1/2	3-3/16	6
06740	21/64	4-5/8	3-5/16	6
06750	11/32	4-3/4	3-7/16	6
06760	23/64	4-7/8	3-1/2	6
06770	3/8	5	3-5/8	6
06780	25/64	5-1/8	3-3/4	6
06790	13/32	5-1/4	3-7/8	6
06800	27/64	5-3/8	3-15/16	6
06810	7/16	5-1/2	4-1/16	6
06820	29/64	5-5/8	4-3/16	6
06830	15/32	5-3/4	4-5/16	6
06840	31/64	5-7/8	4-3/8	6
06850	1/2	6	4-1/2	6

LETTER

Part #	Letter Sizes	Overall Length Inches	Flute Length Inches	Qty. per/pack
07660	A	3-7/8	2-5/8	12
07670	B	4	2-3/4	12
07680	C	4	2-3/4	12
07690	D	4	2-3/4	12
07700	E	4	2-3/4	12
07710	F	4-1/8	2-7/8	12
07720	G	4-1/8	2-7/8	12
07730	H	4-1/8	2-7/8	12
07740	I	4-1/8	2-7/8	12
07750	J	4-1/8	2-7/8	12
07760	K	4-1/4	2-15/16	12
07770	L	4-1/4	2-15/16	12
07780	M	4-3/8	3-1/16	6
07790	N	4-3/8	3-1/16	6
07800	O	4-1/2	3-3/16	6
07810	P	4-5/8	3-5/16	6
07820	Q	4-3/4	3-7/16	6
07830	R	4-3/4	3-7/16	6
07840	S	4-7/8	3-1/2	6
07850	T	4-7/8	3-1/2	6
07860	U	5	3-5/8	6
07870	V	5	3-5/8	6
07880	W	5-1/8	3-3/4	6
07890	X	5-1/8	3-3/4	6
07900	Y	5-1/4	3-7/8	6
07910	Z	5-1/4	3-7/8	6

WIRE

Part #	Wire Sizes	Overall Length Inches	Flute Length Inches	Qty. per/pack
06860	1	3-7/8	2-5/8	12
06870	2	3-7/8	2-5/8	12
06880	3	3-3/4	2-1/2	12
06890	4	3-3/4	2-1/2	12
06900	5	3-3/4	2-1/2	12
06910	6	3-3/4	2-1/2	12
06920	7	3-5/8	2-7/16	12
06930	8	3-5/8	2-7/16	12
06940	9	3-5/8	2-7/16	12
06950	10	3-5/8	2-7/16	12
06960	11	3-1/2	2-5/16	12
06970	12	3-1/2	2-5/16	12
06980	13	3-1/2	2-5/16	12
06990	14	3-3/8	2-3/16	12
07000	15	3-3/8	2-3/16	12
07010	16	3-3/8	2-3/16	12
07020	17	3-3/8	2-3/16	12
07030	18	3-1/4	2-1/8	12
07040	19	3-1/4	2-1/8	12
07050	20	3-1/4	2-1/8	12
07060	21	3-1/4	2-1/8	12
07070	22	3-1/8	2	12
07080	23	3-1/8	2	12
07090	24	3-1/8	2	12
07100	25	3	1-7/8	12
07110	26	3	1-7/8	12
07120	27	3	1-7/8	12
07130	28	2-7/8	1-3/4	12
07140	29	2-7/8	1-3/4	12
07150	30	2-3/4	1-5/8	12
07160	31	2-3/4	1-5/8	12
07170	32	2-3/4	1-5/8	12
07180	33	2-5/8	1-1/2	12
07190	34	2-5/8	1-1/2	12
07200	35	2-5/8	1-1/2	12
07210	36	2-1/2	1-7/16	12
07220	37	2-1/2	1-7/16	12
07230	38	2-1/2	1-7/16	12
07240	39	2-3/8	1-3/8	12
07250	40	2-3/8	1-3/8	12
07260	41	2-3/8	1-3/8	12
07270	42	2-1/4	1-1/4	12
07280	43	2-1/4	1-1/4	12
07290	44	2-1/8	1-1/8	12
07300	45	2-1/8	1-1/8	12
07310	46	2-1/8	1-1/8	12
07320	47	2	1	12
07330	48	2	1	12
07340	49	2	1	12
07350	50	2	1	12
07360	51	2	1	12
07370	52	1-7/8	7/8	12
07380	53	1-7/8	7/8	12
07390	54	1-7/8	7/8	12
07400	55	1-7/8	7/8	12
07410	56	1-3/4	3/4	12
07420	57	1-3/4	3/4	12
07430	58	1-5/8	5/8	12
07440	59	1-5/8	5/8	12
07450	60	1-5/8	5/8	12

HEAVY-DUTY & TITANIUM NITRIDE PARABOLIC FLUTE

Type 240-P

135° Split Point - Black Oxide

- Parabolic flute drills are designed to allow deep hole drilling without frequent drill removal to clear chips.
- Parabolic flute drills perform best in low to medium tensile strength materials.



Type 240-PT Titanium Nitride

135° Split Point

- Parabolic flute drills are designed to allow deep hole drilling without frequent drill removal to clear chips.
- Exceptional high performance drill with the super hard TiN coating extends tool life 500% or more in very abrasive drilling applications.



Type 240-P Black Oxide		FRACTIONAL			Type 240-P Black Oxide	
Part Number	Type 240-PT TiN Coated Part Number	Diameter Inches	Overall Length Inches	Flute Length Inches	Qty. per/Pack	Type 240-PT TiN Coated Qty. per/Pack
36800	37870	1/16	1-7/8	7/8	12	6
36810	37880	5/64	2	1	12	6
36820	37890	3/32	2-1/4	1-1/4	12	6
36830	37900	7/64	2-5/8	1-1/2	12	6
36840	37910	1/8	2-3/4	1-5/8	12	6
36850	37920	9/64	2-7/8	1-3/4	12	6
36860	37930	5/32	3-1/8	2	12	6
36870	37940	11/64	3-1/4	2-1/8	12	6
36880	37950	3/16	3-1/2	2-5/16	12	6
36890	37960	13/64	3-5/8	2-7/16	12	6
36900	37970	7/32	3-3/4	2-1/2	12	6
36910	37980	15/64	3-7/8	2-5/8	12	6
36920	37990	1/4	4	2-3/4	12	6
36930	38000	17/64	4-1/8	2-7/8	12	6
36940	38010	9/32	4-1/4	2-15/16	12	6
36950	38020	19/64	4-3/8	3-1/16	6	3
36960	38030	5/16	4-1/2	3-3/16	6	3
36970	38040	21/64	4-5/8	3-5/16	6	3
36980	38050	11/32	4-3/4	3-7/16	6	3
36990	38060	23/64	4-7/8	3-1/2	6	3
37000	38070	3/8	5	3-5/8	6	3
37010	38080	25/64	5-1/8	3-3/4	6	3
37020	38090	13/32	5-1/4	3-7/8	6	3
37030	38100	27/64	5-3/8	3-15/16	6	3
37040	38110	7/16	5-1/2	4-1/16	6	3
37050	38120	29/64	5-5/8	4-3/16	6	3
37060	38130	15/32	5-3/4	4-5/16	6	3
37070	38140	31/64	5-7/8	4-3/8	6	3
37080	38150	1/2	6	4-1/2	6	3

Type 240-P Black Oxide		WIRE			Type 240-P Black Oxide	
Part Number	Type 240-PT TiN Coated Part Number	Wire Sizes	Overall Length Inches	Flute Length Inches	Qty. per/Pack	Type 240-PT TiN Coated Qty. per/Pack
68161	68162	1	3-7/8	2-5/8	12	6
68171	68172	2	3-7/8	2-5/8	12	6
38171	38172	3	3-3/4	2-1/2	12	6
68181	68182	4	3-3/4	2-1/2	12	6
68191	68192	5	3-3/4	2-1/2	12	6
68201	68202	6	3-3/4	2-1/2	12	6
58421	58422	7	3-5/8	2-7/16	12	6
68211	68212	8	3-5/8	2-7/16	12	6
68221	68222	9	3-5/8	2-7/16	12	6
68231	68232	10	3-5/8	2-7/16	12	6
68241	68242	11	3-1/2	2-5/16	12	6
68251	68252	12	3-1/2	2-5/16	12	6
68261	68262	13	3-1/2	2-5/16	12	6
68271	68272	14	3-3/8	2-3/16	12	6
68281	68282	15	3-3/8	2-3/16	12	6
68291	68292	16	3-3/8	2-3/16	12	6

Wire sizes continued on page 26

TiN

Twist Drills - Heavy-Duty & TiN Coated Parabolic Flute

HEAVY-DUTY & TITANIUM NITRIDE PARABOLIC FLUTE

Type 240-P

135° Split Point - Black Oxide



Type 240-PT Titanium Nitride

135° Split Point - TiN Coated



TiN

Twist Drills - Parabolic & TiN Coated Parabolic Flutes

Type 240-P Black Oxide		WIRE			Type 240-P Black Oxide	
Part Number	Part Number	Wire Sizes	Overall Length Inches	Flute Length Inches	Qty. per/Pack	Qty. per/Pack
68301	68302	17	3-3/8	2-3/16	12	6
58591	58592	18	3-1/4	2-1/8	12	6
68311	68312	19	3-1/4	2-1/8	12	6
58381	58382	20	3-1/4	2-1/8	12	6
58721	58722	21	3-1/4	2-1/8	12	6
68321	68322	22	3-1/8	2	12	6
68331	68332	23	3-1/8	2	12	6
68341	68342	24	3-1/8	2	12	6
58901	58902	25	3	1-7/8	12	6
68351	68352	26	3	1-7/8	12	6
68361	68362	27	3	1-7/8	12	6
68371	68372	28	2-7/8	1-3/4	12	6
37321	37322	29	2-7/8	1-3/4	12	6
68381	68382	30	2-3/4	1-5/8	12	6
68391	68392	31	2-3/4	1-5/8	12	6
68401	68402	32	2-3/4	1-5/8	12	6
58441	58442	33	2-5/8	1-1/2	12	6
68411	68412	34	2-5/8	1-1/2	12	6
68421	68422	35	2-5/8	1-1/2	12	6
58581	58582	36	2-1/2	1-7/16	12	6
37721	37722	37	2-1/2	1-7/16	12	6
68431	68432	38	2-1/2	1-7/16	12	6
58451	58452	39	2-3/8	1-3/8	12	6
38321	38322	40	2-3/8	1-3/8	12	6
Type 240-P Black Oxide		LETTER			Type 240-P Black Oxide	
Part Number	Part Number	Letter Sizes	Overall Length Inches	Flute Length Inches	Qty. per/Pack	Qty. per/Pack
70880	58372	A	3-7/8	2-5/8	12	6
70890	58402	B	4	2-3/4	12	6
70900	58412	C	4	2-3/4	12	6
70910	58462	D	4	2-3/4	12	6
71950	58472	E	4	2-3/4	12	6
58481	58482	F	4-1/8	2-7/8	12	6
70920	58492	G	4-1/8	2-7/8	12	6
70930	58512	H	4-1/8	2-7/8	12	6
70940	58532	I	4-1/8	2-7/8	12	6
70950	58542	J	4-1/8	2-7/8	12	6
71960	58552	K	4-1/4	2-15/16	12	6
70960	58562	L	4-1/4	2-15/16	12	6
70970	58572	M	4-3/8	3-1/16	6	3
70980	58602	N	4-3/8	3-1/16	6	3
70990	58612	O	4-1/2	3-3/16	6	3
71000	58622	P	4-5/8	3-5/16	6	3
71010	58632	Q	4-3/4	3-7/16	6	3
71020	58642	R	4-3/4	3-7/16	6	3
71030	58652	S	4-7/8	3-1/2	6	3
71040	58662	T	4-7/8	3-1/2	6	3
71050	58672	U	5	3-5/8	6	3
71060	58732	V	5	3-5/8	6	3
71070	58682	W	5-1/8	3-3/4	6	3
72000	58692	X	5-1/8	3-3/4	6	3
71080	58702	Y	5-1/4	3-7/8	6	3
71090	58712	Z	5-1/4	3-7/8	6	3

AUTOMOTIVE SERIES TANGED DRIVE

Type 230

Automotive Series Tanged Drive
118° Point General Purpose - Black Oxide

• Tang drive used with A.S.A. split sleeve drill drivers



FRACTIONAL

Part #	Diameter Inches	Overall Length Inches	Flute Length Inches	Qty. per/pack
13300	1/8	2-3/4	1-5/8	12
13360	9/64	2-7/8	1-3/4	12
13400	5/32	3-1/8	2	12
13440	11/64	3-1/4	2-1/8	12
13490	3/16	3-1/2	2-5/16	12
13540	13/64	3-5/8	2-7/16	12
13570	7/32	3-3/4	2-1/2	12
13600	15/64	3-7/8	2-5/8	12
13630	1/4	4	2-3/4	12
13670	17/64	4-1/8	2-7/8	12
13700	9/32	4-1/4	2-15/16	12
13730	19/64	4-3/8	3-1/16	6
13760	5/16	4-1/2	3-3/16	6
13790	21/64	4-5/8	3-5/16	6
13820	11/32	4-3/4	3-7/16	6
13850	23/64	4-7/8	3-1/2	6
13870	3/8	5	3-5/8	6
13890	25/64	5-1/8	3-3/4	6
13910	13/32	5-1/4	3-7/8	6
13920	27/64	5-3/8	3-15/16	6
13930	7/16	5-1/2	4-1/16	6
13940	29/64	5-5/8	4-3/16	6
13950	15/32	5-3/4	4-5/16	6
13960	31/64	5-7/8	4-3/8	6
13970	1/2	6	4-1/2	6
13980	33/64	6-5/8	4-13/16	1
13990	17/32	6-5/8	4-13/16	1
14000	35/64	6-5/8	4-13/16	1
14010	9/16	6-5/8	4-13/16	1
14020	37/64	6-5/8	4-13/16	1
14030	19/32	7-1/8	5-3/16	1
14040	39/64	7-1/8	5-3/16	1
14050	5/8	7-1/8	5-3/16	1
14060	41/64	7-1/8	5-3/16	1
14070	21/32	7-1/8	5-3/16	1
14080	43/64	7-5/8	5-5/8	1
14090	11/16	7-5/8	5-5/8	1

Twist Drills - Automotive Series Tanged Drive

Mechanic Length



HSS 3/8" REDUCED SHANK & CAD-HD SERIES

Type 250-UB

Ultra Bor Super Premium
3-Flats on Shank - 135° Split Point

- Special Hi-Molybdenum tool steel.
- 135° split point for fast penetration and accurate starting without center punch.
- Precision ground point, flutes, body, clearance and drill diameter for the ultimate in accuracy and performance.
- Body and clearance are gold surface treated for maximum lubricity.



3 - FLATS ON SHANK

PartNo.	Diameter Inches	Overall Length Inches	Flute Length Inches	Qty. per/pack
22860	1/16	1-7/8	7/8	12
22870	5/64	2	1	12
22880	3/32	2-1/4	1-1/4	12
86950	7/64	2-3/8	1-5/16	12
86960	1/8	2-1/2	1-7/16	12
86970	9/64	2-5/8	1-9/16	12
86980	5/32	2-3/4	1-11/16	12
86990	11/64	2-7/8	1-13/16	12
87000	3/16	3	1-7/8	12
87010	13/64	3-1/8	1-15/16	12
87020	7/32	3-1/4	2	12
87030	15/64	3-3/8	2-1/16	12
87040	1/4	3-1/2	2	12
87050	17/64	3-5/8	2-1/8	12
87060	9/32	3-3/4	2-1/4	12
87070	19/64	3-7/8	2-3/8	6
87080	5/16	4	2-1/2	6
87090	21/64	4-1/16	2-9/16	6
87100	11/32	4-1/8	2-5/8	6
87110	23/64	4-3/16	2-11/16	6
87120	3/8	4-1/4	2-11/16	6
87130	25/64	4-5/16	2-3/4	6
87140	13/32	4-3/8	2-13/16	6
87150	27/64	4-7/16	2-7/8	6
87160	7/16	4-1/2	2-15/16	6
87170	29/64	4-5/8	3	6
87180	15/32	4-3/4	3-1/8	6
87190	31/64	4-7/8	3-1/4	6
87200	1/2	5	3-3/8	6

These items are also available carded.
See Price List Catalog for details.

Type 258-UB

Ultra Bor Super Premium - 135° Split Point
3-Flats on Shank - 3/8" Reduced Shank

- Reduced shank with flats for positive chuck grip.



3 - FLATS ON SHANK - 3/8" SHANK

Part #	Diameter Inches	Overall Length Inches	Flute Length Inches	Qty. per/pack
81560	13/32	4-3/8	2-13/16	6
81570	27/64	4-7/16	2-7/8	6
81580	7/16	4-1/2	2-15/16	6
81590	29/64	4-5/8	3	6
81600	15/32	4-3/4	3-1/8	6
81610	31/64	4-7/8	3-1/4	6
81620	1/2	5	3-3/8	6

25/64 250-UB drills with flats will fit a 3/8" chuck without reducing the shank diameter

These items are also available carded. See Price List Catalog for details.

Type 241-A

V-line, CAD-HD Series -
Black Oxide 135° Split Point

- American made value line drill
- New advances in drill making technology have allowed us to make an excellent drill for the very price sensitive portions of the business.
- The black surface treatment prevents chip welding and increases abrasion resistance.



Part #	Diameter Inches	Overall Length Inches	Flute Length Inches	Qty. per/pack
04492	1/16	1-7/8	7/8	12
04502	5/64	2	1	12
04512	3/32	2-1/4	1-1/4	12
04522	7/64	2-3/8	1-5/16	12
04532	1/8	2-1/2	1-7/16	12
04542	9/64	2-5/8	1-9/16	12
04552	5/32	2-3/4	1-11/16	12
04562	11/64	2-7/8	1-13/16	12
04572	3/16	2	1-1/2	12
04582	13/64	3-1/8	1-5/8	12
04592	7/32	3-1/4	1-3/4	12
04602	15/64	3-3/8	1-7/8	12
04612	1/4	3-1/2	2	12
04622	17/64	3-5/8	2-1/8	12
04632	9/32	3-3/4	2-1/4	12
04642	19/64	3-7/8	2-3/8	6
04652	5/16	4	2-1/2	6
04662	21/64	4-1/16	2-9/16	6
04672	11/32	4-1/8	2-5/8	6
04682	23/64	4-3/16	2-11/16	6
04692	3/8	4-1/4	2-11/16	6
04702	25/64	4-5/16	2-3/4	6
04712	13/32	4-3/8	2-13/16	6
04722	27/64	4-7/16	2-7/8	6
04732	7/16	4-1/2	2-15/16	6
04742	29/64	4-5/8	3	6
04752	15/32	4-3/4	3-1/8	6
04762	31/64	4-7/8	3-1/4	6
04772	1/2	5	3-3/8	6



HEX SHANK - 1/4" QUICK RELEASE

Type QR-UB

Ultra Bor Super Premium Quick Release Drills - 135° Split Point

- A mechanic length with a quick release shank
 - Special Hi-Molybdenum tool steel.
- 135° split point for fast penetration and accurate starting without center punch.
- Body and clearance are gold treated for maximum lubricity.
- Specially designed for hand held drill and impact tools.
 - Recommended use in work hardening grades of stainless steel and other hard metal drill applications.



QR-UB 1/4" HEX SHANK

Part #	Diameter Inches	Overall Length Inches	Flute Length Inches	Qty. per/pack
34501	1/16	2-5/8	7/8	6
34521	3/32	3-1/4	1-1/4	6
34541	1/8	3-1/2	1-7/16	6
34561	5/32	3-1/2	1-11/16	6
34581	3/16	3-3/4	1-7/8	6
34611	7/32	4"	2"	6
34631	1/4	4-1/4	2"	6
34651	9/32	3-13/16	2-1/4	6
34671	5/16	4"	2-1/2	3
34691	11/32	4-7/32	2-5/8	3
34711	3/8	4-1/4	2-11/16	3
34731	13/32	4-1/2	2-13/16	3
34751	7/16	4-1/2	2-15/16	3
34771	15/32	4-7/8	3-1/8	3
34791	1/2	5"	3-3/8	3
34801	Quick Release Adapter			

CARDED QR-UB 1/4" HEX SHANK

Part #	Diameter Inches	Overall Length Inches	Flute Length Inches	Qty. per/pack
34507	1/16	2-5/8	7/8	2
34527	3/32	3-1/4	1-1/4	2
34547	1/8	3-1/2	1-7/16	2
34567	5/32	3-1/2	1-11/16	2
34587	3/16	3-3/4	1-7/8	2
34617	7/32	4"	2"	1
34637	1/4	4-1/4	2"	1
34657	9/32	3-13/16	2-1/4	1
34677	5/16	4"	2-1/2	1
34697	11/32	4-7/32	2-5/8	1
34717	3/8	4-1/4	2-11/16	1
34737	13/32	4-1/2	2-13/16	1
34757	7/16	4-1/2	2-15/16	1
34777	15/32	4-7/8	3-1/8	1
34797	1/2	5"	3-3/8	1
34807	Quick Release Adapter			

NEW TYPE QR-UB EXTENSIONS

- One handed operation – Simply push your PTA into the extension and it will automatically load and lock the accessory.
- Patented All Hex connection system will hold any 1/4" hex shape including, Power Groove and Notched product
- Patented All Hex connection system holds the accessory without any wobble or play. Tight fit for a professional feel.
- **Made in the USA.**
- **Not intended for Impact Tools.**



Part No.	Size	Qty. per/pack
34821	3" Quick release Extension	1
34831	6" Quick release Extension	1
34841	12" Quick release Extension	1

SETS HEX SHANK - 1/4" QUICK RELEASE



QR-12 SET HARD CASE - INDEX

Part #	Description of Sizes	Qty of each
34811	1/16, 3/32, 1/8, 5/32, 3/16, 7/32, 1/4, 5/16, 3/8, 7/16, 1/2 & Quick Release Adaptor	1



QR-16 SET SOFT POUCH - INDEX

Part #	Description of Sizes	Qty of each
34812	1/16, 3/32, 1/8, 5/32, 3/16, 7/32, 1/4, 9/32, 5/16, 11/32, 3/8, 13/32, 7/16, 15/32, 1/2 & Quick Release Adaptor	1

QR-7A - SOFT POUCH INDEX

Part #	Description of Sizes	Qty of each
34803	1/16, 3/32, 1/8, 5/32, 3/16, 7/32, 1/4	1

QR-7B SET SOFT POUCH - INDEX

Part #	Description of Sizes	Qty of each
34804	1/8, 3/16, 1/4, 5/16, 3/8, 7/16, 1/2	1

Jobber Length



M42 COBALT-TITANIUM NITRIDE & TITANIUM ALUMINUM NITRIDE NAS 907J

Type 240-D -M42 Cobalt, Type 240-DN -Titanium Nitride

NEW Type 240-AND -Titanium Aluminum Nitride

135° Split Point - M42 Cobalt - NAS 907J

- Manufactured from M42 HSS containing 8% cobalt which increases high red hardness.
- Cobalt drills require rigidly held positive feed drilling equipment.
- Titanium Aluminum Nitride can be used in machining stainless steel, nickel based and titanium alloys, not recommended for aluminum.
- Manufactured to NAS 907J specifications.



Type 240-D

Use to drill hard, tough metals, free machining stainless steel, titanium alloys and certain abrasive plastics.



Type 240-DN

Titanium nitride for lubricity, and extended tool life.



Type 240-AND

Titanium aluminum nitride designed for use where extreme temperatures are found, allows for increased machining speeds up to 200%.

240-D Part#	240-DN TAIN Part#	240-AND TAIN Part#	Overall Diameter Inches	Flute Length Inches	Length Inches	240-D Qty. per/Pk	240-DN /240-AND Qty. per/Pk
08000	-----	-----	3/64	1-3/4	3/4	12	6
08010	79600	80003	1/16	1-7/8	7/8	12	6
08020	79610	80013	5/64	2"	1"	12	6
08030	79620	80023	3/32	2-1/4	1-1/4	12	6
08040	79630	80033	7/64	2-5/8	1-1/2	12	6
08050	79640	80043	1/8"	2-3/4	1-5/8	12	6
08060	79650	80053	9/64	2-7/8	1-3/4	12	6
08070	79660	80063	5/32	3-1/8	2"	12	6
08080	79670	80073	11/64	3-1/4	2-1/8	12	6
08090	79680	80083	3/16	3-1/2	2-5/16	12	6
08100	79690	80093	13/64	3-5/8	2-7/16	12	6
08110	79700	80103	7/32	3-3/4	2-1/2	12	6
08120	79710	80113	15/64	3-7/8	2-5/8	12	6
08130	79720	80123	1/4"	4"	2-3/4	12	6
08140	79730	80133	17/64	4-1/8	2-7/8	12	6
08150	79740	80143	9/32	4-1/4	2-15/16	12	6
08160	79750	80153	19/64	4-3/8	3-1/16	6	3
08170	79760	80163	5/16	4-1/2	3-3/16	6	3
08180	79770	80173	21/64	4-5/8	3-5/16	6	3
08190	79780	80183	11/32	4-3/4	3-7/16	6	3
08200	79790	80193	23/64	4-7/8	3-1/2	6	3
08210	79800	80203	3/8"	5"	3-5/8"	6	3
08220	79810	80213	25/64	5-1/8	3-3/4	6	3
08230	79820	80223	13/32	5-1/4	3-7/8	6	3
08240	79830	80233	27/64	5-3/8	3-15/16	6	3
08250	79840	80243	7/16"	5-1/2	4-1/16	6	3
08260	79850	80253	29/64	5-5/8	4-3/16	6	3
08270	79860	80263	15/32	5-3/4	4-5/16	6	3
08280	79870	80273	31/64	5-7/8	4-3/8	6	3
08290	79880	80283	1/2"	6"	4-1/2"	6	3

WIRE

240-D Part#	240-DN TAIN Part#	240-AND TAIN Part#	Wire Sizes	Overall Diameter Inches	Flute Length Inches	240-D Qty. per/Pk	240-DN /240-AND Qty. per/Pk
08300	77001	80553	1	3-7/8	2-5/8	12	6
08310	77011	80563	2	3-7/8	2-5/5	12	6
08320	77021	80573	3	3-3/4	2-1/2	12	6
08330	77031	80583	4	3-3/4	2-1/2	12	6
08340	77041	80593	5	3-3/4	2-1/2	12	6
08350	77051	80603	6	3-3/4	2-1/2	12	6
08360	77061	80613	7	3-5/8	2-7/16	12	6
08370	77071	80623	8	3-5/8	2-7/16	12	6
08380	77081	80633	9	3-5/8	2-7/16	12	6
08390	77091	80643	10	3-5/8	2-7/16	12	6
08400	77101	80653	11	3-1/2	2-5/16	12	6
08410	77111	80663	12	3-1/2	2-5/16	12	6
08420	77121	80673	13	3-1/2	2-5/16	12	6
08430	77131	80683	14	3-3/8	2-3/16	12	6
08440	77141	80693	15	3-3/8	2-3/16	12	6
08450	77151	80703	16	3-3/8	2-3/16	12	6
08460	77161	80713	17	3-3/8	2-3/16	12	6
08470	77171	80723	18	3-1/4	2-1/8	12	6
08480	77181	80733	19	3-1/4	2-1/8	12	6
08490	77191	80743	20	3-1/4	2-1/8	12	6
08500	77201	80753	21	3-1/4	2-1/8	12	6
08510	77211	80763	22	3-1/8	2	12	6
08520	77221	80773	23	3-1/8	2	12	6
08530	77231	80783	24	3-1/8	2	12	6
08540	77241	80793	25	3"	1-7/8	12	6
08550	77261	80803	26	3"	1-7/8	12	6
08560	77271	80813	27	3"	1-7/8	12	6
08570	77281	80823	28	2-7/8	1-3/4	12	6
08580	77291	80833	29	2-7/8	1-3/4	12	6
08590	77301	80843	30	2-3/4	1-5/8	12	6
08600	77311	80853	31	2-3/4	1-5/8	12	6
08610	77321	80863	32	2-3/4	1-5/8	12	6
08620	77331	80873	33	2-5/8	1-1/2	12	6
08630	77341	80883	34	2-5/8	1-1/2	12	6
08640	77351	80893	35	2-5/8	1-1/2	12	6
08650	77361	80903	36	2-1/2	1-7/16	12	6
08660	77371	80913	37	2-1/2	1-7/16	12	6
08670	77381	80923	38	2-1/2	1-7/16	12	6
08680	77391	80933	39	2-3/8	1-3/8	12	6
08690	77401	80943	40	2-3/8	1-3/8	12	6
08700	77411	80953	41	2-3/8	1-3/8	12	6
08710	77411	80963	42	2-1/4	1-1/4	12	6
08720	77421	80973	43	2-1/4	1-1/4	12	6
08730	77431	80983	44	2-1/8	1-1/8	12	6
08740	77441	80993	45	2-1/8	1-1/8	12	6
08750	77451	81003	46	2-1/8	1-1/8	12	6
08760	77461	81013	47	2"	1	12	6
08770	77471	81023	48	2"	1	12	6
08780	77481	81033	49	2"	1	12	6
08790	77491	81043	50	2"	1	12	6
08800	77501	81053	51	2"	1	12	6
08810	77511	81063	52	1-7/8	7/8	12	6
08820	77521	81073	53	1-7/8	7/8	12	6
08830	77531	81083	54	1-7/8	7/8	12	6
08840	77541	81093	55	1-7/8	7/8	12	6
08850	77551	81103	56	1-3/4	3/4	12	6
08860	77561	81113	57	1-3/4	3/4	12	6
08870	77571	81123	58	1-5/8	11/16	12	6
08880	77581	81133	59	1-5/8	11/16	12	6
08890	77591	81143	60	1-5/8	11/16	12	6

LETTER

240-D Part#	240-DN TAIN Part#	240-AND TAIN Part#	Letter Sizes	Overall Length Inches	Flute Length Inches	240-D Qty. per/Pk	240-DN /240-AND Qty. per/Pk
08940	79320	80293	A	3-7/8	2-5/8	12	6
08950	79330	80303	B	4"	2-3/4	12	6
08960	79340	80313	C	4"	2-3/4	12	6
08970	79350	80323	D	4"	2-3/4	12	6
08980	79360	80333	E	4"	2-3/4	12	6
08990	79370	80343	F	4-1/8	2-7/8	12	6
09000	79380	80353	G	4-1/8	2-7/8	12	6
09010	79390	80363	H	4-1/8	2-7/8	12	6
09020	79400	80373	I	4-1/8	2-7/8	12	6
09030	79410	80383	J	4-1/8	2-7/8	12	6
09040	79420	80393	K	4-1/4	2-15/16	12	6
09050	79430	80403	L	4-1/4	2-15/16	12	6
09060	79440	80413	M	4-3/8	3-3/16	6	3
09070	79450	80423	N	4-3/8	3-1/16	6	3
09080	79460	80433	O	4-1/2	3-3/16	6	3
09090	79470	80443	P	4-5/8	3-5/16	6	3
09100	79780	80453	Q	4-3/4	3-7/16	6	3
09110	79490	80463	R	4-3/4	3-7/16	6	3
09120	79500	80473	S	4-7/8	3-1/2	6	3
09130	79510	80483	T	4-7/8	3-1/2	6	3
09140	79520	80493	U	5"	3-5/8	6	3
09150	79530	80503	V	5"	3-5/8	6	3
09160	79540	80513	W	5-1/8	3-3/4	6	3
09170	79550	80523	X	5-1/8	3-3/4	6	3
09180	79560	80533	Y	5-1/4	3-7/8	6	3
09190	79570	80543	Z	5-1/4	3-7/8	6	3

TAIN

TiN

Twist Drills - M42 Cobalt Titanium Nitride/Titanium Aluminum Nitride NAS 907-J

M42 COBALT NAS 907J

Type 643-D

135° Split Point - M42 Cobalt - NAS 907J



- Manufactured from M42 HSS containing 8% cobalt which increases high hot hardness.
- Cobalt drills require rigidly held positive feed drilling equipment.
- Manufactured to NAS 907J specifications.

METRIC

Part #	Diameter		Overall Length		Flute Length		Qty. per/pack
	MM	MM	MM	Inches	MM	Inches	
27050	0.90	38	1-1/2	16	5/8	10	
27060	0.95	38	1-1/2	16	5/8	10	
27070	1.00	41	1-5/8	17	11/16	10	
27080	1.05	41	1-5/8	17	11/16	10	
27100	1.20	48	1-7/8	22	7/8	10	
27110	1.30	48	1-7/8	22	7/8	10	
08831	1.40	48	1-7/8	22	7/8	10	
27130	1.50	48	1-7/8	22	7/8	10	
27140	1.60	48	1-7/8	22	7/8	10	
27150	1.70	51	2	25	1	10	
27160	1.80	51	2	25	1	10	
27170	1.90	51	2	25	1	10	
26460	2.00	51	2	25	1	10	
26940	2.05	54	2-1/8	25	1-5/32	10	
26470	2.10	54	2-1/8	29	1-5/32	10	
26480	2.20	57	2-1/4	32	1-1/4	10	
26490	2.30	57	2-1/4	32	1-1/4	10	
26500	2.40	60	2-23/64	35	1-3/8	10	
26510	2.50	60	2-23/64	35	1-3/8	10	
26520	2.60	64	2-1/2	37	1-29/64	10	
26530	2.70	64	2-1/2	37	1-15/32	10	
26540	2.80	67	2-5/8	38	1-1/2	10	
26550	2.90	70	2-3/4	41	1-5/8	10	
26560	3.00	70	2-3/4	41	1-5/8	10	
26570	3.10	70	2-3/4	41	1-5/8	10	
26580	3.20	70	2-3/4	41	1-5/8	10	
26590	3.30	73	2-7/8	45	1-3/4	10	
26600	3.40	73	2-7/8	45	1-3/4	10	
26610	3.50	73	2-7/8	45	1-3/4	10	
26620	3.60	76	3	48	1-7/8	10	
26630	3.70	76	3	48	1-7/8	10	
26640	3.80	76	3	48	1-7/8	10	
26650	3.90	79	3-1/8	51	2	10	
26660	4.00	83	3-1/4	54	2-1/8	10	
26670	4.10	83	3-1/4	54	2-1/8	10	
26680	4.20	83	3-1/4	54	2-1/8	10	
26690	4.30	83	3-1/4	54	2-1/8	10	
34570	4.40	86	3-3/8	56	2-13/64	10	
26700	4.50	86	3-3/8	56	2-13/64	10	
26710	4.60	86	3-3/8	56	2-13/64	10	
26720	4.70	89	3-1/2	59	2-21/64	10	
26730	4.80	89	3-1/2	59	2-21/64	10	
26740	4.90	92	3-5/8	62	2-7/16	10	
26750	5.00	92	3-5/8	62	2-7/16	10	
33960	5.10	92	3-5/8	62	2-7/16	10	
33970	5.20	95	3-3/4	64	2-1/2	10	
33980	5.30	95	3-3/4	64	2-1/2	10	
33990	5.40	95	3-3/4	64	2-1/2	10	
34000	5.50	95	3-3/4	64	2-1/2	10	
34010	5.60	98	3-7/8	67	2-5/8	10	
34020	5.70	98	3-7/8	67	2-5/8	10	
34030	5.80	98	3-7/8	67	2-5/8	10	
34040	5.90	98	3-7/8	67	2-5/8	10	
34050	6.00	102	4	70	2-3/4	10	
34060	6.10	102	4	70	2-3/4	10	
34070	6.20	102	4	70	2-3/4	10	
34080	6.30	102	4	70	2-3/4	10	

Part #	Diameter		Overall Length		Flute Length		Qty. per/pack
	MM	MM	MM	Inches	MM	Inches	
34090	6.40	105	4-1/8	73	2-7/8	10	
34100	6.50	105	4-1/8	73	2-7/8	10	
34110	6.60	105	4-1/8	73	2-7/8	10	
34120	6.70	105	4-1/8	73	2-7/8	10	
34130	6.80	105	4-1/8	73	2-7/8	10	
34140	6.90	105	4-1/8	73	2-7/8	10	
34150	7.00	105	4-1/8	73	2-7/8	10	
34160	7.10	108	4-1/4	75	2-61/64	10	
34170	7.20	108	4-1/4	75	2-61/64	10	
34180	7.30	108	4-1/4	75	2-61/64	10	
34190	7.40	111	4-3/8	78	3	10	
34200	7.50	111	4-3/8	78	3	5	
34210	7.60	111	4-3/8	78	3	5	
34220	7.70	114	4-1/2	81	3-3/16	5	
34230	7.80	114	4-1/2	81	3-3/16	5	
34240	7.90	114	4-1/2	81	3-3/16	5	
34250	8.00	114	4-1/2	81	3-3/16	5	
34260	8.10	117	4-9/16	84	3-5/16	5	
34270	8.20	117	4-9/16	84	3-5/16	5	
34280	8.30	117	4-9/16	84	3-5/16	5	
34290	8.40	121	4-3/4	87	3-27/64	5	
34300	8.50	121	4-3/4	87	3-27/64	5	
34310	8.60	121	4-3/4	87	3-27/64	5	
34320	8.70	121	4-3/4	87	3-27/64	5	
34330	8.80	124	4-7/8	89	3-1/2	5	
34340	8.90	124	4-7/8	89	3-1/2	5	
34350	9.00	124	4-7/8	89	3-1/2	5	
34360	9.10	124	4-7/8	89	3-1/2	5	
34370	9.20	127	5	92	3-5/8	5	
34380	9.30	127	5	92	3-5/8	5	
34390	9.40	127	5	92	3-5/8	5	
34400	9.50	127	5	92	3-5/8	5	
34410	9.60	130	5-1/8	95	3-3/4	5	
34420	9.70	130	5-1/8	95	3-3/4	5	
34430	9.80	130	5-1/8	95	3-3/4	5	
34450	10.00	130	5-1/8	95	3-3/4	5	
34452	10.10	133	5-15/64	98	3-7/8	5	
34460	10.20	133	5-15/64	98	3-7/8	5	
34461	10.30	133	5-15/64	98	3-7/8	5	
34470	10.50	133	5-15/64	98	3-7/8	5	
34512	10.70	136	5-3/8	100	3-15/16	5	
34480	10.80	140	5-1/2	103	4-1/16	5	
34482	10.90	140	5-1/2	103	4-1/16	5	
34490	11.00	140	5-1/2	103	4-1/16	5	
34492	11.10	140	5-1/2	103	4-1/16	5	
34500	11.20	143	5-5/8	106	4-7/32	5	
34504	11.40	143	5-5/8	106	4-7/32	5	
34510	11.50	143	5-5/8	106	4-7/32	5	
34514	11.60	146	5-3/4	110	4-11/32	5	
34519	11.70	146	5-3/4	110	4-11/32	5	
34520	11.80	146	5-3/4	110	4-11/32	5	
34530	12.00	149	5-7/8	111	4-3/8	5	
34540	12.20	149	5-7/8	111	4-3/8	5	
34542	12.30	149	5-7/8	111	4-3/8	5	
34544	12.40	152	6	114	4-1/2	5	
34550	12.50	152	6	114	4-1/2	5	
34552	12.60	152	6	114	4-1/2	5	
34580	12.70	152	6	114	4-1/2	5	
34560	13.00	152	6	114	4-1/2	5	

METRIC

Twist Drills - M42 Cobalt NAS 907-J

HSS M42 COBALT DIN 338

Type XGT-J

DIN 338 Length - 135° Split Point
M-42 Cobalt High Speed Steel

- Gyroidal Torsion flute and wide land construction yields exceptional performance in deep hole drilling.
- Recommended for a wide range of steels, castings and other hard metal drilling applications.
- Cobalt steel is abrasion and heat resistant.
- Allows deep hole drilling without drill retraction.

* M2 Titanium Nitride sizes 1.00 - 1.59mm



Type XGT-J

Heavy duty wide land parabolic.

METRIC

Twist Drills - HSS M42 Cobalt DIN 338

METRIC

Part #	Dia. MM	Frac/Wire/Letter	Overall Length MM	Inches	Flute Length MM	Inches	Qty. per/pack
*00200	1.00		41	1 5/8	17	11/16	10
*00201	1.02	60	41	1 5/8	17	11/16	10
*00202	1.04	59	41	1 5/8	17	11/16	10
*00203	1.05		41	1 5/8	17	11/16	10
*00204	1.07	58	41	1 5/8	17	11/16	10
*00210	1.09	57	44	1 3/4	19	3/4	10
*00211	1.10		44	1 3/4	19	3/4	10
*00212	1.15		44	1 3/4	19	3/4	10
*00213	1.18	56	44	1 3/4	19	3/4	10
*00214	1.19	3/64	44	1 3/4	19	3/4	10
*00220	1.20		48	1 7/8	22	7/8	10
*00221	1.25		48	1 7/8	22	7/8	10
*00222	1.30		48	1 7/8	22	7/8	10
*00223	1.32	55	48	1 7/8	22	7/8	10
*00224	1.35		48	1 7/8	22	7/8	10
*00230	1.40	54	48	1 7/8	22	7/8	10
*00232	1.45		48	1 7/8	22	7/8	10
*00233	1.50		48	1 7/8	22	7/8	10
*00234	1.51	53	48	1 7/8	22	7/8	10
*00240	1.55		48	1 7/8	22	7/8	10
00241	1.59	1/16	48	1 7/8	22	7/8	10
00242	1.60		48	1 7/8	22	7/8	10
00243	1.61	52	48	1 7/8	22	7/8	10
00244	1.65		51	2	25	1	10
00250	1.70	51	51	2	25	1	10
00252	1.75		51	2	25	1	10
00253	1.78	50	51	2	25	1	10
00254	1.80		51	2	25	1	10
00260	1.85	49	51	2	25	1	10
00262	1.90		51	2	25	1	10
00263	1.93	48	51	2	25	1	10
00264	1.95		51	2	25	1	10
00270	1.98	5/64	51	2	25	1	10
00271	1.99	47	51	2	25	1	10
00272	2.00		51	2	25	1	10
00273	2.05		54	2 1/8	29	1 5/32	10
00274	2.06	46	54	2 1/8	29	1 5/32	10
00280	2.08	45	54	2 1/8	29	1 5/32	10
00281	2.10		54	2 1/8	29	1 5/32	10
00282	2.15		54	2 1/8	29	1 5/32	10
00283	2.18	44	54	2 1/8	29	1 5/32	10
00284	2.20		57	2 1/4	32	1 1/4	10
00290	2.25		57	2 1/4	32	1 1/4	10
00291	2.26	43	57	2 1/4	32	1 1/4	10
00292	2.30		57	2 1/4	32	1 1/4	10
00293	2.35		57	2 1/4	32	1 1/4	10
00294	2.37	42	57	2 1/4	30	1 3/16	10
00300	2.38	3/32	57	2 1/4	30	1 3/16	10
00301	2.40		57	2 1/4	30	1 3/16	10
00302	2.44	41	57	2 1/4	30	1 3/16	10
00303	2.45		57	2 1/4	30	1 3/16	10
00304	2.49	40	57	2 1/4	30	1 3/16	10
00310	2.50		57	2 1/4	30	1 3/16	10
00311	2.53	39	57	2 1/4	30	1 3/16	10
00231	2.55		57	2 1/4	30	1 3/16	10
00312	2.58	38	57	2 1/4	30	1 3/16	10
00313	2.60		57	2 1/4	30	1 3/16	10
00314	2.64	37	57	2 1/4	30	1 3/16	10
00251	2.65		57	2 1/4	30	1 3/16	10
00320	2.70		61	2 13/32	33	1 19/64	10
00321	2.71	36	61	2 13/32	33	1 19/64	10
00261	2.75		61	2 13/32	33	1 19/64	10
00322	2.78	7/64	61	2 13/32	33	1 19/64	10
00323	2.79	35	61	2 13/32	33	1 19/64	10
00324	2.80		61	2 13/32	33	1 19/64	10

Part #	Dia. MM	Frac/Wire/Letter	Overall Length MM	Inches	Flute Length MM	Inches	Qty. per/pack
00330	2.82	34	61	2 13/32	33	1 19/64	10
00360	2.85		61	2 13/32	33	1 19/64	10
00331	2.87	33	61	2 13/32	33	1 19/64	10
00332	2.90		61	2 13/32	33	1 19/64	10
00333	2.95	32	61	2 13/32	33	1 19/64	10
00334	3.00		61	2 13/32	33	1 19/64	10
00340	3.05	31	65	2 9/16	36	1 7/16	10
00341	3.10		65	2 9/16	36	1 7/16	10
00342	3.17	1/8	65	2 9/16	36	1 7/16	10
00343	3.20		65	2 9/16	36	1 7/16	10
00371	3.25		65	2 9/16	36	1 7/16	10
00344	3.26	30	65	2 9/16	36	1 7/16	10
00350	3.30		65	2 9/16	36	1 7/16	10
00351	3.40		70	2 3/4	39	1 7/32	10
00352	3.45	29	70	2 3/4	39	1 7/32	10
00353	3.50		70	2 3/4	39	1 7/32	10
00354	3.57	9/64-28	70	2 3/4	39	1 7/32	10
00361	3.60		70	2 3/4	39	1 7/32	10
00362	3.66	27	70	2 3/4	39	1 7/32	10
00363	3.70		70	2 3/4	39	1 7/32	10
00364	3.73	26	70	2 3/4	39	1 7/32	10
00370	3.80	25	75	2 15/16	43	1 11/16	10
00372	3.86	24	75	2 15/16	43	1 11/16	10
00373	3.90		75	2 15/16	43	1 11/16	10
00374	3.91	23	75	2 15/16	43	1 11/16	10
00380	3.97	5/32	75	2 15/16	43	1 11/16	10
00381	3.99	22	75	2 15/16	43	1 11/16	10
00382	4.00		75	2 15/16	43	1 11/16	10
00383	4.04	21	75	2 15/16	43	1 11/16	10
00384	4.09	20	75	2 15/16	43	1 11/16	10
00390	4.10		75	2 15/16	43	1 11/16	10
00391	4.15		75	2 15/16	43	1 11/16	10
00392	4.20		75	2 15/16	43	1 11/16	10
00393	4.22	19	75	2 15/16	43	1 11/16	10
00480	4.25		75	2 15/16	43	1 11/16	10
00394	4.30		80	3 5/32	47	1 27/32	10
00680	4.31	18	80	3 5/32	47	1 27/32	10
00400	4.37	11/64	80	3 5/32	47	1 27/32	10
00401	4.39	17	80	3 5/32	47	1 27/32	10
00402	4.40		80	3 5/32	47	1 27/32	10
00403	4.50	16	80	3 5/32	47	1 27/32	10
00404	4.55		80	3 5/32	47	1 27/32	10
00410	4.57	15	80	3 5/32	47	1 27/32	10
00411	4.60		80	3 5/32	47	1 27/32	10
00412	4.62	14	80	3 5/32	47	1 27/32	10
00413	4.70	13	80	3 5/32	47	1 27/32	10
00414	4.75		80	3 5/32	47	1 27/32	10
00420	4.76	3/16	86	3 3/8	52	2 1/16	10
00421	4.80	12	86	3 3/8	52	2 1/16	10
00423	4.85	11	86	3 3/8	52	2 1/16	10
00424	4.90		86	3 3/8	52	2 1/16	10
00430	4.91	10	86	3 3/8	52	2 1/16	10
00431	4.98	9	86	3 3/8	52	2 1/16	10
00432	5.00		86	3 3/8	52	2 1/16	10
00433	5.05	8	86	3 3/8	52	2 1/16	10
00434	5.10		86	3 3/8	52	2 1/16	10
00440	5.11	7	86	3 3/8	52	2 1/16	10
00441	5.16	13/64	86	3 3/8	52	2 1/16	10
00442	5.18	6	86	3 3/8	52	2 1/16	10
00443	5.20		86	3 3/8	52	2 1/16	10
00444	5.22	5	86	3 3/8	52	2 1/16	10
00481	5.25		86	3 3/8	52	2 7/32	10
00450	5.30		93	3 21/32	57	2 7/32	10
00451	5.31	4	93	3 21/32	57	2 7/32	10
00452	5.40		93	3 21/32	57	2 7/32	10
00453	5.41	3	93	3 21/32	57	2 7/32	10
00454	5.50		93	3 21/32	57	2 7/32	10
00460	5.56	7/32	93	3 21/32	57	2 7/32	10

Metric sizes continued on page 33

METRIC

Part #	Dia. MM	Frac/Wire/Letter	Overall Length Inches	Flute Length Inches	Qty. per/pack
00461	5.60		3 21/32	57 2 7/32	10
00462	5.61	2	3 21/32	57 2 7/32	10
00463	5.70		3 21/32	57 2 7/32	10
00482	5.75		3 21/32	57 2 7/32	10
00464	5.79	1	3 21/32	57 2 7/32	10
00470	5.80		3 21/32	57 2 7/32	10
00471	5.90		3 21/32	57 2 7/32	10
00472	5.94	A	3 21/32	57 2 7/32	10
00473	5.95	15/64	3 21/32	57 2 7/32	10
00474	6.00		3 21/32	57 2 7/32	10
00483	6.05	B	3 31/32	63 2 15/32	10
00484	6.10		3 31/32	63 2 15/32	10
00490	6.15	C	3 31/32	63 2 15/32	10
00491	6.20		3 31/32	63 2 15/32	10
00492	6.25	D	3 31/32	63 2 15/32	10
00493	6.30		3 31/32	63 2 15/32	10
00494	6.35	1/4-E	3 31/32	63 2 15/32	10
00500	6.40		3 31/32	63 2 15/32	10
00501	6.50		3 31/32	63 2 15/32	10
00502	6.53	F	3 31/32	63 2 15/32	10
00503	6.60		3 31/32	63 2 15/32	10
00504	6.63	G	3 31/32	63 2 15/32	10
00510	6.70		3 31/32	63 2 15/32	10
00511	6.75	17/64-H	4 9/32	69 2 23/32	10
00513	6.80		4 9/32	69 2 23/32	10
00514	6.90	I	4 9/32	69 2 23/32	10
00520	7.00		4 9/32	69 2 23/32	10
00521	7.04	J	4 9/32	69 2 23/32	10
00522	7.10		4 9/32	69 2 23/32	10
00524	7.14	9/32-K	4 9/32	69 2 23/32	10
00530	7.20		4 9/32	69 2 23/32	10
00531	7.30		4 9/32	69 2 23/32	10
00532	7.37	L	4 9/32	69 2 23/32	10
00533	7.40		4 9/32	69 2 23/32	10
00540	7.50	M	4 9/32	69 2 23/32	5
00541	7.54	19/64	4 19/32	75 2 15/16	5
00542	7.60		4 19/32	75 2 15/16	5
00543	7.67	N	4 19/32	75 2 15/16	5
00544	7.70		4 19/32	75 2 15/16	5
00550	7.80		4 19/32	75 2 15/16	5
00551	7.90		4 19/32	75 2 15/16	5
00552	7.94	5/16	4 19/32	75 2 15/16	5
00553	8.00	O	4 19/32	75 2 15/16	5
00554	8.03		4 19/32	75 2 15/16	5
00560	8.10	P	4 19/32	75 2 15/16	5
00561	8.20		4 19/32	75 2 15/16	5
00562	8.30		4 19/32	75 2 15/16	5
00563	8.33	21/64	4 19/32	75 2 15/16	5
00564	8.40		4 19/32	75 2 15/16	5
00570	8.43	Q	4 19/32	75 2 15/16	5
00571	8.50		4 19/32	75 2 15/16	5
00572	8.60	R	4 29/32	81 3 3/16	5
00573	8.70		4 29/32	81 3 3/16	5
00574	8.73	11/32	4 29/32	81 3 3/16	5
00580	8.80		4 29/32	81 3 3/16	5
00581	8.84	S	4 29/32	81 3 3/16	5
00582	8.90		4 29/32	81 3 3/16	5
00583	9.00		4 29/32	81 3 3/16	5
00584	9.10	T	4 29/32	81 3 3/16	5
00590	9.13	23/64	4 29/32	81 3 3/16	5
00591	9.20		4 29/32	81 3 3/16	5
00592	9.30		4 29/32	81 3 3/16	5
00593	9.35	U	4 29/32	81 3 3/16	5
00594	9.40		4 29/32	81 3 3/16	5
00600	9.50		4 29/32	81 3 3/16	5
00601	9.52	3/8	4 29/32	87 3 7/16	5
00602	9.58	V	4 29/32	87 3 7/16	5
00603	9.60		5 1/4	87 3 7/16	5
00604	9.70		5 1/4	87 3 7/16	5
00610	9.80	W	5 1/4	87 3 7/16	5
00611	9.90		5 1/4	87 3 7/16	5
00612	9.92	25/64	5 1/4	87 3 7/16	5
00613	10.00		5 1/4	87 3 7/16	5

HSS M42 COBALT DIN 338

Type XGT-J METRIC

DIN 338 Length - 135° Split Point
M-42 Cobalt High-Speed Steel

Part #	Dia. MM	Frac/Wire/Letter	Overall Length Inches	Flute Length Inches	Qty. per/pack
00614	10.08	X	133 5 1/4	87 3 7/16	5
00620	10.10		133 5 1/4	87 3 7/16	5
00621	10.20		133 5 1/4	87 3 7/16	5
00622	10.26	Y	133 5 1/4	87 3 7/16	5
00623	10.30		133 5 1/4	87 3 7/16	5
00624	10.32	13/32	133 5 1/4	87 3 7/16	5
00630	10.40		133 5 1/4	87 3 7/16	5
00631	10.50	Z	133 5 1/4	87 3 7/16	5
00632	10.60		133 5 1/4	87 3 7/16	5
00633	10.70		142 5 19/32	94 3 11/16	5
00634	10.72	27/64	142 5 19/32	94 3 11/16	5
00640	10.80		142 5 19/32	94 3 11/16	5
00641	10.90		142 5 19/32	94 3 11/16	5
00642	11.00		142 5 19/32	94 3 11/16	5
00643	11.10		142 5 19/32	94 3 11/16	5
00644	11.11	7/16	142 5 19/32	94 3 11/16	5
00650	11.20		142 5 19/32	94 3 11/16	5
00651	11.30		142 5 19/32	94 3 11/16	5
00652	11.40		142 5 19/32	94 3 11/16	5
00653	11.50		142 5 19/32	94 3 11/16	5
00654	11.51	29/64	142 5 19/32	94 3 11/16	5
00660	11.60		142 5 19/32	94 3 11/16	5
00661	11.70		142 5 19/32	94 3 11/16	5
00662	11.75		142 5 19/32	94 3 11/16	5
00663	11.80		142 5 19/32	94 3 11/16	5
00664	11.91	15/32	151 5 15/16	101 3 31/32	5
00670	12.00		151 5 15/16	101 3 31/32	5
00671	12.30	31/64	151 5 15/16	101 3 31/32	5
00672	12.50		151 5 15/16	101 3 31/32	5
00673	12.70	1/2	151 5 15/16	101 3 31/32	5
00674	13.00		151 5 15/16	101 3 31/32	5

HSS M42 COBALT DIN 338

Type XGT-JN TiN Titanium Nitride

DIN 338 Length - 135° Split Point M-42 Cobalt



Part No.	Diameter Inches	Overall Length Inches	Flute Length Inches	Qty. per/pack
38603	1/16	1-7/8	7/8	10
38613	5/64	2	1	10
38623	3/32	2-1/4	1-3/16	10
38633	7/64	2-13/32	1-19/64	10
38643	1/8	2-9/16	1-7/16	10
38653	9/64	2-3/4	1-17/32	10
38663	5/32	2-15/16	1-11/16	10
38673	11/64	3-5/32	1-27/32	10
38683	3/16	3-3/8	2-1/16	10
38693	13/64	3-1/8	2-1/16	10
38703	7/32	3-21/32	2-7/32	10
38713	15/64	3-21/32	2-7/32	10
38723	1/4	3-31/32	2-15/32	10
38733	17/64	4-9/32	2-23/32	10
38743	9/32	4-9/32	2-23/32	10
38753	19/64	4-19/32	2-15/16	5
38763	5/16	4-19/32	2-15/16	5
38773	21/64	4-19/32	2-15/16	5
38783	11/32	4-29/32	3-3/16	5
38793	23/64	4-29/32	3-3/16	5
38803	3/8	4-29/32	3-7/16	5
38813	25/64	5-1/4	3-7/16	5
38823	13/32	5-1/4	3-7/16	5
38833	27/64	5-19/32	3-11/16	5
38843	7/16	5-19/32	3-11/16	5
38853	29/64	5-19/32	3-11/16	5
38863	15/32	5-15/16	3-31/32	5
38873	31/64	5-15/16	3-31/32	5
38883	1/2	5-15/16	3-31/32	5

METRIC
Twist Drills - HSS M42 Cobalt DIN 338

Screw Machine Length



M42 COBALT - TiN & TITANIUM ALUMINUM NITRIDE SCREW MACHINE

Type 260-D - M42 Cobalt, Type 260-DN -Titanium Nitride, Type 260-AND -Titanium Aluminum Nitride NEW
 135° Split Point - M42 Cobalt Steel

- Manufactured from M42 HSS contains 8% Cobalt increasing hot hardness.
- High hot hardness of cobalt permits speeds 30% over regular high-speed steel drills.
- Titanium Aluminum Nitride can be used in machining stainless steel, nickel based and titanium alloys, not recommended for aluminum.



Type 260-D

Use to drill hard, tough metals, free machining stainless steel, titanium alloys and certain abrasive plastics.



Type 260-DN

TiN coating for lubricity, abrasion resistance extended tool life.



Type 260-AND

Titanium aluminum nitride designed for use where extreme temperatures are found, allows for increased machining speeds up to 200%.

WIRE

Type 260-D Part #	Diameter Inches	Overall Length Inches	Flute Length Inches	Qty. per/pack
40090	1	2-7/16	1-5/16	12
40100	2	2-7/16	1-5/16	12
40110	3	2-3/8	1-1/4	12
40120	4	2-3/8	1-1/4	12
40130	5	2-3/8	1-1/4	12
40140	6	2-3/8	1-1/4	12
40150	7	2-1/4	1-3/16	12
40160	8	2-1/4	1-3/16	12
40170	9	2-1/4	1-3/16	12
40180	10	2-1/4	1-3/16	12
40190	11	2-1/4	1-3/16	12
40200	12	2-1/4	1-3/16	12
40210	13	2-3/16	1-1/8	12
40220	14	2-3/16	1-1/8	12
40230	15	2-3/16	1-1/8	12
40240	16	2-3/16	1-1/8	12
40250	17	2-3/16	1-1/8	12
40260	18	2-1/8	1-1/16	12
40270	19	2-1/8	1-1/16	12
40280	20	2-1/8	1-1/16	12
40290	21	2-1/8	1-1/16	12
40300	22	2-1/8	1-1/16	12
40310	23	2-1/16	1	12
40320	24	2-1/16	1	12
40330	25	2-1/16	1	12
40340	26	2-1/16	1	12
40350	27	2-1/16	1	12
40360	28	1-15/16	15/16	12
40370	29	1-15/16	15/16	12
40380	30	1-15/16	15/16	12
40390	31	1-7/8	7/8	12
40400	32	1-7/8	7/8	12
40410	33	1-7/8	7/8	12
40420	34	1-7/8	7/8	12
40430	35	1-7/8	7/8	12
40440	36	1-13/16	13/16	12
40450	37	1-13/16	13/16	12
40460	38	1-13/16	13/16	12
40470	39	1-13/16	13/16	12
40480	40	1-13/16	13/16	12
42410	41	1-13/16	13/16	12
42420	42	1-3/4	3/4	12
42430	43	1-3/4	3/4	12
42440	44	1-3/4	3/4	12
42450	45	1-3/4	3/4	12
42460	46	1-3/4	3/4	12
42470	47	1-3/4	3/4	12
42480	48	1-11/16	11/16	12
42490	49	1-11/16	11/16	12
42500	50	1-11/16	11/16	12
42510	51	1-11/16	11/16	12
42520	52	1-11/16	11/16	12
42530	53	1-5/8	5/8	12
42540	54	1-5/8	5/8	12
42550	55	1-5/8	5/8	12
42560	56	1-3/8	1/2	12
42570	57	1-3/8	1/2	12
42580	58	1-3/8	1/2	12
42590	59	1-3/8	1/2	12
42600	60	1-3/8	1/2	12

260-D Part #	260-DN TiN Part#	260-AND TiAlN Part#	Overall Dia. Inches	Flute Length Inches	Length Inches	260-D Qty. per/Pk	260-DN / 260-AND Qty. per/Pk
39800	81800	37103	1/16	1-5/8	5/8	12	6
39810	81810	37113	5/64	1-11/16	11/16	12	6
39820	81820	37123	3/32	1-3/4	3/4	12	6
39830	81830	37133	7/64	1-13/16	13/16	12	6
39840	81840	37143	1/8"	1-7/8	7/8	12	6
39850	81850	37153	9/64	1-15/16	15/16	12	6
39860	81860	37163	5/32	2-1/16	1	12	6
39870	81870	37173	11/64	2-1/8	1-1/16	12	6
39880	81880	37183	3/16	2-3/16	1-1/8	12	6
39890	81890	37193	13/64	2-1/4	1-3/16	12	6
39900	81900	37203	7/32	2-3/8	1-1/4	12	6
39910	81910	37213	15/64	2-7/16	1-5/16	12	6
39920	81920	37223	1/4"	2-1/2	1-3/8	12	6
39930	81930	37233	17/64	2-5/8	1-7/16	12	6
39940	81940	37243	9/32	2-11/16	1-1/2	12	6
39950	81950	37253	19/64	2-3/4	1-9/16	6	3
39960	81960	37263	5/16	2-13/16	1-5/8	6	3
39970	81970	37273	21/64	2-15/16	1-11/16	6	3
39980	81980	37283	11/32	3	1-11/16	6	3
39990	81990	37293	23/64	3-1/16	1-3/4	6	3
40000	82000	37303	3/8"	3-1/8	1-13/16	6	3
40010	82010	37313	25/64	3-1/4	1-7/8	6	3
40020	82020	37323	13/32	3-5/16	1-15/16	6	3
40030	82030	37333	27/64	3-3/8	2	6	3
40040	82040	37343	7/16"	3-7/16	2-1/16	6	3
40050	82050	37353	29/64	3-9/16	2-1/8	6	3
40060	82060	37363	15/32	3-5/8	2-1/8	6	3
40070	82070	37373	31/64	3-11/16	2-3/16	6	3
40080	82080	37383	1/2"	3-3/4	2-1/4	6	3
51630	----	----	33/64	3-7/8	2-3/8	1	--
51640	----	----	17/32	3-7/8	2-3/8	1	--
51650	----	----	35/64	4	2-1/2	1	--
51660	----	----	9/16	4	2-1/2	1	--
51670	----	----	37/64	4-1/8	2-5/8	1	--
51680	----	----	19/32	4-1/8	2-5/8	1	--
51690	----	----	39/64	4-1/4	2-3/4	1	--
51700	----	----	5/8"	4-1/4	2-3/4	1	--
51710	----	----	41/64	4-1/2	2-7/8	1	--
51720	----	----	21/32	4-1/2	2-7/8	1	--
51730	----	----	43/64	4-1/2	2-7/8	1	--
51740	----	----	11/16	4-1/2	2-7/8	1	--
51750	----	----	45/64	4-3/4	3	1	--
51760	----	----	23/32	4-3/4	3	1	--
51770	----	----	47/64	5	3-1/8	1	--
51780	----	----	3/4"	5	3-1/8	1	--

Proudly Manufactured in the U.S.A • America's Finest High Speed Steel Cutting Tools™ • Call Toll Free

www.vikingdrill.com

1.800.328.4655

NAS 907C - SCREW MACHINE

Type 260-UB

Ultra Bor Super Premium,
NAS 907C 135° Split Point

- Special Hi-Moybdenum tool steel.
- Gold surface treated body and clearance for maximum lubricity.
- Heavy-duty construction, 135° split point, no center punch needed - will not walk.
- Recommended for work hardening grades of stainless steel and other hard metal drilling applications.



FRACTIONAL

Part #	Diameter Inches	Overall Length Inches	Flute Length Inches	Qty. per/pack
87710	1/16	1-5/8	5/8	12
87720	5/64	1-11/16	11/16	12
87730	3/32	1-3/4	3/4	12
87740	7/64	1-13/16	13/16	12
87750	1/8	1-7/8	7/8	12
87760	9/64	1-15/16	15/16	12
87770	5/32	2-1/16	1	12
87780	11/64	2-1/8	1-1/16	12
87790	3/16	2-3/16	1-1/8	12
87800	13/64	2-1/4	1-3/16	12
87810	7/32	2-3/8	1-1/4	12
87820	15/64	2-7/16	1-5/16	12
87830	1/4	2-1/2	1-3/8	12
87840	17/64	2-5/8	1-7/16	12
87850	9/32	2-11/16	1-1/2	12
87860	19/64	2-3/4	1-9/16	6
87870	5/16	2-13/16	1-5/8	6
87880	21/64	2-15/16	1-11/16	6
87890	11/32	3	1-11/16	6
87900	23/64	3-1/16	1-3/4	6
87910	3/8	3-1/8	1-13/16	6
87920	25/64	3-1/4	1-7/8	6
87930	13/32	3-5/16	1-15/16	6
87940	27/64	3-3/8	2	6
87950	7/16	3-7/16	2-1/16	6
87960	29/64	3-9/16	2-1/8	6
87970	15/32	3-5/8	2-1/8	6
87980	31/64	3-11/16	2-3/16	6
87990	1/2	3-3/4	2-1/4	6
88000	33/64	3-7/8	2-3/8	1
88010	17/32	3-7/8	2-3/8	1
88020	35/64	4	2-1/2	1
88030	9/16	4	2-1/2	1
88040	37/64	4-1/8	2-5/8	1
88050	19/32	4-1/8	2-5/8	1
88060	39/64	4-1/4	2-3/4	1
88070	5/8	4-1/4	2-3/4	1
88080	41/64	4-1/2	2-7/8	1
88090	21/32	4-1/2	2-7/8	1
89210	43/64	4-1/2	2-7/8	1
89220	11/16	4-1/2	2-7/8	1
89230	45/64	4-3/4	3	1
89240	23/32	4-3/4	3	1
89250	47/64	5	3-1/8	1
89260	3/4	5	3-1/8	1

WIRE

Part #	Wire Sizes	Overall Length Inches	Flute Length Inches	Qty. per/pack
87600	1	2-7/16	1-5/16	12
87590	2	2-7/16	1-5/16	12
87580	3	2-3/8	1-1/4	12
87570	4	2-3/8	1-1/4	12
87560	5	2-3/8	1-1/4	12
87550	6	2-3/8	1-1/4	12
87540	7	2-1/4	1-3/16	12
87530	8	2-1/4	1-3/16	12
87520	9	2-1/4	1-3/16	12
87510	10	2-1/4	1-3/16	12
87500	11	2-1/4	1-3/16	12
87490	12	2-1/4	1-3/16	12
87480	13	2-3/16	1-1/8	12
87470	14	2-3/16	1-1/8	12
87460	15	2-3/16	1-1/8	12
87450	16	2-3/16	1-1/8	12
87440	17	2-3/16	1-1/8	12
87430	18	2-1/8	1-1/16	12
87420	19	2-1/8	1-1/16	12
87410	20	2-1/8	1-1/16	12
87400	21	2-1/8	1-1/16	12
87390	22	2-1/8	1-1/16	12
87380	23	2-1/16	1	12
87370	24	2-1/16	1	12
87360	25	2-1/16	1	12
87350	26	2-1/16	1	12
87340	27	2-1/16	1	12
87330	28	1-15/16	15/16	12
87320	29	1-15/16	15/16	12
87310	30	1-15/16	15/16	12
87300	31	1-7/8	7-8	12
87290	32	1-7/8	7-8	12
87280	33	1-7/8	7-8	12
87270	34	1-7/8	7-8	12
87260	35	1-7/8	7-8	12
87250	36	1-13/16	13/16	12
87240	37	1-13/16	13/16	12
87230	38	1-13/16	13/16	12
87220	39	1-13/16	13/16	12
87210	40	1-13/16	13/16	12
23360	41	1-13/16	13/16	12
23370	42	1-3/4	3/4	12
23380	43	1-3/4	3/4	12
23390	44	1-3/4	3/4	12
23400	45	1-3/4	3/4	12
23410	46	1-3/4	3/4	12
23420	47	1-3/4	3/4	12
23430	48	1-11/16	11/16	12
23440	49	1-11/16	11/16	12
23450	50	1-11/16	11/16	12
23460	51	1-11/16	11/16	12
23470	52	1-11/16	11/16	12
23480	53	1-5/8	5/8	12
23490	54	1-5/8	5/8	12
23500	55	1-5/8	5/8	12
23510	56	1-3/8	1/2	12
23520	57	1-3/8	1/2	12
23530	58	1-3/8	1/2	12
23540	59	1-3/8	1/2	12
23550	60	1-3/8	1/2	12

Letter sizes continued on page 36

Screw Machine Length



SCREW MACHINE & HEAVY-DUTY 1/4" REDUCED SHANK

Type 260-UB

Ultra Bor Super Premium,
NAS 907C 135° Split Point

- Special Hi-Moybdenum tool steel.
- Gold surface treated body and clearance for maximum lubricity.
- Heavy-duty construction, 135° split point, no center punch needed - will not walk.
- Recommended for work hardening grades of stainless steel and other hard metal drilling applications.



LETTER

Part #	Letter Sizes	Overall Length Inches	Flute Length Inches	Qty. per/pack
23601	A	2-7/16	1-5/16	12
23611	B	2-1/2	1-3/8	12
23621	C	2-1/2	1-3/8	12
23631	D	2-1/2	1-3/8	12
23641	E	2-1/2	1-3/8	12
23651	F	2-5/8	1-7/16	12
23661	G	2-5/8	1-7/16	12
23671	H	2-11/16	1-1/2	12
23681	I	2-11/16	1-1/2	12
23691	J	2-11/16	1-1/2	12
23701	K	2-11/16	1-1/2	12
23711	L	2-3/4	1-9/16	12
23721	M	2-3/4	1-9/16	6
23731	N	2-13/16	1-5/8	6
23741	O	2-15/16	1-11/16	6
23751	P	2-15/16	1-11/16	6
23761	Q	3	1-11/16	6
23771	R	3	1-11/16	6
23781	S	3-1/16	1-3/4	6
23791	T	3-1/16	1-3/4	6
23801	U	3-1/8	1-13/16	6
23811	V	3-1/4	1-7/8	6
23821	W	3-1/4	1-7/8	6
23831	X	3-5/16	1-15/16	6
23841	Y	3-5/16	1-15/16	6
23851	Z	3-3/8	2	6

Type 260-QT

1/4" Reduced Shank - Heavy-Duty Surfaced
Treated, 135° Split Point

- This HSS drill is recommended for "punch" rilling in hard, tough sheet metal applications where quick and accurately located holes are required.



TYPE 260-QT 1/4" REDUCED SHANK

Part #	Diameter Inches	Overall Length Inches	Flute Length Inches	Qty. per/pack
22410	17/64	2-5/8	1-7/16	12
22420	9/32	2-11/16	1-1/2	12
22430	19/64	2-3/4	1-9/16	6
22440	5/16	2-13/16	1-5/8	6
22450	21/64	2-15/16	1-11/16	6
22460	11/32	3	1-11/16	6
22470	23/64	3-1/16	1-3/4	6
22480	3/8	3-1/8	1-13/16	6
22490	25/64	3-1/4	1-7/8	6
22500	13/32	3-5/16	1-15/16	6
22510	27/64	3-3/8	2	6
22520	7/16	3-7/16	2-1/16	6
22530	29/64	3-9/16	2-1/8	6
22540	15/32	3-5/8	2-1/8	6
22550	31/64	3-11/16	2-3/16	6
22560	1/2	3-3/4	2-1/4	6



Product Tips

NEED A TAPPING LUBE?

High Performance Ultra S/P™
will do the job!

Found on page 98

Screw Machine Length

TITANIUM NITRIDE, BRIGHT FINISHED NAS 907C HEAVY-DUTY



Type 260-T
Sturdy drill for use in portable power drilling.



Type 260-TW
Bright finish accurate centering, fast penetration.



Type 260-TN
TiN coating provides a super hard surface with high lubricity.

NOTE: * TiN Coated Package Quantity
(6 qty. - 1/16 thru 9/32 A-L #1 - 60) (3 qty. - 19/64 - 1/2")

FRACTIONAL

Type 260-T Part #	Type *260-TN Part #	Type 260-TW Part #	Diameter Inches	Overall Length Inches	Flute Length Inches	Qty. per/pack
25560	97600	52240	1/16	1-5/8	5/8	12
25570	97590	52250	5/64	1-11/16	11/16	12
25580	97580	52260	3/32	1-3/4	3/4	12
25590	97570	52270	7/64	1-13/16	13/16	12
25600	97560	52280	1/8	1-7/8	7/8	12
25610	97550	52290	9/64	1-15/16	15/16	12
25620	97540	52300	5/32	2-1/16	1	12
25630	97530	52310	11/64	2-1/8	1-1/16	12
25640	97520	52320	3/16	2-3/16	1-1/8	12
06190	97510	52330	13/64	2-1/4	1-3/16	12
06200	97500	52340	7/32	2-3/8	1-1/4	12
06210	97490	52350	15/64	2-7/16	1-5/16	12
06220	97480	52360	1/4	2-1/2	1-3/8	12
06230	97470	52370	17/64	2-5/8	1-7/16	12
06240	97460	52380	9/32	2-11/16	1-1/2	12
06250	97450	52390	19/64	2-3/4	1-9/16	6
06260	97440	52400	5/16	2-13/16	1-5/8	6
06270	97430	52410	21/64	2-15/16	1-11/16	6
06280	97420	52420	11/32	3	1-11/16	6
06290	97410	52430	23/64	3-1/16	1-3/4	6
06300	97400	52440	3/8	3-1/8	1-13/16	6
06310	97390	52450	25/64	3-1/4	1-7/8	6
06320	97380	52460	13/32	3-5/16	1-15/16	6
06330	97370	52470	27/64	3-3/8	2	6
06340	97360	52480	7/16	3-7/16	2-1/16	6
06350	97350	52490	29/64	3-9/16	2-1/8	6
06360	97340	52500	15/32	3-5/8	2-1/8	6
06370	97330	52510	31/64	3-11/16	2-3/16	6
06380	97320	52520	1/2	3-3/4	2-1/4	6

For Letter Sizes use Type 260-UB page 35

NOTE: * TiN Coated Package Quantity
(6 qty. - 1/16 thru 9/32 A-L #1 - 60) (3 qty. - 19/64 - 1/2")

WIRE

Type 260-T Part #	Type *260-TN Part #	Type 260-TW Part #	Wire Sizes	Overall Length Inches	Flute Length Inches	Qty. per/pack
25850	96670	52530	1	2-7/16	1-5/16	12
25860	96660	52540	2	2-7/16	1-5/16	12
25870	96650	52550	3	2-3/8	1-1/4	12
25880	96640	52560	4	2-3/8	1-1/4	12
25890	96630	52570	5	2-3/8	1-1/4	12
25900	96620	52580	6	2-3/8	1-1/4	12
25910	96610	52590	7	2-1/4	1-3/16	12
25920	96600	52600	8	2-1/4	1-3/16	12
25930	96590	52610	9	2-1/4	1-3/16	12

Type 260-T, Type 260-TN, Type 260-TW NAS 907C Heavy-Duty 135° Split Point

- A sturdy drill for use in portable power drilling.
- Accurate centering, fast penetration. Ideal for thin metal work.
- Sizes smaller than #52 are not split pointed.

NOTE: For letter sizes, see 260-UB page 36

NOTE: * TiN Coated Package Quantity
(6 qty. - 1/16 thru 9/32 A-L #1 - 60) (3 qty. - 19/64 - 1/2")

WIRE - CONTINUED

Type 260-T Part #	Type *260-TN Part #	Type 260-TW Part #	Wire Sizes	Overall Length Inches	Flute Length Inches	Qty. per/pack
25940	96580	52620	10	2-1/4	1-3/16	12
25960	96570	52630	11	2-1/4	1-3/16	12
25970	96560	52640	12	2-1/4	1-3/16	12
25980	96550	52650	13	2-3/16	1-1/8	12
25990	96540	52660	14	2-3/16	1-1/8	12
26000	96530	52670	15	2-3/16	1-1/8	12
26010	96520	52680	16	2-3/16	1-1/8	12
26020	96510	52690	17	2-3/16	1-1/8	12
26030	96500	52700	18	2-1/8	1-1/16	12
26040	96490	52710	19	2-1/8	1-1/16	12
26050	96480	52720	20	2-1/8	1-1/16	12
26060	96470	52730	21	2-1/8	1-1/16	12
26070	96460	52740	22	2-1/8	1-1/16	12
26080	96450	52750	23	2-1/16	1	12
26090	96440	52760	24	2-1/16	1	12
26100	96430	52770	25	2-1/16	1	12
26110	96420	52780	26	2-1/16	1	12
26120	96410	52790	27	2-1/16	1	12
26130	96400	52800	28	1-15/16	15/16	12
26140	96390	52810	29	1-15/16	15/16	12
26150	96380	52820	30	1-15/16	15/16	12
26160	96370	52830	31	1-7/8	7/8	12
26170	96360	52840	32	1-7/8	7/8	12
26180	96350	52850	33	1-7/8	7/8	12
26190	96340	52860	34	1-7/8	7/8	12
26200	96330	52870	35	1-7/8	7/8	12
26210	96320	52880	36	1-13/16	13/16	12
26220	96310	52890	37	1-13/16	13/16	12
26230	96300	52900	38	1-13/16	13/16	12
26240	96290	52910	39	1-13/16	13/16	12
26250	96280	52920	40	1-13/16	13/16	12
26260	96270	52930	41	1-13/16	13/16	12
26270	96260	52940	42	1-3/4	3/4	12
26280	96250	52950	43	1-3/4	3/4	12
26290	96240	52960	44	1-3/4	3/4	12
26300	96230	52970	45	1-3/4	3/4	12
26310	96220	52980	46	1-3/4	3/4	12
26320	96210	52990	47	1-3/4	3/4	12
26330	96200	53000	48	1-11/16	11/16	12
26340	96190	53010	49	1-11/16	11/16	12
26350	96180	53020	50	1-11/16	11/16	12
26360	96170	53030	51	1-11/16	11/16	12
26370	96160	53040	52	1-11/16	11/16	12
26380	96150	53050	53	1-5/8	5/8	12
26390	96140	53060	54	1-5/8	5/8	12
26400	96130	53070	55	1-5/8	5/8	12
26410	96120	53080	56	1-3/8	1/2	12
26420	96110	53090	57	1-3/8	1/2	12
26430	96100	53100	58	1-3/8	1/2	12
26440	96090	53110	59	1-3/8	1/2	12
26450	96080	53120	60	1-3/8	1/2	12

Screw Machine Length



HSS SCREW MACHINE

Type 260 & Type 260-BN Titanium Nitride
 118° Point - High-Speed Steel - General Purpose,

Bright-Flute thru 3/4" diameter.
 Surface treated flutes over 3/4" diameter.

- Can be used for all screw machine qualified to run in all applications.
- This drill is designed for ease of penetration and to facilitate chip removal in tough, hard materials.
- May also be used in portable drilling equipment. Drill sizes over 1-1/16" have a reduced shank.



Type 260

The short length of drill and flute makes this an especially rigid drill for greater drilling accuracy.



Type 260-BN

Performs well in mild drilling applications with abrasive wear characteristics.

FRACTIONAL

260 Part #	260-BN TiN Coated Part #	Diameter Inches	Overall Length Inches	Flute Length Inches	260 Qty. per/pack	260-BN Qty. per/pack
23860	-----	3/64	1-3/8	1/2	12	-----
23870	01501	1/16	1-5/8	5/8	12	6
23880	01511	5/64	1-11/16	11/16	12	6
23890	01521	3/32	1-3/4	3/4	12	6
23900	01531	7/64	1-13/16	13/16	12	6
23910	01541	1/8	1-7/8	7/8	12	6
23920	01551	9/64	1-15/16	15/16	12	6
23930	01561	5/32	2-1/16	1	12	6
23940	01571	11/64	2-1/8	1-1/16	12	6
23950	01581	3/16	2-3/16	1-1/8	12	6
23960	01591	13/64	2-1/4	1-3/16	12	6
23970	01601	7/32	2-3/8	1-1/4	12	6
23980	01611	15/64	2-7/16	1-5/16	12	6
23990	01621	1/4	2-1/2	1-3/8	12	6
24000	01631	17/64	2-5/8	1-7/16	12	6
24010	01641	9/32	2-11/16	1-1/2	12	6
24020	01651	19/64	2-3/4	1-9/16	6	3
24030	01661	5/16	2-13/16	1-5/8	6	3
24040	01671	21/64	2-15/16	1-11/16	6	3
24050	01681	11/32	3	1-11/16	6	3
24060	01691	23/64	3-1/16	1-3/4	6	3
24070	01701	3/8	3-1/8	1-13/16	6	3
24080	01711	25/64	3-1/4	1-7/8	6	3
24090	01721	13/32	3-5/16	1-15/16	6	3
24100	01731	27/64	3-3/8	2	6	3
24110	01741	7/16	3-7/16	2-1/16	6	3
24120	01751	29/64	3-9/16	2-1/8	6	3
24130	01761	15/32	3-5/8	2-1/8	6	3
24140	01771	31/64	3-11/16	2-3/16	6	3
24150	01781	1/2	3-3/4	2-1/4	6	3
24160	-----	33/64	3-7/8	2-3/8	1	-----
24170	-----	17/32	3-7/8	2-3/8	1	-----
24180	-----	35/64	4	2-1/2	1	-----
24190	-----	9/16	4	2-1/2	1	-----
24200	-----	37/64	4-1/8	2-5/8	1	-----
24210	-----	19/32	4-1/8	2-5/8	1	-----
24220	-----	39/64	4-1/4	2-3/4	1	-----
24230	-----	5/8	4-1/4	2-3/4	1	-----
24240	-----	41/64	4-1/2	2-7/8	1	-----
24250	-----	21/32	4-1/2	2-7/8	1	-----
24260	-----	43/64	4-1/2	2-7/8	1	-----
24270	-----	11/16	4-1/2	2-7/8	1	-----
24280	-----	45/64	4-3/4	3	1	-----
24290	-----	23/32	4-3/4	3	1	-----
24300	-----	47/64	5	3-1/8	1	-----
24310	-----	3/4	5	3-1/8	1	-----
24320	-----	49/64	5-1/8	3-1/4	1	-----
24330	-----	25/32	5-1/8	3-1/4	1	-----

FRACTIONAL

260 Part #	260-BN TiN Coated Part #	Diameter Inches	Overall Length Inches	Flute Length Inches	260 Qty. per/pack	260-BN Qty. per/pack
24340	-----	51/64	5-1/4	3-3/8	1	-----
24350	-----	13/16	5-1/4	3-3/8	1	-----
24360	-----	53/64	5-3/8	3-1/2	1	-----
24370	-----	27/32	5-3/8	3-1/2	1	-----
24380	-----	55/64	5-3/8	3-1/2	1	-----
24390	-----	7/8	5-3/8	3-1/2	1	-----
24400	-----	57/64	5-5/8	3-5/8	1	-----
24410	-----	29/32	5-5/8	3-5/8	1	-----
24420	-----	59/64	5-3/4	3-3/4	1	-----
24430	-----	15/16	5-3/4	3-3/4	1	-----
24440	-----	61/64	5-7/8	3-7/8	1	-----
24450	-----	31/32	5-7/8	3-7/8	1	-----
24460	-----	63/64	6	4	1	-----
24470	-----	1"	6	4	1	-----
24480	-----	1-1/16	6-1/4	4	1	-----
24490	-----	1-1/8	6-3/8	4	1	-----
24500	-----	1-3/16	6-5/8	4-1/4	1	-----
24510	-----	1-1/4	6-3/4	4-3/8	1	-----
24520	-----	1-5/16	7	4-3/8	1	-----
24530	-----	1-3/8	7-1/8	4-1/2	1	-----
24540	-----	1-7/16	7-3/8	4-3/4	1	-----
24550	-----	1-1/2	7-1/2	4-7/8	1	-----
24560	-----	1-9/16	7-3/4	4-7/8	1	-----
24570	-----	1-5/8	7-3/4	4-7/8	1	-----
24580	-----	1-11/16	8	5-1/8	1	-----
24590	-----	1-3/4	8	5-1/8	1	-----
24600	-----	1-13/16	8-1/4	5-3/8	1	-----
24610	-----	1-7/8	8-1/4	5-3/8	1	-----
24620	-----	1-15/16	8-1/2	5-5/8	1	-----
24630	-----	2"	8-1/2	5-5/8	1	-----

Wire, Letter sizes continued on page 39

Drill Size Shank Diameter

1-1/16" to 1-1/4"	1"
1-5/16" to 1-1/2"	1-1/4"
1-9/16" to 2"	1-1/2"

HSS SCREW MACHINE



Type 260

The short length of drill and flute makes this an especially rigid drill for greater drilling accuracy.



Type 260-BN

Performs well in mild drilling applications with abrasive wear characteristics.

Type 260, Type 260-BN Titanium Nitride High-Speed Steel - General Purpose - 118° Point

- The short length of drill and flute makes this an especially rigid drill for greater drilling accuracy.
- May also be used in portable drilling equipment.

WIRE							
260 Part #	260-BN Part #	Wire Sizes	Overall Length Inches	Flute Length Inches	260 Qty. per/pack	260-BN Qty. per/pack	
24640	24643	1	2-7/16	1-5/16	12	6	
24650	24653	2	2-7/16	1-5/16	12	6	
24660	24663	3	2-3/8	1-1/4	12	6	
24670	24673	4	2-3/8	1-1/4	12	6	
24680	24683	5	2-3/8	1-1/4	12	6	
24690	24693	6	2-3/8	1-1/4	12	6	
24700	24703	7	2-1/4	1-3/16	12	6	
24710	24713	8	2-1/4	1-3/16	12	6	
24720	24723	9	2-1/4	1-3/16	12	6	
24730	24733	10	2-1/4	1-3/16	12	6	
24740	24743	11	2-1/4	1-3/16	12	6	
24750	24753	12	2-1/4	1-3/16	12	6	
24760	24763	13	2-3/16	1-1/8	12	6	
24770	24773	14	2-3/16	1-1/8	12	6	
24780	24783	15	2-3/16	1-1/8	12	6	
24790	24793	16	2-3/16	1-1/8	12	6	
24800	24803	17	2-3/16	1-1/8	12	6	
24810	24813	18	2-1/8	1-1/16	12	6	
24820	24823	19	2-1/8	1-1/16	12	6	
24830	24833	20	2-1/8	1-1/16	12	6	
24840	24843	21	2-1/8	1-1/16	12	6	
24850	24853	22	2-1/8	1-1/16	12	6	
24860	24863	23	2-1/16	1	12	6	
24870	24873	24	2-1/16	1	12	6	
24880	24883	25	2-1/16	1	12	6	
24890	24893	26	2-1/16	1	12	6	
24900	24903	27	2-1/16	1	12	6	
24910	24913	28	1-15/16	15/16	12	6	
24920	24923	29	1-15/16	15/16	12	6	
24930	24933	30	1-15/16	15/16	12	6	
24940	24943	31	1-7/8	7/8	12	6	
24950	24953	32	1-7/8	7/8	12	6	
24960	24963	33	1-7/8	7/8	12	6	
24970	24973	34	1-7/8	7/8	12	6	
24980	24983	35	1-7/8	7/8	12	6	
24990	24993	36	1-13/16	13/16	12	6	
25000	25003	37	1-13/16	13/16	12	6	
25010	25013	38	1-13/16	13/16	12	6	
25020	25023	39	1-13/16	13/16	12	6	
25030	25033	40	1-13/16	13/16	12	6	
25040	25043	41	1-13/16	13/16	12	6	
25050	25053	42	1-3/4	3/4	12	6	
25060	25063	43	1-3/4	3/4	12	6	
25070	25073	44	1-3/4	3/4	12	6	
25080	25083	45	1-3/4	3/4	12	6	
25090	25093	46	1-3/4	3/4	12	6	
25100	25103	47	1-3/4	3/4	12	6	
25110	25113	48	1-11/16	11/16	12	6	
25120	25123	49	1-11/16	11/16	12	6	
25130	25133	50	1-11/16	11/16	12	6	
25140	25143	51	1-11/16	11/16	12	6	
25150	25153	52	1-11/16	11/16	12	6	
25160	25163	53	1-5/8	5/8	12	6	
25170	25173	54	1-5/8	5/8	12	6	
25180	25183	55	1-5/8	5/8	12	6	
25190	25193	56	1-3/8	1/2	12	6	
25200	25203	57	1-3/8	1/2	12	6	
25210	25213	58	1-3/8	1/2	12	6	
25220	25223	59	1-3/8	1/2	12	6	
25230	25233	60	1-3/8	1/2	12	6	

LETTER							
260 Part #	260-BN Part #	Letter Sizes	Overall Length Inches	Flute Length Inches	260 Qty. per/pack	260-BN Qty. per/pack	
23600	-----	A	2-7/16	1-5/16	12	-----	
23610	-----	B	2-1/2	1-3/8	12	-----	
23620	-----	C	2-1/2	1-3/8	12	-----	
23630	-----	D	2-1/2	1-3/8	12	-----	
23640	-----	E	2-1/2	1-3/8	12	-----	
23650	-----	F	2-5/8	1-7/16	12	-----	
23660	-----	G	2-5/8	1-7/16	12	-----	
23670	-----	H	2-11/16	1-1/2	12	-----	
23680	-----	I	2-11/16	1-1/2	12	-----	
23690	-----	J	2-11/16	1-1/2	12	-----	
23700	-----	K	2-11/16	1-1/2	12	-----	
23710	-----	L	2-3/4	1-9/16	12	-----	
23720	-----	M	2-3/4	1-9/16	6	-----	
23730	-----	N	2-13/16	1-5/8	6	-----	
23740	-----	O	2-15/16	1-11/16	6	-----	
23750	-----	P	2-15/16	1-11/16	6	-----	
23760	-----	Q	3	1-11/16	6	-----	
23770	-----	R	3	1-11/16	6	-----	
23780	-----	S	3-1/16	1-3/4	6	-----	
23790	-----	T	3-1/16	1-3/4	6	-----	
23800	-----	U	3-1/8	1-13/16	6	-----	
23810	-----	V	3-1/4	1-7/8	6	-----	
23820	-----	W	3-1/4	1-7/8	6	-----	
23830	-----	X	3-5/16	1-15/16	6	-----	
23840	-----	Y	3-5/16	1-15/16	6	-----	
23850	-----	Z	3-3/8	2	6	-----	

HSS TAPER LENGTH

Type 210

High-Speed Steel 118° Point



- Bright finish to 1" diameter.
- General purpose 118° point, recommended for mild drilling applications where longer than jobber length drills are required.
- Surface treated flutes from 1-1/64" to 1-3/4" diameter.

FRACTIONAL

Part #	Diameter Inches	Overall Length Inches	Flute Length Inches	Qty. per/pack
10490	3/64	2-1/4	1-1/8	12
10500	1/16	3	1-3/4	12
10510	5/64	3-3/4	2	12
10520	3/32	4-1/4	2-1/4	12
10530	7/64	4-5/8	2-1/2	12
10540	1/8	5-1/8	2-3/4	12
10550	9/64	5-3/8	3	12
10560	5/32	5-3/8	3	12
10570	11/64	5-3/4	3-3/8	12
10580	3/16	5-3/4	3-3/8	12
10590	13/64	6	3-5/8	12
10600	7/32	6	3-5/8	12
10610	15/64	6-1/8	3-3/4	12
10620	1/4	6-1/8	3-3/4	12
10630	17/64	6-1/4	3-7/8	12
10640	9/32	6-1/4	3-7/8	12
10650	19/64	6-3/8	4	6
10660	5/16	6-3/8	4	6
10670	21/64	6-1/2	4-1/8	6
10680	11/32	6-1/2	4-1/8	6
10690	23/64	6-3/4	4-1/4	6
10700	3/8	6-3/4	4-1/4	6
10710	25/64	7	4-3/8	1
10720	13/32	7	4-3/8	1
10730	27/64	7-1/4	4-5/8	1
10740	7/16	7-1/4	4-5/8	1
10750	29/64	7-1/2	4-3/4	1
10760	15/32	7-1/2	4-3/4	1
10770	31/64	7-3/4	4-3/4	1
10780	1/2	7-3/4	4-3/4	1
10790	33/64	8	4-3/4	1
10800	17/32	8	4-3/4	1
10810	35/64	8-1/4	4-7/8	1
10820	9/16	8-1/4	4-7/8	1
10830	37/64	8-3/4	4-7/8	1
10840	19/32	8-3/4	4-7/8	1
10850	39/64	8-3/4	4-7/8	1
10860	5/8	8-3/4	4-7/8	1
10870	41/64	9	5-1/8	1
10880	21/32	9	5-1/8	1
10890	43/64	9-1/4	5-3/8	1
10900	11/16	9-1/4	5-3/8	1
10910	45/64	9-1/2	5-5/8	1
10920	23/32	9-1/2	5-5/8	1
10930	47/64	9-3/4	5-7/8	1
10940	3/4	9-3/4	5-7/8	1
10950	49/64	9-7/8	6	1
10960	25/32	9-7/8	6	1
10970	51/64	10	6-1/8	1
10980	13/16	10	6-1/8	1
10990	53/64	10	6-1/8	1
11000	27/32	10	6-1/8	1
11010	55/64	10	6-1/8	1
11020	7/8	10	6-1/8	1
11030	57/64	10	6-1/8	1
11040	29/32	10	6-1/8	1
11050	59/64	10-3/4	6-1/8	1

FRACTIONAL

Part #	Diameter Inches	Overall Length Inches	Flute Length Inches	Qty. per/pack
11060	15/16	10-3/4	6-1/8	1
11070	61/64	11	6-3/8	1
11080	31/32	11	6-3/8	1
11090	63/64	11	6-3/8	1
11100	1"	11	6-3/8	1
11110	1-1/64	11-1/8	6-1/2	1
11120	1-1/32	11-1/8	6-1/2	1
11130	1-3/64	11-1/4	6-5/8	1
11140	1-1/16	11-1/4	6-5/8	1
11150	1-5/64	11-1/2	6-7/8	1
11160	1-3/32	11-1/2	6-7/8	1
11170	1-7/64	11-3/4	7-1/8	1
11180	1-1/8	11-3/4	7-1/8	1
11190	1-9/64	11-7/8	7-1/4	1
11200	1-5/32	11-7/8	7-1/4	1
11210	1-11/64	12	7-3/8	1
11220	1-3/16	12	7-3/8	1
11230	1-13/64	12-1/8	7-1/2	1
11240	1-7/32	12-1/8	7-1/2	1
11250	1-15/64	12-1/2	7-7/8	1
11260	1-1/4	12-1/2	7-7/8	1
11270	1-9/32	14-1/8	8-1/2	1
11280	1-5/16	14-1/4	8-5/8	1
11290	1-11/32	14-3/8	8-3/4	1
11300	1-3/8	14-1/2	8-7/8	1
11310	1-13/32	14-5/8	9	1
11320	1-7/16	14-3/4	9-1/8	1
11330	1-15/32	14-7/8	9-1/4	1
11340	1-1/2	15	9-3/8	1
11350	1-9/16	15-1/4	9-5/8	1
11360	1-5/8	15-5/8	9-7/8	1
11370	1-3/4	16-1/4	10-1/2	1

WIRE

Part #	Wire Sizes	Overall Length Inches	Flute Length Inches	Qty. per/pack
11640	1	6-1/8	3-3/4	12
11650	2	6-1/8	3-3/4	12
11660	3	6	3-5/8	12
11670	4	6	3-5/8	12
11680	5	6	3-5/8	12
11690	6	6	3-5/8	12
11700	7	6	3-5/8	12
11710	8	6	3-5/8	12
11720	9	6	3-5/8	12
11730	10	6	3-5/8	12
11740	11	6	3-5/8	12
11750	12	6	3-5/8	12
11760	13	5-3/4	3-3/8	12
11770	14	5-3/4	3-3/8	12
11780	15	5-3/4	3-3/8	12
11790	16	5-3/4	3-3/8	12
11800	17	5-3/4	3-3/8	12
11810	18	5-3/4	3-3/8	12
11820	19	5-3/4	3-3/8	12

Wire & Letter sizes continued on page 41

Taper Length

HSS TAPER LENGTH & AUTOMOTIVE TANG DRIVE

Type 210 - High-Speed Steel 118° Point

WIRE

Part #	Wire Sizes	Overall Length Inches	Flute Length Inches	Qty. per/pack
11830	20	5-3/4	3-3/8	12
11840	21	5-3/4	3-3/8	12
11850	22	5-3/4	3-3/8	12
11860	23	5-3/8	3	12
11870	24	5-3/8	3	12
11880	25	5-3/8	3	12
11890	26	5-3/8	3	12
11900	27	5-3/8	3	12
11910	28	5-3/8	3	12
11920	29	5-3/8	3	12
11930	30	5-3/8	3	12
11940	31	5-1/8	2-3/4	12
11950	32	5-1/8	2-3/4	12
11960	33	5-1/8	2-3/4	12
11970	34	5-1/8	2-3/4	12
11980	35	5-1/8	2-3/4	12
11990	36	4-5/8	2-1/2	12
12000	37	4-5/8	2-1/2	12
12010	38	4-5/8	2-1/2	12
12020	39	4-5/8	2-1/2	12
12030	40	4-5/8	2-1/2	12
12040	41	4-5/8	2-1/2	12
12050	42	4-1/4	2-1/4	12
12060	43	4-1/4	2-1/4	12
12070	44	4-1/4	2-1/4	12
12080	45	4-1/4	2-1/4	12
12090	46	4-1/4	2-1/4	12
12100	47	4-1/4	2-1/4	12
12110	48	3-3/4	2	12
12120	49	3-3/4	2	12
12130	50	3-3/4	2	12
12140	51	3-3/4	2	12
12150	52	3-3/4	2	12
12160	53	3	1-3/4	12
12170	54	3	1-3/4	12
12180	55	3	1-3/4	12
12190	56	2-1/4	1-1/8	12
12200	57	2-1/4	1-1/8	12
12210	58	2-1/4	1-1/8	12
12220	59	2-1/4	1-1/8	12
12230	60	2-1/4	1-1/8	12

LETTER

Part #	Letter Sizes	Overall Length Inches	Flute Length Inches	Qty. per/pack
11380	A	6-1/8	3-3/4	12
11390	B	6-1/8	3-3/4	12
11400	C	6-1/8	3-3/4	12
11410	D	6-1/8	3-3/4	12
11420	E	6-1/8	3-3/4	12
11430	F	6-1/4	3-7/8	12
11440	G	6-1/4	3-7/8	12
11450	H	6-1/4	3-7/8	12
11460	I	6-1/4	3-7/8	12
11470	J	6-1/4	3-7/8	12
11480	K	6-1/4	3-7/8	12
11490	L	6-3/8	4	12
11500	M	6-3/8	4	6
11510	N	6-3/8	4	6
11520	O	6-1/2	4-1/8	6
11530	P	6-1/2	4-1/8	6
11540	Q	6-1/2	4-1/8	6
11550	R	6-1/2	4-1/8	6
11560	S	6-3/4	4-1/4	6
11570	T	6-3/4	4-1/4	6
11580	U	6-3/4	4-1/4	6
11590	V	7	4-3/8	1
11600	W	7	4-3/8	1
11610	X	7	4-3/8	1
11620	Y	7	4-3/8	1
11630	Z	7-1/4	4-5/8	1

Type 220

Automotive Series - Tang Drive

High-Speed Steel - General Purpose, 118° Point

- Tanged and surface treated. When used with A.S.A. split sleeve drill drivers, these drills serve as economical substitutes for taper shank drills.



FRACTIONAL

Part #	Diameter Inches	Overall Length Inches	Flute Length Inches	Qty. per/pack
12870	1/8	5-1/8	2-3/4	12
12880	9/64	5-3/8	3	12
12890	5/32	5-3/8	3	12
12900	11/64	5-3/4	3-3/8	12
12910	3/16	5-3/4	3-3/8	12
12920	13/64	6	3-5/8	12
12930	7/32	6	3-5/8	12
12940	15/64	6-1/8	3-3/4	12
12950	1/4	6-1/8	3-3/4	12
12960	17/64	6-1/4	3-7/8	12
12970	9/32	6-1/4	3-7/8	12
12980	19/64	6-3/8	4	6
12990	5/16	6-3/8	4	6
13000	21/64	6-1/2	4-1/8	6
13010	11/32	6-1/2	4-1/8	6
13020	23/64	6-3/4	4-1/4	6
13030	3/8	6-3/4	4-1/4	6
13040	25/64	7	4-3/8	1
13050	13/32	7	4-3/8	1
13060	27/64	7-1/4	4-5/8	1
13070	7/16	7-1/4	4-5/8	1
13080	29/64	7-1/2	4-3/4	1
13090	15/32	7-1/2	4-3/4	1
13100	31/64	7-3/4	4-3/4	1
13110	1/2	7-3/4	4-3/4	1
13120	33/64	8	4-3/4	1
13130	17/32	8	4-3/4	1
13140	35/64	8-1/4	4-7/8	1
13150	9/16	8-1/4	4-7/8	1
13160	37/64	8-3/4	4-7/8	1
13170	19/32	8-3/4	4-7/8	1
13180	39/64	8-3/4	4-7/8	1
13190	5/8	8-3/4	4-7/8	1
13200	41/64	9	5-1/8	1
13240	21/32	9	5-1/8	1
13220	43/64	9-1/4	5-3/8	1
13230	11/16	9-1/4	5-3/8	1
72530	47/64	9-3/4	5-7/8	1
72540	3/4	9-3/4	5-7/8	1

HEAVY DUTY PARABOLIC

Type 221-PT

Heavy-Duty - Parabolic Flute -Taper Length
Titanium Nitride - Tang Drive 135° Split Point

- This high performance drill combines the superior wear resistance of Titanium Nitride coating, and the deep hole drilling advantages of parabolic flutes.
- The exceptional qualities of these drills can provide high productivity and extended tool life when compared to uncoated high-speed steel.



FRACTIONAL

Part #	Diameter Inches	Overall Length Inches	Flute Length Inches	Qty. per/pack
34600	1/8	5-1/8	3-3/8	6
34610	9/64	5-3/8	3-5/8	6
34620	5/32	5-3/8	3-3-4	6
34630	11/64	5-3/4	4-1/8	6
34640	3/16	5-3/4	4-1/8	6
34650	13/64	6	4-3/8	6
34660	7/32	6	4-3/8	6
34670	15/64	6-1/8	4-13/16	6
34680	1/4	6-1/8	4-13/16	6
34690	17/64	6-1/4	5	6
34700	9/32	6-1/4	5-	6
34710	19/64	6-3/8	5-1/8	3
34720	5/16	6-3/8	5-1/8	3
34730	21/64	6-1/2	5-1/4	3
34740	11/32	6-1/2	5-1/4	3
34750	23/64	6-3/4	5-3/8	3
34760	3/8	6-3/4	5-3/8	3
34770	25/64	7	5-5/8	1
34780	13/32	7	5-5/8	1
34790	27/64	7-1/4	5-11/16	1
34800	7/16	7-1/4	5-11/16	1
34810	29/64	7-1/2	5-3/4	1
34820	15/32	7-1/2	5-3/4	1
34830	31/64	7-3/4	5-3/4	1
34840	1/2	7-3/4	5-3/4	1

Type 221-P

Heavy-Duty - Parabolic Flute Taper Length
135° Split Point - Tang Drive - Black Oxide

- Parabolic flute drills are designed to eliminate the need for frequent drill retraction when deep hole drilling in low to medium tensile strength materials.
- The split point and heavy-duty design provide superior performance by permitting higher feed rates and continuous drilling of deep holes.



FRACTIONAL

Part #	Diameter Inches	Overall Length Inches	Flute Length Inches	Qty. per/pack
35320	1/8	5-1/8	3-3/8	12
35330	9/64	5-3/8	3-5/8	12
35340	5/32	5-3/8	3-3-4	12
35350	11/64	5-3/4	4-1/8	12
35360	3/16	5-3/4	4-1/8	12
35370	13/64	6	4-3/8	12
35380	7/32	6	4-3/8	12
35390	15/64	6-1/8	4-13/16	12
35400	1/4	6-1/8	4-13/16	12
35410	17/64	6-1/4	5	12
35420	9/32	6-1/4	5	12
35430	19/64	6-3/8	5-1/8	6
35440	5/16	6-3/8	5-1/8	6
35450	21/64	6-1/2	5-1/4	6
35460	11/32	6-1/2	5-1/4	6
35470	23/64	6-3/4	5-3/8	6
35480	3/8	6-3/4	5-3/8	6
35490	25/64	7	5-5/8	1
35500	13/32	7	5-5/8	1
35510	27/64	7-1/4	5-11/16	1
35520	7/16	7-1/4	5-11/16	1
35530	29/64	7-1/2	5-3/4	1
35540	15/32	7-1/2	5-3/4	1
35550	31/64	7-3/4	5-3/4	1
35560	1/2	7-3/4	5-3/4	1

EXTRA LENGTH DRILLS & LONGBOY DRILLS

Type XGT-UB

Heavy Duty 135° Split Point - 6" - 9" - 12"

- Gyroidal Torsion flute and wide land construction yield exceptional performance in deep hole drilling applications.
- Recommended for work hardening grades of stainless steel and other hard metal drilling operations.
- Will drill 12 or more diameters deep without drill removal to clear chips. Feed rates may be twice that of standard drills.



FRACTIONAL

Part #	Size	Overall Length Inches	Flute Length Inches	Qty. per/pack
39240	1/8x6	6	4	3
39250	#29x6	6	4	3
39260	9/64x6	6	4	3
39270	5/32x6	6	4	3
39280	11/64x6	6	4	3
39300	3/16x6	6	4	3
39310	#10x6	6	4	3
39320	13/64x6	6	4	3
39330	7/32x6	6	4	3
39340	#1x6	6	4	3
39350	15/64x6	6	4	3
39360	1/4x6	6	4	3
39370	"F"x6	6	4	3
39380	9/32x6	6	4	3
39390	5/16x6	6	4	3
39400	11/32x6	6	4	3
39410	3/8x6	6	4	1
39420	13/32x6	6	4	1
39430	7/16x6	6	4	1
39440	1/2x6	6	4	1
40780	1/8x9	9	6	1
40890	9/64	9	6	1
40790	5/32x9	9	6	1
53140	11/64	9	6	1
40800	3/16x9	9	6	1
53160	13/64	9	6	1
40810	7/32x9	9	6	1
53180	15/64	9	6	1
40820	1/4x9	9	6	1
40830	9/32x9	9	6	1
40840	5/16x9	9	6	1
40850	11/32x9	9	6	1
40860	3/8x9	9	6	1
40870	7/16x9	9	6	1
40880	1/2x9	9	6	1
43050	1/8x12	12	9	1
53130	9/64	12	9	1
43060	5/32x12	12	9	1
53150	11/64	12	9	1
43070	3/16x12	12	9	1
53170	13/64	12	9	1
43080	7/32x12	12	9	1
53190	15/64	12	9	1
43090	1/4x12	12	9	1
43100	9/32x12	12	9	1
43110	5/16x12	12	9	1
43120	11/32x12	12	9	1
43130	3/8x12	12	9	1
43140	7/16x12	12	9	1
43150	1/2x12	12	9	1

Type 200 & 208

Longboy Drills Bright Finish - 12" & 18"

- General purpose 118° point high-speed steel drill recommended for a wide range of deep hole drilling applications.



TYPE 200 12" LONGBOY

Part #	Diameter Inches	Overall Length Inches	Flute Length Inches	Qty. per/pack
27200	1/8	12	9	1
27210	9/64	12	9	1
27220	5/32	12	9	1
27230	11/64	12	9	1
27240	3/16	12	9	1
27250	13/64	12	9	1
27260	7/32	12	9	1
27270	15/64	12	9	1
27280	1/4	12	9	1
27290	17/64	12	9	1
27300	9/32	12	9	1
27310	19/64	12	9	1
27320	5/16	12	9	1
27330	21/64	12	9	1
27340	11/32	12	9	1
27350	23/64	12	9	1
27360	3/8	12	9	1
27370	25/64	12	9	1
27380	13/32	12	9	1
27390	27/64	12	9	1
27400	7/16	12	9	1
27410	29/64	12	9	1
27420	15/32	12	9	1
27430	31/64	12	9	1
27440	1/2	12	9	1
27450	17/32	12	9	1
27460	9/16	12	9	1
27470	19/32	12	9	1
27480	5/8	12	9	1
27490	11/16	12	9	1
27500	3/4	12	9	1

TYPE 208 18" LONGBOY

Part #	Diameter Inches	Overall Length Inches	Flute Length Inches	Qty. per/pack
27600	3/16	18	10	1
27610	7/32	18	10	1
27620	1/4	18	12	1
27630	9/32	18	12	1
27640	5/16	18	12	1
27650	11/32	18	12	1
27660	3/8	18	12	1
27670	13/32	18	12	1
27680	7/16	18	12	1
27690	15/32	18	12	1
27700	1/2	18	12	1
27710	17/32	18	12	1
27720	9/16	18	12	1
27730	19/32	18	12	1
27740	5/8	18	12	1

6" & 12" AIRCRAFT TYPE NAS 907B & NAS 907J EXTENSION DRILLS

Heavy-duty 135° split point high-speed steel drill used for drilling holes in hard to reach places.

Type 211 - NAS 907B

6" HSS Aircraft, 135° Split Point
Solid Construction, Black Oxide

Type 209-D - NAS 907J

6" M42 Cobalt, 135° Split Point
Solid Construction



Type 211 - NAS 907B

The black oxide treatment prevents chip welding and increases abrasion resistance.



Type 209-D - NAS 907J

M42 Cobalt steel increases heat and abrasion resistance.

Type 212

12" HSS Aircraft, 135° Split Point
Black Oxide

Type 213-D - NAS 907J

12" M42 Cobalt, 135° Split Point
Solid Construction



Type 212 - NAS 907B

The black oxide treatment prevents chip welding and increases abrasion resistance.



Type 213-D - NAS 907J

M42 Cobalt steel increases heat and abrasion resistance.

6" and 12" Aircraft - Type NAS 907B / NAS 907J

211 Black Oxide Part #	209-D Cobalt Part #	Diameter Inches	Overall Length Inches	Flute Length Inches	Qty. per/pack
68170	----	1/16	6	7/8	6
68180	----	5/64	6	1	6
68470	65090	3/32	6	1-1/4	6
68490	65100	7/64	6	1-1/2	6
68500	65110	1/8	6	1-5/8	6
68510	65120	9/64	6	1-3/4	6
68520	65130	5/32	6	2	6
68530	65140	11/64	6	2-1/8	6
68540	65150	3/16	6	2-5/16	6
68550	65160	13/64	6	2-7/16	6
68560	65170	7/32	6	2-1/2	6
68570	65180	15/64	6	2-5/8	6
68580	65190	1/4	6	2-3/4	6
68190	----	9/32	6	2-15/16	6
68200	----	11/32	6	3-7/16	6
68450	----	21/64	6	3-5/16	6
68760	----	5/16	6	3-3/16	6
68770	----	3/8	6	3-5/8	6
68780	----	7/16	6	4-1/16	6
68790	----	1/2	6	4-1/2	6

WIRE

211 Black Oxide Part #	209-D Cobalt Part #	Wire Sizes	Overall Length Inches	Flute Length Inches	Qty. per/pack
68590	65200	1	6	2-5/8	6
37400	65210	2	6	2-5/8	6
68330	----	5	6	2-1/2	6
68600	65220	10	6	2-7/16	6
68610	65230	11	6	2-5/16	6
68350	----	19	6	2-1/8	6
68620	65240	20	6	2-1/8	6
68630	65250	21	6	2-1/8	6
68370	----	25	6	1-7/8	6
68640	65260	29	6	1-3/4	6
68650	65270	30	6	1-5/8	6
37490	65280	40	6	1-3/8	6

212 Black Oxide Part #	213-D Cobalt Part #	Diameter Inches	Overall Length Inches	Flute Length Inches	Qty. per/pack
02710	----	1/16	12	7/8	1
02740	61800	7/64	12	1-1/2	1
68800	61810	1/8	12	1-5/8	1
68810	61820	9/64	12	1-3/4	1
68820	61830	5/32	12	2	1
68830	61840	11/64	12	2-1/8	1
68840	61850	3/16	12	2-5/16	1
68850	61860	13/64	12	2-7/16	1
68860	61870	7/32	12	2-1/2	1
68870	61880	15/64	12	2-5/8	1
68880	61890	1/4	12	2-3/4	1
68890	----	17/64	12	2-7/8	1
68900	----	9/32	12	2-15/16	1
68910	----	19/64	12	3-1/16	1
68920	----	5/16	12	3-3/16	1
68930	----	21/64	12	3-5/16	1
68940	----	11/32	12	3-7/16	1
68950	----	23/64	12	3-1/2	1
68960	----	3/8	12	3-5/8	1
68970	----	25/64	12	3-3/4	1
68980	----	13/32	12	3-7/8	1
68990	----	27/64	12	3-15/16	1
69000	----	7/16	12	4-1/16	1
69010	----	29/64	12	4-3/16	1
69020	----	15/32	12	4-5/16	1
69030	----	31/64	12	4-3/8	1
69040	----	1/2	12	4-1/2	1

WIRE

212 Black Oxide Part #	213-D Cobalt Part#	Wire Sizes	Overall Length Inches	Flute Length Inches	Qty. per/pack
69050	61900	1	12	2-5/8	1
----	61910	2	12	2-5/8	1
02400	----	5	12	2-5/8	1
69060	61920	10	12	2-7/16	1
69070	61930	11	12	2-5/16	1
69080	61940	20	12	2-1/8	1
69090	61950	21	12	2-1/8	1
69100	61960	29	12	1-3/4	1
69110	61970	30	12	1-5/8	1
02370	61980	40	12	1-3/8	1

SILVER & DEMING - 1/2" REDUCED SHANK

Type 280-UB

1/2" Reduced Shank Ultra Bor Super Premium 3-Flats on Shank Heavy-Duty, 135° Split Point

- Special Hi-Molybdenum tool steel.
- One piece solid construction
- Recommended for use in work hardening grades of stainless steel and other hard metal drilling applications.
- Body and clearance are gold surface treated for maximum lubricity.



FRACTIONAL

Part #	Diameter Inches	Overall Length Inches	Qty. per/pack
29550	33/64	6	1
29560	17/32	6	1
29570	35/64	6	1
29580	9/16	6	1
29590	37/64	6	1
29600	19/32	6	1
29610	39/64	6	1
29620	5/8"	6	1
29630	41/64	6	1
29640	21/32	6	1
29650	43/64	6	1
29660	11/16	6	1
29670	45/64	6	1
29680	23/32	6	1
29690	47/64	6	1
29700	3/4"	6	1
29710	49/64	6	1
29720	25/32	6	1
29730	51/64	6	1
29740	13/16	6	1
29750	53/64	6	1
29760	27/32	6	1
29770	55/64	6	1
29780	7/8"	6	1
29790	57/64	6	1
29800	29/32	6	1
29810	59/64	6	1
29820	15/16	6	1
29830	61/64	6	1
29840	31/32	6	1
29850	63/64	6	1
29860	1"	6	1
29870	1-1/32	6	1
29880	1-1/16	6	1
29890	1-3/32	6	1
29900	1-1/8	6	1
29910	1-5/32	6	1
29920	1-3/16	6	1
29930	1-7/32	6	1
29940	1-1/4	6	1
29950	1-5/16	6	1
29960	1-3/8	6	1
29970	1-7/16	6	1
29980	1-1/2	6	1

Sets - Type 280-UB		4 Pc.
Part #		Qty of each
12250	S&D-4SP 1/2" Shank-Silver & Deming	1

Sets - Type 280-UB		8 Pc.
Part #		Qty of each
92400	S&D-8SP 1/2" Shank - Silver & Deming	1

Type 280-UBX

1/2" Reduced Shank Silver & Deming Premium - 3-Flats on Shank 118° Split Point

- M2 High Speed Steel
- Precision ground point, flutes, body and clearance
- 118° split point for superior general purpose drilling in metal, wood and plastic



FRACTIONAL

Part #	Diameter Inches	Overall Length Inches	Qty. per/pack
74001	33/64	6	1
74011	17/32	6	1
74021	35/64	6	1
74031	9/16"	6	1
74041	37/64	6	1
74051	19/32	6	1
74061	39/64	6	1
74071	5/8"	6	1
74081	41/64	6	1
74091	21/32	6	1
74101	43/64	6	1
74111	11/16	6	1
74121	45/64	6	1
74131	23/32	6	1
74141	47/64	6	1
74151	3/4"	6	1
74161	49/64	6	1
74171	25/32	6	1
74181	51/64	6	1
74191	13/16	6	1
74201	53/64	6	1
74211	27/32	6	1
74221	55/64	6	1
74231	7/8"	6	1
74241	57/64	6	1
74251	29/32	6	1
74261	59/64	6	1
74271	15/16	6	1
74281	61/64	6	1
74291	31/32	6	1
74301	63/64	6	1
74311	1"	6	1
74321	1-1/16	6	1
74331	1-1/8	6	1
74341	1-5/32	6	1
74351	1-3/16	6	1
74361	1-1/4	6	1

Sets - Type 280-UBX		4 Pc.
Part #		Qty of each
74771	S&D-4UBX 1/2" Shank-Silver & Deming	1

Sets - Type 280-UBX		8 Pc.
Part #		Qty of each
74781	S&D-8UBX 1/2" Shank - Silver & Deming	1

Reduced Shank



SILVER & DEMING - 1/2" REDUCED SHANK

Type 280-UBM -METRIC

1/2" Reduced Shank Silver & Deming
135° Split Point Ultra Bor Super Premium,
3-Flats on Shank

- Special Hi-Molybdenum tool steel.
- One piece solid construction
- Sizes greater than 1" 118° split point.
- Body and clearance are gold surface treated for maximum lubricity.
- Recommended for use in work hardening grades of stainless steel and other hard metal drilling applications.



METRIC

Part #	Dia. MM	Overall Length Inches	Part #	Dia. MM	Overall Length Inches
25500	14.0	6	25520	20.0	6
25502	15.0	6	25522	21.0	6
25504	16.0	6	25524	22.0	6
25510	17.0	6	25530	23.0	6
25512	18.0	6	25532	24.0	6
25514	19.0	6	25534	25.0	6

Qty. per package 1 Qty. per package 1

Type 281-UB

3/4" Reduced Shank Silver & Deming
Ultra Bor Super Premium - 135° Split Point

- Tools are designed for drilling with Bridgeport "R8" collect style spindles or other 3/4" collet & 3/4" three jaw chuck styles.
- Precision ground point, body and drill diameter for accuracy and high performance.
- Recommended for use in work hardening grades of stainless steel and other hard metal drilling applications.



FRACTIONAL

Part #	Diameter Inches	Flute Length Inches	Overall Length Inches	Qty. per/pack
29741	13/16	3-1/4	5-1/2	1
29781	7/8	3-1/4	5-1/2	1
29821	15/16	3-1/4	5-1/2	1
29861	1"	3-1/4	5-1/2	1
29901	1-1/8	3-1/2	5-27/32	1
29941	1-1/4	3-1/2	5-7/8	1
29961	1-3/8	3-1/2	5-29/32	1
29981	1-1/2	3-1/2	5-15/16	1

Type 280

1/2" Reduced Shank Silver & Deming
118° point - General Purpose

- This general purpose 118° point high-speed steel drill is recommended for use in drilling equipment with 1/2" chucks.
- Type 280 drills may be used in power applications such as drill presses where a short rigid drill is required.



FRACTIONAL

Part #	Diameter Inches	Overall Length Inches	Qty. per/pack
29130	33/64"	6	1
29140	17/32	6	1
29150	35/64	6	1
29160	9/16	6	1
29170	37/64	6	1
29180	19/32	6	1
29190	39/64	6	1
29200	5/8"	6	1
29210	41/64	6	1
29220	21/32	6	1
29230	43/64	6	1
29240	11/16	6	1
29250	45/64	6	1
29260	23/32	6	1
29270	47/64	6	1
29280	3/4"	6	1
29290	49/64	6	1
29300	25/32	6	1
29310	51/64	6	1
29320	13/16	6	1
29330	53/64	6	1
29340	27/32	6	1
29350	55/64	6	1
29360	7/8"	6	1
29370	57/64	6	1
29380	29/32	6	1
29390	59/64	6	1
29400	15/16	6	1
29410	61/64	6	1
29420	31/32	6	1
29430	63/64	6	1
29440	1"	6	1
29450	1-1/16	6	1
29460	1-1/8	6	1
29470	1-5/32	6	1
29480	1-3/16	6	1
29490	1-1/4	6	1
29540	1-47/64	6	1

SILVER & DEMING - 1/2" REDUCED SHANK

Type 280-MRO

Maintenance Length - 1/2" Reduced Shank
135° Split Point 3-Flats on Shank Surfaced
Treated Flutes

- The 280-MRO is a shorter (5") tougher version of our very popular 1/2" reduced shank product.
- Designed specifically for the needs of the MRO market, the 280-MRO has a 135° split point to insure fast hole starts without drill walking.
- The three flats on the shank insure positive chucking with out slippage.



FRACTIONAL

Part #	Size / Inches	Overall Length	Qty. per/pack
54291	33/64	5	1
54300	17/32	5	1
54301	35/64	5	1
54310	9/16	5	1
54311	37/64	5	1
54320	19/32	5	1
54321	39/64	5	1
54330	5/8"	5	1
54331	41/64	5	1
54340	21/32	5	1
54341	43/64	5	1
54350	11/16	5	1
54351	45/64	5	1
54360	23/32	5	1
54361	47/64	5	1
54370	3/4"	5	1
54371	49/64	5	1
54380	25/32	5	1
54381	51/64	5	1
54390	13/16	5	1
54391	53/64	5	1
54400	27/32	5	1
54401	55/64	5	1
54410	7/8"	5	1
54411	57/64	5	1
54420	29/32	5	1
54421	59/64	5	1
54430	15/16	5	1
54431	61/64	5	1
54440	31/32	5	1
54441	63/64	5	1
54450	1"	5	1

Set - Type 280-MRO

4 Pc.

Part #	9/16, 5/8, 3/4, 1"	Qty of each
54520 S&D-4	1/2" Shank-Silver & Deming	1

Type 280-D

1/2" Reduced Shank Silver & Deming
Super High-Speed - M42 Cobalt

- Heavy-duty 135° split point with gold finish for use in drilling hard tough metals, free machining stainless steel, high temperature alloys, titanium and certain plastics.
- High red hot hardness of cobalt steel permits speeds 30% higher than regular high speed steel drills.
- Cobalt drills require rigidly held, positive feed drilling equipment.



Part #	Diameter Inches	Overall Length Inches	Qty. per/pack
29131	33/64	6	1
29141	17/32	6	1
29151	35/64	6	1
29161	9/16	6	1
29171	37/64	6	1
29181	19/32	6	1
29191	39/64	6	1
29201	5/8	6	1
29211	41/64	6	1
29221	21/32	6	1
29231	43/64	6	1
29241	11/16	6	1
29251	45/64	6	1
29261	23/32	6	1
29271	47/64	6	1
29281	3/4	6	1
29291	49/64	6	1
29331	25/32	6	1
29311	51/64	6	1
29321	13/16	6	1
29301	53/64	6	1
29341	27/32	6	1
29351	55/64	6	1
29361	7/8	6	1
29371	57/64	6	1
29381	29/32	6	1
29391	59/64	6	1
29401	15/16	6	1
29411	61/64	6	1
29421	31/32	6	1
29431	63/64	6	1
29441	1"	6	1

Sets- Type 280-D

4 Pc.

Part #	9/16, 5/8, 3/4, 1"	Qty of each
29551 S&D-4D	M42 Cobalt 135° Split point	1

8 Pc.

Part #	9/16 - 1" by 16ths	Qty of each
29571 S&D-8D	M42 Cobalt 135° Split point	1

Type EXT

Silver and Deming - Extension

Includes an "Allen Wrench"



Part #	Bore/Shank Diameter	Overall Length	Extension Length	Qty. per/pack
62730	1/2" 7/8"	7-1/2"	6 in.	1

Silver & Deming - 1/2" Reduced Shank Cobalt / Maintenance Length

HSS TAPER SHANK - STANDARD

Type 510

High-Speed Steel 118° Point Taper Shank
Regular Shank - Black Oxide Flutes & Clearance

- Taper shank drills are made to fit tapered holders.
- Precision ground flutes, clearance and point.
- Designed to perform well under a wide variety of conditions in a wide range of materials.
- Made in the U.S.A.



FRACTIONAL

Part #	Diameter Inches	Decimal Equivalent Inches	Taper Shank	Overall Length Inches	Flute Length Inches
14150	1/8	.1250	1	5-1/8	1-7/8
14160	9/64	.1406	1	5-3/8	2-1/8
14170	5/32	.1562	1	5-3/8	2-1/8
14180	11/64	.1719	1	5-3/4	2-1/2
14190	3/16	.1875	1	5-3/4	2-1/2
14200	13/64	.2031	1	6	2-3/4
14210	7/32	.2188	1	6	2-3/4
14220	15/64	.2344	1	6-1/8	2-7/8
14230	1/4	.2500	1	6-1/8	2-7/8
14240	17/64	.2656	1	6-1/4	3
14250	9/32	.2812	1	6-1/4	3
14260	19/64	.2969	1	6-3/8	3-1/8
14270	5/16	.3125	1	6-3/8	3-1/8
14280	21/64	.3281	1	6-1/2	3-1/4
14290	11/32	.3438	1	6-1/2	3-1/4
14300	23/64	.3594	1	6-3/4	3-1/2
14310	3/8	.3750	1	6-3/4	3-1/2
14320	25/64	.3906	1	7	3-5/8
14330	13/32	.4062	1	7	3-5/8
14340	27/64	.4219	1	7-1/4	3-7/8
14350	7/16	.4375	1	7-1/4	3-7/8
14360	29/64	.4531	1	7-1/2	4-1/8
14370	15/32	.4688	1	7-1/2	4-1/8
14380	31/64	.4844	2	8-1/4	4-3/8
14390	1/2	.5000	2	8-1/4	4-3/8
14400	33/64	.5156	2	8-1/2	4-5/8
14410	17/32	.5312	2	8-1/2	4-5/8
14420	35/64	.5469	2	8-3/4	4-7/8
14430	9/16	.5625	2	8-3/4	4-7/8
14440	37/64	.5781	2	8-3/4	4-7/8
14450	19/32	.5938	2	8-3/4	4-7/8
14460	39/64	.6094	2	8-3/4	4-7/8
14470	5/8	.6250	2	8-3/4	4-7/8
14480	41/64	.6406	2	9	5-1/8
14490	21/32	.6562	2	9	5-1/8
14500	43/64	.6719	2	9-1/4	5-3/8
14510	11/16	.6875	2	9-1/4	5-3/8
14520	45/64	.7031	2	9-1/2	5-5/8
14530	23/32	.7188	2	9-1/2	5-5/8
14540	47/64	.7344	2	9-3/4	5-7/8
14550	3/4	.7500	2	9-3/4	5-7/8
14560	49/64	.7656	2	9-7/8	6
14570	25/32	.7812	2	9-7/8	6
14580	51/64	.7969	3	10-3/4	6-1/8
14590	13/16	.8125	3	10-3/4	6-1/8
14600	53/64	.8281	3	10-3/4	6-1/8
14610	27/32	.8438	3	10-3/4	6-1/8
14620	55/64	.8594	3	10-3/4	6-1/8
14630	7/8	.8750	3	10-3/4	6-1/8
14640	57/64	.8906	3	10-3/4	6-1/8
14650	29/32	.9062	3	10-3/4	6-1/8
14660	59/64	.9219	3	10-3/4	6-1/8
14670	15/16	.9375	3	10-3/4	6-1/8
14680	61/64	.9531	3	11	6-3/8
14690	31/32	.9688	3	11	6-3/8
14700	63/64	.9844	3	11	6-3/8
14710	1"	1.0000	3	11	6-3/8
14720	1-1/64	1.0156	3	11-1/8	6-1/2

FRACTIONAL

Part #	Diameter Inches	Decimal Equivalent Inches	Taper Shank	Overall Length Inches	Flute Length Inches
14730	1-1/32	1.0312	3	11-1/8	6-1/2
14740	1-3/64	1.0469	3	11-1/4	6-5/8
14750	1-1/16	1.0625	3	11-1/4	6-5/8
14760	1-5/64	1.0781	4	12-1/2	6-7/8
14770	1-3/32	1.0938	4	12-1/2	6-7/8
14780	1-7/64	1.1094	4	12-3/4	7-1/8
14790	1-1/8	1.1250	4	12-3/4	7-1/8
14800	1-9/64	1.1406	4	12-7/8	7-1/4
14810	1-5/32	1.1562	4	12-7/8	7-1/4
14820	1-11/64	1.1719	4	13	7-3/8
14830	1-3/16	1.1875	4	13	7-3/8
14840	1-13/64	1.2031	4	13-1/8	7-1/2
14850	1-7/32	1.2188	4	13-1/8	7-1/2
14860	1-15/64	1.2344	4	13-1/2	7-7/8
14870	1-1/4	1.2500	4	13-1/2	7-7/8
14880	1-17/64	1.2656	4	14-1/8	8-1/2
14890	1-9/32	1.2812	4	14-1/8	8-1/2
14900	1-19/64	1.2969	4	14-1/4	8-5/8
14910	1-5/16	1.3125	4	14-1/4	8-5/8
14920	1-21/64	1.3281	4	14-3/8	8-3/4
14930	1-11/32	1.3438	4	14-3/8	8-3/4
14940	1-23/64	1.3594	4	14-1/2	8-7/8
14950	1-3/8	1.3750	4	14-1/2	8-7/8
14960	1-25/64	1.3906	4	14-5/8	9
14970	1-13/32	1.4062	4	14-5/8	9
14980	1-27/64	1.4219	4	14-3/4	9-1/8
14990	1-7/16	1.4375	4	14-3/4	9-1/8
15000	1-29/64	1.4531	4	14-7/8	9-1/4
15010	1-15/32	1.4688	4	14-7/8	9-1/4
15020	1-31/64	1.4844	4	15	9-3/8
15030	1-1/2	1.5000	4	15	9-3/8
15040	1-17/32	1.5312	5	16-3/8	9-3/8
15050	1-9/16	1.5625	5	16-5/8	9-5/8
15060	1-19/32	1.5938	5	16-7/8	9-7/8
15070	1-5/8	1.6250	5	17	10
15080	1-21/32	1.6562	5	17-1/8	10-1/8
15090	1-11/16	1.6875	5	17-1/8	10-1/8
15100	1-23/32	1.7188	5	17-1/8	10-1/8
15110	1-3/4	1.7500	5	17-1/8	10-1/8
15120	1-25/32	1.7812	5	17-1/8	10-1/8
15130	1-13/16	1.8125	5	17-1/8	10-1/8
15140	1-27/32	1.8438	5	17-1/8	10-1/8
15150	1-7/8	1.8750	5	17-3/8	10-3/8
15160	1-29/32	1.9062	5	17-3/8	10-3/8
15170	1-15/16	1.9375	5	17-3/8	10-3/8
15180	1-31/32	1.9688	5	17-3/8	10-3/8
15190	2"	2.0000	5	17-3/8	10-3/8
15200	2-1/32	2.0312	5	17-3/8	10-3/8
15210	2-1/16	2.0625	5	17-3/8	10-1/4
15220	2-3/32	2.0938	5	17-3/8	10-1/4
15230	2-1/8	2.1250	5	17-3/8	10-1/4
15240	2-5/32	2.1562	5	17-3/8	10-1/4
15250	2-3/16	2.1875	5	17-3/8	10-1/4
15260	2-7/32	2.2188	5	17-3/8	10-1/8
15270	2-1/4	2.2500	5	17-3/8	10-1/8
15280	2-5/16	2.3125	5	17-3/8	10-1/8
15290	2-3/8	2.3750	5	17-3/8	10-1/8
15300	2-7/16	2.4375	5	18-3/4	11-1/4
15310	2-1/2	2.5000	5	18-3/4	11-1/4

Letter sizes continued page 49

Taper Shank

HSS TAPER SHANK - REGULAR

Type 510

High-Speed Steel Taper Shank Regular Shank - Black Oxide

LETTER

Part #	Letter Size	Decimal Equivalent Inches	Taper Shank	Overall Length Inches	Flute Length Inches
15700	A	.234	1	6-1/8	2-7/8
15710	B	.238	1	6-1/8	2-7/8
15720	C	.242	1	6-1/8	2-7/8
15730	D	.246	1	6-1/8	2-7/8
15740	E	.250	1	6-1/8	2-7/8
15750	F	.257	1	6-1/4	3
15760	G	.261	1	6-1/4	3
15770	H	.266	1	6-1/4	3
15780	I	.272	1	6-1/4	3
15790	J	.277	1	6-1/4	3
15800	K	.281	1	6-1/4	3
15810	L	.290	1	6-3/8	3-1/8
15820	M	.295	1	6-3/8	3-1/8
15830	N	.302	1	6-3/8	3-1/8
15840	O	.316	1	6-1/2	3-1/4
15850	P	.323	1	6-1/2	3-1/4
15860	Q	.332	1	6-1/2	3-1/4
15870	R	.339	1	6-1/2	3-1/4
15880	S	.348	1	6-3/4	3-1/2
15890	T	.358	1	6-3/4	3-1/2
15900	U	.368	1	6-3/4	3-1/2
15910	V	.377	1	7	3-5/8
15920	W	.386	1	7	3-5/8
15930	X	.397	1	7	3-5/8
15940	Y	.404	1	7	3-5/8
15950	Z	.413	1	7-1/4	3-7/8

Type 520

High-Speed Steel Taper Shank - Shank Larger than Regular - Black Oxide

- Taper shank drills are made to fit tapered holders.
- They are designed to perform well under a variety of normal conditions in a wide range of materials.
- Packaged individually.



FRACTIONAL

Part #	Diameter Inches	Decimal Equivalent Inches	Taper Shank	Overall Length Inches	Flute Length Inches
15450	3/8	.3750	2	7-3/8	3-1/2
15460	25/64	.3906	2	7-1/2	3-5/8
15470	13/32	.4062	2	7-1/2	3-5/8
15480	27/64	.4219	2	7-3/4	3-7/8
15490	7/16	.4375	2	7-3/4	3-7/8
15500	29/64	.4531	2	8	4-1/8
15510	15/32	.4688	2	8	4-1/8
15520	41/64	.6406	3	9-3/4	5-1/8
15530	21/32	.6262	3	9-3/4	5-1/8
15540	43/64	.6719	3	10	5-3/8
15550	11/16	.6875	3	10	5-3/8
15560	45/64	.7031	3	10-1/4	5-5/8
15570	23/32	.7188	3	10-1/4	5-5/8
15580	47/64	.7344	3	10-1/2	5-7/8
15590	3/4	.7500	3	10-1/2	5-7/8
15600	49/64	.7656	3	10-5/8	6
15610	25/32	.7812	3	10-5/8	6
15620	1"	1.0000	4	12	6-3/8
15630	1-1/32	1.0312	4	12-1/8	6-1/2
15640	1-1/16	1.0625	4	12-1/4	6-5/8

Type 500

High-Speed Steel Taper Shank - Shank Smaller than Standard - Black Oxide

- Taper shank drills are made to fit tapered holders.
- They are designed to perform well under a variety of normal conditions in a wide range of materials.
- Packaged individually.



FRACTIONAL

Part #	Diameter Inches	Decimal Equivalent Inches	Taper Shank	Overall Length Inches	Flute Length Inches
16050	31/64	.4844	1	7-3/4	4-3/8
16060	1/2	.5000	1	7-3/4	4-3/8
16070	33/64	.5156	1	8	4-5/8
16080	17/32	.5312	1	8	4-5/8
16090	35/64	.5469	1	8-1/4	4-7/8
16100	9/16	.5625	1	8-1/4	4-7/8
16110	51/64	.7969	2	10	6-1/8
16120	13/16	.8125	2	10	6-1/8
16130	53/64	.8281	2	10	6-1/8
16140	27/32	.8438	2	10	6-1/8
16150	55/64	.8594	2	10	6-1/8
16160	7/8	.8750	2	10	6-1/8
16170	57/64	.8906	2	10	6-1/8
16180	29/32	.9062	2	10	6-1/8
16190	1-5/64	1.0781	3	11-1/2	6-7/8
16200	1-3/32	1.0938	3	11-1/2	6-7/8
16210	1-7/64	1.1094	3	11-3/4	7-1/8
16220	1-1/8	1.1250	3	11-3/4	7-1/8
16230	1-9/64	1.1406	3	11-7/8	7-1/4
16240	1-5/32	1.1562	3	11-7/8	7-1/4
16250	1-11/64	1.1719	3	12	7-3/8
16260	1-3/16	1.1875	3	12	7-3/8
16270	1-13/64	1.2031	3	12-1/8	7-1/2
16280	1-7/32	1.2188	3	12-1/8	7-1/2
16290	1-15/64	1.2344	3	12-1/2	7-7/8
16300	1-1/4	1.2500	3	12-1/2	7-7/8
16320	1-17/32	1.5312	4	15	9-3/8
16340	1-9/16	1.5625	4	15-1/4	9-5/8
16360	1-19/32	1.5938	4	15-1/2	9-7/8
16380	1-5/8	1.6250	4	15-5/8	10
16400	1-21/32	1.6562	4	15-3/4	10-1/8
16420	1-11/16	1.6875	4	15-3/4	10-1/8
16440	1-23/32	1.7188	4	15-3/4	10-1/8
16460	1-3/4	1.7500	4	16-1/4	10-3/8
16470	1-25/32	1.7812	4	16-1/4	10-3/8
16480	1-13/16	1.8125	4	16-1/4	10-3/8
16490	1-27/32	1.8438	4	16-1/4	10-3/8
16500	1-7/8	1.8750	4	16-1/2	10-1/2
16510	1-29/32	1.9062	4	16-1/2	10-1/2
16520	1-15/16	1.9375	4	16-5/8	10-5/8
16530	1-31/32	1.9688	4	16-5/8	10-5/8
16540	2"	2.0000	4	16-5/8	10-5/8

DRILL BLANK

Type 240-DB

Jobber Length

Hardened and Ground - Bright Finish

- Fully hardened drill blanks typically used as hole size and bushing gauges.
- May also be used as guide pins for die sets.

Tolerances: +.0000 -.0005 thru 1/4" +.0000 -.0007 over 1/4

FRACTIONAL

Part #	Diameter Inches	Overall Length Inches	Qty. per/pack
02769	1/32	1-3/8	12
02779	3/64	1-3/4	12
02789	1/16	1-7/8	12
02799	5/64	2	12
02809	3/32	2-1/4	12
02819	7/64	2-5/8	12
02829	1/8	2-3/4	12
02839	9/64	2-7/8	12
02849	5/32	3-1/8	12
02859	11/64	3-1/4	12
02869	3/16	3-1/2	12
02879	13/64	3-5/8	12
02889	7/32	3-3/4	12
02899	15/64	3-7/8	12
02909	1/4	4	12
16919	17/64	4-1/8	12
16929	9/32	4-1/4	12
16939	19/64	4-3/8	6
16949	5/16	4-1/2	6
16959	21/64	4-5/8	6
16969	11/32	4-3/4	6
16979	23/64	4-7/8	6
16989	3/8	5	6
16999	25/64	5-1/8	6
17009	13/32	5-1/4	6
17019	27/64	5-3/8	6
17029	7/16	5-1/2	6
17039	29/64	5-5/8	6
17049	15/32	5-3/4	6
17059	31/64	5-7/8	6
17069	1/2	6	6

LETTER

Part #	Letter Sizes	Qty. per/pack
02419	A	12
02429	B	12
02439	C	12
02449	D	12
02459	E	12
02469	F	12
02479	G	12
02489	H	12
02499	I	12
02509	J	12
02519	K	12
02529	L	12
02539	M	6
02549	N	6
02559	O	6
02569	P	6
02579	Q	6
02589	R	6
02599	S	6
02609	T	6
02619	U	6
02629	V	6
02639	W	6
02649	X	6
02659	Y	6
26960	Z	6

WIRE

Part #	Wire Sizes	Overall Length Inches	Qty. per/pack
03199	1	3-7/8	12
03209	2	3-7/8	12
03219	3	3-3/4	12
03229	4	3-3/4	12
03239	5	3-3/4	12
03249	6	3-3/4	12
03259	7	3-5/8	12
03269	8	3-5/8	12
03279	9	3-5/8	12
03289	10	3-5/8	12
03299	11	3-1/2	12
03309	12	3-1/2	12
03319	13	3-1/2	12
03329	14	3-3/8	12
03339	15	3-3/8	12
03349	16	3-3/8	12
03359	17	3-3/8	12
03369	18	3-1/4	12
03379	19	3-1/4	12
03389	20	3-1/4	12
03399	21	3-1/4	12
03409	22	3-1/8	12
03419	23	3-1/8	12
03429	24	3-1/8	12
03439	25	3	12
03449	26	3	12
03459	27	3	12
03469	28	2-7/8	12
03479	29	2-7/8	12
03489	30	2-3/4	12
03499	31	2-3/4	12
03509	32	2-3/4	12
03519	33	2-5/8	12
03529	34	2-5/8	12
03539	35	2-5/8	12
03549	36	2-1/2	12
03559	37	2-1/2	12
03569	38	2-1/2	12
03579	39	2-3/8	12
03589	40	2-3/8	12
03599	41	2-3/8	12
03609	42	2-1/4	12
03619	43	2-1/4	12
03629	44	2-1/8	12
03639	45	2-1/8	12
03649	46	2-1/8	12
03659	47	2	12
03669	48	2	12
03679	49	2	12
03689	50	2	12
03699	51	2	12
03709	52	1-7/8	12
03719	53	1-7/8	12
03729	54	1-7/8	12
03739	55	1-7/8	12
03749	56	1-3/4	12
03759	57	1-3/4	12
03769	58	1-5/8	12
03779	59	1-5/8	12
03789	60	1-5/8	12
03799	61	1-5/8	12
03809	62	1-1/2	12
03819	63	1-1/2	12
03829	64	1-1/2	12
03839	65	1-1/2	12
03849	66	1-3/8	12
03859	67	1-3/8	12
03869	68	1-3/8	12
03879	69	1-3/8	12
03889	70	1-1/4	12
03899	71	1-1/4	12
03919	72	1-1/8	12
03929	73	1-1/8	12
03939	74	1	12
03949	75	1	12
03959	76	7/8	12
03969	77	7/8	12
03979	78	7/8	12
03989	79	3/4	12
03999	80	3/4	12

Technical Reference

Decimal Equivalent & Tap Drill Sizes Chart

Drill Size	Decimal	Drill Size	Decimal	Drill Size	Decimal	Drill Size	Decimal	Drill Size	Decimal
00.10	.0039	54	.0550	25	.1495	H	.2660	29/64	.4531
97	.0059	01.40	.0551	03.80	.1496	06.80	.2677	11.80	.4646
96	.0063	01.45	.0571	24	.1520	06.90	.2717	15/32	.4688
95	.0067	01.50	.0591	03.90	.1535	I	.2720	12.00	.4724
94	.0071	53	.0595	23	.1540	07.00	.2756	12.20	.4803
93	.0075	01.55	.0610	5/32	.1562	J	.2770	31/64	.4844
92	.0079	1/16	.0625	22	.1570	07.10	.2795	12.50	.4921
00.20	.0079	01.60	.0630	04.00	.1575	K	.2810	1/2	.5000
91	.0083	52	.0635	21	.1590	9/32	.2812	13.00	.5118
90	.0087	01.65	.0650	20	.1610	07.20	.2835	33/64	.5156
89	.0091	01.70	.0669	04.10	.1614	07.30	.2874	17/32	.5312
88	.0095	51	.0670	04.20	.1654	L	.2900	13.50	.5315
87	.0100	01.75	.0689	19	.1660	07.40	.2913	35/64	.5469
86	.0105	50	.0700	04.30	.1693	M	.2950	14.00	.5512
85	.0110	01.80	.0709	18	.1695	07.50	.2953	9/16	.5625
84	.0115	01.85	.0728	11/64	.1719	19/64	.2969	14.50	.5709
00.30	.0118	49	.0730	17	.1730	07.60	.2992	37/64	.5781
83	.0120	01.90	.0748	04.40	.1732	N	.3020	15.00	.5906
82	.0125	48	.0760	16	.1770	07.70	.3031	19/32	.5938
81	.0130	01.95	.0768	04.50	.1772	07.80	.3071	39/64	.6094
80	.0135	5/64	.0781	15	.1800	07.90	.3110	15.50	.6102
00.35	.0138	47	.0785	04.60	.1811	5/16	.3125	5/8	.6250
79	.0145	02.00	.0787	14	.1820	08.00	.3150	16.00	.6299
1/64	.0156	02.05	.0807	13	.1850	O	.3160	41/64	.6406
00.40	.0157	46	.0810	04.70	.1850	08.10	.3189	16.50	.6496
78	.0160	45	.0820	3/16	.1875	08.20	.3228	21/32	.6562
00.45	.0177	02.10	.0827	12	.1890	P	.3230	17.00	.6693
77	.0180	02.15	.0846	04.80	.1890	08.30	.3268	43/64	.6719
00.50	.0197	44	.0860	11	.1910	21/64	.3281	11/16	.6875
76	.0200	02.20	.0866	04.90	.1929	08.40	.3307	17.50	.6890
75	.0210	02.25	.0886	10	.1935	Q	.3320	45/64	.7031
00.55	.0217	43	.0890	9	.1960	08.50	.3346	18.00	.7087
74	.0225	02.30	.0906	05.00	.1969	08.60	.3386	23/32	.7188
00.60	.0236	02.35	.0925	8	.1990	R	.3390	18.50	.7283
73	.0240	42	.0935	05.10	.2008	08.70	.3425	47/64	.7344
72	.0250	3/32	.0938	7	.2010	11/32	.3438	19.00	.7480
00.65	.0256	02.40	.0945	13/64	.2031	08.80	.3465	3/4	.7500
71	.0260	41	.0960	6	.2040	S	.3480	49/64	.7656
00.70	.0276	02.45	.0965	05.20	.2047	08.90	.3504	19.50	.7677
70	.0280	40	.0980	5	.2055	09.00	.3543	25/32	.7812
69	.0292	02.50	.0984	05.30	.2087	T	.3580	20.00	.7874
00.75	.0295	39	.0995	4	.2090	09.10	.3583	51/64	.7969
68	.0310	38	.1015	05.40	.2126	23/64	.3594	20.50	.8071
1/32	.0312	02.60	.1024	3	.2130	09.20	.3622	13/16	.8125
00.80	.0315	37	.1040	05.50	.2165	09.30	.3661	21.00	.8268
67	.0320	02.70	.1063	7/32	.2188	U	.3680	53/64	.8281
66	.0330	36	.1065	05.60	.2205	09.40	.3701	27/32	.8438
00.85	.0335	7/64	.1094	2	.2210	09.50	.3740	21.50	.8465
65	.0350	35	.1100	05.70	.2244	3/8	.3750	55/64	.8594
00.90	.0354	02.80	.1102	1	.2280	V	.3770	22.00	.8661
64	.0360	34	.1110	05.80	.2283	09.60	.3780	7/8	.8750
63	.0370	33	.1130	05.90	.2323	09.70	.3819	22.50	.8858
00.95	.0374	02.90	.1142	A	.2340	09.80	.3858	57/64	.8906
62	.0380	32	.1160	15/64	.2344	W	.3860	23.00	.9055
61	.0390	03.00	.1181	06.00	.2362	09.90	.3898	29/32	.9062
01.00	.0394	31	.1200	B	.2380	25/64	.3906	59/64	.9219
60	.0400	03.10	.1220	06.10	.2402	10.00	.3937	23.50	.9252
59	.0410	1/8	.1250	C	.2420	X	.3970	15/16	.9375
01.05	.0413	03.20	.1260	06.20	.2441	10.20	.4016	24.00	.9449
58	.0420	30	.1285	D	.2460	Y	.4040	61/64	.9531
57	.0430	03.30	.1299	06.30	.2480	10.30	.4055	24.50	.9646
01.10	.0433	03.40	.1339	1/4	.2500	13/32	.4062	31/32	.9688
01.15	.0453	29	.1360	E	.2500	Z	.4130	25.00	.9843
56	.0465	03.50	.1378	06.40	.2520	10.50	.4134	63/64	.9844
3/64	.0469	28	.1405	06.50	.2559	27/64	.4219	1	1.0000
01.20	.0472	9/64	.1406	F	.2570	10.80	.4252		
01.25	.0492	03.60	.1417	06.60	.2598	11.00	.4331		
01.30	.0512	27	.1440	G	.2610	7/16	.4375		
55	.0520	03.70	.1457	06.70	.2638	11.20	.4409		
01.35	.0531	26	.1470	17/64	.2656	11.50	.4528		

Technical Reference - Decimal Equivalent

TAP DRILL SIZES							
Thread	Drill	Thread	Drill	Thread	Drill	Thread	Drill
0-80	3/64	6-32	36	M8.0-1.25	H	M16-2	14.0M
M1.6-.35	1.25M	6-40	33	5/16-24	I	5/8-11	17/32
1-64	54	M3.5-.6	2.90M	M8.0-1	7.0M	M16-1.5	14.5M
M1.8-.35	1.45M	M4.0-.7	3.30M	3/8-16	5/16	5/8-18	37/64
1-72	53	8-32	29	3/8-24	Q	M18-2.5	15.5M
M2.0-.4	1.60M	8-36	29	M10-1.5	8.5M	M18-1.5	16.5M
2-56	51	M4.5-.75	26	M10-1.25	11/32	3/4-10	21/32
M2.2-.45	1.75M	10-24	25	7/16-14	U	3/4-16	11/16
2-64	50	10-32	21	7/16-20	25/64	M20-2.5	17.5M
3-48	47	M5.0-.8	4.20M	M12-1.75	Y	M20-1.5	18.5M
M2.5-.45	2.05M	12-24	16	1/2-13	27/64	7/8-9	49/64
3-56	45	12-28	14	M12-1.25	10.8M	M22-2.5	19.5M
4-40	43	M6.0-1	5.0M	1/2-20	29/64	M22-1.5	20.5M
4-48	42	1/4-20	7	M14-2	12.0M	7/8-14	13/16
M3.0-.5	2.50M	1/4-28	3	9/16-12	31/64	M24-3	21.0M
5-40	38	M7.0-1	6.0M	M14-1.5	12.5M	M24-2	22.0M
5-44	37	5/16-18	F	9/16-18	33/64	1-8	7/8
						1-12	59/64
						1-14	15/16

Drill Feed & Speeds

Different drilling conditions make it impossible to develop any rigid rules for feeds and speeds. The following tables contain guidelines which can be utilized when drilling standard materials. Also, the following "rules of thumb" can be used to determine proper feeds and speeds for drilling ferrous materials (note: varying conditions can easily require adjustments).

Feed equals .001" per revolution for every 1/16" of drill diameter, plus or minus .001" on the total.

Speed equals 80 surface feet per minute in 100 Brinell hardness material and the speed should be reduced 10 surface feet per minute for each additional 50 points Brinell hardness.

Feed and speed rates should be reduced up to 45-50 % when drilling holes deeper than 4 drill diameters.

Recommended Feeds

RECOMMENDED FEEDS FOR VARIOUS DIAMETER DRILLS	
Diameter of Drill—Inches	Feed Inches per Revolution
Under 1/8	.001 to .003
1/8 to 1/4	.002 to .006
1/4 to 1/2	.004 to .010
1/2 to 1	.007 to .015
1 inch and over	.015 to .025

NOTE: It is best to start with a moderate speed and feed, increasing either one, or both, after observing the action and condition of the drill.

Recommended Speeds

RECOMMENDED SPEEDS FOR STANDARD MATERIALS WITH H.S.S. DRILLS	
Material	Recommended Speed (sfm)
Aluminum and its Alloys	200—300
Brass and Bronze (ordinary)	150—300
Bronze (High Tensile)	70—150
Die Castings (Zinc Base)	300—400
Iron—Cast (soft)	75—125
Cast (medium hard)	50—100
Hard Chilled	10—20
Malleable	80—90
Magnesium and its Alloys	250—400
Monel Metal or High-Nickel Steel	30—50
Plastics or Similar Materials	100—300
Steel—	
Mild .2 carbon to .3 carbon	80—110
Steel .4 carbon to .5 carbon	70—80
Tool 1.2 carbon	50—60
Forgings	40—50
Alloy—300 to 400 Brinell	20—30
High Tensile (Heat Treated)	
35 to 40 Rockwell "C"	30—40
40 to 45 Rockwell "C"	25—35
45 to 50 Rockwell "C"	15—25
50 to 55 Rockwell "C"	7—15
Stainless Steel	
Free Machining Grades	30—80
Work Hardening Grades	15—50
Titanium Alloy Sheet	50—60
Titanium Alloys	
Ti-75A (Commercially Pure)	50—60
RS-120	40—60
Ti-150A	40—50
Ti-140A	30—40
RC-130B	30—40
MST 6A1-4 Va.	20—35
MST 3A1-5 Cr.	10—20

Formulas

1. **R.P.M.** = (3.8197 / Drill Diameter) x S.F.M.
2. **S.F.M.** = 0.2618 x Drill Diameter x R.P.M.
3. **I.P.M.** = I.P.R. (feed) x R.P.M. (speed)
4. Machine Time (seconds) = (60 x Feed minus Stroke) / I.P.M.

R.P.M. = Revolutions Per Minute

I.P.R. = Inches Per Revolution

S.F.M. = Surface Feet Per Minute

Feed Stroke = Drill Depth + 1/3

I.P.M. = Inches Per Minute

Car Reamer = 1/2 Speed of Drill

Cutting Speed

DRILL SIZE	CUTTING SPEED — FEET PER MINUTE				
	20	40	60	80	100
	REVOLUTIONS	PER	PER	PER	PER
1/64	4.89	9.78	14.78	19.72	24.45
1/16	1.22	2.44	3.70	4.93	6.11
1/8	.61	1.22	1.83	2.44	3.06
3/16	.41	.82	1.23	1.63	2.04
1/4	.30	.61	.92	1.22	1.53
5/16	.24	.49	.74	.98	1.22
3/8	.20	.41	.61	.81	1.02
7/16	.18	.35	.52	.70	.87
1/2	.15	.31	.46	.61	.76
9/16	.14	.27	.41	.54	.68
5/8	.12	.24	.37	.49	.61
11/16	.11	.22	.34	.45	.56
3/4	.10	.20	.31	.41	.51
13/16	.09	.19	.28	.38	.47
7/8	.09	.18	.26	.35	.44
15/16	.08	.16	.25	.33	.41
1	.08	.15	.23	.30	.38

PROBLEM	CAUSE	CORRECTION
BROKEN DRILL	1. Flutes clogged with chips, drill binds in hole (common in deep holes)	—Use drill with wider flutes and/or faster helix angle —Consider polished flutes —Withdraw drill at regular intervals to clear chips —If chips are not broken up, consider heavier feeds—or a chip breaker design
	2. Drill binding due to worn outer corners	—Repoint or replace drill —Check for excessive speed, inadequate or incorrect coolant, excessive run out as drill enters work
	3. Work insecurely held	—Use adequate holding or clamping devices
	4. Excessive feed	—Reduce feed
	5. Improper point	—Check for correct lip clearance —Use proper type of drill and point for the application
	6. Drill is dull	—Replace before dulling occurs. Check feeds, speeds, and No. 5 for premature dulling
BROKEN TANG	1. Shank or socket damaged	—Repair or replace
	2. Drill not properly seated in socket	—Check for positive, secure fit
CHIPS NOT BREAKING UP	1. Insufficient feed	—Increase feed
	2. Improper style of drill and/or point	—Consider use of chip-breaker design drill and/or chip-breaker point grind
DAMAGED POINT	1. Using hard object to tap drill into tool holder	—Use soft lead, brass, plastic, etc. hammer
	2. Dropping, mishandling drill	—Handle with care
OVERSIZE HOLE	1. Drill point off center	—Repoint accurately or replace with properly pointed drill
	2. Machine spindle not rigid or not running true	—Repair if possible; consider use of bushing
	3. Work piece loose and/or vibrating	—Tighten and hold securely
ROUGH HOLE	1. Incorrect point grind and/or dull drill	—Repoint or replace with properly pointed drill
	2. Excessive feed	—Reduce feed
	3. Incorrect or insufficient coolant	—Correct and adjust
POOR TOOL LIFE	1. Coolant not reaching drill point or insufficient or incorrect coolant	—Correct and adjust
	2. Speed too high and/or feed too low	—Review and adjust
	3. Wrong type of point and/or drill for application	—Review requirements and conditions
WEB SPLITS	1. Insufficient lip clearance	—Repoint or replace with properly pointed drill
	2. Point thinned too much	—Repoint or replace with properly pointed drill
	3. Excessive feed	—Reduce feed
CHIPPED LIPS	1. Excessive lip clearance and/or heel relief	—Repoint or replace with properly pointed drill
BROKEN OUTER CORNERS	1. Insufficient or incorrect coolant	—Correct and adjust
	2. Excessive speed	—Reduce speed
	3. Scale, hard spots encountered in material	—No final remedy if this condition is prevalent; lower feeds and speeds may help

Taps & Dies

HSS Spiral Point Taps

Type 20-UB Fractional / Machine Screw	55
Type 20-UBN Fractional / Machine Screw	55
Type 20 Fractional / Machine Screw	55
Type 21-UB Metric	55
Type 21-UBN Metric - Titanium Nitride	55
Type 21 Metric	55

HSS Straight Flute Taps

Type 23-UB Taper	58 - 60
Type 23-UBN Taper - Titanium Coated	58 - 60
Type 23 Taper	58 - 60
Type 24-UB Plug	58 - 60
Type 24-UBN Plug - Titanium Coated	58 - 60
Type 24 Plug	58 - 60
Type 25-UB Bottoming	58 - 60
Type 25-UBN Bottoming - Titanium Nitride	58 - 60
Type 25 Bottoming	58 - 60
Type 26-UB Sets	61
Type 26-UBN Sets Titanium Nitride	61
Type 26 Sets	61

HSS Straight Flute -Metric

Type 31-UB Taper	62
Type 31-UBN Taper - Titanium Nitride	62
Type 31 Taper	62
Type 32-UB Plug	62
Type 32-UBN Plug - Titanium Nitride	62
Type 32 Plug	62
Type 33-UB Bottoming	62
Type 33-UBN Bottoming - Titanium Nitride	62
Type 33 Bottoming	62
Type 35-UB Sets	63
Type 35-UBN Sets Titanium Nitride	63
Type 35 Sets	63

HSS Straight Flute - Left-Hand Thread

Type 23L-UB Taper	64
Type 24L-UB Plug	64
Type 25L-UB Bottoming	64

NEW HSS Combination Drill & Tap

Type 40-UB	65
Type 40-QR	65

Drill & Tap Combo

Type 34-UB	65
------------	----

HSS Hex Dies

Type 27-UB	66
Type 27-UB Metric	66

Reduced Neck

Type 29-UB	56
Type 29-UBN - Titanium Nitride	56
Type 29-ACN	57
Type 29-ALN	57

NEW M42 Cobalt Taps

Type 24-RNC	58
Type 24-RNCN - Titanium Nitride	58

Taper Pipe Taps

Type 30-UB	63
Type 30-UBN - Titanium Nitride	63
Type 30-B Black Oxide	63
Type 30 Bright	63
Type I30-UB Interrupted	63
Type I30-UBN Titanium Nitride - Interrupted	63
Type I30-B Black Oxide - Interrupted	63
Type I30 Bright - Interrupted	63

HSS Tap & Drill Sets

SF-18TDC Straight Flute	65
SF-18TDF Spiral Flute	65
SP-10TD Straight Point	65
SP-12TD Spiral Point	65
SP-18TD Spiral Point	65
SP-18TDM Spiral Point	65

HSS Tap Sets

SP-19T Spiral Point	66
SP-10T Spiral Point	66
SF-10T Straight Flute	66

Drill, Tap & Countersink Set

TDC-12	66
--------	----

HSS Tap & Die Assortments

Ultra Bor Super Premium	
14pc, 15pc Metric	67
23pc, 25pc Metric	67
40pc	68
58pc	68

Hi-Carbon Steel Taps

Type 720 Plug - Fractional	69
Type 721 Plug - Machine Screw	69
Type 740 Taper - Fractional	69
Type 741 Taper - Machine Screw	69
Type 760 Bottoming - Fractional	70
Type 761 Bottoming - Machine Screw	70
Type 722 3 pc - Fractional Set	70
Type 723 3 pc - Machine Screw	70
Type 780 Plug Taps - Metric	73

Hi-Carbon Steel Pipe Taps

Type 410 Fractional	73
---------------------	----

Hi-Carbon Steel Dies

Type 400 - Round	72
Type 405 - Hex	71
Type 415 - Adjustable	72
Type 790 - Hex Metric	71

Hi-Carbon Tap & Die Sets

Type 724	
14pc, 16pc	74
24pc, 37pc	75
40pc	76

Tap & Reamer

Wrenches / Die Stocks

Type 725, Type 726	77
Type 727	77
Type 727R Ratcheting T-Handle	77
Type 728	78
Type 729	78
Type 730	78

Technical Reference . 79 - 83



HSS SPIRAL POINT PLUG TAPS

Gun Tap - Machine Screw / Fractional & METRIC - Ground Thread - Ultra Bor Super Premium

Types 20-UB Gold Oxide, Type 20-UBN Titanium Nitride & Type 20 Bright METRIC Types 21-UB Gold Oxide, Type 21-UBN Titanium Nitride & Type 21 Bright

- Spiral point taps are designed for machine tapping through holes in a wide variety of materials. The point of the tap continuously ejects the chips ahead of the tap, eliminating chip disposal problems and thread damage.



Type 20-UB

Gold Oxide - low temperature stress relief that enhances lubricity, reduces friction and increases tap toughness.



Type 20-UBN Titanium Nitride

Titanium Nitride - increases wear resistance by producing a higher surface hardness and exceptional lubricity resulting in longer tool life.



Type 20 Bright Finish Bright Finish

Red Bold = most common used Taps

20-UB Part #	20-UBN Part #	20 Part #	Size	# of Flutes	H Limit	Qty. per/pack
67502	10502	60101	0-80	2	H1	3
60100	10512	67501	0-80	2	H2	3
67512	10522	60111	1-64	2	H1	3
60110	10532	67511	1-64	2	H2	3
67522	10542	67521	1-72	2	H1	3
60120	10552	60121	1-72	2	H2	3
60130	10562	60131	2-56	2	H2	3
60140	10572	60141	2-64	2	H2	3
60150	10582	60151	3-48	2	H2	3
67532	10592	67531	3-56	2	H1	3
60160	10602	60161	3-56	2	H2	3
67542	10612	67541	4-40	2	H1	3
60170	10622	60171	4-40	2	H2	3
67552	10632	67551	4-48	2	H1	3
60180	10642	60181	4-48	2	H2	3
60190	10652	60191	4-36	2	H2	3
67562	10662	67561	5-40	2	H1	3
60200	10672	60201	5-40	2	H2	3
60210	10682	60211	5-44	2	H2	3
67572	10692	67571	6-32	2	H1	3
67582	10702	67581	6-32	2	H2	3
60220	10712	60221	6-32	2	H3	3
60230	10722	60231	6-40	2	H2	3
67592	10732	67591	8-32	2	H1	3
67602	10742	67601	8-32	2	H2	3
60240	10752	60241	8-32	2	H3	3
60250	10762	60251	8-36	2	H2	3
67612	10772	67611	10-24	2	H1	3
67622	10782	67621	10-24	2	H2	3
60260	10792	60261	10-24	2	H3	3
67632	10802	67631	10-32	2	H1	3
67642	10812	67641	10-32	2	H2	3
60270	10822	60271	10-32	2	H3	3
60280	10832	60281	12-24	2	H3	3
60290	10842	60291	12-28	2	H3	3
67652	10852	67651	1/4-20	2	H1	3
67662	10862	67661	1/4-20	2	H2	3
60320	10872	60321	1/4-20	2	H3	3
67672	10882	67671	1/4-20	2	H5	3
67682	10892	67681	1/4-20	3	H3	3
67692	10902	67691	1/4-20	3	H5	3
67702	10912	67701	1/4-28	2	H1	3
67712	10922	67711	1/4-28	2	H2	3
60330	10932	60331	1/4-28	2	H3	3

20-UB Part #	20-UBN Part #	20 Part #	Size	# of Flutes	H Limit	Qty. per/pack
67722	10942	67721	1/4-28	2	H4	3
67732	10952	67731	1/4-28	3	H2	3
67742	10962	67741	1/4-28	3	H4	3
67752	10972	67751	5/16-18	2	H1	3
67762	10982	67761	5/16-18	2	H2	3
60340	10992	60341	5/16-18	2	H3	3
67772	11002	67771	5/16-18	2	H5	3
67782	11012	67781	5/16-18	3	H3	3
67792	11022	67791	5/16-18	3	H5	3
67802	11032	67801	5/16-24	2	H1	3
67812	11042	67811	5/16-24	2	H2	3
60350	11052	60351	5/16-24	2	H3	3
67822	11062	67821	5/16-24	2	H4	3
67832	11072	67831	5/16-24	3	H2	3
67842	11082	67841	5/16-24	3	H4	3
67852	11092	67851	3/8-16	3	H1	3
67862	11102	67861	3/8-16	3	H2	3
60360	11112	60361	3/8-16	3	H3	3
67872	11122	67871	3/8-16	3	H5	3
67882	11132	67881	3/8-24	3	H1	3
67892	11142	67891	3/8-24	3	H2	3
60370	11152	60371	3/8-24	3	H3	3
67902	11162	67901	3/8-24	3	H4	3
67912	11172	67911	7/16-14	3	H2	3
60380	11182	60381	7/16-14	3	H3	3
67922	11192	67921	7/16-14	3	H5	3
60390	11202	60391	7/16-20	3	H3	3
67932	11212	67931	7/16-20	3	H5	3
67942	11222	67941	1/2-13	3	H2	3
60400	11232	60401	1/2-13	3	H3	3
67952	11242	67951	1/2-13	3	H5	3
67962	11252	67961	1/2-20	3	H1	3
67972	11262	67971	1/2-20	3	H2	3
60410	11272	60411	1/2-20	3	H3	3
67982	11282	67981	1/2-20	3	H5	3
67992	-----	60461	9/16-12	3	H3	1
68002	-----	60471	9/16-18	3	H3	1
60420	11292	60421	5/8-11	3	H3	1
68012	11302	67991	5/8-11	3	H5	1
60430	11312	60431	5/8-18	3	H3	1
60440	11322	60441	3/4-10	3	H3	1
68022	11332	68001	3/4-10	3	H5	1
60450	11342	60451	3/4-16	3	H3	1

TYPE 21-UB, TYPE 21-UBN TITANIUM NITRIDE & TYPE 21

METRIC - PLUG

21-UB Part #	21-UBN Part #	21 Part #	Size	# of Flutes	PD Limit	Qty. per/pck
68602	10509	68601	1.6 - 0.35	2	D3	3
68612	10519	68611	1.8 - 0.35	2	D3	3
68622	10529	68621	2.0 - 0.40	2	D3	3
68632	10539	68631	2.20 - 0.45	2	D3	3
60500	10549	68641	2.5 - 0.45	2	D3	3
60510	10559	60102	3.0 - 0.50	2	D3	3
60520	10569	60103	3.5 - 0.60	2	D4	3
60530	10579	60104	4.0 - 0.70	2	D4	3
68642	10589	68651	4.50 - 0.75	2	D4	3
60550	10599	60114	5.0 - 0.80	2	D4	3
60560	10609	60124	6.0 - 1.00	2	D5	3
68652	10619	68661	7.0 - 1.00	2	D5	3

21-UB Part #	21-UBN Part #	21 Part #	Size	# of Flutes	PD Limit	Qty. per/pck
68662	10629	68671	8.0 - 1.00	2	D5	3
60580	10639	60234	8.0 - 1.25	2	D5	3
68672	10649	68681	10.0 - 1.25	3	D5	3
60600	10659	60152	10.0 - 1.50	3	D6	3
68682	10669	68691	12.0 - 1.25	3	D5	3
60620	10679	60162	12.0 - 1.75	3	D6	3
68692	10689	68701	14.0 - 1.50	3	D6	1
60630	10699	60164	14.0 - 2.00	3	D7	1
68702	10709	68711	16.0 - 1.50	3	D6	1
60640	10719	60173	16.0 - 2.00	3	D7	1
60650	10729	60174	18.0 - 2.50	3	D7	1
68712	10739	68721	20.0 - 2.50	3	D7	1

HSS Taps



HIGH PERFORMANCE REDUCED NECK - SPIRAL POINT TAPS

Machine Screw / Fractional & METRIC

Type 29-UB - Gold Oxide

Type 29-UBN - Titanium Nitride

- Special tool geometry creates less torque, better removal of chips and runs cooler.
- Designed for difficult materials including: stainless steel, alloy steels and high carbon steel.



Type 29-UB

Gold Oxide - low temperature stress relief that enhances lubricity, reduces friction and increases tap toughness.



Type 29-UBN

Titanium nitride - increases wear resistance by producing a higher surface hardness and exceptional lubricity resulting in longer tool life.

GOLD OXIDE

TYPE 29-UB

METRIC

Part #	Size	# of Flutes	H Limits	Qty. per/pack
44264	2-56	2	H2	3
44284	3-48	2	H2	3
44300	4-40	2	H2	3
44294	4-48	2	H2	3
44304	5-40	2	H2	3
44309	5-44	2	H2	3
44310	6-32	3	H3	3
44320	6-40	3	H2	3
44334	8-32	2	H3	3
44330	8-32A	3	H3	3
44344	8-36	2	H2	3
44340	8-36A	3	H2	3
44354	10-24	2	H3	3
44350	10-24A	3	H3	3
44364	10-32	2	H3	3

Part #	Size	# of Flutes	H Limits	Qty. per/pack
44360	10-32A	3	H3	3
44374	12-24	2	H3	3
44370	12-24A	3	H3	3
44384	12-28	2	H3	3
44380	12-28A	3	H3	3
20013	1/4-20	2	H3	3
20010	1/4-20A	3	H3	3
20023	1/4-28	2	H3	3
20020	1/4-28A	3	H2	3
20033	5/16-18	2	H3	3
20030	5/16-18A	3	H3	3
20043	5/16-24	2	H3	3
20040	5/16-24A	3	H2	3
20050	3/8-16	3	H3	3
20060	3/8-24	3	H3	3

Part #	Size	# of Flutes	H Limits	Qty. per/pack
20100	7/16-14	3	H3	3
20110	7/16-20	3	H3	3
20120	1/2-13	3	H3	3
20130	1/2-20	3	H3	3
20163	9/16-12	3	H3	1
20173	9/16-18	3	H3	1
20183	5/8-11	3	H3	1
20193	5/8-18	3	H3	1
20203	3/4-10	3	H3	1
20213	3/4-16	3	H3	1
20223	7/8-9	3	H3	1
20233	7/8-14	3	H3	1
20243	1-8	3	H3	1
20253	1-14	3	H3	1

Part #	Size	# of Flutes	PD Limits	Qty. per/pack
24494	3-.50	2	D3	3
24514	4-.70	3	D4	3
24534	5-.80	3	D4	3
24544	6-1.00	3	D5	3
24574	8-1.25	3	D5	3
24594	10-1.50	3	D6	3
24614	12-1.75	3	D6	3
24634	14-2.00	3	D7	1
24654	16-2.00	3	D7	1

TITANIUM NITRIDE

TYPE 29-UBN

METRIC

Part #	Size	# of Flutes	H Limits	Qty. per/pack
09501	2-56	2	H2	3
09511	3-48	2	H2	3
09521	4-40	2	H2	3
09531	4-48	2	H2	3
09541	5-40	2	H2	3
09551	5-44	2	H2	3
09561	6-32	3	H3	3
09571	6-40	3	H2	3
09581	8-32	2	H3	3
09591	8-32A	3	H3	3
09601	8-36	2	H2	3
09611	8-36A	3	H2	3
09621	10-24	2	H3	3
09631	10-24A	3	H3	3
09641	10-32	2	H3	3
09651	10-32A	3	H3	3
09661	12-24	2	H3	3
09671	12-24A	3	H3	3
09681	12-28	2	H3	3

Part #	Size	# of Flutes	H Limits	Qty. per/pack
09691	12-28A	3	H3	3
09701	1/4-20	2	H3	3
09711	1/4-20A	3	H3	3
09721	1/4-28	2	H3	3
09731	1/4-28A	3	H2	3
09741	5/16-18	2	H3	3
09751	5/16-18A	3	H3	3
09761	5/16-24	2	H3	3
09771	5/16-24A	3	H2	3
09781	3/8-16	3	H3	3
09791	3/8-24	3	H3	3
09801	7/16-14	3	H3	3
09811	7/16-20	3	H3	3
09821	1/2-13	3	H3	3
09831	1/2-20	3	H3	3
09841	9/16-12	3	H3	1
09851	9/16-18	3	H3	1
09861	5/8-11	3	H3	1
09871	5/8-18	3	H3	1

Part #	Size	# of Flutes	H Limits	Qty. per/pack
09881	3/4-10	3	H3	1
09891	3/4-16	3	H3	1
09901	7/8-9	3	H3	1
09911	7/8-14	3	H3	1
09921	1-8	3	H3	1
09931	1-14	3	H3	1

Part #	Size	# of Flutes	PD Limits	Qty. per/pack
09941	3-.50	2	D3	3
09951	4-.70	3	D4	3
09961	5-.80	3	D4	3
09971	6-1.00	3	D5	3
09981	8-1.25	3	D5	3
09991	10-1.50	3	D6	3
10001	12-1.75	3	D6	3
10011	14-2.00	3	D7	1
10021	16-2.00	3	D7	1

HIGH PERFORMANCE REDUCED NECK - SPIRAL POINT TAPS



TiCN Coating

Titanium Carbon Nitride (TiCN) Hi productivity when threading stainless steel, nickel and aluminum for use in multiple applications.



TiAlN Coating

Titanium Aluminum Nitride (TiAlN) ideal for threading hard materials designed for hardened steels and cast iron up to 45 Rockwell C.

Titanium Aluminum Nitride - TiAlN coating provides extreme toughness, recommended for high temperature operations and difficult to machine materials.

• Designed for hardened steels and cast iron up to 45 Rockwell C.

Machine Screw / Fractional & METRIC
Type 29-ACN - Titanium Carbon Nitride
Type 29-ALN - Titanium Aluminum Nitride

- Titanium Carbon Nitride - TiCN coating that is harder than TiN coating resulting in longer tool life and enhanced performance.
- For use in multiple applications.

TITANIUM CARBON NITRIDE

TYPE 29-ACN

Part #	Size	# of Flutes	H Limits	Qty. per/pack
31001	2-56	2	H2	3
31011	3-48	2	H2	3
31021	4-40	2	H2	3
31031	4-48	2	H2	3
31041	5-40	2	H2	3
31051	5-44	2	H2	3
31061	6-32	3	H3	3
31071	6-40	3	H2	3
31081	8-32	2	H3	3
31091	8-32A	3	H3	3
31101	8-36	2	H2	3
31111	8-36A	3	H2	3
31121	10-24	2	H3	3
31131	10-24A	3	H3	3
31141	10-32	2	H3	3
31151	10-32A	3	H3	3
31161	12-24	2	H3	3
31171	12-24A	3	H3	3
31181	12-28	2	H3	3

Part#	Size	# of Flutes	H Limits	Qty. per/pack
31191	12-28A	3	H3	3
31201	1/4-20	2	H3	3
31211	1/4-20A	3	H3	3
31221	1/4-28	2	H3	3
31231	1/4-28A	3	H2	3
31241	5/16-18	2	H3	3
31251	5/16-18A	3	H3	3
31261	5/16-24	2	H3	3
31271	5/16-24A	3	H2	3
31281	3/8-16	3	H3	3
31291	3/8-24	3	H3	3
31301	7/16-14	3	H3	3
31311	7/16-20	3	H3	3
31321	1/2-13	3	H3	3
31331	1/2-20	3	H3	3
31341	9/16-12	3	H3	1
31351	9/16-18	3	H3	1
31361	5/8-11	3	H3	1

Part#	Size	# of Flutes	H Limits	Qty. per/pack
31371	5/8-18	3	H3	1
31381	3/4-10	3	H3	1
31391	3/4-16	3	H3	1
31401	7/8-9	3	H3	1
31411	7/8-14	3	H3	1
31421	1-8	3	H3	1
31431	1-14	3	H3	1

METRIC

Part#	Size	# of Flutes	PD Limits	Qty. per/pack
31441	3-.50	2	D3	3
31451	4-.70	3	D4	3
31461	5-.80	3	D4	3
31471	6-1.00	3	D5	3
31481	8-1.25	3	D5	3
31491	10-1.50	3	D6	3
31501	12-1.75	3	D6	1
31511	14-2.00	3	D7	1
31521	16-2.00	3	D7	1

TITANIUM ALUMINUM NITRIDE

TYPE 29-ALN

Part #	Size	# of Flutes	H Limits	Qty. per/pack
56301	2-56	2	H2	3
56311	3-48	2	H2	3
56321	4-40	2	H2	3
56331	4-48	2	H2	3
56341	5-40	2	H2	3
56351	5-44	2	H2	3
56361	6-32	3	H3	3
56371	6-40	3	H2	3
56381	8-32	2	H3	3
56391	8-32A	3	H3	3
56401	8-36	2	H2	3
56411	8-36A	3	H2	3
56421	10-24	2	H3	3
56431	10-24A	3	H3	3
56441	10-32	2	H3	3
56451	10-32A	3	H3	3
56461	12-24	2	H3	3
56471	12-24A	3	H3	3

Part #	Size	# of Flutes	H Limits	Qty. per/pack
56481	12-28	2	H3	3
56491	12-28A	3	H3	3
56501	1/4-20	2	H3	3
56511	1/4-20A	3	H3	3
56521	1/4-28	2	H3	3
56531	1/4-28A	3	H2	3
56541	5/16-18	2	H3	3
56551	5/16-18A	3	H3	3
56561	5/16-24	2	H3	3
56571	5/16-24A	3	H2	3
56581	3/8-16	3	H3	3
56591	3/8-24	3	H3	3
56601	7/16-14	3	H3	3
56611	7/16-20	3	H3	3
56621	1/2-13	3	H3	3
56631	1/2-20	3	H3	3
56641	9/16-12	3	H3	1
56651	9/16-18	3	H3	1
56661	5/8-11	3	H3	1

Part #	Size	# of Flutes	H Limits	Qty. per/pack
56671	5/8-18	3	H3	1
56681	3/4-10	3	H3	1
56691	3/4-16	3	H3	1
56701	7/8-9	3	H3	1
56711	7/8-14	3	H3	1
56721	1-8	3	H3	1
56731	1-14	3	H3	1

METRIC

Part#	Size	# of Flutes	PD Limits	Qty. per/pack
56741	3-.50	2	D3	3
56751	4-.70	3	D4	3
56761	5-.80	3	D4	3
56771	6-1.00	3	D5	3
56781	8-1.25	3	D5	3
56791	10-1.50	3	D6	3
56801	12-1.75	3	D6	3
56811	14-2.00	3	D7	1
56821	16-2.00	3	D7	1

HSS Taps



M42 COBALT TAPS

Type 24-RNC Bright Finish Type 24-RNCN TiN Coated Fractional - Taps for Hardened Steel and Iron

- M42 plug taps for tapping through holes in mold steel and hardened steel with Rockwell C hardness between C30 – C45.
- Titanium nitride M42 plug taps last twice as long as uncoated taps, titanium coatings lubricity produces smooth threads.
- For use in cast iron, brass, bronze, armor plate with a Rockwell C hardness between C30 – C45 and hard plastics

Part #	Titanium Nitride Part #	Thread Size	Thread Length	Overall Length	Shank Diameter	Drill Bit Size	# of Flutes	Pitch Limit Diameter	Qty Per Pack
10052	13802	4-40	5/16"	1-7/8"	0.1405	#43	3	H2	3
10072	13822	5-40	5/16"	1-15/16"	0.1405	#38	3	H2	3
10092	13842	6-32	3/8"	2"	0.1405	#36	3	H3	3
10112	13862	8-32	3/8"	2-1/8"	0.1675	#29	3	H3	3
10132	13882	10-24	1/2"	2-3/8"	0.1935	#25	3	H3	3
10142	13892	10-32	1/2"	2-3/8"	0.1935	#21	3	H3	3
10172	13922	1/4-20	5/8"	2-1/2"	0.2545	#7	3	H3	3
10182	13932	1/4-28	5/8"	2-1/2"	0.2545	#3	3	H3	3
10192	13942	5/16-18	11/16"	2-23/32"	0.3175	F	4	H3	3
10202	13952	5/16-24	11/16"	2-23/32"	0.3175	I	4	H3	3
10212	13962	3/8-16	3/4"	2-15/16"	0.3805	5/16"	4	H3	3
10222	13972	3/8-24	3/4"	2-15/16"	0.3805	Q	4	H3	3
10232	13982	7/16-14	7/8"	3-5/32"	0.3225	U	4	H3	3
10242	13992	7/16-20	7/8"	3-5/32"	0.3225	25/64"	4	H3	3
10272	14002	1/2-13	15/16"	3-3/8"	0.3665	27/64"	4	H3	3
10282	14012	1/2-20	15/16"	3-3/8"	0.3665	29/64"	4	H3	3
10292	14042	5/8-11	1-3/32"	3-13/16"	0.4795	17/32"	4	H3	1
10302	14052	5/8-18	1-3/32"	3-13/16"	0.4795	37/64"	4	H3	1
10312	14062	3/4-10	1-7/32"	4-1/4"	0.5895	21/32"	4	H3	1
10322	14072	3/4-16	1-7/32"	4-1/4"	0.5895	11/16"	4	H3	1

HSS STRAIGHT FLUTE HAND TAPS

Machine Screw / Fractional - Ground Thread

Types 23-UB, Type 24-UB & Type 25-UB Gold Oxide Types 23-UBN, Type 24-UBN & Type 25-UBN Titanium Nitride Types 23, Type 24 & Type 25 Bright Finish

- The most common style of tap
- Can be used by hand or for tapping under power
- Versatile taps for use in general machine tapping or CNC tapping applications
- Use for through hole or blind hole tapping.



Type 23-UB - Taper

Gold Oxide - low temperature stress relief that enhances lubricity, reduces friction and increases tap toughness.



Type 24-UBN - Plug

Titanium nitride - increases wear resistance by producing a higher surface hardness and exceptional lubricity resulting in longer tool life.



Type 25 - Bottoming Bright Finish

Red Bold = most common used Taps

23-UB Taper Part#	24-UB Plug Part #	25-UB Bottoming Part #	23-UBN Taper Part #	24-UBN Plug Part #	25-UBN Bottoming Part #	23 Taper Part #	24 Plug Part #	25 Bottoming Part #	# of Flutes	H Limit	QTY per/pack	
72701	72702	72703	45981	45982	45983	71661	71662	71663	0-80	2	H1	3
72711	72712	72713	45991	45992	45993	71671	71672	71673	0-80	2	H2	3
72721	72722	72723	44101	44102	44103	71681	71682	71683	1-64	2	H1	3
72731	72732	72733	44111	44112	44113	71691	71692	71693	1-64	2	H2	3
72741	72742	72743	44121	44122	44123	71701	71702	71703	1-72	2	H1	3
72751	72752	72753	44131	44132	44133	71711	71712	71713	1-72	2	H2	3
72761	72762	72763	44141	44142	44143	71721	71722	71723	2-56	3	H1	3
60660	60661	60662	46001	46002	46003	71231	71232	71233	2-56	3	H2	3
72771	72772	72773	44151	44152	44153	71731	71732	71733	2-64	3	H2	3
72781	72782	72783	44161	44162	44163	71741	71742	71743	3-48	3	H1	3
60680	60681	60682	46011	46012	46013	71251	71252	71253	3-48	3	H2	3
60710	60711	60712	45931	45932	45933	71751	71752	71753	3-56	3	H2	3
60700	60701	60702	46021	46022	46023	61001	61002	61003	4-40	3	H2	3
60720	60721	60722	45951	45952	45953	61011	61012	61013	4-48	3	H2	3
72791	72792	72793	44191	44192	44193	71761	71762	71763	5-40	3	H1	3
60730	60731	60732	46031	46032	46033	61021	61022	61023	5-40	3	H2	3
60740	60741	60742	45971	45972	45973	61031	61032	61033	5-44	3	H2	3
72801	72802	72803	44211	44212	44213	71771	71772	71773	6-32	3	H1	3
72811	72812	72813	44221	44222	44223	71781	71782	71783	6-32	3	H2	3
60750	60751	60752	46041	46042	46043	61041	61042	61043	6-32	3	H3	3
72821	72822	72823	44231	44232	44233	71791	71792	71793	6-40	3	H1	3
60760	60761	60762	46051	46052	46053	61051	61052	61053	6-40	3	H2	3
72831	72832	72833	44241	44242	44243	71801	71802	71803	8-32	4	H1	3
72841	72842	72843	44251	44252	44253	71811	71812	71813	8-32	4	H2	3
60770	60771	60772	46061	46062	46063	61061	61062	61063	8-32	4	H3	3
60780	60781	60782	46071	46072	46073	61071	61072	61073	8-36	4	H2	3
72851	72852	72853	44261	44262	44263	71821	71822	71823	10-24	4	H1	3

HSS STRAIGHT FLUTE HAND TAPS

Machine Screw / Fractional - Ground Thread - Ultra Bor Super Premium

Types 23-UB, Type 24-UB & Type 25-UB Gold Oxide
Types 23-UBN, Type 24-UBN & Type 25-UBN Titanium Nitride
Types 23, Type 24 & Type 25 Bright Finish

- The most common style of tap
- Can be used by hand or for tapping under power
- Versatile taps for use in general machine tapping or CNC tapping applications
- Use for through hole or blind hole tapping



Type 23-UB - Taper

Gold Oxide - low temperature stress relief that enhances lubricity, reduces friction and increases tap toughness.



Type 24-UBN - Plug

Titanium nitride- increases wear resistance by producing a higher surface hardness and exceptional lubricity resulting in longer tool life.



Type 25 - Bottoming
Bright Finish

Red Bold = most common used Taps

23-UB Taper Part#	24-UB Plug Part #	25-UB Bottoming Part #	23-UBN Taper Part #	24-UBN Plug Part #	25-UBN Bottoming Part #	23 Taper Part #	24 Plug Part #	25 Bottoming Part #	Size	# of Flutes	H Limit	QTY per/pack
72861	72862	72863	44271	44272	44273	71831	71832	71833	10-24	4	H2	3
60790	60791	60792	46081	46082	46083	61081	61082	61083	10-24	4	H3	3
72871	72872	72873	44281	44282	44283	71841	71842	71843	10-32	4	H1	3
72881	72882	72883	44291	44292	44293	71851	71852	71853	10-32	4	H2	3
60800	60801	60802	46091	46092	46093	61091	61092	61093	10-32	4	H3	3
60810	60811	60812	46101	46102	46103	61101	61102	61103	12-24	4	H3	3
60820	60821	60822	46111	46112	46113	61111	61112	61113	12-28	4	H3	3
72891	72892	72893	44301	44302	44303	71861	71862	71863	1/4-20	4	H1	3
72901	72902	72903	44311	44312	44313	71871	71872	71873	1/4-20	4	H2	3
60830	60831	60832	46121	46122	46123	61121	61122	61123	1/4-20	4	H3	3
72911	72912	72913	44321	44322	44323	71881	71882	71883	1/4-20	4	H5	3
72921	72922	72923	44331	44332	44333	71891	71892	71893	1/4-28	4	H1	3
72931	72932	72933	44341	44342	44343	71901	71902	71903	1/4-28	4	H2	3
60840	60841	60842	46131	46132	46133	61131	61132	61133	1/4-28	4	H3	3
72941	72942	72943	44351	44352	44353	71911	71912	71913	1/4-28	4	H4	3
72951	72952	72953	44361	44362	44363	71921	71922	71923	5/16-18	4	H2	3
60850	60851	60852	46141	46142	46143	61141	61142	61143	5/16-18	4	H3	3
72961	72962	72963	44371	44372	44373	71931	71932	71933	5/16-18	4	H5	3
72971	72972	72973	44381	44382	44383	71941	71942	71943	5/16-24	4	H2	3
60860	60861	60862	46151	46152	46153	61151	61152	61153	5/16-24	4	H3	3
72981	72982	72983	44391	44392	44393	71951	71952	71953	5/16-24	4	H4	3
72991	72992	72993	44401	44402	44403	71961	71962	71963	3/8-16	4	H1	3
73001	73002	73003	44411	44412	44413	71971	71972	71973	3/8-16	4	H2	3
60870	60871	60872	46161	46162	46163	61161	61162	61163	3/8-16	4	H3	3
73011	73012	73013	44421	44422	44423	71981	71982	71983	3/8-16	4	H5	3
73021	73022	73023	44431	44432	44433	71991	71992	71993	3/8-24	4	H1	3
73031	73032	73033	44441	44442	44443	72001	72002	72003	3/8-24	4	H2	3
60880	60881	60882	46171	46172	46173	61171	61172	61173	3/8-24	4	H3	3
73041	73042	73043	44451	44452	44453	72011	72012	72013	3/8-24	4	H4	3
60890	60891	60892	46181	46182	46183	61181	61182	61183	7/16-14	4	H3	3
73051	73052	73053	44461	44462	44463	72021	72022	72023	7/16-14	4	H5	3
60900	60901	60902	46191	46192	46193	61191	61192	61193	7/16-20	4	H3	3
73061	73062	73063	44471	44472	44473	72031	72032	72033	7/16-20	4	H5	3
73071	73072	73073	44481	44482	44483	72041	72042	72043	1/2-13	4	H1	3
60910	60911	60912	46201	46202	46203	61201	61202	61203	1/2-13	4	H3	3
73081	73082	73083	44491	44492	44493	72051	72052	72053	1/2-13	4	H5	3
73091	73092	73093	44501	44502	44503	72061	72062	72063	1/2-20	4	H1	3
60920	60921	60922	46211	46212	46213	61211	61212	61213	1/2-20	4	H3	3
73101	73102	73103	44511	44512	44513	72071	72072	72073	1/2-20	4	H5	3
60950	60951	60952	46221	46222	46223	55011	55012	55013	9/16-12	4	H3	1

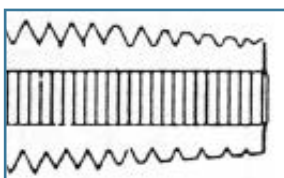

TAPER
Type 23-UB, 23-UBN, 23
Type 31-UB, 31-UBN, 31
 Eight to ten threads chamfered for easy thread starting in tough materials.

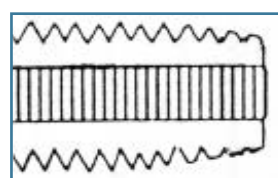

PLUG
Type 24-UB, 24-UBN, 24
Type 32-UB, 32-UBN, 32
 Three to five threads chamfered. For general use when tapping into the bottom of the hole is not critical. (This is the most widely used style.)

HSS STRAIGHT FLUTE HAND TAPS

Machine Screw / Fractional - Ground Thread - Ultra Bor Super Premium

- Types 23-UB, Type 24-UB & Type 25-UB Gold Oxide**
- Types 23-UBN, Type 24-UBN & Type 25-UBN Titanium Nitride**
- Types 23, Type 24 & Type 25 Bright Finish**

- The most common style of tap
- Can be used by hand or for tapping under power
- Versatile taps for use in general machine tapping or CNC tapping applications
- Use for through hole or blind hole tapping



Type 23-UB - Taper

Gold Oxide - low temperature stress relief that enhances lubricity, reduces friction and increases tap toughness.



Type 24-UBN - Plug

Titanium nitride - increases wear resistance by producing a higher surface hardness and exceptional lubricity resulting in longer tool life.



Type 25 - Bottoming
Bright Finish

Red Bold = most common used Taps

23-UB Taper Part#	24-UB Plug Part #	25-UB Bottoming Part #	23-UBN Taper Part #	24-UBN Plug Part #	25-UBN Bottoming Part #	23 Taper Part #	24 Plug Part #	25 Bottoming Part #	Size	# of Flutes	H Limit	QTY per/pack
73111	73112	73113	44521	44522	44523	72081	72082	72083	9/16-12	4	H5	1
73121	73122	73123	44531	44532	44533	72091	72092	72093	9/16-18	4	H2	1
60960	60961	60962	46231	46232	46233	55021	55022	55023	9/16-18	4	H3	1
73131	73132	73133	44541	44542	44543	72101	72102	72103	9/16-18	4	H5	1
73141	73142	73143	44551	44552	44553	72111	72112	72113	5/8-11	4	H2	1
60970	60971	60972	46241	46242	46243	55031	55032	55033	5/8-11	4	H3	1
73151	73152	73153	44561	44562	44563	72121	72122	72123	5/8-11	4	H5	1
73161	73162	73163	44571	44572	44573	72131	72132	72133	5/8-18	4	H2	1
60980	60981	60982	46251	46252	46253	55041	55042	55043	5/8-18	4	H3	1
73171	73172	73173	44581	44582	44583	72141	72142	72143	5/8-18	4	H5	1
73181	73182	73183	44591	44592	44593	72151	72152	72153	11/16-11	4	H3	1
73191	73192	73193	44601	44602	44603	72161	72162	72163	11/16-16	4	H3	1
60990	60991	60992	46261	46262	46263	55051	55052	55053	3/4-10	4	H3	1
73201	73202	73203	44611	44612	44613	72171	72172	72173	3/4-10	4	H5	1
73211	73212	73213	44621	44622	44623	72181	72182	72183	3/4-16	4	H1	1
73221	73222	73223	44631	44632	44633	72191	72192	72193	3/4-16	4	H2	1
61400	61401	61402	46271	46272	46273	55061	55062	55063	3/4-16	4	H3	1
73231	73232	73233	44641	44642	44643	72201	72202	72203	3/4-16	4	H5	1
61410	61411	61412	46281	46282	46283	55071	55072	55073	7/8-9	4	H4	1
73241	73242	73243	44651	44652	44653	72211	72212	72213	7/8-9	4	H6	1
73251	73252	73253	44661	44662	44663	72221	72222	72223	7/8-14	4	H2	1
61420	61421	61422	46291	46292	46293	55081	55082	55083	7/8-14	4	H4	1
73261	73262	73263	44671	44672	44673	72231	72232	72233	7/8-14	4	H6	1
61430	61431	61432	46301	46302	46303	55091	55092	55093	1"-8	4	H4	1
73271	73272	73273	44681	44682	44683	72241	72242	72243	1"-8	4	H6	1
61440	61441	61442	46311	46312	46313	55101	55102	55103	1"-12	4	H4	1
27570	27571	27572	46321	46322	46323	55111	55112	55113	1"-14	4	H4	1
61450	61451	61452	46331	46332	46333	55121	55122	55123	1" 1/8-7	4	H4	1
61460	61461	61462	46341	46342	46343	55131	55132	55133	1" 1/8-12	4	H4	1
61470	61471	61472	46351	46352	46353	55141	55142	55143	1" 1/4-7	4	H4	1
61480	61481	61482	46361	46362	46363	55151	55152	55153	1" 1/4-12	6	H4	1
61490	61491	61492	46371	46372	46373	55161	55162	55163	1" 3/8-6	4	H4	1
61500	61501	61502	46381	46382	46383	55171	55172	55173	1" 3/8-12	6	H4	1
61510	61511	61512	46391	46392	46393	55181	55182	55183	1" 1/2-6	4	H4	1
61520	61521	61522	46401	46402	46403	55191	55192	55193	1" 1/2-12	6	H4	1

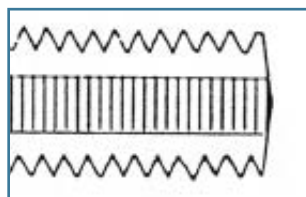

BOTTOMING

Type 25-UB, 25-UBN, 25 Type 33-UB, 33-UBN, 33

One-and - two threads chamfered. To use after threads have been started for tapping to the bottom of a hole.

STRAIGHT FLUTES HAND TAPS & TITANIUM NITRIDE SETS

Types 26-UB, Types 26-UBN & Type 26 Sets

- Includes one each Taper, Plug and Bottoming

Straight Flute Hand Taps Machine Screw / Fractional - Taper, Plug, Bottoming Ground Thread - High Speed Steel



- The most common style of tap
- Can be used by hand or for tapping under power
- Versatile taps for use in general machine tapping or CNC tapping applications
- Use for through hole or blind hole tapping

Type 26-UB - Gold Oxide

Gold Oxide - low temperature stress relief that enhances lubricity, reduces friction and increases tap toughness.

Type 26-UBN - Titanium Nitride

Titanium nitride increases wear resistance by producing a higher surface hardness and exceptional lubricity resulting in longer tool life.

Type 26 - Bright Finish

26-UB Gold Oxide Part #	26-UBN Titanium Nitride Part #	Type 26 Bright Part #	Size	# of Flutes	H Limit	Qty. per/pack each
60663	46004	71724	2-56	3	H2	1
60683	46014	71744	3-48	3	H2	1
60703	46024	61004	4-40	3	H2	1
60723	45954	61014	4-48	3	H2	1
60733	46034	61024	5-40	3	H2	1
60743	45974	61034	5-44	3	H2	1
60753	46044	61044	6-32	3	H3	1
60763	46054	61054	6-40	3	H2	1
60773	46064	61064	8-32	4	H3	1
60783	46074	61074	8-36	4	H2	1
60793	46084	61084	10-24	4	H3	1
60803	46094	61094	10-32	4	H3	1
60813	46104	61104	12-24	4	H3	1
60823	46114	61114	12-28	4	H3	1
60833	46124	61124	1/4-20	4	H3	1
60843	46134	61134	1/4-28	4	H3	1
60853	46144	61144	5/16-18	4	H3	1
60863	46154	61154	5/16-24	4	H3	1
60873	46164	61164	3/8-16	4	H3	1
60883	46174	61174	3/8-24	4	H3	1
60893	46184	61184	7/16-14	4	H3	1
60903	46194	61194	7/16-20	4	H3	1
60913	46204	61204	1/2-13	4	H3	1
60923	46214	61214	1/2-20	4	H3	1
60953	46224	55014	9/16-12	4	H3	1
60963	46234	55024	9/16-18	4	H3	1
60973	46244	55034	5/8-11	4	H3	1
60983	46254	55044	5/8-18	4	H3	1
60993	46264	55054	3/4-10	4	H3	1
61403	46274	55064	3/4-16	4	H3	1
61413	46284	55074	7/8-9	4	H4	1
61423	46294	55084	7/8-14	4	H4	1
61433	46304	55094	1"-8	4	H4	1
61443	46314	55104	1"-12	4	H4	1
27573	46324	55114	1"-14	4	H4	1
61453	46334	55124	1 1/8-7	4	H4	1
61463	46344	55134	1 1/8-12	4	H4	1
61473	46354	55144	1 1/4-7	4	H4	1
61483	46364	55154	1 1/4-12	6	H4	1
61493	46374	55164	1 3/8-6	4	H4	1
61503	46384	55174	1 3/8-12	6	H4	1
61513	46394	55184	1 1/2-6	4	H4	1
61523	46404	55194	1 1/2-12	6	H4	1

HSS Taps - Straight Flute Hand Tap Sets

METRIC - STRAIGHT FLUTE HAND TAPS

Straight Flute Hand Taps - Gold Oxide Ground Thread - High Speed Steel

Type 31-UB, 31-UBN, 31 -Taper, Type 32-UB, 32-UBN, 32 -Plug Type 33-UB, 33-UBN, 33 -Bottoming

- The most common style of tap.
- Can be used by hand or for tapping under power.
- Versatile taps for use in general machine tapping or CNC tapping applications.
- Use for through hole or blind hole tapping.



Type 31-UB - Taper

Gold Oxide - low temperature stress relief that enhances lubricity, reduces friction and increases tap toughness.



Type 32-UBN - Plug

Titanium nitride - increases wear resistance by producing a higher surface hardness and exceptional lubricity resulting in longer tool life.



Type 33 - Bottoming
Bright Finish

METRIC

HSS Taps - Metric Straight Flute & Titanium Nitride Taps

31-UB Taper Part #	32-UB Plug Part #	33-UB Bottoming Part #	31-UBN Taper Part #	32-UBN Plug Part #	33-UBN Bottoming Part #	31 Taper Part #	32 Plug Part #	33 Bottoming Part #	Size	# of Flutes	PD Limit	QTY. per/pack
60329	61569	61561	-----	-----	-----	54691	54692	54693	1.6-0.35	2	D3	3
60339	61579	61571	-----	-----	-----	54701	54702	54703	1.8-0.35	2	D3	3
60349	61589	61581	-----	-----	-----	54711	54712	54713	2.0-0.40	3	D3	3
60359	61599	61591	-----	-----	-----	54721	54722	54723	2.2-0.45	3	D3	3
60379	61629	61681	37731	37732	37733	54731	54732	54733	2.5-0.45	3	D3	3
60389	61631	61682	37741	37742	37743	54741	54742	54743	3.0-0.50	3	D3	3
60519	61632	61683	37751	37752	37753	54751	54752	54753	3.5-0.60	3	D4	3
60529	61633	61684	37761	37762	37763	54761	54762	54763	4.0-0.70	4	D4	3
60369	61634	61689	37771	37772	37773	54771	54772	54773	4.5-0.75	4	D4	3
60539	61639	61691	37781	37782	37783	54781	54782	54783	5.0-0.80	4	D4	3
60549	61641	61692	37791	37792	37793	54791	54792	54793	6.0-1.00	4	D5	3
60559	61642	61693	37801	37802	37803	54801	54802	54803	7.0-1.00	4	D5	3
60569	61643	61694	37811	37812	37813	54811	54812	54813	8.0-1.00	4	D5	3
60579	61644	61699	37821	37822	37823	54821	54822	54823	8.0-1.25	4	D5	3
60589	61649	61701	37831	37832	37833	54831	54832	54833	10.0-1.25	4	D5	3
60611	61651	61702	37841	37842	37843	54841	54842	54843	10.0-1.50	4	D6	3
61601	61652	61703	37851	37852	37853	54851	54852	54853	12.0-1.25	4	D5	3
61901	61911	61921	38451	38452	38453	55201	55202	55203	12.0-1.50	4	D6	3
61602	61653	61704	37861	37862	37863	54861	54862	54863	12.0-1.75	4	D6	3
61603	61654	61709	37871	37872	37873	54871	54872	54873	14.0-1.50	4	D6	1
61604	61659	61711	37881	37882	37883	54881	54882	54883	14.0-2.00	4	D7	1
61609	61661	61712	37891	37892	37893	54891	54892	54893	16.0-1.50	4	D6	1
61611	61662	61713	37901	37902	37903	54901	54902	54903	16.0-2.00	4	D7	1
61281	61282	61283	38491	38492	38493	54911	54912	54913	18.0-1.50	4	D6	1
61612	61663	61714	37911	37912	37913	54921	54922	54923	18.0-2.50	4	D7	1
66361	66362	66363	38501	38502	38503	55251	55252	55253	20.0-1.50	4	D6	1
61613	61664	61719	37921	37922	37923	54931	54932	54933	20.0-2.50	4	D7	1
66371	66372	66373	38521	38522	38523	55261	55262	55263	22.0-1.50	4	D6	1
66381	66382	66383	38531	38532	38533	55271	55272	55273	22.0-2.50	4	D7	1
66391	66392	66393	38541	38542	38543	55281	55282	55283	24.0-2.00	4	D7	1
61614	61669	61721	37931	37932	37933	54941	54942	54943	24.0-3.00	4	D8	1
66401	66402	66403	-----	-----	-----	55291	55292	55293	27.0-2.00	4	D7	1
61619	61671	61722	-----	-----	-----	54951	54952	54953	27.0-3.00	4	D8	1
66411	66412	66413	-----	-----	-----	55301	55302	55303	30.0-2.00	4	D7	1
61621	61672	61723	-----	-----	-----	54961	54962	54963	30.0-3.50	4	D9	1
66421	66422	66423	-----	-----	-----	55311	55312	55313	33.0-2.00	6	D7	1
61622	61673	61724	-----	-----	-----	54971	54972	54973	33.0-3.50	4	D9	1
66431	66432	66433	-----	-----	-----	55321	55322	55323	36.0-3.00	4	D8	1
61623	61674	61729	-----	-----	-----	54981	54982	54983	36.0-4.00	4	D9	1
66441	66442	66443	-----	-----	-----	55331	55332	55333	39.0-3.00	6	D8	1
61624	61679	61731	-----	-----	-----	54991	54992	54993	39.0-4.00	6	D9	1

PRODUCT TIPS

Tap Wrenches:

They come in two sizes, large & small. Make sure tap is securely locked in place by turning the hex head as tightly as possible with your fingers. Do not use a wrench to tighten.



Taper Tap

This section cuts full-size thread



Plug Tap

This section cuts full-size thread



Bottoming Tap

This section cuts full-size thread

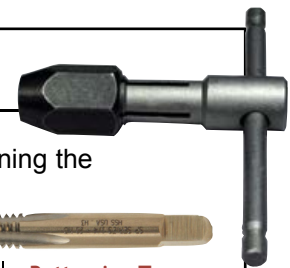

STRAIGHT FLUTE HAND TAP SETS & TAPER PIPE TAPS

Type 35-UB, 35-UBN & Type 35 Sets Straight Flute Hand Taps - Taper, Plug, Bottoming Ground Thread - High Speed Steel

- The most common style of tap
- Can be used by hand or for tapping under power
- Versatile taps for use in general machine tapping or CNC tapping applications
- Use for through hole or blind hole tapping

Type 35-UB - Gold Oxide
Gold Oxide - low temperature stress relief that enhances lubricity, reduces friction and increases tap toughness.

Type 35-UBN - Titanium Nitride
Titanium nitride increases wear resistance by producing a higher surface hardness and exceptional lubricity resulting in longer tool life.

Type 35 - Bright Finish

(Includes one each Taper, Plug and Bottoming tap)

35-UB Gold Oxide Part #	35-UBN Titanium Nitride Part #	Type 35 Bright Part #	Size	# of Flutes	PD Limit	Qty per/pk
61741	37744	54744	3.0-0.50	3	D3	1
61742	37764	54764	4.0-0.70	4	D4	1
61743	37784	54784	5.0-0.80	4	D4	1
61744	37794	54794	6.0-1.00	4	D5	1
61749	37804	54804	7.0-1.00	4	D5	1
61751	37814	54814	8.0-1.00	4	D5	1
61752	37824	54824	8.0-1.25	4	D5	1
61753	37834	54834	10.0-1.25	4	D5	1
61754	37844	54844	10.0-1.50	4	D6	1
61759	37854	54854	12.0-1.25	4	D5	1
61761	37864	54864	12.0-1.75	4	D6	1
61762	37874	54874	14.0-1.50	4	D6	1
61763	37884	54884	14.0-2.00	4	D7	1
61764	37894	54894	16.0-1.50	4	D6	1
61769	37904	54904	16.0-2.00	4	D7	1
61772	37914	54924	18.0-2.50	4	D7	1
61774	37924	54934	20.0-2.50	4	D7	1

TAPER PIPE TAPS

Regular - Type 30-UB, 30-UBN, 30-B & 30

Interrupted - Type I30-UB, I30-UBN, I30-B & I30

- **Regular** Thread NPT Taper Pipe taps are used for tapping pipe fittings and couplings in a wide variety of materials.
- **Interrupted** Thread Taper Pipe taps reduce friction, increase chip capacity, and enhance coolant flow. **Recommended** for a wide variety of materials including soft ductile materials that produce long stringy chips. (*Black Oxide Taper Pipe Tap used on Cast Iron)

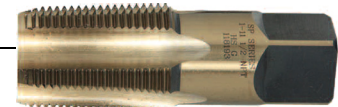

Type 30-UB



Type I-30-UB Interrupted

NPT INTERRUPTED

30-UB Gold Oxide Part #	30-UBN TiN Coated Part #	Type 30-B Black Part #	Type 30 Bright Part #	I30-UB Gold Oxide Part #	I30-UBN TiN Coated Part #	*I30-B Black Oxide Part #	Type I30 Bright Part #	Size NPT	# of Flutes	OAL	Shank Diameter	Tap Drill Size	QTY. per/pack
60570	59343	59342	59341	-----	-----	-----	-----	1/16-27	4	2-1/8	.3125	D	3
61240	59353	59352	59351	-----	-----	-----	-----	1/8-27 (5/16 Shk)	4	2-1/8	.3125	11/32	3
61250	59363	59362	59361	81410	95722	95771	95770	1/8-27	4	2-1/8	.4375	11/32	3
61260	59373	59372	59371	81420	95782	95781	95780	1/4-18	4	2-7/16	.5625	7/16	3
61270	59383	59382	59381	81430	95792	95791	95790	3/8-18	4	2-9/16	.7000	37/64	1
61280	59393	59392	59391	81440	95802	95801	95800	1/2-14	4	3-1/8	.6875	23/32	1
61290	59403	59402	59401	81450	95812	95811	95810	3/4-14	5	3-1/4	.9063	59/64	1
61300	59413	59412	59411	81460	95822	95821	95820	1"-11 1/2	5	3-3/4	1.1250	1-5/32	1
61310	59423	59422	59421	81470	95832	95831	95830	1 1/4"-11 1/2	5	4	1.3125	1-1/2	1
61320	59433	59432	59431	81480	95842	95841	95840	1 1/2"-11 1/2	7	4-1/4	1.500	1-47/64	1
61330	59443	59442	59441	81490	95852	95851	95850	2"-11 1/2	7	4-1/2	1.8750	2-7/32	1

METRIC

Taps - Straight Flute Hand Tap Sets & TiN Coated / Taper Pipe Taps

STRAIGHT FLUTE TAPS - LEFT HAND THREAD

Type 23L-UB -Taper , Type 24L-UB -Plug , Type 25L-UB -Bottoming

- Special Hi-Tungsten and Hi-Molybdenum tool steels, gold surface treated for maximum lubricity.
- Taper, plug and bottoming styles provide great versatility in tough materials, both blind and through holes.
- For general use in production tapping or left hand tapping operations.



TYPE 23L-UB TAPER STYLE LEFT HAND THREAD

Part No.	Size	Number of Flutes	GH Limit	Qty. per/pack
60223	6-32	3	3	3
60243	8-32	4	3	3
60263	10-24	4	3	3
60273	10-32	4	3	3
60323	1/4-20	4	3	3
60333	1/4-28	4	3	3
60343	5/16-18	4	3	3
60353	5/16-24	4	3	3
60363	3/8-16	4	3	3
60373	3/8-24	4	3	3
60383	7/16-14	4	3	3
60393	7/16-20	4	3	3
60403	1/2-13	4	3	3
60413	1/2-20	4	3	3
60423	9/16-12	4	3	1
60433	9/16-18	4	3	1
60443	5/8-11	4	3	1
60453	5/8-18	4	3	1
60463	11/16-11	4	3	1
60473	11/16-16	4	3	1
60483	3/4-10	4	3	1
60493	3/4-16	4	3	1
60503	7/8-9	4	4	1
60513	7/8-14	4	4	1
60523	1-8	4	4	1
60533	1-12	4	4	1
60543	1-14	4	4	1
60553	1-1/8-7	4	4	1
60563	1-1/8-12	4	4	1
60573	1-1/4-7	4	4	1
60583	1-1/4-12	6	4	1
60593	1-3/8-6	4	4	1
60603	1-3/8-12	6	4	1
60613	1-1/2-6	6	4	1
60609	1-1/2-12	4	4	1

TYPE 24L-UB PLUG STYLE LEFT HAND THREAD

Part No.	Size	Number of Flutes	GH Limit	Qty. per/pack
60222	6-32	3	3	3
60242	8-32	4	3	3
60262	10-24	4	3	3
60272	10-32	4	3	3
60322	1/4-20	4	3	3
60332	1/4-28	4	3	3
60342	5/16-18	4	3	3
60352	5/16-24	4	3	3
60362	3/8-16	4	3	3
60372	3/8-24	4	3	3
60382	7/16-14	4	3	3
60392	7/16-20	4	3	3
60402	1/2-13	4	3	3
60412	1/2-20	4	3	3
60422	9/16-12	4	3	1
60432	9/16-18	4	3	1
60442	5/8-11	4	3	1
60452	5/8-18	4	3	1
60462	11/16-11	4	3	1
60472	11/16-16	4	3	1
60482	3/4-10	4	3	1
60492	3/4-16	4	3	1
60502	7/8-9	4	4	1
60512	7/8-14	4	4	1
60522	1-8	4	4	1
60532	1-12	4	4	1
60542	1-14	4	4	1
60552	1-1/8-7	4	4	1
60562	1-1/8-12	4	4	1
60572	1-1/4-7	4	4	1
60582	1-1/4-12	6	4	1
60592	1-3/8-6	4	4	1
60602	1-3/8-12	6	4	1
60612	1-1/2-6	4	4	1
60619	1-1/2-12	6	4	1



TYPE 25L-UB BOTTOMING LEFT HAND THREAD

Part No.	Size	Number of Flutes	GH Limit	Qty. per/pack	Part No.	Size	Number of Flutes	GH Limit	Qty. per/pack	Part No.	Size	Number of Flutes	GH Limit	Qty. per/pack
60224	6-32	3	3	3	60404	1/2-13	4	3	3	60524	1-8	4	4	1
60244	8-32	4	3	3	60414	1/2-20	4	3	3	60534	1-12	4	4	1
60264	10-24	4	3	3	60424	9/16-12	4	3	1	60544	1-14	4	4	1
60274	10-32	4	3	3	60434	9/16-18	4	3	1	60554	1-1/8-7	4	4	1
60324	1/4-20	4	3	3	60444	5/8-11	4	3	1	60564	1-1/8-12	4	4	1
60334	1/4-28	4	3	3	60454	5/8-18	4	3	1	60574	1-1/4-7	4	4	1
60344	5/16-18	4	3	3	60464	11/16-11	4	3	1	60584	1-1/4-12	6	4	1
60354	5/16-24	4	3	3	60474	11/16-16	4	3	1	60594	1-3/8-6	4	4	1
60364	3/8-16	4	3	3	60484	3/4-10	4	3	1	60604	1-3/8-12	6	4	1
60374	3/8-24	4	3	3	60494	3/4-16	4	3	1	60614	1-1/2-6	6	4	1
60384	7/16-14	4	3	3	60504	7/8-9	4	4	1	60599	1-1/2-12	4	4	1
60394	7/16-20	4	3	3	60514	7/8-14	4	4	1					

TAP & DRILL COMBO & SETS

Ultra Bor Super Premium

Includes corresponding drill with tap in a durable metal case.



TAP & DRILL SETS

SP-18TD (SPIRAL POINT, NC)

Part# 57580 **Description of Sizes**

240-UB Drill Sizes	#36, 29, 25, 21, 7, F, 5/16, U & 27/64
20-UB Tap Sizes	6-32, 8-32, 10-24, 10-32, 1/4-20, 7/16-18, 3/8-16, 7/16-14 & 1/2-13

SP-18TDM (SPIRAL POINT, METRIC)

Part# 57990 **Description of Sizes**

643-UB Drill Sizes (mm)	2.05, 2.50, 2.90, 3.30, 4.20, 5.00, 6.70, 8.50 & 10.20
21-UB Tap Sizes (mm)	2.5-.45, 3.0-.50, 3.5-.60, 4.0-.70, 5.0-.80, 6.0-1.00, 8.0-1.25, 10.0-1.50 & 12.0-1.75

SP-18TDF (SPIRAL POINT, NF)

Part# 58010 **Description of Sizes**

240-UB Drill Sizes	#33, 29, 25, 21, 3, 1, Q, 25/64 & 29/64
20-UB Tap Sizes	6-40, 8-36, 10-24, 10-32, 1/4-28, 5/16-24, 3/8-24, 7/16-20 & 1/2-20

SP-12TD (SPIRAL POINT, NC)

Part# 58501 **Description of Sizes**

240-UB Drill Sizes	#36, 29, 25, 21, 7, F
20-UB Tap Sizes	6-32, 8-32, 10-24, 10-32, 1/4-20 & 5/16-18

SF-18TDC (STRAIGHT FLUTE, NC)

Part# 60930 **Description of Sizes**

240-UB Drill Sizes	#36, 29, 25, 21, 7, F, 5/16, U & 27/64
24-UB Tap Sizes	6-32, 8-32, 10-24, 10-32, 1/4-20, 5/16-18, 3/8-16, 7/16-14 & 1/2-13

SF-18TDF (STRAIGHT FLUTE, NF)

Part# 60940 **Description of Sizes**

240-UB Drill Sizes	#33, 29, 25, 21, 3, 1, Q, 25/64 & 29/64
24-UB Tap Sizes	6-40, 8-36, 10-24, 10-32, 1/4-28, 5/16-24, 3/8-24, 7/16-20 & 1/2-20

SF-10TD (STRAIGHT FLUTE, NC)

Part# 58500 **Description of Sizes**

240-UB Drill Sizes	31/64
280-UB Drill Sizes	17/32, 21/32, 49/64 & 7/8
24-UB Tap Sizes	9/16-12, 5/8-11, 3/4-10, 7/8-9 & 1-8

DRILL & TAP COMBO

Type 34-UB

- Includes the correct drill with corresponding size tap on a hanging card.
- Both tools are gold surface treated for maximum lubricity, and precision ground for the ultimate in accuracy and performance.
- Hi-Molybdenum super premium twist drill combined with the corresponding Hi-Tungsten Magnum spiral point tap.

Part No.	Thread Size	Drill Size	Part No.	Thread Size	Drill Size
51807	6-32	36	51897	1/4-28	3
51817	6-40	33	51907	5/16-18	F
51827	8-32	29	51917	5/16-24	I
51837	8-36	29	51927	3/8-16	5/16
51847	10-24	25	51937	3/8-24	Q
51857	10-32	21	51947	7/16-14	U
51867	12-24	16	51957	7/16-20	25/64
51877	12-28	14	51967	1/2-13	27/64
51887	1/4-20	7	51977	1/2-20	29/64

Carded Hanging Display page 66

COMBINATION DRILL & TAP

Type 40-UB



- Hi-Molybdenum tool steel ensures longer tool life.
- Combination drill and taps are ideally suited for on-site tapping in construction, maintenance and repair, assembly, production environments.
- The self-centering split point provides excellent drilling precision and accuracy.



Pitch Diameter and Thread tolerances are designed to produce a Class 2B fit.

Part #	Size	Max Material Thickness	Thread Length
73770	4-40	0.368	0.564
73780	4-48	0.369	0.564
73790	5-40	0.403	0.624
73800	5-44	0.404	0.624
73810	6-32	0.468	0.376
73820	6-40	0.470	0.376
73830	8-32	0.539	0.376
73840	8-36	0.540	0.376
73850	10-24	0.606	0.496
73860	10-32	0.608	0.496
73870	12-24	0.677	0.496
73880	12-28	0.678	0.496
73890	1/4-20	0.746	0.626
73900	1/4-28	0.750	0.626
73910	5/16-18	0.889	0.683
73920	5/16-24	0.893	0.683
73930	3/8-16	1.031	0.746
73940	3/8-24	1.036	0.746
73950	7/16-14	1.172	0.882
73960	7/16-20	1.178	0.880
73970	1/2-13	1.378	0.940
73980	1/2-20	1.384	0.940
75540	9/16-12	1.395	0.940
75550	9/16-18	1.403	0.940
75560	5/8-11	1.412	0.940
75570	5/8-18	1.421	0.940

Pitch Diameter and Thread tolerances are designed to produce a Class 6H fit.

Part #	MM Size	Max Material Thickness	Thread Length
85921	3.0 x 0.5	0.403	0.624
85931	4.0 x 0.7	0.538	0.376
85941	5.0 x 0.8	0.610	0.496
85951	6.0 x 1.00	0.746	0.626
85961	7.0 x 1.00	0.882	0.686
85971	8.0 x 1.25	0.892	0.686
85991	10.0 x 1.50	1.037	0.746
86001	12.0 x 1.75	1.373	0.942

Part#	SETS	Description of Sizes
21330	40-UB - DT-6	6pc. set 6-32, 8-32, 10-24, 10-32, 12-24, 1/4-20
73991	40-UB - DT-7F	7pc. set Fine 8-36, 10-32, 1/4-28, 5/16-24, 3/8-24, 7/16-20, 1/2-20
73990	40-UB - DT-7C	7pc. set Coarse 8-32, 10-24, 1/4-20, 5/16-18, 3/8-16, 7/16-14, 1/2-13

1/4" QUICK RELEASE DRILL & TAP COMBO

Type 40-QR



- Hi-Molybdenum tool steel ensures longer tool life.
- Combination drill and taps are ideally suited for on-site tapping in construction, maintenance and repair, assembly, production environments.



Pitch Diameter and Thread tolerances are designed to produce a Class 2B fit.

Part#	Size	Max Material Thickness	Thread Length
73814	6-32	0.170	0.283
73834	8-32	0.200	0.283
73854	10-24	0.200	0.363
73864	10-32	0.200	0.363
73874	12-24	0.200	0.369
73894	1/4-20	0.230	0.326
73904	1/4-28	0.230	0.326
73914	5/16-18	0.480	0.614
73934	3/8-16	0.480	0.585

Pitch Diameter and Thread tolerances are designed to produce a Class 6H fit.

Part #	MM Size	Max Material Thickness	Thread Length
85924	3.0 x 0.50	0.170	0.334
85934	4.0 x 0.70	0.170	0.269
85944	5.0 x 0.80	0.200	0.404
85954	6.0 x 1.00	0.230	0.376
85974	8.0 x 1.25	0.480	0.638
85994	10.0 x 1.50	0.480	0.595

Part#	SETS	Description of Sizes
21324	40-QR DT-5	5pc. set 6-32, 8-32, 10-24, 10-32, 1/4-20

HSS Taps & Dies



HSS TAP SETS, HEX DIES - METRIC & CARDED HANGING DISPLAY

Carded Hanging Display

38 Piece MRO Pro-Pack Drilling & Tapping Combo Carded Super Premium Black & Gold Twist Drill combined with the Corresponding Hi-Tungsten Spiral Point Gold Tap.

Part No. 52001

One Each of	Two Each of	Three Each of	Four Each of
6-32	8-32	5/16-18	1/4-20
6-40	8-36	3/8-16	
12-24	10-24	7/16-14	
12-28	10-32	1/2-13	
	1/4-28		
	5/16-24		
	3/8-24		
	7/16-20		
	1/2-20		

HSS TAP SETS - METRIC

Magnum Super Premium

- Straight flute or spiral point taps in rugged black steel index.



SPIRAL & STRAIGHT FLUTE TAP SETS

SP-19T - Type 20-UB - Spiral Point

Part No.	Sizes
61600	0-80, 1-64, 1-72, 2-56, 2-64, 3-48, 3-56, 4-40, 4-48, 5-40, 5-44, 6-32, 6-40, 8-32, 8-36, 10-24, 10-32, 12-24 & 12-28

SP-10T - Type 20-UB - Spiral Point

Part No.	Sizes
61610	1/4-20, 1/4-28, 5/16-18, 5/16-24, 3/8-16, 3/8-24, 7/16-14, 7/16-20, 1/2-13 & 1/2-20

SF-10T - Type 24-UB - Straight Flute

Part No.	Sizes
61620	1/4-20, 1/4-28, 5/16-18, 5/16-24, 3/8-16, 3/8-24, 7/16-14, 7/16-20, 1/2-13 & 1/2-20

12pc. Drill, Tap & Countersink Set Type TDC-12



Part No.	Sizes
20470	Type 240-UB: Wire:#7, 21, 25, 29 and 36 Type 20-UB: 6-32, 8/32, 10-24, 10-32 and 1/4-20 Type 82-UB: No. 8 screw size and 3/16-17/32 range cut

HIGH-SPEED STEEL HEX DIES

Type 27-UB

Ultra Bor Super Premium Dies

- Special Hi-Molybdenum tool steel, polished gold finish with black surface treated threads for long life and rich appearance.
- These dies are used for threading rods, bolts, studs and other pieces requiring external threads.
- The outside hex configuration allows both wrench and die stock use in threading.



Part No.	Size	Across Flats	Qty. per/pack
61000	4-40	1"	3
61010	6-32	1"	3
61020	8-32	1"	3
61030	10-24	1"	3
61040	10-32	1"	3
61050	12-24	1"	3
61060	1/4-20	1"	3
61070	1/4-28	1"	3
61080	5/16-18	1"	3
61090	5/16-24	1"	3
61100	3/8-16	1"	3
61110	3/8-24	1"	3
61120	7/16-14	1"	3
61130	7/16-20	1"	3
61140	1/2-13	1"	3
61150	1/2-20	1"	3
61160	9/16-12	1-7/16"	1
61170	9/16-18	1-7/16"	1
61180	5/8-11	1-7/16"	1
61190	5/8-18	1-7/16"	1
61200	3/4-10	1-7/16"	1
61210	3/4-16	1-7/16"	1
61220	1/8-27	1"	1
61230	1/4-18	1-7/16"	1

METRIC

Part No.	Size	Across Flats	Qty. per/pack
60511	3.0 x 0.50	1"	3
60521	3.5 x 0.60	1"	3
60531	4.0 x 0.70	1"	3
60551	5.0 x 0.80	1"	3
60561	6.0 x 1.00	1"	3
60581	8.0 x 1.25	1"	3
60601	10.0 x 1.50	1"	3
60621	12.0 x 1.75	1-7/16"	1
60622	14.0 x 1.50	1-7/16"	1

25PC / 23PC / 15PC / 14PC HSS TAP & DIE ASSORTMENTS

25pc. Ultra Bor Super Premium Set Spiral Point Plug Taps & Hex Dies

Set contains:

- HSS spiral point taps & HSS hex dies sizes: 1/4-20, 1/4-28, 5/16-18, 5/16-24, 3/8-16, 3/8-24, 7/16-14, 7/16-20, 1/2-13 & 1/2-20.
 - HSS pipe tap and hex die size: 1/8-27 NPT.
 - T-Handle tap wrench: 3/16"-1/2".
 - Die stock & Screw pitch gauge.
 - SP-25TDI
- Supplied in sturdy plastic case.*

PART NO. 35173



Part # 35173

23pc. Ultra Bor Super Premium Set - METRIC Spiral Point Taps & Hex Dies

Set contains:

- HSS spiral point taps & HSS hex dies sizes: 3.0-.50, 3.5-.60, 4.0-.70, 5.0-.80, 6.0-1.00, 8.0-1.25, 10.0-1.50 & 12.0-1.75.
 - HSS pipe tap and hex die size: 1/8-27 NPT.
 - T-Handle tap wrenches: 0 - 1/4" & 3/16"-1/2".
 - Straight handle tap wrench: #4 - 1/2".
 - Die stock & Screw metric pitch gauge.
 - SP-23TDI
- Supplied in sturdy plastic case.*

PART NO. 35170

15pc. Ultra Bor Super Premium Set Spiral Point Plug Taps & Hex Dies

Set contains:

- HSS spiral point taps & HSS hex dies sizes: 6-32, 8-32, 10-24, 10-32, 12-24 & 1/4-20.
 - T-Handle tap wrench: 0 - 1/4".
 - Economy die stock & Screw pitch gauge.
 - SP-15TDI
- Supplied in sturdy plastic case.*

PART NO. 35174

14pc. Ultra Bor Super Premium Set - Metric Spiral Point Taps & Hex Dies

Set contains:

- HSS spiral point taps sizes: 2.5-.45, 3.0-.50, 3.5-.60, 4.0-.70, 5.0-.80 & 6.0-1.00.
- HSS hex dies sizes: 3.0-.50, 3.5-.60, 4.0-.70, 5.0-.80 & 6.0-1.00.
- T-Handle tap wrench: 0 - 1/4".
- SP-14TDI

*Economy die stock & Screw metric pitch gauge.
Supplied in sturdy plastic case.*

PART NO. 35172

HSS Taps & Dies



58 PCS & 40 PCS HSS TAPS & DIE ASSORTMENTS

- Special Hi-Tungsten and Hi -Molybdenum tool steels, gold surface treated for maximum lubricity.
- Recommended for use in production tapping and drilling in work hardening grades of stainless steel and other hard metal applications.
- Precision ground tap threads for the ultimate in accuracy and performance.



Part # 61680

58pc. Ultra Bor Super Premium Set Straight Flute Plug Taps & Hex Dies

Set contains:

- HSS straight flute taps & HSS hex dies sizes: 6-32, 8-32, 10-24, 10-32, 12-24, 1/4-20, 1/4-28, 5/16-18, 5/16-24, 3/8-16, 3/8-24, 7/16-14, 7/16-20, 1/2-13, 1/2-20, 9/16-12, 9/16-18, 5/8-11, 5/8-18, 3/4-10, 3/4-16, 1/8-27NPT & 1/4-18NPT.
- Straight handle tap wrenches: #4-1/2" & 1/4"-3/4".
 - Die stocks: MED R/H & 1"R/H.
 - T-handle tap wrench: 0-1/4".
 - Screw pitch gauge.
- Screw driver & Spiral flute extractors sizes: Ex 1 thru Ex 5.
 - SF-58TDI

Supplied in sturdy plastic case.

PART NO. 61680

40pc. Ultra Bor Super Premium Set Straight Flute Plug Taps & Hex Dies

Set contains:

- HSS straight flute taps & HSS hex dies sizes: 4-40, 6-32, 8-32, 10-24, 10-32, 12-24, 1/4-20, 1/4-28, 5/16-18, 5/16-24, 3/8-16, 3/8-24, 7/16-14, 7/16-20, 1/2-13 & 1/2-20.
 - HSS pipe tap and hex die size: 1/8-27 NPT.
- T-Handle tap wrenches: 0 - 1/4" & 3/16"-1/2".
 - Straight handle tap wrench: #4 - 1/2".
- Die stock, Screw pitch gauge & Screw driver.
 - SF-40TDI

Supplied in sturdy plastic case.

PART NO. 35171



Part # 35171

40pc. Ultra Bor Super Premium Set Spiral Point Plug Taps & Hex Dies

Set contains:

- HSS spiral point taps & HSS hex dies sizes: 4-40, 6-32, 8-32, 10-24, 10-32, 12-24, 1/4-20, 1/4-28, 5/16-18, 5/16-24, 3/8-16, 3/8-24, 7/16-14, 7/16-20, 1/2-13 & 1/2-20.
 - HSS pipe tap and hex die size: 1/8-27 NPT.
- T-Handle tap wrenches: 0 - 1/4" & 3/16"-1/2".
 - Straight handle tap wrench: #4 - 1/2".
- Die stock, Screw pitch gauge & Screw driver.
 - SP-40TDI

Supplied in sturdy plastic case.

PART NO. 35181

HI-CARBON STEEL TAPS - U.S. SIZES (PLUG & TAPER)

Type 720 -Plug -Fractional , Type 721 -Plug -Machine Screw
Type 740 -Taper Fractional , Type 741 -Taper Machine Screw

- Made of super tough carbon steel, these taps are ideal for hand tapping and re-threading applications.



Plug - Type 721



Taper-Type 741

TYPE 720 -PLUG FRACTIONAL

Part No.	Size	Tap Drill Size	No. of Flutes	Qty. per/pack
55010	3/16x24	26	4	3
55020	3/16x32	22	4	3
55030	1/4x20	7	4	3
55040	1/4x28	3	4	3
55050	5/16x18	17/64	4	3
55060	5/16x24	17/64	4	3
55070	3/8x16	5/16	4	3
55080	3/8x24	21/64	4	3
55090	7/16x14	3/8	4	3
55100	7/16x20	25/64	4	3
55110	1/2x13	27/64	4	3
55120	1/2x20	29/64	4	3
55130	9/16x12	31/64	4	1
55140	9/16x18	33/64	4	1
55150	5/8x11	17/32	4	1
55720	5/8x18	37/64	4	1
55730	11/16x11	19/32	4	1
55740	11/16x16	5/8	4	1
55160	3/4x10	21/32	4	1
55890	3/4x16	11/16	4	1
55170	7/8x9	49/64	4	1
55180	7/8x14	13/16	4	1
55190	1x8	7/8	4	1
55200	1x12	29/32	4	1
55210	1x14	15/16	4	1

TYPE 740 -TAPER FRACTIONAL

Part No.	Size	Tap Drill Size	No. of Flutes	Qty. per/pack
55250	3/16x24	26	4	3
55260	3/16x32	22	4	3
55270	1/4x20	7	4	3
55280	1/4x28	3	4	3
55290	5/16x18	17/64	4	3
55300	5/16x24	17/64	4	3
55310	3/8x16	5/16	4	3
55320	3/8x24	21/64	4	3
55330	7/16x14	3/8	4	3
55340	7/16x20	25/64	4	3
55350	1/2x13	27/64	4	3
55360	1/2x20	29/64	4	3
55370	9/16x12	31/64	4	1
55380	9/16x18	33/64	4	1
55390	5/8x11	17/32	4	1
55460	5/8x18	37/64	4	1
55470	11/16x11	19/32	4	1
55480	11/16x16	5/8	4	1
55400	3/4x10	21/32	4	1
55710	3/4x16	2/3	4	1
55410	7/8x9	11/16	4	1
55420	7/8x14	13/16	4	1
55430	1x8	7/8	4	1
55440	1x12	29/32	4	1
55450	1x14	15/16	4	1

TYPE 721 -PLUG MACHINE SCREW

Part No.	Size	Tap Drill Size	No. of Flutes	Qty. per/pack
54860	0x80	3/64	3	3
54870	1x64	53	3	3
54880	1x72	53	3	3
54890	2x56	50	3	3
54900	2x64	50	3	3
54910	3x48	47	3	3
54920	3x56	46	3	3
55750	4x36	43	3	3
55760	4x40	44	3	3
55770	5x40	38	3	3
55780	6x32	36	3	3
55790	6x40	34	3	3
55800	6x48	32	3	3
55810	8x32	29	3	3
55820	8x36	29	3	3
55830	8x40	28	3	3
55840	10x24	25	3	3
55850	10x32	21	3	3
55860	12x24	16	3	3
55870	12x28	16	3	3
55880	14x20	10	3	3

TYPE 741 -TAPER MACHINE SCREW

Part No.	Size	Tap Drill Size	No. of Flutes	Qty. per/pack
54790	0X80	3/64	3	3
54800	1X64	53	3	3
54810	1X72	53	3	3
54820	2X56	50	3	3
54830	2X64	50	3	3
54840	3X48	47	3	3
54850	3X56	46	3	3
55900	4x36	43	3	3
55910	4x40	44	3	3
55920	5x40	38	3	3
55930	6x32	36	3	3
55940	6x40	34	3	3
55950	6x48	32	3	3
55960	8x32	29	3	3
55970	8x36	29	3	3
55980	8x40	28	3	3
55990	10x24	25	3	3
56000	10x32	21	3	3
56010	12x24	16	3	3
56020	12x28	16	3	3
56030	14x20	10	3	3

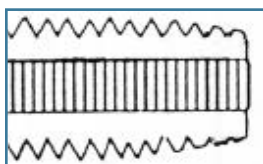

PLUG - Type 720 & 721

Three to five threads chamfered. For general use when tapping into the bottom of the hole is not critical. (This is the most widely used style.)

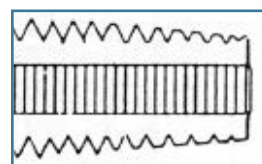

TAPER - Type 740 & 741

Eight to ten threads chamfered for easy use thread starting in tough materials.

HI-CARBON STEEL TAPS - U.S. SIZES (BOTTOMING & 3 Piece SETS)

Type 760 -Bottoming -Fractional , Type 761 -Bottoming -Machine Screw

Type 722 -3 pc. Sets -Fractional , Type 723 -3 pc. Sets -Machine Screw



Bottoming - Type 761

TYPE 760 BOTTOMING FRACTIONAL

Part No.	Size	Tap Drill Size	No. of Flutes	Qty. per/pack
55500	3/16x24	26	4	3
55510	3/16x32	22	4	3
55520	1/4x20	7	4	3
55530	1/4x28	3	4	3
55540	5/16x18	17/64	4	3
55550	5/16x24	17/64	4	3
55560	3/8x16	5/16	4	3
55570	3/8x24	21/64	4	3
55580	7/16x14	3/8	4	3
55590	7/16x20	25/64	4	3
55600	1/2x13	27/64	4	3
55610	1/2x20	29/64	4	3
55620	9/16x12	31/64	4	1
55630	9/16x18	33/64	4	1
55640	5/8x11	17/32	4	1
56040	5/8x18	37/64	4	1
56050	11/16x11	19/32	4	1
56060	11/16x16	5/8	4	1
55650	3/4x10	21/32	4	1
56070	3/4x16	2/3	4	1
55660	7/8x9	11/16	4	1
55670	7/8x14	13/16	4	1
55680	1x8	7/8	4	1
55690	1x12	29/32	4	1
55700	1x14	15/16	4	1

3 PC. SETS TYPE 722 FRACTIONAL

Part No.	Size	Tap Drill Size	No. of Flutes	Qty. per/pack
56300	3/16x24	26	4	1
56310	3/16x32	22	4	1
56320	1/4x20	7	4	1
56330	1/4x28	3	4	1
56340	5/16x18	17/64	4	1
56350	5/16x24	17/64	4	1
56360	3/8x16	5/16	4	1
56370	3/8x24	21/64	4	1
56380	7/16x14	3/8	4	1
56390	7/16x20	25/64	4	1
56400	1/2x13	27/64	4	1
56410	1/2x20	29/64	4	1
56420	9/16x12	31/64	4	1
56430	9/16x18	33/64	4	1
56440	5/8x11	17/32	4	1
56590	5/8x18	37/64	4	1
56740	11/16x11	19/32	4	1
56750	11/16x16	5/8	4	1
56450	3/4x10	21/32	4	1
56760	3/4x16	11/16	4	1
56460	7/8x9	49/64	4	1
56470	7/8x14	13/16	4	1
56480	1x8	7/8	4	1
56490	1x12	29/32	4	1
56500	1x14	15/16	4	1

TYPE 761 BOTTOMING MACHINE SCREW

Part No.	Size	Tap Drill Size	No. of Flutes	Qty. per/pack
54930	0x80	3/64	3	3
54940	1x64	53	3	3
54950	1x72	53	3	3
54960	2x56	50	3	3
54970	2x64	50	3	3
54980	3x48	47	3	3
54990	3x56	46	3	3
56100	4x36	43	3	3
56110	4x40	44	3	3
56120	5x40	38	3	3
56130	6x32	36	3	3
56140	6x40	34	3	3
56150	6x48	32	3	3
56160	8x32	29	4	3
56170	8x36	29	4	3
56180	8x40	28	4	3
56190	10x24	25	4	3
56200	10x32	21	4	3
56210	12x24	16	4	3
56220	12x28	16	4	3
56230	14x20	10	4	3

3 PC. SETS TYPE 723 MACHINE SCREW

Part No.	Size	Tap Drill Size	No. of Flutes	Qty. per/pack
56600	4x36	43	3	1
56610	4x40	44	3	1
56620	5x40	38	3	1
56630	6x32	36	3	1
56640	6x40	34	3	1
56650	6x48	32	3	1
56660	8x32	29	4	1
56670	8x36	29	4	1
56680	8x40	28	4	1
56690	10x24	25	4	1
56700	10x32	21	4	1
56710	12x24	16	4	1
56720	12x28	16	4	1
56730	14x20	10	4	1



BOTTOMING Type 760 & 761

One-and-Two threads chamfered. To use after threads have been started for tapping to the bottom of a hole.

HI-CARBON STEEL DIES - HEX DIES

Type 405 -Machine Screw & Fractional sizes , Type 790 -METRIC

- These dies are made of high quality carbon tool steel and meet the highest industry standards.
- A complete selection of solid round, adjustable round, and solid hex dies for right hand threads is available.
- Select sizes of dies may be imported.



TYPE 405 MACHINE SCREW & FRACTIONAL SIZES			
Part No.	Size	Size Across Flats	Qty. per/pack
86000	4x40	1"	3
86010	4x36	1"	3
86020	5x40	1"	3
86030	6x32	1"	3
86040	8x32	1"	3
86050	10x24	1"	3
86060	10x32	1"	3
86070	12x24	1"	3
86080	14x20	1"	3
86100	3/16x24	1"	3
86110	3/16x32	1"	3
86120	1/4x20	1"	3
86130	1/4x28	1"	3
86140	5/16x18	1"	3
86150	5/16x24	1"	3
86160	3/8x16	1"	3
86170	3/8x24	1"	3
86180	7/16x14	1"	3
86190	7/16x20	1"	3
86200	1/2x13	1"	3
86210	1/2x20	1"	3
86220	9/16x12	1-7/16"	1
86230	9/16x18	1-7/16"	1
86240	5/8x11	1-7/16"	1
86250	5/8x18	1-7/16"	1
86260	11/16x11	1-7/16"	1
86270	11/16x16	1-7/16"	1
86280	3/4x10	1-7/16"	1
86290	3/4x16	1-7/16"	1
86300	7/8x9	1-5/8"	1
86310	7/8x14	1-5/8"	1
86320	1x8	1-13/16"	1
86330	1x12	1-13/16"	1
86340	1x14	1-13/16"	1
86350	1/8x27	1"	1
86360	1/4x18	1"	1
86380	3/8x18	1-7/16"	1
86390	1/2x14	1-5/8"	1
86420	3/4x14	2"	1
86430	1-11-1/2"	2-3/8"	1

TYPE 790 METRIC SIZES			
Part No.	Size	Size Across Flats	Qty. per/pack
84000	3x.50	1"	3
84010	3x.60	1"	3
84020	4x.70	1"	3
84030	4x.75	1"	3
84040	5x.80	1"	3
84050	5x.90	1"	3
84060	6x1.00	1"	3
84070	7x1.00	1"	3
84270	8x1.00	1"	3
84080	8x1.25	1"	3
84090	9x1.00	1"	3
84100	9x1.25	1"	3
84110	10x1.00	1"	3
84120	10x1.25	1"	3
84130	10x1.50	1"	3
84140	11x1.50	1"	3
84280	12x1.25	1"	3
84150	12x1.50	1"	3
84160	12x1.75	1"	3
84170	14x1.25	1-7/16"	1
84290	14x1.50	1-7/16"	1
84180	14x2.00	1-7/16"	1
84190	16x1.50	1-7/16"	1
84200	16x2.00	1-7/16"	1
84210	18x1.50	1-7/16"	1
84300	18x2.00	1-7/16"	1
84220	18x2.50	1-7/16"	1

HEXAGONAL DIES: TIPS
Carbon steel dies are primarily used for restoring damaged threads. Hex shape allows them to be driven in cramped quarters with a wrench.

HI-CARBON STEEL DIES - ADJUSTABLE & ROUND

Type 415 -Adjustable , Type 400 -Round

- These dies are made of high quality carbon tool steel and meet the highest industry standards.
- We offer a complete selection of solid round and adjustable round for right hand threads.
- Select sizes of dies may be imported.



TYPE 415 - ADJUSTABLE MACHINE SCREW & FRACTIONAL

Part No.	Size	O.D.	Qty. per/pack
85000	0x80	1"	3
85010	1x64	1"	3
85020	1x72	1"	3
85030	2x56	1"	3
85040	2x64	1"	3
85050	3x48	1"	3
85060	3x56	1"	3
85070	4x40	1"	3
85080	4x36	1"	3
85090	5x40	1"	3
85100	6x32	1"	3
85110	8x32	1"	3
85120	10x24	1"	3
85130	10x32	1"	3
85140	12x24	1"	3
85150	14x20	1"	3
85170	3/16x24	1"	3
85180	3/16x32	1"	3
85190	1/4x20	1"	3
85200	1/4x28	1"	3
85210	5/16x18	1"	3
85220	5/16x24	1"	3
85230	3/8x16	1"	3
85240	3/8x24	1"	3
85250	7/16x14	1"	3
85260	7/16x20	1"	3
85270	1/2x13	1"	3
85280	1/2x20	1"	3
85290	9/16x12	1-1/2"	1
85300	9/16x18	1-1/2"	1
85310	5/8x11	1-1/2"	1
85320	5/8x18	1-1/2"	1
85330	11/16x11	2"	1
85340	11/16x16	1-1/2"	1
85350	3/4x10	2"	1
85360	3/4x16	2"	1
85370	7/8x9	2"	1
85380	7/8x14	2"	1
85390	1x8	2"	1
85400	1x12	2"	1
85410	1x14	2"	1
85420	1/8x27	1"	3
85430	1/4x18	1-1/2"	1
85440	3/8x18	1-1/2"	1
85450	1/2x14	1-1/2"	1

TYPE 400 - ROUND MACHINE SCREW & FRACTIONAL

Part No.	Size	O.D.	Qty. per/pack
53600	4x36	1"	3
53610	4x40	1"	3
53620	5x40	1"	3
53630	6x32	1"	3
53640	8x32	1"	3
53650	10x24	1"	3
53660	10x32	1"	3
53670	12x24	1"	3
53680	14x20	1"	3
53690	3/16x24	1"	3
53700	3/16x32	1"	3
53710	1/4x20	1"	3
53720	1/4x28	1"	3
53730	5/16x18	1"	3
53820	5/16x24	1"	3
53740	3/8x16	1"	3
53750	3/8x24	1"	3
53760	7/16x14	1"	3
53830	7/16x20	1"	3
53770	1/2x13	1"	3
53780	1/2x20	1"	3
53790	1/2x24	1"	3
53800	1/8x27 (PIPE)	1"	3
53810	1/4x18 (PIPE)	1"	3

ADJUSTABLE & ROUND DIES: TIPS

Adjustable Dies:

These dies have a recessed adjusting screw so threads can be cut slightly under-size or over-size.

Round Dies:

Inexpensive round dies are 1" wide. They will thread rods up to 1/2" diameter.

HI-CARBON TAPS - METRIC PLUG & TAPERED PIPE TAPS

Type 780 -Metric Plug

- All popular sizes offered for foreign car, motorcycle, and machinery threading needs.



Type 410 Pipe Taps

- Made of tough carbon steel to industry standards.



TYPE 780 - METRIC PLUG

Part No.	Size	Tap Drill Size	Number of Flutes	Qty. per/pack
83010	3x.50	40	3	3
83020	3x.60	3/32"	3	3
83030	4x.70	1/8	4	3
83040	4x.75	1/8	4	3
83050	5x.80	11/64"	4	3
83060	5x.90	20	4	3
83070	6x1.00	13/64"	4	3
83080	7x1.00	15/64"	4	3
84230	8x1.00	F	4	3
83090	8x1.25	17/64"	4	3
83100	9x1.00	5/16"	4	3
83110	9x1.25	5/16"	4	3
56800	10x1.00	23/64"	4	3
83130	10x1.25	S	4	3
83140	10x1.50	11/32"	4	3
83150	11x1.50	3/8"	4	3
84240	12x1.25	27/64"	4	3
83160	12x1.50	13/32"	4	3
83170	12x1.75	27/64"	4	3
56810	14x1.25	33/64"	4	1
84250	14x1.50	1/2"	4	1
83190	14x2.00	15/32"	4	1
83200	16x1.50	37/64"	4	1
83210	16x2.00	35/64"	4	1
56820	18x1.50	21/32"	4	1
84260	18x2.00	5/8"	4	1
83230	18x2.50	39/64"	4	1

TYPE 410 PIPE TAPS FRACTIONAL

Part No.	Diameter	Tap Drill Size	Number of Flutes	Qty. per/pack
56910	1/8 x 27	11/32"	4	3
56920	1/4 x 18	7/16"	4	3
56930	3/8 x 18	37/64"	4	1
56940	1/2 x 14	23/32"	4	1
56950	3/4 x 14	59/64"	4	1
56960	1 x 11-1/2	1-5/32"	5	1
56970	1-1/4 x 11-1/2	1-1/2"	5	1
56980	1-1/2 x 11-1/2	1-47/64"	7	1
56990	2 x 11-1/2	2-7/32"	7	1



Product Tips

NEED A TAPPING LUBE?
High Performance Ultra SP™

Clings to vertical surfaces
for continual lubrication.

Found on page 98

14PC / 16PC HI-CARBON TAP & DIE SETS

Type 724

Professional Quality

- Made of high carbon tool steel.
- Sharp, clean cutting edges, hardened, and tempered to cut smooth threads.
- Sets are available in round and hexagon styles.
- Sets are packed in plastic cases.



14pc. Hi-Carbon Steel Fractional NC - with Hex Die Set

Set contains:

- Hi-Carbon steel plug taps and hex dies sizes:
1/4-20, 5/16-18, 3/8-16, 7/16-14, 1/2-13, 1/8-27 NPT Pipe
- T-Handle Tap Wrench: 3/16 to 1/2
- Stock #HNC14PC

Supplied in sturdy plastic case.

PART NO. 50090

16pc. Hi-Carbon Steel METRIC - with Hex Die Set

Set contains:

- Hi-Carbon steel plug taps and hex dies sizes:
4mm x 0.70, 5mm x 0.80, 6mm x 1.00, 8mm x 1.25,
10mm x 1.25, 10mm x 1.50, 12mm x 1.50
- T-Handle Tap Wrench: 3/16 to 1/2
- Stock #HMM16PC

PART NO. 50140

14pc. Hi-Carbon Steel Fractional NF - with Hex Die Set

Set contains:

- Hi-Carbon steel plug taps and hex dies sizes:
1/4-28, 5/16-24, 3/8-24, 7/16-20, 1/2-20, 1/8-27 NPT Pipe
- T-Handle Tap Wrench: 3/16 to 1/2
- Stock #HNF14PC

Supplied in sturdy plastic case.

PART NO. 50080

16pc. Hi-Carbon Steel Fractional NC - with Hex Die Set

Set contains:

- Hi-Carbon steel plug taps and hex dies sizes:
4-40, 6-32, 8-32, 10-24, 10-32, 12-24, 1/4-20
- T-Handle Tap Wrench: 0 to 1/4
- Stock #HEX16PC

PART NO. 50100

14pc. Hi-Carbon Steel Fractional NC - with Round Die Set

Set contains:

- Hi-Carbon steel plug taps and round dies sizes:
1/4-20, 5/16-18, 3/8-16, 7/16-14, 1/2-13, 1/8-27 NPT Pipe
- T-Handle Tap Wrench: 3/16 to 1/2
- Stock #RNC14PC

Supplied in sturdy plastic case.

PART NO. 50030

16pc. Hi-Carbon Steel Fractional NC - with Round Die Set

Set contains:

- Hi-Carbon steel plug taps and round dies sizes:
4-40, 6-32, 8-32, 10-24, 10-32, 12-24, 1/4-20
- T-Handle Tap Wrench: 0 to 1/4
- Stock #RND19PC

PART NO. 50040

14pc. Hi-Carbon Steel Fractional NF - with Round Die Set

Set contains:

- Hi-Carbon steel plug taps and round dies sizes:
1/4-28, 5/16-24, 3/8-24, 7/16-20, 1/2-20, 1/8-27 NPT Pipe
- T-Handle Tap Wrench: 3/16 to 1/2

Supplied in sturdy plastic case.

PART NO. 50020

METRIC

Hi Carbon Tap & Die Sets

24PC / 37PC HI-CARBON TAP & DIE SETS

Type 724

Professional Quality

- Made of high carbon tool steel.
- Plug taps are furnished in all sets.
- Dies are available in round and hexagon styles.
- Sets are packed in plastic.



24pc. Hi-Carbon Steel Fractional Tap NC, NF - with Hex Die Set

Set contains:

- Hi-Carbon steel plug taps and hex dies sizes: 1/4-20, 1/4-28, 5/16-18, 5/16-24, 3/8-16, 3/8-24, 7/16-14, 7/16-20, 1/2-13, 1/2-20, 1/8-27 NPT Pipe
- T-Handle Tap Wrench: 3/16 to 1/2
- Economy die stock
- Stock #HEX24PC

Supplied in sturdy plastic case.

PART NO. 50110

24pc. Hi-Carbon Steel Fractional Tap NC, NF - with Round Die Set

Set contains:

- Hi-Carbon steel plug taps and round dies sizes: 1/4-20, 1/4-28, 5/16-18, 5/16-24, 3/8-16, 3/8-24, 7/16-14, 7/16-20, 1/2-13, 1/2-20, 1/8-27 NPT Pipe
- T-Handle Tap Wrench: 3/16 to 1/2
- Economy die stock
- Stock #RND24PC

Supplied in sturdy plastic case.

PART NO. 50050

37pc. Hi-Carbon Steel Machine Screw & Fractional Tap NC, NF - with Round Die Set

Set contains:

- Hi-Carbon steel plug taps and round dies sizes: 4-40, 6-32, 8-32, 10-24, 10-32, 12-24, 1/4-20, 1/4-28, 5/16-18, 5/16-24, 3/8-16, 3/8-24, 7/16-14, 7/16-20, 1/2-13, 1/2-20, 1/8-27 NPT Pipe
- T-Handle Tap Wrench: 0 to 1/4 & 3/16 to 1/2
- Economy die stock
- Stock #RND37PC

Supplied in sturdy plastic case.

PART NO. 50060

37pc. Hi-Carbon Steel Master METRIC - with Hex Die Set

Set contains:

- Hi-Carbon steel plug taps and hex dies sizes: 3mm x 0.50, 3mm x 0.60, 4mm x 0.70, 4mm x 0.75, 5mm x 0.80, 5mm x 0.90, 6mm x 1.00, 7mm x 1.00, 8mm x 1.25, 9mm x 1.00, 9mm x 1.25, 10mm x 1.25, 10mm x 1.50, 11mm x 1.50, 12mm x 1.50, 12mm x 1.75, 1/8-27 NPT Pipe
- T-Handle Tap Wrench: 0 to 1/4 & 3/16 to 1/2
- Stock #HMM37PC

Supplied in sturdy plastic case.

PART NO. 50150

37pc. Hi-Carbon Steel Machine Screw & Fractional NC, NF - with Hex Die Set

Set contains:

- Hi-Carbon steel plug taps and round hex dies sizes: 4-40, 6-32, 8-32, 10-24, 10-32, 12-24, 1/4-20, 1/4-28, 5/16-18, 5/16-24, 3/8-16, 3/8-24, 7/16-14, 7/16-20, 1/2-13, 1/2-20, 1/8-27 NPT Pipe
- T-Handle Tap Wrench: 0 to 1/4 & 3/16 to 1/2
- Stock #HEX37PC

Supplied in sturdy plastic case.

PART NO. 50120

METRIC

Hi-Carbon Tap & Die Sets

40PC HI-CARBON MACHINE SCREW / FRACTIONAL

Type 724

Professional Quality

- Taps and Dies made of high carbon steel.
- Plug taps are furnished in all sets in sizes to fill most requirements.
- Dies are available in round and hex styles.
- Sets are packed in durable plastic cases.



40pc. Hi-Carbon Steel Machine Screw Fractional Tap NC, NF - with Round Die Set

Set contains:

- Hi-Carbon steel plug taps and round dies sizes: 4-40, 6-32, 8-32, 10-24, 10-32, 12-24, 1/4-20, 1/4-28, 5/16-18, 5/16-24, 3/8-16, 3/8-24, 7/16-14, 7/16-20, 1/2-13, 1/2-20, 1/8-27 NPT Pipe
 - T-Handle Tap Wrench: 0 to 1/4 & 3/16 to 1/2
 - Tap & Reamer Wrench: #4 to 1/2
 - Adjustable Die Stock, Screw Driver, Screw Pitch Gauge
 - Stock #RND40PC
- Supplied in sturdy plastic case.*

PART NO. 50070

40pc. Hi-Carbon Steel Machine Screw / Fractional NC, NF - with Hex Die Set

Set contains:

- Hi-Carbon steel plug taps and hex dies sizes: 4-40, 6-32, 8-32, 10-24, 10-32, 12-24, 1/4-20, 1/4-28, 5/16-18, 5/16-24, 3/8-16, 3/8-24, 7/16-14, 7/16-20, 1/2-13, 1/2-20, 1/8-27 NPT Pipe
 - T-Handle Tap Wrench: 0 to 1/4 & 1/4 to 1/2
 - Tap & Reamer Wrench: 0 to 1/2
 - Adjustable Die Stock, Screw Driver, Screw Pitch Gauge
 - Stock #HEX40PC
- Supplied in sturdy plastic case.*

PART NO. 50130

TAP & REAMER WRENCHES

- Accessories for every threading job, economy, and professional type.
- Rugged construction.
- Tap wrench jaws heat treated and hardened for long life.
- Offered in display packages as indicated.

Type 725

Tap & Reamer Wrenches - Professional Quality

- Hardened steel jaws. Adjusts easily by turning handles



Part No.	For Tap Sizes	Package Type	Qty. per/pack
50350	1/4-3/4 (3/8 NPT)	Bulk	1
50360	1/2-1-1/8 (3/4 NPT)	Bulk	1
50347	4-1/2	Carded	1

Type 726

Tap & Reamer Wrench - Economy

- For taps up to 1/2"
- Chrome finished, knurled handles with black center



Part No.	For Tap Sizes	Package Type	Qty. per/pack
50337	Up to 1/2	Carded	1

Type 727R

Ratcheting T-Handle Tap Wrenches



- Three position gear box for quick efficient ratcheting action
- Designed for use with taps, reamers, screw extractors and other tools with a square shank.
- Chrome plated for long life and rust resistance

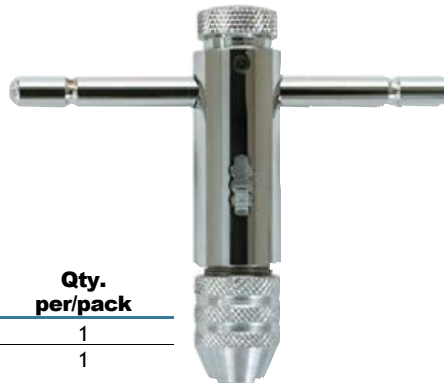

Part No.	For Tap Sizes	Package Type	Qty. per/pack
50190	0 - 1/4" (3mm - 6mm)	Bulk	1
50200	1/4 - 1/2" (6mm - 12mm)	Bulk	1

Type 727

T-Handle Tap Wrenches

- Sliding T-handle with spring tension to hold taps in place, self equalizing jaws.
- No. 50320 has removable handle and 3/8" female square drive for extensions, ratchet, and power drive.

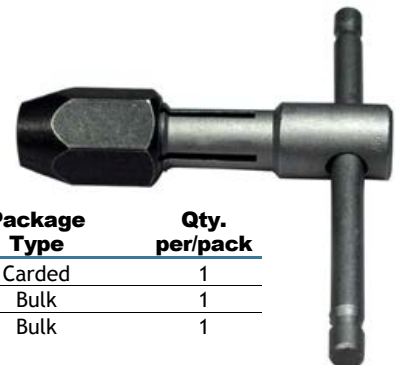

Part No.	For Tap Sizes	Package Type	Qty. per/pack
50307	0-1/4	Carded	1
50310	3/16-1/2	Bulk	1
50320	3/16-1/2	Bulk	1

DIE STOCKS AND SCREW PITCH GAUGES

- Accessories for every threading job, economy and professional type.
- Rugged construction. Offered in display packages as indicated.



Type 728
Die Stock
- Economy Solid

- Designed to hold either 1"- Round or Hex dies.

TYPE 728 DIE STOCK

Part No.	Across Flats	Package Type	Qty. per/pack
50377	1" round or hex	Carded	1



Type 729
Die Stock
- Professional Quality

- Numbers 50387 and 50390 have 3-jaw self centering adjustable guides to assure straight threads and easy starting.
- Number 50400 is a sturdy cast hex die stock with chromed steel handles.

TYPE 729 DIE STOCK

Part No.	Across Flats	Package Type	Qty. per/pack
50390	1-1/2" Round. , 1-7/16" Hex	Bulk	1
50400	1-7/8" Hex	Bulk	1
50387	1" Round or Hex	Carded	1



Type 730
- Screw Pitch Gauges

- Made with flat thread forms on top of each blade.
- Gives screw pitches on V-threads, U.S. and Metric gauges available.

TYPE 730 SCREW PITCH GAUGES

Part No.	For Tap Sizes	Package Type	Qty. per/pack
50417	US 12 - 40 U.S.	Carded	1
50427	METRIC 0.5 - 1.75 mm, #27 and #28	Carded	1

STANDARD CUTTING TAPS

Machine Screw Sizes

Tap	Tap Drill	Decimal Equiv. of Tap Drill	Theoretical % of Thread	Prob-able Oversize (Mean)	Prob-able Hole Size	Percentage of Thread
0-80	56	.0465	83	.0015	.0480	74
	5/64	.0469	81	.0015	.0484	71
1-64	54	.0550	89	.0015	.0565	81
1-72	53	.0595	75	.0015	.0610	67
2-56	51	.0670	82	.0017	.0687	74
	50	.0700	69	.0017	.0717	62
2-64	50	.0700	79	.0017	.0717	70
3-48	48	.0760	86	.0019	.0779	78
	7/64	.0781	77	.0019	.0800	70
	47	.0785	76	.0019	.0804	69
	46	.0810	67	.0019	.0829	60
3-56	46	.0810	78	.0019	.0829	69
	45	.0820	73	.0019	.0839	65
4-40	44	.0860	80	.0020	.0880	74
	43	.0890	71	.0020	.0910	65
4-48	42	.0935	68	.0020	.0955	61
	3/32	.0938	68	.0020	.0958	60
5-40	40	.0980	83	.0023	.1003	76
	39	.0995	79	.0023	.1018	71
	38	.1015	72	.0023	.1038	65
5-44	38	.1015	79	.0023	.1038	72
	37	.1040	71	.0023	.1063	63
6-32	37	.1040	84	.0023	.1063	78
	36	.1065	78	.0026	.1091	71
	3/16	.1094	70	.0026	.1120	64
	35	.1100	69	.0026	.1126	63
6-40	34	.1110	67	.0026	.1136	60
	33	.1130	77	.0026	.1156	69
8-32	29	.1360	69	.0029	.1389	62
	32	.1160	68	.0026	.1186	60
8-36	29	.1360	78	.0029	.1389	70
	27	.1440	85	.0032	.1472	79
10-24	26	.1470	79	.0032	.1502	74
	25	.1495	75	.0032	.1527	69
	24	.1520	70	.0032	.1552	64
	23	.1540	67	.0032	.1572	61
	10-32	22	.1570	81	.0032	.1602
21		.1590	76	.0032	.1622	68
20		.1610	71	.0032	.1642	64
12-24		17	.1730	79	.0035	.1765
	16	.1770	72	.0035	.1805	66
	15	.1800	67	.0035	.1835	60
	12-28	16	.1770	84	.0035	.1805
15		.1800	78	.0035	.1835	70
14		.1820	73	.0035	.1855	66

These tables show both the theoretical percentage of thread represented by the drill size and the percentage that would normally be obtained in drilling.

Fractional Sizes

Tap	Tap Drill	Decimal Equiv. of Tap Drill	Theoretical % of Thread	Prob-able Oversize (Mean)	Prob-able Hole Size	Percentage of Thread
1/4-20	9	.1960	83	.0038	.1998	77
	8	.1990	79	.0038	.2028	73
	7	.2010	75	.0038	.2048	70
	3/16	.2031	72	.0038	.2069	66
	6	.2040	71	.0038	.2078	65
1/4-28	5	.2055	69	.0038	.2093	63
	4	.2090	63	.0038	.2128	57
5/16-18	F	.2570	77	.0038	.2608	72
	G	.2610	71	.0041	.2651	68
5/16-24	H	.2660	86	.0041	.2701	78
	I	.2720	75	.0041	.2761	67
3/8-16	1/8	.3125	77	.0044	.3169	72
	O	.3160	73	.0044	.3204	68
3/8-24	7/64	.3281	87	.0044	.3325	79
	Q	.3320	79	.0044	.3364	71
3/8-14	T	.3580	86	.0046	.3626	81
	23/64	.3594	84	.0046	.3640	79
	U	.3680	75	.0046	.3726	70
	1/2	.3750	67	.0046	.3796	62
	V	.3770	65	.0046	.3816	60
1/2-20	W	.3860	79	.0046	.3906	72
	25/64	.3906	72	.0046	.3952	65
1/2-13	27/64	.4219	78	.0047	.4266	73
	1/2-20	.4531	72	.0047	.4578	65
1/2-12	13/32	.4688	87	.0048	.4736	82
	31/64	.4844	72	.0048	.4892	68
1/2-18	1/2	.5000	87	.0048	.5048	80
5/8-11	13/32	.5313	79	.0049	.5362	75
	29/64	.5469	66	.0049	.5518	62
5/8-18	1/8	.5625	87	.0049	.5674	80
3/4-10	11/32	.6406	84	.0050	.6456	80
	21/32	.6563	72	.0050	.6613	68
3/4-16	1/16	.6875	77	.0050	.6925	71
3/4-9	11/32	.7656	76	.0052	.7708	72
	25/32	.7812	65	.0052	.7864	61
3/4-14	11/32	.7969	84	.0052	.8021	79
	1/4	.8125	67	.0052	.8177	62
1"-8	9/32	.8594	87	.0059	.8653	83
	1/2	.8750	77	.0059	.8809	73
	11/16	.8906	67	.0059	.8965	64
1"-12	23/32	.9063	87	.0060	.9122	81
	11/16	.9219	72	.0060	.9279	67
1"-14	11/16	.9219	84	.0060	.9279	78
	1/8	.9375	67	.0060	.9435	61
1 1/4-7	23/32	.9688	84	.0062	.9750	81
	11/16	.9844	76	.0067	.9911	72
	1"	1.0000	67	.0070	1.0070	64
1 1/4-12	1 1/32	1.0313	87	.0071	1.0384	80
	1 1/64	1.0469	72	.0072	1.0541	66
1 1/4-7	1 1/32	1.0938	84			
	1 1/64	1.1094	76			
	1 1/8	1.1250	67			
1 1/4-12	1 1/32	1.1563	87			
	1 1/64	1.1719	72			
1 1/2-6	1 1/16	1.1875	87			
	1 1/32	1.2031	79			
	1 1/64	1.2188	72			
1 1/2-12	1 1/32	1.2344	65			
	1 1/16	1.2813	87			
	1 1/64	1.2969	72			
1 1/2-6	1 1/8	1.3125	87			
	1 1/16	1.3281	79			
	1 1/32	1.3438	72			
	1 1/64	1.3594	65			
1 1/2-12	1 1/32	1.4063	87			
	1 1/64	1.4219	72			

Metric Cutting Taps

Metric Tap Size	Basic Major Dia. (Ins.)	Tap Drill Size	Decimal Equiv. of Tap Drill (Ins.)	Theoretical Percent of Thread	Probable Mean Over-Size (Ins.)	Probable Hole Size (Ins.)	Probable Percent of Thread
M1.6 x 0.35	.0630	1.25 mm	.0492	77	.0015	.0507	69
M1.8 x 0.35	.0709	1.45 mm	.0571	77	.0015	.0586	69
M2 x 0.4	.0787	1/16"	.0625	79	.0015	.0640	72
		1.60 mm	.0630	77	.0017	.0647	69
		#52	.0635	74	.0017	.0652	66
M2.2 x 0.45	.0866	1.75 mm	.0689	77	.0017	.0706	70
M2.5 x 0.45	.0984	2.05 mm	.0807	77	.0019	.0826	69
		#48	.0810	76	.0019	.0829	67
		#45	.0820	71	.0019	.0839	63
M3 x 0.5	.1181	#40	.0980	79	.0023	.1003	70
		2.5 mm	.0984	77	.0023	.1007	68
		#39	.0995	73	.0023	.1018	64
M3.5 x 0.6	.1378	#33	.1130	81	.0028	.1158	72
		2.9 mm	.1142	77	.0026	.1168	68
		#32	.1160	71	.0026	.1186	63
M4 x 0.7	.1575	*3.25 mm	.1280	82	.0029	.1309	74
		#30	.1285	81	.0029	.1314	73
		3.3 mm	.1299	77	.0029	.1328	69
M4.5 x 0.75	.1772	3.7 mm	.1457	82	.0032	.1489	74
		#26	.1470	79	.0032	.1502	70
		*3.75 mm	.1478	77	.0032	.1508	69
		#25	.1495	72	.0032	.1527	64
M5 x 0.8	.1968	4.2 mm	.1654	77	.0032	.1686	69
		#19	.1660	75	.0032	.1692	68
M6 x 1	.2362	#10	.1935	84	.0038	.1973	76
		#9	.1960	79	.0038	.1998	71
		5 mm	.1968	77	.0038	.2006	70
		#8	.1990	73	.0038	.2028	65
M7 x 1	.2756	"A"	.2340	81	.0038	.2378	74
		1 1/16"	.2344	81	.0038	.2382	73
		6 mm	.2362	77	.0038	.2400	70
		"B"	.2380	74	.0038	.2418	68
M8 x 1.25	.3150	6.7 mm	.2638	80	.0041	.2679	74
		1 1/8"	.2656	77	.0041	.2697	71
		*6.75 mm	.2657	77	.0041	.2698	71
		"H"	.2660	77	.0041	.2701	70
M8 x 1	.3150	6.8 mm	.2677	74	.0041	.2718	68
		"J"	.2770	74	.0041	.2811	68
M10 x 1.5	.3937	8.4 mm	.3307	82	.0044	.3351	76
		"Q"	.3320	80	.0044	.3364	75
M10 x 1.25	.3937	8.5 mm	.3346	77	.0044	.3390	71
		8.7 mm	.3425	80	.0046	.3471	73
		1 1/2"	.3438	78	.0046	.3483	71
M12 x 1.75	.4724	*8.75 mm	.3445	77	.0046	.3491	70
		"Y"	.4040	76	.0047	.4087	71
		1 3/8"	.4062	74	.0047	.4109	69

Note: Sizes with an asterisk (*) are not standard drills.

Metric Tap Size	Basic Major Dia. (Ins.)	Tap Drill Size	Decimal Equiv. of Tap Drill (Ins.)	Theoretical Percent of Thread	Probable Mean Over-Size (Ins.)	Probable Hole Size (Ins.)	Probable Percent of Thread	
M12 x 1.25	.4724	1 1/4"	.4219	79	.0047	.4266	72	
		10.8 mm	.4252	74	.0047	.4299	66	
M14 x 2	.5512	1 1/2"	.4688	81	.0048	.4736	76	
		12 mm	.4724	77	.0048	.4772	72	
M14 x 1.5	.5512	12.5 mm	.4921	77	.0048	.4969	71	
M16 x 2	.6299	1 3/4"	.5469	81	.0049	.5518	76	
		14 mm	.5512	77	.0049	.5561	72	
M16 x 1.5	.6299	14.5 mm	.5709	77	.0049	.5758	71	
M18 x 2.5	.7087	1 3/4"	.6094	78	.0050	.6144	74	
		15.5 mm	.6102	77	.0050	.6152	73	
M18 x 1.5	.7087	1 5/8"	.6406	89	.0050	.6456	82	
		16.5 mm	.6496	77	.0050	.6546	70	
M20 x 2.5	.7874	1 7/8"	.6562	68	.0050	.6612	62	
		17.5 mm	.6875	78	.0050	.6925	74	
M20 x 1.5	.7874	18.5 mm	.6890	77	.0052	.6942	73	
		18.5 mm	.7283	77	.0052	.7335	70	
M22 x 2.5	.8661	1 3/4"	.7856	79	.0052	.7708	75	
		19.5 mm	.7877	77	.0052	.7729	73	
M22 x 1.5	.8661	20.5 mm	.8071	77	.0052	.8123	70	
		21 mm	.8268	77	.0059	.8327	73	
M24 x 3	.9449	1 3/4"	.8281	76	.0059	.8340	72	
		22 mm	.8661	77	.0059	.8720	71	
M27 x 3	1.0630	1 3/4"	.9375	82	.0060	.9435	78	
		24 mm	.9449	77	.0062	.9511	73	
M27 x 2	1.0630	25 mm	.9843	77	.0070	.9913	70	
		1 1/2"	.9844	77	.0070	.9914	70	
M30 x 3.5	1.1811	26.5 mm	1.0433	77				
		1 1/2"	1.0469	75				
M30 x 2	1.1811	28 mm	1.1024	77				
		1 1/4"	1.1094	70				
M33 x 3.5	1.2992	1 3/4"	1.1562	80				
		29.5 mm	1.1614	77				
		1 1/4"	1.1719	71				
M33 x 2	1.2992	1 3/4"	1.2188	79				
		31 mm	1.2205	77				
M36 x 4	1.4173	1 1/2"	1.2500	82				
		32 mm	1.2598	77				
M36 x 3	1.4173	1 1/4"	1.2969	78				
		33 mm	1.2992	77				
M39 x 4	1.5354	1 3/4"	1.3750	78				
		35 mm	1.3780	77				
M39 x 3	1.5354	36 mm	1.4173	77				
		1 3/8"	1.4219	74				

REAMING RECOMMENDED

METRIC THREAD FORMULAE

$$\text{Basic major dia. (mm)} - \frac{\% \text{ thread} \times \text{mm pitch}}{76.980} = \text{Drilled hole size (mm)}$$

Taps

Tap Trouble Shooting

Problems encountered in tapping are often the fault of the tapping machine, tap holding devices and conditions of the hole to be tapped. The tapping machine should be checked for spindle, fixture and work alignment; for slipping belts, wear and power. The tap holding device should be checked as to correct type, for wear and alignment with the hole. The drilled hole should be checked for diameter and trueness in round and axis to assure correct percentage of thread engagement. Blind holes must have sufficient chip room at the bottom.

General Suggestions

1. If holes are undersize or oversize check against the setup instructions. Check the tap for correct pitch diameter limit for desired class of thread, and the drill for correct size.
2. If the tap is producing rough thread it generally means that the tap is pushing or tearing the metal instead of cutting it. The tap may be dull, have galled threads or may be running at too slow a speed. If none of these, increase the hook angle of the cutting face.
3. If the tap is loading (metal clinging to the tap) or galling, check the lubrication. Here, too, the tap may be dull, or it may be producing too high a percentage of thread. Shift to a surface-treated tap.
4. If tap breakage is encountered the tap may be cutting too high a percentage of thread, be insufficiently lubricated or have too little clearance for chips at the bottom of the blind hole. If none of these conditions exist, increase the speed, except in hard or tough materials. In these materials,

Trouble	Cause
Tap Breakage	<ol style="list-style-type: none"> 1. Wrong type of tap. 2. Dull tap. 3. Tap incorrectly ground. 4. Tap drill too small. 5. Drilled hole too shallow. 6. Misalignment of tap and hole. 7. Wrong machine. 8. Incorrect fixture or holding device. 9. Work hardened material! 10. Lack of lubricant, or use of wrong type.
Tap Failure on Reversal	<ol style="list-style-type: none"> 1. Tap cutting too tightly. Cutting face angle should be increased. 2. Tap galling. Face angle on back of land should be increased. 3. Chips wedged between flutes. (See the following)
Chips Clogging Flutes	<ol style="list-style-type: none"> 1. Wrong type of tap. 2. Insufficient chamfer. 3. Incorrect cutting face angle. 4. Flough Flutes. 5. Flutes improperly reground. 6. Lack of lubrication, or use of wrong type.
Stripped or Chipped Tap Threads	<ol style="list-style-type: none"> 1. Misalignment. 2. Careless handling. 3. Dull Tap 4. Tap too hard. 5. Wrong application of surface treated taps. 6. Improper sharpening of tap.
Torn Threads in Tapped Part	<ol style="list-style-type: none"> 1. Incorrect cutting face angle (usually too small). 2. Tap drill too small. 3. Chips clogging flutes. 4. Broken threads on taps. 5. Improper resharpening of tap. 6. Lack of lubricant, or use of wrong type.
Tap Sticking or Binding	<ol style="list-style-type: none"> 1. Tap drill too small. 2. Tap lands too wide. 3. Incorrect cutting face angle. 4. Lack of lubricant, or use of wrong type. 5. Surface treatment (lubricant) required.
Excessive Tap Wear	<ol style="list-style-type: none"> 1. Material is abrasive, or inclusions present. Surface treated tap required. 2. Misalignment.
Cutting Face Breakdown	<ol style="list-style-type: none"> 1. Incorrect cutting face angle. 2. Surface treatment required.
Overheating of Tap	<ol style="list-style-type: none"> 1. Excessive land width. 2. Lack of lubricant, or use of wrong type. 3. Dull tap. 4. Excessive flank contact, pitch diameter relief required. 5. Excessive tapping speeds.
Poor Finish on Thread in Tapped Part	<ol style="list-style-type: none"> 1. Pitch diameter relief required. 2. Incorrect cutting face angle, usually too small. 3. Tap drill too small. 4. Insufficient number of chamfered threads. 5. Dull tap. 6. Lack of lubricant, or use of wrong type.
Excessive Frictional Drag and Power Requirement	<ol style="list-style-type: none"> 1. Pitch diameter relief required. 2. Point size on tap too small. 3. Dull tap. 4. Incorrect cutting face angle. 5. Incorrect tapping speed. 6. Lack of lubricant, or use of wrong type.

Tap Limits, Product Limits

CLASS OF THREAD

We sometimes receive requests for a Class 3B (or other class) tap. Many times the customer will ask for a tap to produce a "Class 3B Fit". Ordering taps by these specifications is incorrect and often impractical. The following information is presented to clarify the difference between the terms Class of Thread, Tap Limits and Product Limits to make ordering taps easier and aid the customer in obtaining the tap best suited for their requirements.

Class of Thread

Class of Thread refers simply to the tolerances that control the closeness of fit between two threaded mating parts. This term should be used only in reference to a threaded assembly, as, for example, a screw and nut.

Product Limits

Product Limits refer to the limits and tolerances of the internal or female thread. The degree of tolerance is expressed by the terms Class 2, 2B, 3 and 3B. Product limits refer to the various limits and tolerances applying to nuts or internal threads and are identified by the terms Class 2, 2B, 3 or 3B.

Tap Limits

Tap Limits refer to the various sizes of taps manufactured to permit selection of a tap which will produce an internal thread within the desired product limit. Tap limits are designated as L-1, H-1, H-2, H-3, etc.

In the chart on this page we have illustrated the difference between tap and product limit, using a 1/4-20 tapped hole as the example.

Although ground thread taps are produced to precision tolerances under closely controlled manufacturing processes and are guaranteed for accuracy of individual elements, there is always the possibility of the presence of unknown factors which can be detrimental to good tap performance. The tap manufacturer, therefore, is not able to guarantee the size of the tapped hole.

To summarize, the following points

1. A tap cannot produce a Class of Thread. It can produce a tapped hole within specific product limits.
2. Since it is used only in tapping a hole, or producing an internal thread, a tap has no control over the fitting properties of the mating external thread.
3. To product what is commonly referred to as a "Class of Thread," both the external and internal threads must be within their respective product limits. Only when both members of a threaded assembly fall within the desired class limits can the proper fit be assured.
4. The acceptability of any class of threaded hole is determined only by an accurate "Go" or "Hi" thread plug gage of the correspond-

ing class. Similarly, the acceptability of a male part with an external thread is also determined by a corresponding "Go" or "Lo" thread ring gage.

5. When ordering taps, specify either the tap limit or the class of thread that identifies the limit of the tapped hole.
6. In special applications, supply as much information as possible. The more information our engineers have to work with, the better they can recommend a tap to do the job properly with least expense.
7. Remember, it is not always the most expensive tap which will do the job best. Our files contain many examples of special jobs which were solved with inexpensive standard taps.

1/4 - 20 Tapped Hole

Class 2 Limit GH-3 Tap

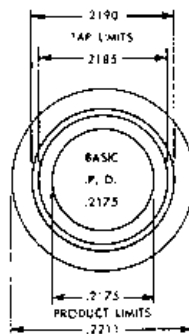

Class 2B Limit GH-5 Tap

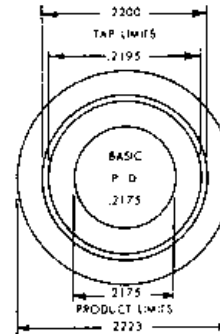

Class 3 Limit GH-2 Tap

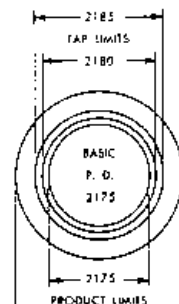

Class 3B Limit GH-3 Tap

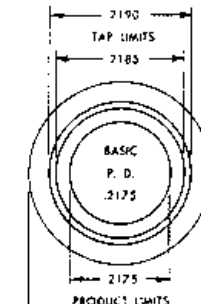

Thread Constants for Various Percentages

TAPS

EXAMPLE: To find the hole size for obtaining 75% of thread in a ¼-20 tapped hole, follow first column to 20 threads, then across to 75% of thread. This figure (.0485) when subtracted from the .250 diameter leaves .2015, which is the required diameter of the hole for a ¼-20 thread.

Relation of Tap Pitch Diameter to Basic Pitch Diameter

Relation of Tap Pitch Diameter To Basic Pitch Diameter

American tap manufacturers use a series of tap pitch diameter limits. These limits feature a .0005" tolerance in tap sizes #0 through 1", and a .001" or greater tolerance in tap sizes above 1" through 1½" diameter, inclusive. The chart shows the relationship between tap pitch diameter limits and basic (nominal) pitch diameter.

FORMULA FOR OBTAINING TAP DRILL SIZES

$$\left(\begin{array}{c} \text{Outside Diam.} \\ \text{of Thread} \end{array} \right) - \left(\frac{.01299 \times \text{Amount of percentage of full thread}}{\text{Number of threads per inch}} \right) = \text{Drilled Hole Size}$$

$$\left(\begin{array}{c} \text{No. of Threads} \\ \text{per inch} \end{array} \right) \times \left(\frac{\text{Outside Diam. of thread} - \text{Selected Drill Diam.}}{.01299} \right) = \text{Percentage of Full Thread}$$

Figures in table show amount to subtract from O.D. of screw to obtain specific percentages of thread.

Threads per Inch	Double Depth	60% Thread	65% Thread	70% Thread	75% Thread	80% Thread	85% Thread
6	.21651	.1300	.1408	.1517	.1625	.1733	.1842
7	.18558	.1114	.1207	.1300	.1393	.1486	.1579
8	.16238	.0975	.1056	.1138	.1219	.1300	.1381
9	.14434	.0866	.0939	.1011	.1083	.1156	.1228
10	.12990	.0779	.0844	.0909	.0974	.1039	.1105
11	.11809	.0708	.0767	.0826	.0885	.0944	.1005
12	.10825	.0649	.0702	.0755	.0808	.0861	.0921
13	.09992	.0599	.0649	.0699	.0749	.0799	.0850
14	.09278	.0556	.0602	.0648	.0694	.0740	.0789
16	.08119	.0486	.0526	.0566	.0606	.0646	.0691
18	.07217	.0431	.0466	.0501	.0536	.0571	.0614
20	.06495	.0389	.0421	.0453	.0485	.0517	.0553
24	.05412	.0326	.0354	.0382	.0410	.0438	.0460
27	.04811	.0288	.0312	.0336	.0360	.0384	.0409
28	.04639	.0276	.0298	.0324	.0347	.0370	.0395
30	.04330	.0260	.0282	.0304	.0326	.0348	.0368
32	.04059	.0243	.0263	.0283	.0303	.0323	.0345
36	.03608	.0216	.0234	.0252	.0270	.0288	.0307
40	.03247	.0194	.0210	.0226	.0242	.0258	.0276
44	.02952	.0177	.0192	.0207	.0222	.0237	.0251
48	.02706	.0161	.0174	.0187	.0200	.0213	.0230
56	.02319	.0138	.0149	.0160	.0171	.0182	.0197
64	.02029	.0121	.0131	.0141	.0151	.0161	.0173
72	.01804	.0107	.0115	.0123	.0131	.0139	.0153
80	.01623	.0097	.0105	.0113	.0121	.0129	.0138

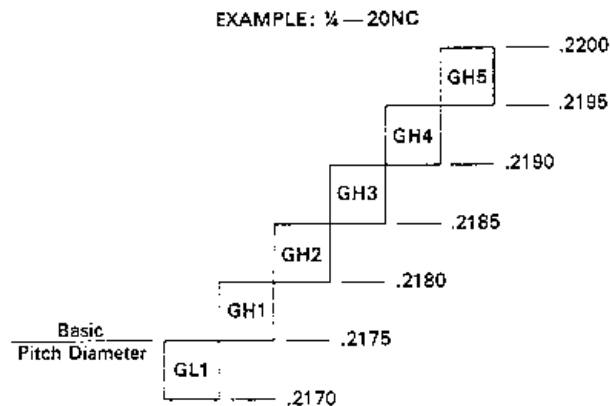

Magnetic Base Drill & Annular Cutters

Annular Cutters

Type14 & 14L M35 Cobalt	86
Type15 & 15L M42 Cobalt	86
Type13SP & 13LSP M2 HSS	86

HSS Counter Display

Annular Sets	87
Counter Displays	87

Spira-Broach™

MBD 4500	85
MBD 5500	85
MBD 6500	85
MBD 7000	85



Using the Latest Manufacturing and Design Technology to provide hole-cutting solutions

for a Wide Range of Industries: • Construction • Steel Fabrication

- Oil & Gas • Mining • Shipyards • Offshore Oil/Gas Rigs • Structural Steelwork
- Automotive • Highway and Railroad Bridgework • Petrochemical Plants • Welding Shops
- Railroads • HVAC • Machinery Installation

Magnetic Base Drill Machines



SPIRA-BROACH™ MAG-BASED DRILLS

MBD 4500 - Low Profile

Spira-Broach™ MBD 4500 Magnetic-Based Drill

- Features:**
- Quick release chuck
 - Low height for confined spaces
 - LED light for improved vision in dark areas
 - Accepts standard 3/4" shank annular cutters
 - Removable handle can be used on either side
 - 1 - 3/8" cutters capacity
 - Horsepower 1.5
 - RPM load 390
 - Weight 25 pounds
 - Magnetic Strength: 3,300 lbs.

Part No.	Description/ Size	Qty.
12400	MBD 4500	1

HEIGHT: 7-3/4"

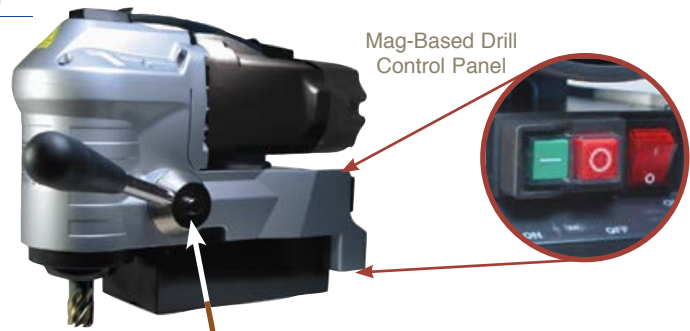

Removable handle can be used on either side.

SPIRA-BROACH™ MAG-BASED DRILLS

MBD 5500

The Spira-Broach™ MBD 5500 is an extremely light, yet powerful magnetic drill featuring the **Kwik-Lok Arbor**. These attributes give the operator the ability to cut large diameter holes up to 1-3/8" with a minimum amount of effort and time.

Features: Integral Arbor Support For Added Rigidity
New super-safe control panel which includes:

- Visual indication of status, solid state electronics.
- Time delay magnetic release
- 1-3/8 inch broaching capacity
- Lubrication reservoir
- Ultimate in versatility at 22 lbs.
- Complete with molded carrying case
- No load 550 rpm

SPECIAL FEATURES:
Kwik-Lok Arbor

SPECIAL FEATURE: Kwik-Lok Arbor

- Ability To Convert To Twist Drilling In Seconds
- Internal lubricant system

Part No.	Size	Qty.
12850	MBD5500	1
12860	1/2" Drill Chuck & Key (5500-DC)	1



MBD 6500 - Heavy Duty

Spira-Broach™ MBD 6500 variable speed Magnetic based drill.

- Features:**
- Two gear ranges
 - Morse Taper allows for quick conversion to twist drilling
 - Convenient carrying case

Technical Specifications:

- Power 1.5hp • Cutter Capacity 2"
- Morse Taper -2 • Speed Ranges - 280/ 500 rpm
- Magnet Adhesion - 2000 lbs. • Weight - 40 lbs.

Also Includes:

- Integral lubrication system • Warranty
- Allen keys • Safety strap & guard

MBD 7000 - Heavy Duty w/ Reverse

Spira-Broach™ MBD 7000 variable speed Magnetic based drill with reversible motor

- Features:**
- Reversible motor for tapping
 - Variable Speed Control
 - Morse Taper allows for quick conversion to twist drilling.
 - Two gear ranges
 - Convenient carrying case
 - 2-Inch cutter capacity

Part No.	Description	Qty.
17920	MBD 6500	1
17930	MBD 7000	1
00952	Drill Chuck with #2 Morse Taper	1



Portable Magnetic Base Drills - Spira-Broach™

SPIRA-BROACH™ ANNULAR CUTTERS

Types 13SP, Type 13LSP M2 High-Speed Steel Cutters

- High tungsten content increases abrasion resistance resulting in a tough tool with long lasting durability

M2 excellent all purpose capability

Type 14, Types 14L M35 Cobalt Cutters Gold Finish

- Similar to M2, 6% cobalt added to increase heat resistance.

M35 Increased hardness for tough jobs

Types 15, Type 15L M42 Gold Finish Super Cobalt Steel

- Molybdenum-chromium vanadium tungsten with 8% cobalt superior red hot hardness compared to conventional high speed steel.

M42 longest tool life in the most difficult applications

1" CUT DEPTH



Type 13SP
M2, Hi-Tungsten



Type 14
M35, 6% COBALT



Type 15
M42, 8% COBALT

2" CUT DEPTH



Type 13LSP
M2, Hi-Tungsten



Type 14L
M35, 6% COBALT



Type 15L
M42, 8% COBALT

Annular Cutters - Spira-Broach™ M2 M35 & M42

Type 13SP M2 Part #	Type 14 M35 Part #	Type 15 M42 Part #	Cutter Diameter	Qty.
16311	16631	14351	7/16"	1
16321	16641	14391	1/2"	1
16331	16651	14431	9/16"	1
16341	16661	14471	5/8"	1
16351	16671	14511	11/16"	1
16361	16681	14551	3/4"	1
16371	16691	14591	13/16"	1
16381	16701	14631	7/8"	1
16391	16711	14671	15/16"	1
16401	16721	14711	1"	1
16411	16731	14751	1-1/16"	1
16421	16741	14791	1-1/8"	1
16431	16751	14831	1-3/16"	1
16441	16761	14871	1-1/4"	1
16451	16771	14911	1-5/16"	1
16461	16781	14951	1-3/8"	1
16471	16791	14991	1-7/16"	1
16481	16801	15031	1-1/2"	1
16491	16811	15051	1-9/16"	1
16501	16821	15071	1-5/8"	1
16511	16831	15091	1-11/16"	1
16521	16841	15111	1-3/4"	1
16531	16851	15131	1-13/16"	1
16541	16861	15151	1-7/8"	1
16551	16871	15171	1-15/16"	1
16561	16881	15191	2"	1
16571	16891	15211	2-1/16"	1
16581	-----	15231	2-1/8"	1
16591	-----	15251	2-3/16"	1
16601	-----	15271	2-1/4"	1
16611	-----	15281	2-5/16"	1
16621	-----	15291	2-3/8"	1

Type 13LSP M2 Part #	Type 14L M35 Part #	Type 15L M42 Part #	Cutter Diameter	Qty.
16312	16632	14352	7/16"	1
16322	16642	14392	1/2"	1
16332	16652	14432	9/16"	1
16342	16662	14472	5/8"	1
16352	16672	14512	11/16"	1
16362	16682	14552	3/4"	1
16372	16692	14592	13/16"	1
16382	16702	14632	7/8"	1
16392	16712	14672	15/16"	1
16402	16722	14712	1"	1
16412	16732	14752	1-1/16"	1
16422	16742	14792	1-1/8"	1
16432	16752	14832	1-3/16"	1
16442	16762	14872	1-1/4"	1
16452	16772	14912	1-5/16"	1
16462	16782	14952	1-3/8"	1
16472	16792	14992	1-7/16"	1
16482	16802	15032	1-1/2"	1
16492	16812	15052	1-9/16"	1
16502	16822	15072	1-5/8"	1
16512	16832	15092	1-11/16"	1
16522	16842	15112	1-3/4"	1
16532	16852	15132	1-13/16"	1
16542	16862	15152	1-7/8"	1
16552	16872	15172	1-15/16"	1
16562	16882	15192	2"	1
16572	16892	15212	2-1/16"	1
16582	-----	15232	2-1/8"	1
16592	-----	15252	2-3/16"	1
16602	-----	15272	2-1/4"	1
16612	-----	15282	2-5/16"	1
16622	-----	15292	2-3/8"	1

Pilot Pins for 1" Cut Depth

Part No.	Description	Size
00902	1/4" Dia. Pin fits one 1" Depth cutters 1/2" & larger	PP1/4x1

Part No.	Description
13710	11/64" Dia. Pin fits 7/16" -- 1" Depth cutter

Pilot Pins for 2" Cut Depth

Part No.	Description	Size
00903	1/4" Dia. Pin fits two inch Depth cutters 1/2" & larger	PP 1/4x2

Part No.	Description
13720	11/64" Dia. Pin fits 7/16" -- 2" Depth cutter

SPIRA-BROACH™ ANNULAR CUTTERS & COUNTER DISPLAY

5 pcs. Spira-Broach™ Annular Cutters

These unique cutters reduce time and power requirements by cutting larger diameter holes at the periphery leaving solid slug in the center.

SPIRA-BROACH Cutters

- Give the lowest cost per hole
- Cut on curved surfaces
- Allow overlapping cuts on existing holes
- Stay sharp much longer
- Leaves a burr-free hole

SB-5 1" & 2" LENGTH

9/16", 11/16", 13/16", 15/16", 1-1/16"

Part #	Pin	Type	Metal
15301	1" Pin	15	M42
15302	2" Pin	15L	M42
16901	1" Pin	14	M35
16902	2" Pin	14L	M35
16624	1" Pin	13SP	M2 HSS
16629	2" Pin	13LSP	M2 HSS



ANNULAR CUTTER DISPLAYS

Annular Cutters

- Compact metal case attractively displays annular cutters.
- Scratch proof Lexan front reduces pilferage and keeps merchandise clean.
- Includes: 1" pins and 2" pins for each size

ANNULAR CUTTERS COUNTER DISPLAY

1/2", 9/16", 5/8", 11/16", 3/4", 13/16", 7/8", 15/16", 1", 1-1/16"

Part #	Size	Type	Qty.
00943	M-42	SB-20	15
00944	M-35	SB-20HS	14
00949	M-2 HSS	SB-20SP	13SP



Annular Cutters - Spira-Broach™ Counter Display & Sets

Acrylic Drills

Type 183-UB 98

Auger Bits

Type 940, 941 & 942 94
 Type 950, 951 952 & 953 94

Bell Hanger Bits

Type 601 97

Bolt Remover

Bolt Extractors Set 91
 Type 420 Spiral 90
 Type 421-UB Square 90

Brad Point Drills

Type 16-UB 95
 Type 16-UB Sets 95

Carbide Tipped Holecutters

Type CHC-UB 99
 Type CHD-UB 99
 Type CHC-QR 99
 Type Ext OAL- 6-1/4" 99
 Hanging Display for CHC-QR 99

Countersinks

Type 82-UB 100
 Type 90-UB 100
 Technical Diagram 101

Combined Drills & Countersinks

Type 296 101
 Combined Drill and Counter-Sink Set ... 101

Cutting Tool Lubricant

Type 11-UB 98

Glass & Tile Drills

Type 626 91

Hard Steel Drills

Type 602 Carbide Tipped 98
 Type 602-C Solid Carbide **NEW** 98

Reamers

Type 50-UB Car Reamers 92
 Type 51-UB Car Reamers 92
 Type 52-UB Hex Bridge length ... 92
 Type 53-UB Hex Car length 92
 Type 54-UB Taper Shank 93
 Type 55-UB Taper Shank 93
 Type 284-UB Hole-Hog™ 93
 Type 284-UB Hole Hog™ Sets ... 93

Left-Hand Spiral Drills

Type 420-AL Carded 89
 Type 240-AL 89
 Type 240-AL Sets 89

Pilot Drills

Type 491 97

Power Bits

Type 935 95
 Type 935 Sets 95
 Type QR-UB Extensions **NEW** 95

Sheeters Drills

Type 213 98

Step Drills - Multi-Diameter

Type 78-UB 96
 Type 78-UBN 96
 Type 78-QR 96
 Type 78-QRN 96
 Step Drill Sets 96

Twin End Drills

Type 490-G 97
 Type 490 97

Weldout Spotweld Drills & Sets

Type 492-D Weldout™ Spot weld. 102
 Type 493-D Weldout™ Spot weld. 102
 Type 493-DN TiN Coated 102
 Type 493-DB Carbide ALTiN Coated 102
 Type 493-D WO-4 Set 102
 Type 492-D WO-6 Set 102

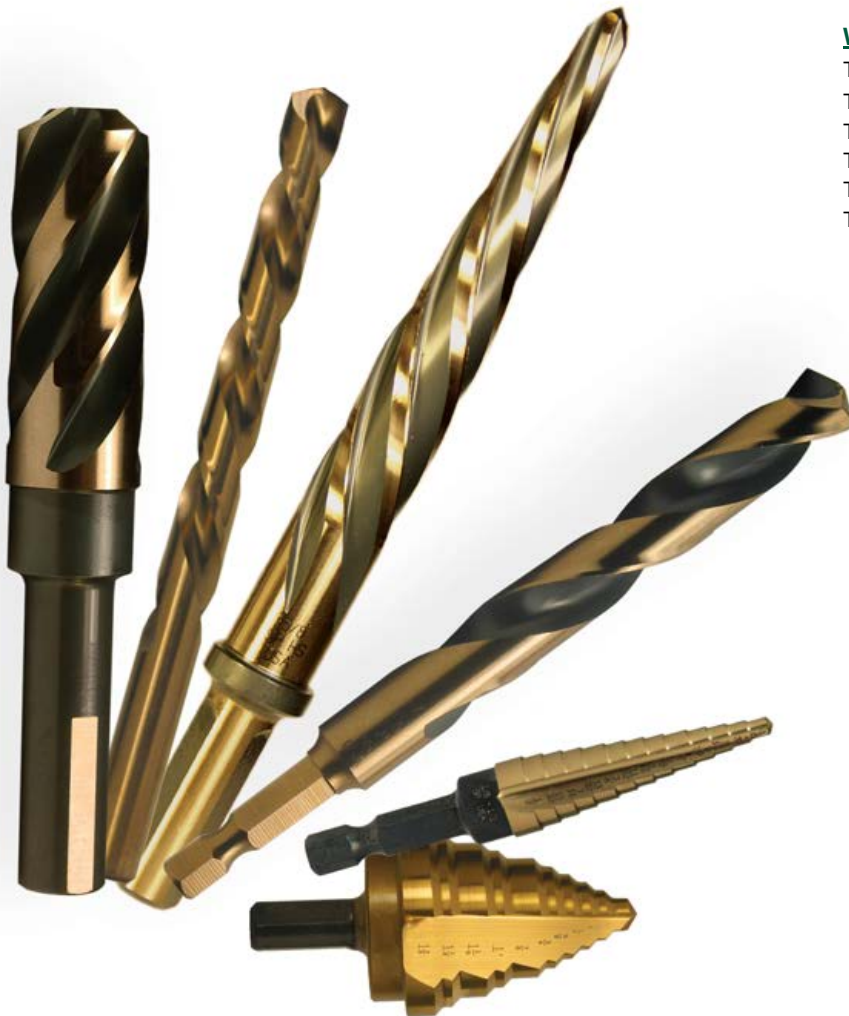

LEFT-HAND HEAVY DUTY JOBBER LENGTH DRILLS

Type 240-AL

Ultra Bor Super Premium - Left Hand Spiral

- Special Hi-Molybdenum tool steel.
- 135° split point for fast penetration and accurate starting without center punch.
- Precision ground point, flutes, body, clearance and drill diameter for the ultimate in accuracy and performance.
- Body and clearance are gold surface treated for maximum lubricity.
- Ideal for removing broken studs.



TYPE 240-AL LEFT HAND SPIRAL

Part No.	Diameter Inches	Overall Length Inches	Flute Length Inches	Qty. per/pack
92430	1/16	1-7/8	7/8	6
23150	5/64	2"	1	6
89290	3/32	2-1/4	1-1/4	6
23160	7/64	2-5/8	1-1/2	6
92440	1/8	2-3/4	1-5/8	6
92441	9/64	2-7/8	1-3/4	6
23170	5/32	3-1/8	2	6
92442	11/64	3-1/4	2-1/8	6
92450	3/16	3-1/2	2-5/16	6
92443	13/64	3-5/8	2-7/16	6
92444	7/32	3-3/4	2-1/2	6
92451	15/64	3-7/8	2-5/8	6
92460	1/4"	4"	2-3/4	6
92452	17/64	4-1/8	2-7/8	6
92453	9/32	4-1/4	2-15/16	6
23180	19/64	4-3/8	3-1/16	3
92470	5/16	4-1/2	3-3/16	3
92471	21/64	4-5/8	3-5/16	3
92472	11/32	4-3/4	3-7/16	3
92473	23/64	4-7/8	3-1/2	3
92480	3/8"	5"	3-5/8	3
92481	25/64	5-1/8	3-3/4	3
92482	13/32	5-1/4	3-7/8	3
92483	27/64	5-3/8	3-15/16	3
92490	7/16	5-1/2	4-1/16	3
92491	29/64	5-5/8	4-3/16	3
92492	15/32	5-3/4	4-5/16	3
92493	31/64	5-7/8	4-3/8	3
92500	1/2"	6"	4-1/2	3

TYPE 240-AL LEFT-HAND SPIRAL SETS

8 Pc.

Part No.	Description of Sizes	Qty of each
87650	LF-8 1/16-1/2 by 16ths	1

12 Pc.

Part No.	Description of Sizes	Qty of each
87651	LF-12 1/16-5/16 by 32nds 3/8, 7/16 & 1/2	1

13 Pc.

Part No.	Description of Sizes	Qty of each
87652	LF-13 1/16-1/4 by 64ths	1

15 Pc.

Part No.	Description of Sizes	Qty of each
87654	LF-15 1/16 - 1/2 by 32nds	1

17 Pc.

Part No.	Description of Sizes	Qty of each
87853	LF-17 1/16-1/4 by 64ths, 5/16-1/2 by 16ths	1

29 Pc.

Part No.	Description of Sizes	Qty of each
87854	LF-29 1/16-1/2 by 64ths	1

29 Pc. - Ultra Dex

Part No.	Description of Sizes	Qty of each
87859	LF-29P 1/16-1/2 by 64ths	1

Broken Bolt Remover Combo

Type 420-AL

- Carded left hand drill combined with spiral style screw extractor is ideal for removing broken studs.

Part No.	Screw Extractor Number	Description of Sizes	Qty of each
30130	EX-1	3/32 LH drill	1
30140	EX-2	1/8 LH drill	1
30150	EX-3	3/16 LH drill	1
30160	EX-4	1/4 LH drill	1
30170	EX-5	5/16 LH drill	1



PRODUCT: TIPS

Bolt Remover Sets Include BOTH Left-Hand Spiral Drills and Bolt/Screw Extractors.

HI-CARBON SCREW, STUD AND PIPE EXTRACTORS

Type 420

Screw & Pipe Extractors Hi-Carbon Steel - Spiral Style



- Remove broken screws, bolts, threaded parts, and pipes.
- Broken piece is extracted with out damage to threads.

To remove the broken threaded part:

Drill a hole in the end of the broken part (left hand spiral heavy duty drills are recommended for this drilling operation), insert extractor, then turn counterclockwise using a wrench on the exposed end of the extractor.

TYPE 420 SCREW & PIPE EXTRACTORS

Part No.	Screw Extractor Number	To remove Diameter of Screw	Diameter. of Screw Extractor Shank Point		Drill Size	No. per/pack
57100	EX-1	3/32 to 5/32	1/8	.060	5/64	5
57110	EX-2	5/32 to 7/32	3/16	.080	7/64	5
57120	EX-3	7/32 to 9/32	1/4	1/8	5/32	5
57130	EX-4	9/32 to 3/8 and 1/8 pipe	5/16	3/16	1/4	5
57140	EX-5	3/8 to 5/8 and 1/4 pipe	7/16	1/4	17/64	5
57150	EX-6	5/8 to 7/8 and 3/8 pipe	5/8	3/8	13/32	1
57160	EX-7	7/8 to 1-1/8 and 1/2 pipe	7/8	15/32	17/32	1
57170	EX-8	1-1/8 to 1-3/8 and 3/4 pipe	11/32	3/4	13/16	1
57180	EX-9	1-3/8 up and 1" pipe	1-9/32	1	1-1/8	1

TYPE 420 SCREW & PIPE EXTRACTORS - CARDED

57107	EX-1	3/32 to 5/32	1/8	.060	5/64	1
57117	EX-2	5/32 to 7/32	3/16	.080	7/64	1
57127	EX-3	7/32 to 9/32	1/4	1/8	5/32	1
57137	EX-4	9/32 to 3/8 and 1/8 pipe	5/16	3/16	1/4	1
57147	EX-5	3/8 to 5/8 and 1/4 pipe	7/16	1/4	17/64	1

Type 421-UB

Studout™ Screw, Stud and Pipe Extractors Super Premium - Square Forged Hi-Carbon Steel



- The square shape of these extractors gives the tools the ability to remove broken bolts, screws, and pipes with minimum deformation of the broken part.

- These extractors will not chew up or expand the object being removed.

To remove the broken threaded part: Drill a hole in the end of the broken part (left hand spiral heavy duty drills are recommended for this drilling operation), insert extractor, then turn counterclockwise using a wrench on the exposed end of the extractor.

TYPE 421-UB STUDOUT™ SCREW, STUD & PIPE EXTRACTOR

Part No.	Screw Extractor Number	To remove Diameter of Screw	Diameter. of Screw Extractor Shank Point		Drill Size	No. per/pack
70760	E-1	3/16-9/32	3/16	1/8	1/8	5
70770	E-2	9/32-11/32	1/4	11/64	3/16	5
70780	E-3	11/32-1/2	5/16	7/32	1/4	5
70800	E-4	1/2-3/4	3/8	9/32	5/16	5
70810	E-5	5/8-7/8	7/16	21/64	3/8	5
70820	E-6	7/8-1"	1/2	7/16	1/2	1
70830	E-7	1"-1-1/4	5/8	1/2	9/16	1
70860	E-8	1-1/8 - 1-1/2	3/4	9/16	5/8	1
70870	E-9	1-1/4 - 1-3/4	7/8	5/8	11/16	1

BOLT EXTRACTOR SETS / GLASS TILE

Type 420 -Bolt Extractor Set Type 421-UB -Bolt Extractor Set

- Fast and easy stud removal
- Left-hand spiral drills often eliminate the need for use of extractor.
- Drill loosens bolt stud with counter clockwise rotation.
- 135° split point for fast penetration and accurate starting without center punch.
- Most broken studs are work hardened during the breaking process.

TYPE 420 BOLT EXTRACTOR SETS - SPIRAL EXTRACTOR

SE-4N - Type 420

Part No.	Description of Sizes	Qty of each
47170	EX 2, 3, 4 & 5	1

SE-5N - Type 420

Part No.	Description of Sizes	Qty of each
47180	EX 1, 2, 3, 4 & 5	1

TYPE 420 BOLT EXTRACTOR SETS - LEFT HAND DRILL

BR-8 - Type 420 & 240-AL

Part No.	Description of Sizes	Qty of each
88550	EX 1, 2, 3, 4 + 3/32, 1/8, 3/16 & 1/4	1

BR-10 - Type 420 & 240-AL

Part No.	Description of Sizes	Qty of each
58510	EX 1, 2, 3, 4 & 5 + 3/32, 1/8, 3/16, 1/4, 5/16	1



BR-10

TYPE 421-UB BOLT EXTRACTOR SETS

SQE-4 - Type 421-UB

Part No.	Description of Sizes	Qty of each
70840	EX 2, 3, 4 & 5	1

TYPE 421-UB BOLT EXTRACTOR SETS - LEFT HAND DRILL

BR-8SQ - Type 421-UB & 240-AL

Part No.	Description of Sizes	Qty of each
70850	EX 1, 2, 3 & 4 + 1/8, 3/16, 1/4 & 5/16	1

GLASS & TILE DRILLS

Type 626

Carbide Tipped with Spear Point

- Designed for drilling in glass, tile, mirrors and ceramic materials.
- Spear point allows clean penetration with reduced cutting pressure and breakout.
- Carbide tip insures long tool life.



TYPE 626 CARBIDE TIPPED

Part #	Size Inches
56510	1/8
56520	5/32
56530	3/16
56540	1/4
56550	5/16
56560	3/8
56570	1/2

Individually packaged in clear hanging tubes.

CAR REAMERS & HEX NUT REAMERS

Part #	Diameter Inches	Point Diameter	Min. Starting Hole Size	Overall Length	Shank Dia.
06390	3/8	0.250	5/16	4-5/8	3/8
06400	1/2	0.281	3/8	5-7/8	1/2
06410	9/16	0.343	7/16	5-7/8	1/2
06420	5/8	0.343	7/16	6-3/8	1/2
06430	11/16	0.375	15/32	6-3/8	1/2
06440	3/4	0.406	1/2	6-7/8	1/2
06450	13/16	0.468	35/64	6-7/8	1/2
06460	7/8	0.500	19/32	6-7/8	1/2
06470	15/16	0.585	5/8	6-7/8	1/2
06480	1"	0.594	7/8	6-7/8	1/2
06484	1-1/4	0.719	1"	6-7/8	1/2

SET	TYPE 50-UB	Includes
12270	CR-4SP	3/8, 1/2, 5/8, 3/4

Part #	Diameter Inches	Point Diameter	Min. Starting Hole Size	Overall Length	Shank Dia.
06381	5/16	0.215	17/64	4-5/8	5/16
06391	3/8	0.250	5/16	4-5/8	3/8
06501	7/16	0.250	3/8	5-7/8	7/16
06401	1/2	0.281	3/8	5-7/8	1/2
06411	9/16	0.343	7/16	5-7/8	1/2
06421	5/8	0.343	7/16	6-3/8	1/2
06432	0.652	0.375	15/32	6-3/8	1/2
06431	11/16	0.375	15/32	6-3/8	1/2
06441	3/4	0.406	1/2	6-7/8	1/2
06531	0.776	0.406	1/2	6-7/8	1/2
06451	13/16	0.468	35/64	6-7/8	1/2
06461	7/8	0.500	19/32	6-7/8	1/2
06471	15/16	0.585	5/8	6-7/8	1/2
06481	1	0.594	7/8	6-7/8	1/2
06491	1-1/16	0.807	7/8	6-7/8	1/2
06482	1-1/4	0.719	1"	6-7/8	1/2

SET	TYPE 51-UB	Includes
12271	CR-4FS	3/8, 1/2, 5/8, 3/4
12281	SM-4FS	5/16, 3/8, 7/16, 1/2

Type 50-UB Car Reamers, Standard Flute 3-Flats on Shank



- These reamers are especially designed for the reaming of structural steel plates commonly found in truck frames, rail cars, bridges, and pressure vessels.
- For use in enlarging previously formed or drilled holes.
- All tools are constructed with left-hand spiral and right-hand cut.

Type 51-UB Car Reamers - Fast Spiral Hole Buster™, Super Premium 3-Flats on Shank



- Special Hi-Tungsten tool steel, gold surface treated body and clearance for maximum lubricity.
- These reamers are especially designed for the reaming of structural steel plates commonly found in truck frames, rail cars, bridges, and pressure vessels.
- The 51-UB, with the fast spiral, is the more aggressive of the two styles. It also will fit the needs of users who prefer a stop collar.



TYPE 52-UB BRIDGE LENGTH

Part #	Diameter Inches	Hex Shank Inches	Flute Length	Overall Length	No. per/pack
20480	9/16	1-1/16	5-1/8	6-7/8	1
20490	5/8	1-1/16	6-1/8	7-7/8	1
20510	11/16	1-1/16	7-1/8	9-1/4	1
20520	3/4	1-1/4	7-3/8	9-3/8	1
20530	13/16	1-1/4	7-3/8	9-3/8	1
20540	7/8	1-7/16	7-3/8	9-3/8	1
20550	15/16	1-7/16	7-3/8	9-3/8	1
20560	1	1-7/16	7-3/8	9-3/8	1
20570	1-1/16	1-5/8	7-3/8	9-3/8	1
20500	1-1/8	1-5/8	7-3/8	9-3/8	1
20580	1-3/16	1-13/16	7-3/8	9-3/8	1
20590	1-5/16	2	7-3/8	10	1
21120	1-3/8	2	7-3/8	10	1
21130	1-7/16	2	7-3/8	10	1
21140	1-1/2	2	7-3/8	10	1
21150	1-9/16	2	7-3/8	10	1
21160	1-5/8	2	7-1/2	10	1

Type 52-UB -Bridge Length Type 53-UB -Car Length Hex Nut Reamers Black & Gold Finish HSS- Spiral Flute

- Designed for aligning and enlarging holes in structural steel applications..
- Gold treated for maximum lubricity.

TYPE 53-UB CAR LENGTH

Part #	Diameter Inches	Hex Shank Inches	Flute Length	Overall Length	No. per/pack
35580	9/16	1-1/16	4	5-1/2	1
35590	5/8	1-1/16	4-1/2	6	1
35610	11/16	1-1/16	4-1/2	6-3/8	1
35620	3/4	1-1/4	5	7	1
35630	13/16	1-1/4	5	7	1
35640	7/8	1-7/16	5	7	1
35650	15/16	1-7/16	5	7	1
35660	1	1-7/16	5	7	1
35670	1-1/16	1-5/8	5	7	1
35600	1-1/8	1-5/8	5	7	1
35680	1-3/16	1-13/16	5	7	1
35690	1-5/16	2	5	7-7/8	1

BRIDGE REAMERS & HOLE HOG™

Type 54-UB -Straight Flute Type 55-UB -Spiral Flute

Bridge Reamers - Straight & Spiral Flutes - Taper Shank High-Speed Steel, Surface Treated

- These special Hi-Tungsten tool steel reamers with gold surface treated body and clearance are designed to be used with Taper shank equipment.
- They are available in both straight and spiral flute configuration and are designed for heavy-duty reaming as encountered in the fabrication of structural steel assemblies, bridge erection, and ship construction.



TYPE 54-UB STRAIGHT FLUTE

Part #	Diameter Inches	Flute Length	Overall Length	Morse Taper	Qty. per/pack
81630	7/16	4-3/8	8-1/4	#2	1
81640	1/2	5-1/8	9	#2	1
81650	9/16	5-1/8	9	#2	1
81660	5/8	6-1/8	10	#2	1
81670	11/16	7-1/8	11-3/4	#3	1
81680	3/4	7-3/8	12	#3	1
81690	13/16	7-3/8	12	#3	1
81700	7/8	7-3/8	12	#3	1
81710	15/16	7-3/8	12	#3	1
81720	1	7-3/8	12	#3	1
81730	1-1/16	7-3/8	12	#3	1
81740	1-1/8	7-3/8	12	#3	1
81750	1-3/16	7-3/8	12	#3	1
81760	1-1/4	7-3/8	13	#4	1
81770	1-5/16	7-3/8	13	#4	1

TYPE 55-UB SPIRAL FLUTE

Part #	Diameter Inches	Flute Length	Overall Length	Morse Taper	Qty. per/pack
83310	7/16	4-3/8	8-1/4	#2	1
83320	1/2	5-1/8	9	#2	1
83330	9/16	5-1/8	9	#2	1
83340	5/8	6-1/8	10	#2	1
83350	11/16	7-1/8	11-3/4	#3	1
83360	3/4	7-3/8	12	#3	1
83370	13/16	7-3/8	12	#3	1
83380	7/8	7-3/8	12	#3	1
83390	15/16	7-3/8	12	#3	1
83400	1	7-3/8	12	#3	1
83410	1-1/16	7-3/8	12	#3	1
83420	1-1/8	7-3/8	12	#3	1
83430	1-3/16	7-3/8	12	#3	1
83440	1-1/4	7-3/8	13	#4	1
83450	1-5/16	7-3/8	13	#4	1

Type 284-UB

Hole Hog™ 4-Flute Core Drill Super Premium, Flats on Shank

- This tool is designed exclusively for enlarging existing holes.
- The 4-flute design eliminates the catching and hogging-in experienced with standard S & D drills when breaking through thinner materials such as truck frames.
- These core drills may replace tapered reamers in many applications.



TYPE 284-UB FRACTIONAL

Part #	Diameter Inches	Minimum Starting Hole Size	Overall Length Inches	Flute Length Inches	Qty. per/pack
22030	3/8	1/4	4-5/16	1-7/8	1
22040	1/2	5/16	4-5/16	1-7/8	1
22060	9/16	3/8	4-5/16	1-7/8	1
22080	5/8	25/64	4-5/16	1-7/8	1
22100	11/16	7/16	4-5/16	1-7/8	1
22120	3/4	15/32	4-5/16	1-7/8	1

Hole Hog™ Sets
1/2" Shank 3-flats on Shank 4-Flute Core Drill Ultra Bor Super Premium

- A selection of core drills and companion (minimum starting hole size) pilot drills in a black steel index.



TYPE 284-UB SETS

SP-8HH Set contains 1 each:

284-UB core drill sizes 3/8, 1/2, 5/8 & 3/4.
250-UB drill sizes 1/4, 5/16, 25/64 & 15/32

Part No. 38880

SP-6HHL Set contains 1 each:

284-UB core drill sizes 1/2, 5/8 & 3/4.
250-UB drill sizes 5/16, 25/64 & 15/32.

Part No. 38870

SP-6HHS Set contains 1 each:

284-UB core drill sizes: 3/8, 1/2 & 5/8.
250-UB drill sizes 1/4, 5/16 & 25/64

Part No. 38860

AUGER BITS CARBIDE

Type 940 -12" Bits Type 941 -18" Bits Type 942 -24" Bits Carbide-Tipped Auger Bit

- A carbide cutting tip combined with a hardened steel cutting edge, allows it to bore holes in all types of wood quickly.
- A clean, smooth hole is provided.
- Requires less torque to operate and can be used with electric, air or gasoline powered drill motors, and impact wrenches.
- The carbide cutter is brazed onto the steel body and the hardened steel cutting edge can be resharpened.



TYPE 940 12" AUGER BITS

Part No.	Description of Sizes
51300	1/2
51310	9/16
51320	5/8
51330	11/16
51340	3/4
51350	13/16
51360	7/8
51370	15/16
51380	1"
51390	1-1/16
51400	1-1/8

TYPE 941 18" AUGER BITS

Part No.	Description of Sizes
51410	1/2
51420	9/16
51430	5/8
51440	11/16
51450	3/4
51460	13/16
51470	7/8
51480	15/16
51490	1"
51500	1-1/16
51510	1-1/8

TYPE 942 24" AUGER BITS

Part No.	Description of Sizes
51520	1/2
51530	9/16
51540	5/8
51550	11/16
51560	3/4
51570	13/16
51580	7/8
51590	15/16
51600	1"
51610	1-1/16
51620	1-1/8

STANDARD WOOD AUGERS

Types 950 -9" Bits , Type 951 -16" Bits , Type 952 -18" Bits , Type 953 -24" Bits

- High quality auger bits with hex shanks produced from alloy tool steel.
- For deep drilling wood applications, quickly and easily drill holes in all types of wood products.



TYPE 950 9" AUGER BITS

Part No.	Description of Sizes
53200	3/8"
53210	1/2"
53220	9/16"
53230	5/8"
53240	11/16"
53250	3/4"
53260	7/8"
53270	15/16"
53280	1"
53290	1-1/8"

TYPE 951 16" AUGER BITS

Part No.	Description of Sizes
53300	3/8"
53310	1/2"
53320	9/16"
53330	5/8"
53340	11/16"
53350	3/4"
53360	7/8"
53370	15/16"
53380	1"
53390	1-1/8"

TYPE 952 18" AUGER BITS

Part No.	Description of Sizes
53400	3/8"
53410	1/2"
53420	9/16"
53430	5/8"
53440	11/16"
53450	3/4"
53460	7/8"
53470	15/16"
53480	1"
53490	1-1/8"

TYPE 953 24" AUGER BITS

Part No.	Description of Sizes
53500	3/8"
53510	1/2"
53520	9/16"
53530	5/8"
53540	11/16"
53550	3/4"
53560	7/8"
53570	15/16"
53580	1"
53590	1-1/8"

BRAD POINT DRILLS

Type 16-UB

Jobber Length - Burrouter™ Brad Point Super Premium

- These high performance drills made from Hi-Moly tool steel will cut holes in wood or plastics and leave no burr.
 - The special **BURROUT™** point cuts at the circumference of the hole to avoid the break through burr problems common with standard point drills.
- (Sizes 7/16" and 1/2" have 3/8" Reduced Shanks)



Part No.	Diameter Inches	Overall Length Inches	Flute Length Inches	Qty. per/pack
01041	5/64	2	1	12
01051	3/32	2 1/4	1 1/4	12
01061	7/64	2 5/8	1 1/2	12
01071	1/8	2 3/4	1 5/8	12
01081	9/64	2 7/8	1 3/4	12
01091	5/32	3 1/8	2	12
01101	11/64	3 1/4	2 1/8	12
01111	3/16	3 1/2	2 5/16	12
01131	7/32	3 3/4	2 1/2	12
01151	1/4	4	2 3/4	12
01191	5/16	4 1/2	3 3/16	6
01231	3/8	5	3 5/8	6
01271	3/8	5 1/2	4 1/16	6
01311	3/8	6	4 1/2	6

TYPE 16-UB BURROUT™ SETS

BF-10

Part No.	Description of Sizes	Qty of each
42001	5/64-3/16 by 64ths + 7/32, 1/4	1

BF-14

Part No.	Description of Sizes	Qty of each
42031	5/64-3/16 by 64ths + 7/32, 1/4-1/2 by 16ths	1

TYPE 935 1/4" HEX SHANK

Part No.	Diameter Inches	Qty. per/pack
52005	1/4	1
52015	5/16	1
52025	3/8	1
52035	7/16	1
52045	1/2	1
52055	9/16	1
52065	5/8	1
52075	11/16	1
52085	3/4	1
52095	13/16	1
52105	7/8	1
52115	15/16	1
52125	1 INCH	1
52135	1-1/8	1
52145	1-1/4	1
52155	1-3/8	1
52165	1-1/2	1

EXTENSIONS

Part No.	Size	Qty. per/pack
27555	6"	1
52175	12"	1

TYPE QR-UB EXTENSIONS



- One handed operation – Simply push your PTA into the extension and it will automatically load and lock the accessory.
- Patented All Hex connection system will hold any 1/4" hex shape including, Power Groove and Notched product
- Patented All Hex connection system holds the accessory without any wobble or play. Tight fit for a professional feel.
- **Made in the USA.**
- **Not intended for Impact Tools.**



Part No.	Size	Qty. per/pack
34821	3" Quick release Extension	1
34831	6" Quick release Extension	1
34841	12" Quick release Extension	1

POWER BITS

Type 935

Quick Release 1/4" Hex Shank - Power Bits

- Cuts clean accurate holes in all soft and hard woods plus foam core, plastic, many non-metallic building siding, and foam insulation.

TYPE 935 1/4" HEX SHANK SETS

EASY-CUT 4 PIECE SET

One each: 3/8, 1/2, 5/8 & 3/4 in plastic pouch.
Part No. 52185

EASY-CUT 6 PIECE SET

One each: 3/8, 1/2, 5/8, 3/4, 7/8 & 1" in plastic pouch.
Part No. 52195

EASY-CUT 13 PIECE SET

One each: 1/4, 5/16, 3/8, 7/16, 1/2, 9/16, 5/8 11/16, 3/4, 13/16, 7/8, 15/16 & 1" in plastic pouch.
Part No. 52205

EASY-CUT 6" - 12" EXTENSION

For all bits with 1/4" shanks.
For those jobs that require extra reach.
With Allen wrench.



STEP DRILLS ULTRA BIT™ MULTI-DIAMETER

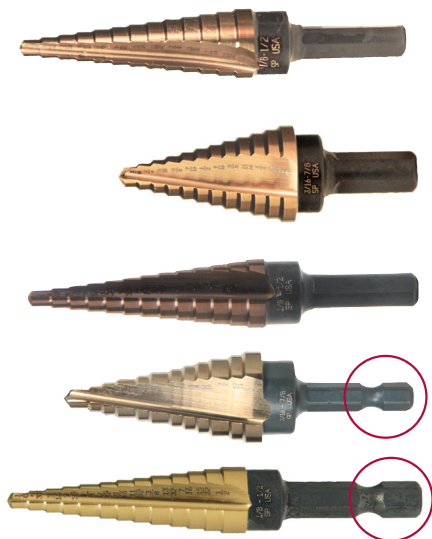

Type 78-UB Gold Oxide, 3-flats on Shank - Blister pak

- Special Axial and Radial flute design increases work piece penetration.
- Dual flute construction drills clean accurate holes in thin materials, quickly and easily.

Type 78-UBN Titanium Nitride Coated, 3-flats on Shank - Blister pak

- Titanium nitride coated tools last six times longer than uncoated tools.
 - Cutting edge stays sharper longer.
 - Titanium nitride coating reduces friction.

Type 78-ACN Titanium Carbon Nitride Coated, 3-flats on Shank - Blister pak

- 2 - 4x the tool life of Titanium Nitride coated tools.
- Improved lubricity for better performance in steel and aluminum.
- Twice as hard as titanium nitride coating.

Ultra Bit™ Multi-Diameter - Quick Release

Type 78-QR Gold Oxide

- Use for all thin metals, rigid plastics, wood or composite materials with a thickness equal to or less than the step thickness.
- Split point self centers and easily starts with no pilot hole required.

Type 78-QRN Titanium Nitride Coated

- Titanium nitride coated tools last six times longer than uncoated tools.
 - Cutting edge stays sharper longer.
 - Titanium nitride coating reduces friction.
- **Made in the U.S.A.**

TYPE B78-UB, B78-UBN, B78-ACN 3-FLATTED SHANK

B78-UB Gold Oxide Part #	B78-UBN Titanium Nitride Part #	B78-ACN Titanium Carbon Nitride Part #	Size	Hole Sizes	No. Range	Shank Size	Step Increments	Step Thickness
00700	69130	65300	1	13	1/8 - 1/2"	1/4	1/32	1/8
00704	69180	65310	2	8	9/16 - 1"	3/8	1/16	5/32
00703	69160	65320	3	9	1/4 - 3/4"	3/8	1/16	5/32
00701	69140	65330	4	6	3/16 - 1/2"	1/4	1/16	3/8
00714	69170	65340	7	11	1/4 - 7/8"	3/8	1/16	1/16
00702	69150	65350	8	12	3/16 - 7/8"	3/8	1/16	1/8
00770	69270	----	9	3	7/8 - 1-7/32"	3/8	7/8	----
00713	69200	65370	11	2	7/8 - 1-1/8"	3/8	27/64	9/64
00711	69220	65380	12	10	1/4 - 1-3/8"	3/8	1/8	*SEE NOTE
00719	69210	65400	1/4 A	16	1/4 - 1-1/8"	3/8	1/16	1/16
00710	69190	65390	13/16	10	13/16 - 1-3/8"	1/2	1/32	5/32

NOTE: Parts # 00711, 69220, 65380 -- 7/8", 1 - 1/8" (1/2" and 3/4" conduit)

3 & 4 PC. SETS

Gold Oxide	Titanium Nitride	Titanium Carbon Nitride	Size	Hole Sizes	No. Range	Shank Size	Step Increments	Step Thickness
00741	69250	65430		1/8 - 1/2", 3/16 - 1/2"	& 1/4 - 3/4"			(#1, #4, #3)
00721	69230	65410		1/8 - 1/2", 3/16 - 1/2"	& 3/16 - 7/8"			(#1, #4, #8)
00731	69240	65420		1/8 - 1/2", 3/16 - 1/2"	& 9/16 - 1"			(#1, #4, #2)
4pc. 00781	68781	65440		1/8 - 1/2", 1/4 - 3/4", 1/4 - 7/8", 7/8 - 1-1/8"				(#1, #3, #7, #11)

TYPE 78-QR, 78-QRN QUICK RELEASE

78-QR Gold Oxide Part #	78-QRN Titanium Nitride Part #		Size	Hole Sizes	No. Range	Shank Size	Step Increments	Step Thickness
01401	68491		1	13	1/8 - 1/2"	1/4	1/32	1/8
01411	68534		2	8	9/16 - 1"	1/4	1/16	5/32
01404	68521		3	9	1/4 - 3/4"	1/4	1/16	5/32
01402	68501		4	6	3/16 - 1/2"	1/4	1/16	3/8
01412	68541		7	11	1/4 - 7/8"	1/4	1/16	1/16
01403	68511		8	12	3/16 - 7/8"	1/4	1/16	1/8
01419	68554		9	3	7/8 - 1-7/32"	1/4	7/8	----
01409	68531		11	2	7/8 - 1-1/8"	1/4	27/64	9/64
01414	68524		12	10	1/4 - 1-3/8"	1/4	1/8	*SEE NOTE
01413	68551		1/4 A	16	1/4 - 1-1/8"	1/4	1/16	1/16

NOTE: Parts # 01414, 68524 -- 7/8", 1 - 1/8" (1/2 and 3/4" conduit)

3 PC. SETS

Gold Oxide	Titanium Nitride	Size	Hole Sizes	No. Range	Shank Size	Step Increments	Step Thickness
01451	68571		1/8 - 1/2", 3/16 - 1/2"	& 1/4 - 3/4"			(#1, #4, #3)
01441	68561		1/8 - 1/2", 3/16 - 1/2"	& 3/16 - 7/8"			(#1, #4, #8)
01461	68581		1/8 - 1/2", 3/16 - 7/8"	& 7/8 - 1-1/8"			(#1, #4, #11)

All tools individually packed in clear tubes

TWIN END & PILOT DRILLS, BELL HANGER BITS

TYPE 490-G -SUPER PREMIUM TYPE 490 -HEAVY DUTY

Twin End - Ultra Bor Super Premium 135° Split Point

- Special Hi-Molybdenum tool steel, gold surface treated for maximum lubricity.
- 135° split point for fast penetration and accurate starting without a center punch.



TYPE 490-G FRACTIONAL

Part No.	Diameter Inches	Overall Length Inches	Flute Length Inches	Qty. per/pack
95090	3/32	1-3/4	9/16	12
95080	7/64	1-15/16	5/8	12
95980	1/8	1-15/16	5/8	12
95070	9/64	2	5/8	12
95060	5/32	2-1/8	5/8	12
95050	3/16	2-5/16	5/8	12
95040	7/32	2-9/16	3/4	12
95030	1/4	2-5/8	13/16	12

Twin End - Heavy-Duty -135° Split Point

- This twin end drill has wide applications in drilling any thin sheet metal or wood.
- Automotive body shops will find twin end drills especially productive.
- Black Oxide finish.



TYPE 490 FRACTIONAL

Part No.	Diameter Inches	Overall Length Inches	Flute Length Inches	Qty. per/pack
28470	3/32	1-3/4	9/16	12
28480	7/64	1-15/16	5/8	12
28490	1/8	1-15/16	5/8	12
28500	9/64	2	5/8	12
28510	5/32	2-1/8	5/8	12
28530	3/16	2-5/16	5/8	12
28550	7/32	2-9/16	3/4	12
28570	1/4	2-5/8	13/16	12

TYPE 490-G WIRE

Part No.	Diameter Wire Gauge	Overall Length Inches	Flute Length Inches	Qty. per/pack
95020	10	2-5/16	5/8	12
95010	11	2-5/16	5/8	12
95000	20	2-1/8	5/8	12
94990	30	2	5/8	12

TYPE 490 WIRE

Part No.	Diameter Wire Gauge	Overall Length Inches	Flute Length Inches	Qty. per/pack
27940	10	2-5/16	5/8	12
27950	11	2-5/16	5/8	12
28040	20	2-1/8	5/8	12
28140	30	2	5/8	12

PILOT DRILLS

Type 491

Pilot Drills For HSS Hole Saws



Part #	Size Inches	Description	Diameter Inches	Overall Length Inches	Qty. per/pack
95100	1/4 x 4	Universal pilot with two whistle notch flats. Fits most hole saws needing 4" length - Bright finish	1/4	4	12
95101	1/4 x 3	Fits most arbors with one set screw: Lennox, Starrett, Morse, Milwaukee & more. One flat on shank. Bright finish.	1/4	3	12
95102	1/4 x 4L	Three long flats on shank allow for set screw and eliminate slippage Fits through the arbor drive. (Replaces Lennox and others). Surface treated.	1/4	4	12
95103	1/4 x 3L	Same as 95101 except surface treated. (Replaces Lennox and others).	1/4	3	12
95104	1/4 x 4-1/4L	Three long flats on shank allow for set screw and eliminate slippage Fits through the arbor drive. (Replaces Lennox L-series). Black Surface treated.	1/4	4-1/4"	12

BELL HANGER BITS

Type 601

Carbide Tipped, Alloy Steel Shanks



(Hole in flute for pulling wire)

- Flutes are designed for quick chip clearance.
- Recommended for all telephone, electrical, cable TV. installers.
- Excellent for drilling through wood, metal lathe, plaster, wallboard.

Part No.	Diameter Inches	Shank Diameter Inches	Overall Length Inches	Qty. per/pack
32000	1/4	1/4	12	1
32010	5/16	5/16	12	1
32020	3/8	3/8	12	1
32030	1/2	3/8	12	1
32040	1/4	1/4	18	1
32050	5/16	5/16	18	1
32060	3/8	3/8	18	1
32070	1/2	3/8	18	1
32080	1/4	1/4	24	1
32090	5/16	5/16	24	1

Part No.	Diameter Inches	Shank Diameter Inches	Overall Length Inches	Qty. per/pack
32100	3/8	3/8	24	1
32110	1/2	3/8	24	1
32120	1/4	1/4	36	1
32130	5/16	5/16	36	1
32140	3/8	3/8	36	1
32150	1/2	3/8	36	1
32160	1/4	1/4	48	1
32170	5/16	5/16	48	1
32180	3/8	3/8	48	1
32190	1/2	3/8	48	1



Specialty Tools

ACRYLIC, HARD STEEL, SHEETERS DRILLS & CUTTING TOOL LUBRICANT

Type 183-UB

Acrylic Drills with Chipfree™ Point Super Premium

- Super **CHIPFREE™** point is precision ground at a 60° angle for gradual penetration to avoid cracking and chipping of the acrylic material.
- Special 0° rake angle on cutting edge eliminates “grabbing” when drill breaks through plastic, acrylic, or laminate surfaces.
- All sizes over 1/4” have 1/4” shanks



TYPE 183-UB FRACTIONAL

Part No.	Diameter Inches	Overall Length Inches	Flute Length Inches	Qty. per/pack
32260	3/32	2-1/4	1-1/4	12
31500	1/8	2-5/8	1-5/8	12
31510	5/32	3	2	12
31520	3/16	3-3/8"	2-5/16"	12
32210	13/64	3-21/32	2-7/16	12
32220	7/32	3-13/16	2-1/2	12
31530	1/4	3-15/16	2-3/4	12
32240	9/32	3-9/16	1-31/32	12
32230	19/64	3-3/8"	2-1/16"	12
31540	5/16	3-13/16	2-3/16	6
32290	11/32	4-1/32	2-11/32	6
31550	3/8	4-1/4	2-9/16	6
32250	25/64	4-11/32"	2-5/8"	6
32460	13/32	4-15/32	2-3/4	6
31560	7/16	4-11/16	2-15/16	6
32470	15/32	4-7/8	3-1/8	6
31570	1/2	5	3-7/32	6

Type 213

Sheeters Drill - Black Surface Treated

Heavy-duty 135° split point high-speed steel drill is excellent for drilling sheet metal and corrugated construction panels.



TYPE 213 WIRE

Part #	Diameter Wire Gauge	Overall Length Inches	Flute Length Inches	Qty. per/pack
27010	1	3	1-5/16	12
27030	1	4-1/2	1-5/16	12
27040	1	6	1-5/16	12

CUTTING TOOL LUBRICANT

Type 11-UB Ultra S/P™ Super Premium High Viscosity

- Super concentrated no run formula.
- Clings to vertical surfaces for continual lubrication.
- Virtually smoke free in even the most heat prone applications.
- Contains no ozone depleting substances.

This fluid will extend tool life and yield a super machined finish.



Type 602-C Solid Carbide

Solid Carbide Drills, Straight Flute



- Excellent for removing broken screw extractors, tap and drills bits. For use in extremely hard and difficult to machine materials. Produces accurate holes.



Type 602-C

Designed for drilling holes in 48-65 RC hardened steel, stainless steels, and high temperature alloys.

Part No.	Diameter Inches	Shank Diameter Inches	Overall Length Inches	Qty. per/pack
36173	1/16	1/16	1-5/8	1
36193	3/32	3/32	1-3/4	1
36213	1/8	1/8	1-7/8	1
36233	5/32	5/32	2-1/16	1
36253	3/16	3/16	2-3/16	1
36273	7/32	7/32	2-3/8	1
36293	1/4	1/4	2-1/2	1
36313	9/32	9/32	2-11/16	1
36333	5/16	1/4	2-13/16	1
36353	11/32	11/32	3	1
36373	3/8	3/8	3-1/8	1
36393	13/32	13/32	3-5/16	1
36413	7/16	7/16	3-7/16	1
36433	15/32	15/32	3-5/8	1
36453	1/2	1/2	3-3/4	1
36473	5/8	5/8	4	1
36483	3/4	3/4	4	1

Type 602 Carbide Tipped Hard Steel Drills Carbide Tipped, Straight Flute

- Used for drilling broken studs, springs, bolts, die sections, broken easy outs, extra tough or exotic metals, and brake drums.



Type 602

These drills are made for use in drilling hardened steel in the range of 48 to 65 Rockwell C.

Part No.	Diameter Inches	Shank Diameter Inches	Overall Length Inches	Qty. per/pack
32300	1/8	1/8	2-3/4	1
32310	5/32	5/32	3	1
32320	11/64	11/64	3	1
32330	3/16	3/16	3	1
32340	7/32	7/32	4	1
32350	1/4	1/4	4	1
32360	1/4	1/4	6	1
32370	9/32	9/32	4	1
32380	5/16	1/4	4	1
32390	5/16	5/16	6	1
32400	3/8	1/4	4	1
32410	3/8	3/8	6	1
32420	7/16	3/8	6	1
32430	1/2	1/2	6	1
32440	9/16	1/2	6	1
32450	5/8	1/2	6	1

Part No.	Size MM	Bottles Per Case	Weight Per Case
96050	12 - 4 OZ.	12	4.4 Lbs./2 Kgs.
96060	48 - 4 OZ.	48	18 Lbs./8.2 Kgs.
96070	12 - 16 OZ.	12	15 Lbs./6.8 Kgs.

Part No. 96071 is a self selling display with an attractive attention getting decal applied to the inside of the display flap. Dispose of display when empty.

CARBIDE TIPPED HOLECUTTERS

Type CHC-UB Carbide Tipped Holecutters CUTS UP TO 3/16"

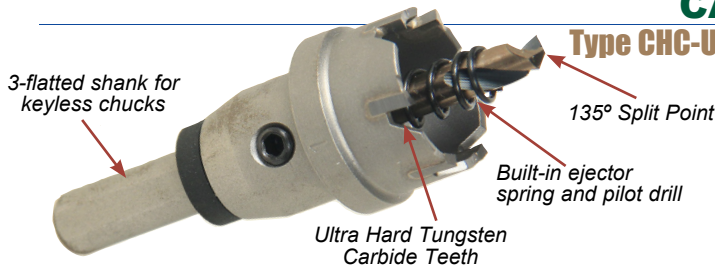

Part#	Diameter Inches	Shank Diameter	Qty. per/pack
62000	9/16	3/8"	1
62010	5/8	3/8"	1
62020	11/16	3/8"	1
62030	3/4	3/8"	1
62040	13/16	3/8"	1
62050	7/8	3/8"	1
62060	15/16	3/8"	1
62070	1"	3/8"	1
62080	1-1/16	3/8"	1
62090	1-1/8	3/8"	1
62100	1-3/16	3/8"	1
62110	1-1/4	3/8"	1
62120	1-5/16	3/8"	1
62130	1-3/8	3/8"	1

Part#	Diameter Inches	Shank Diameter	Qty. per/pack
62140	1-7/16	3/8"	1
62150	1-1/2	3/8"	1
62160	1-9/16	3/8"	1
62170	1-5/8	3/8"	1
62180	1-11/16	3/8"	1
62190	1-3/4	3/8"	1
62200	1-13/16	3/8"	1
62210	1-7/8	3/8"	1
62220	1-15/16	3/8"	1
62230	2"	3/8"	1
62240	2-1/16	3/8"	1
62250	2-1/8	3/8"	1
62260	2-3/16	3/8"	1
62270	2-1/4	3/8"	1

Part#	Diameter Inches	Shank Diameter	Qty. per/pack
62280	2-5/16	3/8"	1
62290	2-3/8	3/8"	1
62300	2-7/16	3/8"	1
62310	2-1/2	3/8"	1
62320	2-9/16	3/8"	1
62330	2-5/8	3/8"	1
62340	2-11/16	1/2"	1
62350	2-3/4	1/2"	1
62360	2-13/16	1/2"	1
62370	2-7/8	1/2"	1
62380	2-15/16	1/2"	1
62390	3"	1/2"	1
62400	3-1/4	1/2"	1
62410	3-1/2	1/2"	1
62420	3-3/4	1/2"	1
62430	4"	1/2"	1
62440	4-1/4	1/2"	1
62450	4-1/2	1/2"	1
62460	4-3/4	1/2"	1
62470	5"	1/2"	1
62480	PILOT DRILL		1
62490	SCREW		1
62500	SPRING		1

Type CHD-UB Deephole Carbide Tipped Holecutters CUTS UP TO 1"

- Produces overlapping and interrupted holes easily
- Cuts 3 times faster than bi-metal hole saws.

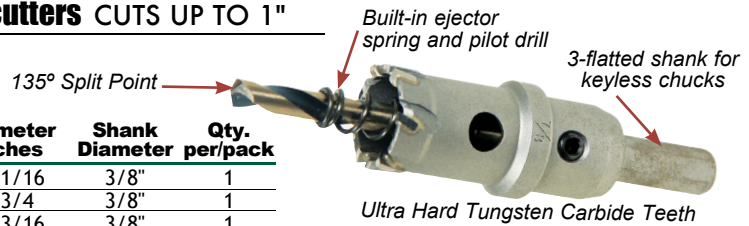

Part#	Diameter Inches	Shank Diameter	Qty. per/pack
63990	9/16	3/8"	1
64000	5/8	3/8"	1
64010	11/16	3/8"	1
64020	3/4	3/8"	1
64030	13/16	3/8"	1
64040	7/8	3/8"	1
64050	15/16	3/8"	1
64060	1"	3/8"	1
64070	1-1/16	3/8"	1
64080	1-1/8	3/8"	1
64090	1-3/16	3/8"	1
64100	1-1/4	3/8"	1
64110	1-5/16	3/8"	1
64120	1-3/8	3/8"	1
64130	1-7/16	3/8"	1
64140	1-1/2	3/8"	1
64150	1-9/16	3/8"	1
64160	1-5/8	3/8"	1

Part#	Diameter Inches	Shank Diameter	Qty. per/pack
64170	1-11/16	3/8"	1
64180	1-3/4	3/8"	1
64190	1-13/16	3/8"	1
64200	1-7/8	3/8"	1
64210	1-15/16	3/8"	1
64220	2"	3/8"	1
64240	2-1/16	3/8"	1
64250	2-1/8	3/8"	1
64260	2-3/16	3/8"	1
64270	2-1/4	3/8"	1
64280	2-5/16	3/8"	1
64290	2-3/8	3/8"	1
64330	2-7/16	3/8"	1
64340	2-1/2	3/8"	1
64350	2-9/16	3/8"	1
64360	2-5/8	3/8"	1
64370	2-11/16	1/2"	1
64380	2-3/4	1/2"	1
64390	2-13/16	1/2"	1

Part#	Diameter Inches	Shank Diameter	Qty. per/pack
64400	2-7/8	1/2"	1
64410	2-15/16	1/2"	1
64420	3"	1/2"	1
64430	3-1/4	1/2"	1
64440	3-1/2	1/2"	1
64450	3-3/4	1/2"	1
64460	4"	1/2"	1
64470	4-1/4	1/2"	1
64480	4-1/2	1/2"	1
64490	4-3/4	1/2"	1
64231	PILOT DRILL		1
62490	SCREW		1
62530	SPRING		1

Type CHC-QR Carbide Tipped Holecutters

1/4" Quick Release

- 3-flatted shank for keyless chucks.
- Produces overlapping and interrupted holes easily
- Cuts 3 times faster than bi-metal hole saws.

Part#	Diameter Inches	Shank Diameter	Qty. per/pack
83470	5/8	1/4"	1
83480	11/16	1/4"	1
83490	3/4	1/4"	1
83500	13/16	1/4"	1
83510	7/8	1/4"	1
83520	15/16	1/4"	1
83530	1"	1/4"	1
83540	1-1/16	1/4"	1
83550	1-1/8	1/4"	1
83560	1-3/16	1/4"	1
83580	1-1/4	1/4"	1
83590	1-5/16	1/4"	1
83600	1-3/8	1/4"	1
83950	PILOT DRILL		1
83960	SCREW		1
83970	SPRING		1



Quick Release
1/4" Hex Shank

Type EXT

Carbide Tipped Holecutter - Extension

Includes "Allen Wrench" (For CHC-UB & CHD-UB Holecutter only)

Part #	Bore/Shank	Diameter	Overall Length	Ext Length	Qty. per/pack
62710	3/8	7/8	6-1/4"	5 inches	1
62720	1/2	7/8	6-1/4"	5 inches	1

Type CHC-18

CARBIDE TIPPED HOLECUTTER HANGING DISPLAY

Contents	Size	# of Each
CHC-UB	13/16, 7/8, 15/16, 1", 1-1/16	1
Depth of cut	3/16"	1-1/8, 1-3/16, 1-1/4, 1-3/8
CHD-UB	13/16, 7/8, 15/16, 1", 1-1/16	1
Depth of cut	1"	1-1/8, 1-3/16, 1-1/4, 1-3/8
Display Rack	16" width by 27" height	1
(Display Rack Only Part # 14120)		

COUNTERSINKS



Type 82-UB - Piloted



Type 82-UB - Pilotless



Type 90-UB - Deburring

Type 82-UB -Piloted , Type 82-UB -Pilotless , Type 90-UB -Deburring

Type 82-UB Chatterproof™ Countersinks Type 90-UB Chatterproof™ Deburring Tools

Special Hi-Molybdenum tool steel, gold surface treated for maximum lubricity.

These high performance, flute-less tools are:

- Free cutting - for ease of use.
- Designed for fast stock removal.
- Chatter-proof - for a micro smooth finish.
- Easily resharpened - for extra long life.
- Available in a wide selection of styles.
- Recommended for smooth finishes on metal, plastic and wood applications.
- Made in the U.S.A.

TYPE 82-UB 82° PILOTED COUNTERSINK

Part No.	Size	Style	Screw Size	Shank Diameter		Overall Length				No. per/pack
				A	B	C	D	E	F	
67010	CS1/4	1	1/4	1/4	3/8	2	33/64	1	5/32	1
67020	CS1/4A	1	1/4	17/64	3/8	2	33/64	1	5/32	1
67030	CS5/16	1	5/16	5/16	3/8	2-3/16	41/64	1-3/16	5/32	1
67040	CS5/16A	1	5/16	21/64	3/8	2-3/16	41/64	1-3/16	5/32	1
67050	CS3/8	1	3/8	3/8	1/2	2-5/8	49/64	1-3/8	5/32	1
67060	CS3/8A	1	3/8	25/64	1/2	2-5/8	49/64	1-3/8	5/32	1
67070	CS7/16	1	7/16	7/16	1/2	2-3/4	53/64	1-1/2	7/32	1
67080	CS7/16A	1	7/16	29/64	1/2	2-3/4	53/64	1-1/2	7/32	1
67090	CS1/2	1	1/2	1/2	1/2	2-13/16	15/16	1-9/16	1/4	1
67100	CS1/2A	1	1/2	33/64	1/2	2-13/16	15/16	1-9/16	1/4	1

See next page for technical diagram

TYPE 82-UB 82° PILOTLESS COUNTERSINK

Part No.	Size	Style	Diameter of Cut		Screw Size	Shank Diameter		Overall Length			No. per/pack
			Min	Max		B	C	D	E		
67110	CS073	3	0.073	15/64	---	1/4	1-3/4	---	---	1	
67120	CS3/16	2	3/16	17/32	---	1/4	1-15/16	9/16	1	1	
67130	CS307	2	0.307	25/32	---	1/2	2-5/8	13/16	1-3/8	1	
67140	CS307A	2	0.307	25/32	---	1/4	2-1/16	13/16	1-1/4	1	
67150	CS431	2	0.431	7/8	---	1/2	2-13/16	1-1/8	1-9/16	1	
67160	CS1/2B	2	1/2	1-15/32	---	1/2	3-1/2	1-1/2	2-1/8	1	
67170	CS5S	2	---	---	No.4	1/4	1-1/2	17/64	5/8	1	
67180	CS6S	2	---	---	No.6	1/4	1-1/2	19/64	5/8	1	
67190	CS8S	2	---	---	No.8	1/4	1-5/8	11/32	3/4	1	
67200	CS10S	2	---	---	No.10	1/4	1-5/8	25/64	3/4	1	

See next page for technical diagram

TYPE 90-UB 90°DEBURRING TOOLS

Part No.	Size	Style	Diameter of Cut		Shank Diameter B	Overall Length				No. per/pack
			Min	Max		C	D	E		
67210	DB1/64	3	1/64	11/64	3/16	1-1/2	---	---	1	
67220	DB1/16	3	1/16	11/64	3/16	1-1/2	---	---	1	
67230	DB1/8	3	1/8	15/64	1/4	1-3/4	---	---	1	
67240	DB5/32	2	5/32	13/32	1/4	1-11/16	7/16	13/16	1	
67250	DB3/16	2	3/16	17/32	1/4	1-7/8	9/16	1	1	
67260	DB5/16	2	5/16	25/32	1/2	2-19/32	13/16	1-3/8	1	
67270	DB5/16C	2	5/16	25/32	1/4	2-1/32	13/16	1-5/32	1	
67280	DB9/16	2	9/16	1-3/32	1/2	2-13/16	1-1/8	1-9/16	1	
67290	DB1/2	2	1/2	1-15/32	1/2	3-1/2	1-1/2	2-1/8	1	

See next page for technical diagram

COUNTERSINK TECHNICAL DIAGRAM

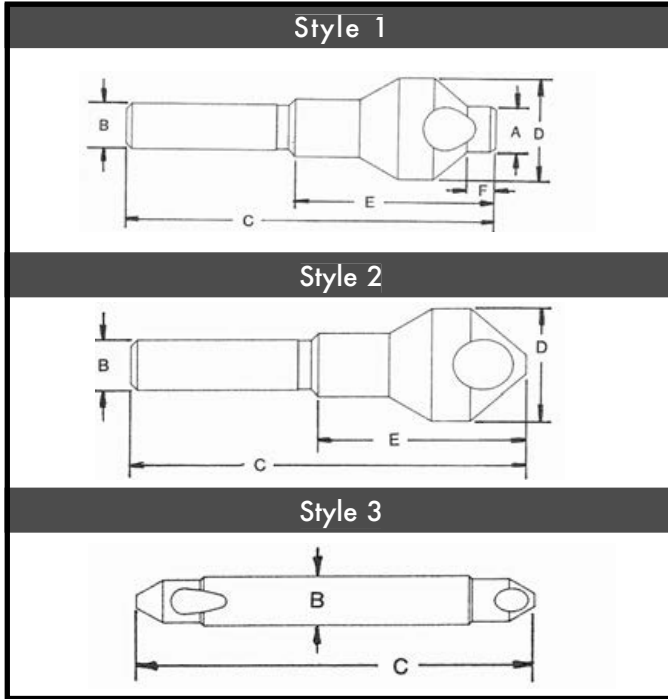

TYPE 82-UB & TYPE 90-UB SETS

Part No.	Description of Sizes
SP-4CS 10440	82-UB C/S sizes: CS5S, CS6S, CS8S, CS10S
SP-4ACS 10442	82-UB C/S sizes: CS6S, CS8S, CS10S, CS3/16
SP-6DB 10450	90-UB D/B sizes: DB1/16, DB1/8, DB5/32, DB3/16, DB5/16 & DB9/16
SP-9CS 10443	82-UB C/S sizes: CS5S, CS6S, CS8S, CS10S, CS1/4, CS5/16, CS3/8, CS7/16, & CS1/2



COMBINED DRILLS & COUNTERSINK

Type 296 -Plain

Type 296

Drill ends are of equal diameter. The included angle is 60°.



TYPE 296 PLAIN COUNTERSINKS

Part No.	Size	Dia. of Body Inches	Dia. & Length of drills	Overall Length Inches	Std. Pack
26760	00	1/8	.025x.030	1-7/32	6
26770	0	1/8	1/32x.038	1-7/32	6
26780	1	1/8	3/64x3/64	1-1/4	6
26790	2	3/16	5/64x5/64	1-7/8	6
26800	3	1/4	7/64x7/64	2	6
26810	4	5/16	1/8x1/8	2-1/8	6
26820	5	7/16	3/16x3/16	2-3/4	6
26830	6	1/2	7/32x7/32	3	6
26840	7	5/8	1/4x1/4	3-1/4	1
26850	8	3/4	5/16x5/16	3-1/2	1

COMBINED DRILL AND COUNTER-SINK - SET

26861 5pcs. Set Sizes: 1, 2, 3, 4 and 5

SUPER COBALT - WELDOUT™ CARBIDE SPOT WELD DRILLS

Type 492-D

Weldout™ Spot weld Super Cobalt High-Speed Steel Gold Finish - Heavy-Duty Spur Point

- This rugged high performance drill is designed to effectively cut auto body panel spot welds.

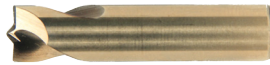

High red hardness of cobalt steel permits speeds 30% greater than high speed steel drill

Part No.	Diameter MM	Approx Spotweld Size, Inches	Overall Length Inches	Flat Length Inches	Qty. per/pack
66420	6.5mm	1/4	1.56	.44	5
37240	6.5mm	1/4	1.49	.44	5
37520	6.5mm	1/4	1.75	none	5
37660	6.5mm TE*	1/4	3.62	none	5
66430	8.0mm	5/16	1.56	.44	5
37250	8.0mm	5/16	1.49	.44	5
37510	8.0mm	5/16	1.69	.75	5
37470	8.0mm	5/16	1.75	none	5
37670	8.0mm TE*	5/16	3.62	none	5
37530	10.0mm	3/8	1.75	none	5
37680	10.0mm TE*	3/8	3.62	none	5

The spur point on the Type 492-D is designed to cut through the weld on one panel while leaving the second panel free of holes.

Type 493-D

Weldout™ Spot weld Super Cobalt High-Speed Steel Gold Finish - Heavy-Duty Spur Point

- This rugged high performance drill is designed to effectively cut auto body panel spot welds.



Part No.	Diameter MM	Approx Spotweld Size, Inches	Overall Length Inches	Flat Length Inches	Qty. per/pack
66180	8.0	5/16	2.25	none	5
66190	10.00	3/8	2.25	none	5
37671	8.0 TE*	5/16	3.62	none	5
37681	10 TE	3/8	3.62	none	5

The modified point on the Type 493-D drill is chip resistant with slightly greater penetration into the second panel.

Weldout™ Spotweld Drills Sets

Selection of the most popular sizes of spot weld drills in an attractive, rugged black steel case.

TYPE 492-D WO-6 SET

Part No.	Description of Sizes
35010	6.5mm, 8.0mm & 10.0mm single-end drills with 1.75" length 6.5mm, 8.0mm & 10.0mm twin end drills with 3.62" length

TYPE 493-D WO-4 SET

Part No.	Description of Sizes
35050	8.0mm & 10mm Single-end 8.0mm & 10mm Twin-end In Type 493-D Length

Type 493-DB

Carbide ALTiN Coated Spot weld Drills

- Designed to cut spot welds from Boron Steel
- Use in high temperature operations and difficult to machine materials. ALTiN coating improves lubricity, eliminating lubrication requirements.

Recommended (900 RPM - 1,000 RPM)



Carbide ALTiN coating improves lubricity.

TYPE 493-DB

Part No.	Diameter MM	Approx Spotweld Size, Inches	Overall Length Inches	Flat Length Inches	Qty. per/pack
85890	8.0	5/16	2.00	NONE	1
85900	10.0	3/8	2.25	NONE	1

TYPE 493-DB WITH FLAT

Part No.	Diameter MM	Approx Spotweld Size, Inches	Overall Length Inches	Flat Length Inches	Qty. per/pack
85880	8.0	5/16	1.75	.750	1

Type 493-DN

Titanium Nitride Weldout™ Spot weld Drills M42 Cobalt High-Speed Steel - Heavy-Duty Spur Point

- Titanium nitride M42 cobalt steel spot weld drills are designed for use in high strength high alloy steel commonly used in the automobile industry.
- Titanium nitride coating doubles the tool life, gives additional lubricity and protects the cutting edges of the drill in tough removal applications.
- Titanium nitride drills require a slower speed (490 RPM) than standard drills (1800 RPM) when drilling difficult materials.

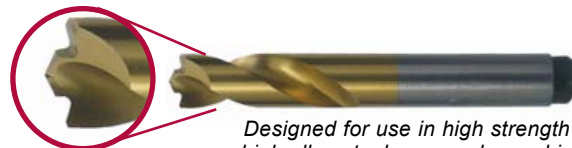

Heavy-Duty Spur Point

Designed for use in high strength high alloy steel commonly used in the automobile industry.

TYPE 493-DN TiN COATED

Part No.	Diameter MM	Approx Spotweld Size, Inches	Overall Length Inches	Flat Length Inches	Qty. per/pack
73450	8.0	5/16	2.25	none	1
73460	10.00	3/8	2.25	none	1
73470	8.0 TE*	5/16	3.62	none	1
73480	10 TE	3/8	3.62	none	1

Premium Carbide Burrs



SA Style

Cylinder Shape - No End Cut 104

SB Style

Cylinder Shape - with End Cut 104

SC Style

Cylinder Shape - Radius End 105

SD Style

Ball Shape 105

SE Style

Oval / Egg Shape 106

SF Style

Tree Shape Radius 106

SG Style

Pointed Tree Shape 107

SH Style

Flame Shape 107

SJ Style

60° Cone Shape 107

SK Style

90° Cone Shape 107

SL Style

Taper Shape Radius -
14° Included Angle 107

SM Style

Pointed Cone Shape 108

SN Style

Inverted Cone Shape 108

Premium Carbide Burrs Sets

Double Cut Sets

Set A - 9 pcs 108

Set B - 9 pcs 108

Set C - 9 pcs 108

Set D - 9 pcs 108

Set E - 8 pcs 108

Set F - 8 pcs 108

Double Cut Display

48 pcs.

Double Cut- 1/8 Shank 108

Double Cut- 1/4 Shank 108

Aluma Cut- 1/4 Shank 108

24 pcs.

Double Cut- 1/4 Shank 108

Double Cut

The most popular burr for ferrous applications.



The flutes are ground in both the left and right hand directions, offering better operator control and rapid stock removal in harder materials.

The double cut geometry reduces the size of the chips and can be used at slower than normal speeds.

Aluma Cut

Designed for used on aluminum, non-ferrous metals, soft steel, reinforced plastics and other soft materials.



The burrs are designed with a high flute finish for easy chip flow and fast stock removal and excellent work piece finish.

MATERIALS	Aluma Cut	Double Cut
Aluminum	✓	
Brass		✓
Bronze		✓
Copper		✓
Cast Iron		✓
Plastics	✓	
Steel (40-50 RC)		✓
Steel (55-60 RC)		✓
Steel (Carbon)		✓
Steel (Nickel Chrome)		✓
Stainless Steel		✓
Steel Weldments		✓
Titanium		✓
Zinc	✓	

Recommended RPM

Diameter	Standard Materials	Stainless Steel	Diameter	Standard Materials	Stainless Steel
1/16	72500	97500	5/16	28000	28000
3/32	65500	89000	3/8	25000	25000
1/8	56000	76000	7/16	22000	22000
5/32	46000	70000	1/2	18800	18800
3/16	40000	65500	5/8	17000	17000
1/4	35000	61000	3/4	14900	14900
			1"	12600	12600

SA CYLINDER SHAPE - NO END CUT

Application: Deburring

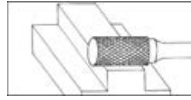

SB CYLINDER SHAPE - WITH END CUT

Application: Peripheral Milling & Face Milling

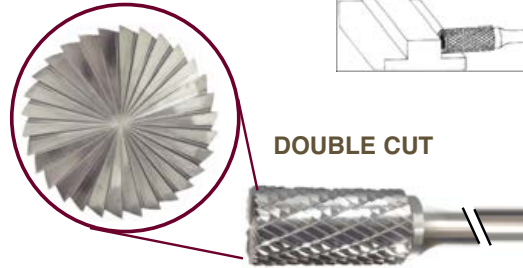
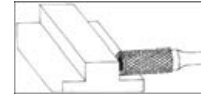

SA / SB - Cylinder Shape - with End Cut & No End Cut

SA - CYLINDER SHAPE - NO END CUT - DOUBLE CUT

Part #	Size	Cut Diameter	Length of Cut	Shank Diameter	Qty.
17079	SA-41	1/16	1/4	1/8	1
17089	SA-42	3/32	7/16	1/8	1
17099	SA-43	1/8	9/16	1/8	1
17109	SA-11	1/8	1/2	1/4	1
17119	SA-12	1/8	5/8	1/4	1
17129	SA-52	5/32	1/2	1/8	1
17139	SA-13	5/32	5/8	1/4	1
17149	SA-14	3/16	5/8	1/4	1
17159	SA-51	1/4	1/2	1/8	1
17169	SA-1	1/4	5/8	1/4	1
17179	SA-1L	1/4	1	1/4	1
17209	SA-2	5/16	3/4	1/4	1
17219	SA-3	3/8	3/4	1/4	1
17229	SA-3L	3/8	1	1/4	1
17249	SA-3X	3/8	1-1/2	1/4	1
17269	SA-4	7/16	1	1/4	1
17279	SA-5	1/2	1	1/4	1
17309	SA-6	5/8	1	1/4	1
17329	SA-15	3/4	1/2	1/4	1
17339	SA-16	3/4	3/4	1/4	1
17349	SA-7	3/4	1	1/4	1
17369	SA-8	7/8	1	1/4	1
17379	SA-9	1	1	1/4	1

SA - CYLINDER SHAPE - NO END CUT - ALUMA

Part #	Size	Cut Diameter	Length of Cut	Shank Diameter	Qty.
17199	SA-1NF	1/4	5/8	1/4	1
17259	SA-3NF	3/8	3/4	1/4	1
17299	SA-5NF	1/2	1	1/4	1
17319	SA-6NF	5/8	1	1/4	1
17359	SA-7NF	3/4	1	1/4	1

SA - CYLINDER SHAPE - NO END CUT 6" EXTENDED SHANK LENGTH

Part #	Size	Cut Diameter	Length of Cut	Shank Diameter	Qty.
17189	SA-1L6	1/4	5/8	1/4	1
17239	SA-3L6	3/8	3/4	1/4	1
17289	SA-5L6	1/2	1	1/4	1

SB - CYLINDER SHAPE - WITH END CUT - DOUBLE CUT

Part #	Size	Cut Diameter	Length of Cut	Shank Diameter	Qty.
17409	SB-41	1/16	1/4	1/8	1
17419	SB-42	3/32	7/16	1/8	1
17429	SB-43	1/8	9/16	1/8	1
17439	SB-11	1/8	1/2	1/4	1
17449	SB-12	1/8	5/8	1/4	1
17459	SB-13	5/32	5/8	1/4	1
17469	SB-14	3/16	5/8	1/4	1
17479	SB-51	1/4	3/16	1/8	1
17489	SB-1	1/4	5/8	1/4	1
17499	SB-1L	1/4	1	1/4	1
17509	SB-2	5/16	3/4	1/4	1
17519	SB-3	3/8	3/4	1/4	1
17529	SB-3L	3/8	1-1/2	1/4	1
17539	SB-3X	3/8	1	1/4	1
17549	SB-4	7/16	1	1/4	1
17559	SB-5	1/2	1	1/4	1
17569	SB-6	5/8	1	1/4	1
17579	SB-15	3/4	1/2	1/4	1
17589	SB-16	3/4	3/4	1/4	1
17599	SB-7	3/4	1	1/4	1
17619	SB-8	7/8	1	1/4	1
17629	SB-9	1	1	1/4	1

SC CYLINDER SHAPE - RADIUS END

Application: Surface Milling & Contouring

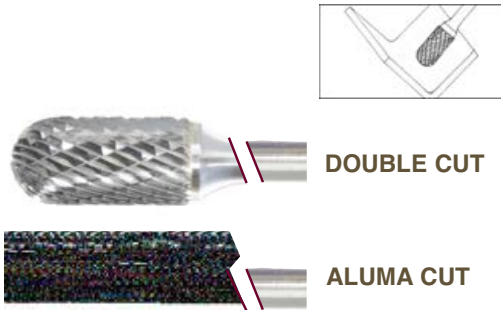

SD BALL SHAPE

Application: Contouring, Hole deburring, Build-up Welding preparation

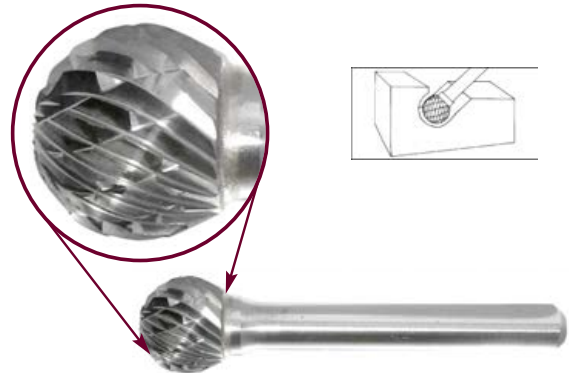

SC - CYLINDER SHAPE - RADIUS END - DOUBLE CUT

Part #	Size	Cut Diameter	Length of Cut	Shank Diameter	Qty.
17659	SC-41	3/32	7/16	1/8	1
17669	SC-42	1/8	9/16	1/8	1
17679	SC-11	1/8	1/2	1/4	1
17689	SC-12	1/8	5/8	1/4	1
17699	SC-52	5/32	1/2	1/8	1
17709	SC-13	5/32	5/8	1/4	1
17719	SC-53	3/16	1/2	1/8	1
17729	SC-14	3/16	5/8	1/4	1
17739	SC-51	1/4	1/2	1/8	1
17749	SC-1	1/4	5/8	1/4	1
17759	SC-1L	1/4	1	1/4	1
17789	SC-2	5/16	3/4	1/4	1
17799	SC-3	3/8	3/4	1/4	1
17809	SC-3L	3/8	1	1/4	1
17829	SC-3X	3/8	1-1/2	1/4	1
17849	SC-4	7/16	1	1/4	1
17859	SC-5	1/2	1	1/4	1
17889	SC-6	5/8	1	1/4	1
17909	SC-15	3/4	1/2	1/4	1
17919	SC-16	3/4	3/4	1/4	1
17929	SC-7	3/4	1	1/4	1
17949	SC-9	1	1	1/4	1

SC - CYLINDER SHAPE - RADIUS END - ALUMA

Part #	Size	Cut Diameter	Length of Cut	Shank Diameter	Qty.
17779	SC-1NF	1/4	5/8	1/4	1
17839	SC-3NF	3/8	3/4	1/4	1
17879	SC-5NF	1/2	1	1/4	1
17899	SC-6NF	5/8	1	1/4	1
17939	SC-7NF	3/4	1	1/4	1

SC-CYLINDER SHAPE - RADIUS END - 6" EXTENDED SHANK LENGTH

Part #	Size	Cut Diameter	Length of Cut	Shank Diameter	Qty.
17769	SC-1L6	1/4	1	1/4	1
17819	SC-3L6	3/8	1	1/4	1
17869	SC-5L6	1/2	1	1/4	1

SD - BALL SHAPE

Part #	Size	Cut Diameter	Length of Cut	Shank Diameter	Qty.
17979	SD-41	3/32	3/32	1/8	1
17989	SD-42	1/8	1/8	1/8	1
17999	SD-11	1/8	1/8	1/4	1
18019	SD-53	3/16	3/16	1/8	1
18029	SD-14	3/16	3/16	1/4	1
18039	SD-51	1/4	1/4	1/8	1
18049	SD-1	1/4	1/4	1/4	1
18079	SD-2	5/16	5/16	1/4	1
18089	SD-3	3/8	3/8	1/4	1
18119	SD-4	7/16	7/16	1/4	1
18129	SD-5	1/2	1/2	1/4	1
18159	SD-6	5/8	5/8	1/4	1
18179	SD-7	3/4	3/4	1/4	1
18199	SD-9	1	1	1/4	1

SD - BALL SHAPE - ALUMA

Part #	Size	Cut Diameter	Length of Cut	Shank Diameter	Qty.
18069	SD-1NF	1/4	1/4	1/4	1
18109	SD-3NF	3/8	3/8	1/4	1
18149	SD-5NF	1/2	1/2	1/4	1
18169	SD-6NF	5/8	5/8	1/4	1
18189	SD-7NF	3/4	3/4	1/4	1

SD - BALL SHAPE - 6" EXTENDED SHANK LENGTH

Part #	Size	Cut Diameter	Length of Cut	Shank Diameter	Qty.
18059	SD-1L6	1/4	7/32	1/4	1
18099	SD-3L6	3/8	5/16	1/4	1
18139	SD-5L6	1/2	7/16	1/4	1

SC - Cylinder Shape - Radius End / SD - Ball Shape

SE - OVAL / EGG SHAPE

Application: Contouring

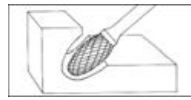

DOUBLE CUT



ALUMA CUT

SE - OVAL/EGG SHAPE

Part #	Size	Cut Diameter	Length of Cut	Shank Diameter	Qty.
18239	SE-41	1/8	7/32	1/8	1
18249	SE-53	3/16	9/32	1/8	1
18259	SE-11	3/16	5/16	1/4	1
18269	SE-51	1/4	3/8	1/8	1
18279	SE-1	1/4	3/8	1/4	1
18299	SE-3	3/8	5/8	1/4	1
18329	SE-5	1/2	7/8	1/4	1
18359	SE-6	5/8	1	1/4	1
18379	SE-7	3/4	1	1/4	1

SE - OVAL/EGG SHAPE - ALUMA

Part #	Size	Cut Diameter	Length of Cut	Shank Diameter	Qty.
18319	SE-3NF	3/8	5/8	1/4	1
18349	SE-5NF	1/2	7/8	1/4	1
18369	SE-6NF	5/8	1	1/4	1
18389	SE-7NF	3/4	1	1/4	1

SE - OVAL/EGG 6" EXTENDED SHANK LENGTH

Part #	Size	Cut Diameter	Length of Cut	Shank Diameter	Qty.
18289	SE-1L6	1/4	3/8	1/4	1
18309	SE-3L6	3/8	19/32	1/4	1
18339	SE-5L6	5/8	7/8	1/4	1

SF - TREE SHAPE RADIUS

Application: Narrow Contours

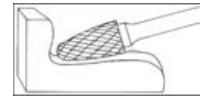

DOUBLE CUT



ALUMA CUT

SF - TREE SHAPE RADIUS

Part #	Size	Cut Diameter	Length of Cut	Shank Diameter	Qty.
18429	SF-41	1/8	1/4	1/8	1
18439	SF-42	1/8	1/2	1/8	1
18449	SF-11	1/8	1/2	1/4	1
18459	SF-53	3/16	1/2	1/8	1
18469	SF-51	1/4	1/2	1/8	1
18479	SF-1	1/4	5/8	1/4	1
18509	SF-3	3/8	3/4	1/4	1
18539	SF-4	7/16	1	1/4	1
18549	SF-13	1/2	3/4	1/4	1
18559	SF-5	1/2	1	1/4	1
18589	SF-6	5/8	1	1/4	1
18609	SF-7	3/4	1	1/4	1
18629	SF-14	3/4	1-1/4	1/4	1
18649	SF-15	3/4	1-1/2	1/4	1

SF - TREE SHAPE RADIUS - ALUMA

Part #	Size	Cut Diameter	Length of Cut	Shank Diameter	Qty.
18499	SF-1NF	1/4	5/8	1/4	1
18529	SF-3NF	3/8	3/4	1/4	1
18579	SF-5NF	1/2	1	1/4	1
18599	SF-6NF	5/8	1	1/4	1
18619	SF-7NF	3/4	1	1/4	1
18639	SF-14NF	3/4	1-1/4	1/4	1

SF - TREE SHAPE RADIUS 6" EXTENDED SHANK LENGTH

Part #	Size	Cut Diameter	Length of Cut	Shank Diameter	Qty.
18489	SF-1L6	1/4	5/8	1/4	1
18519	SF-3L6	3/8	3/4	1/4	1
18569	SF-5L6	1/2	1	1/4	1

SE - Oval/Egg Shape / SF - Tree Shape Radius

Premium Carbide Burrs



SG - POINTED TREE SHAPE

Application: Milling, Acute Angle, Narrow Contouring



SG - POINTED TREE SHAPE

Part #	Size	Cut Diameter	Length of Cut	Shank Diameter	Qty.
18679	SG-41	1/8	1/4	1/8	1
18689	SG-42	1/8	5/16	1/8	1
18699	SG-43	1/8	3/8	1/8	1
18709	SG-44	1/8	1/2	1/8	1
18719	SG-53	3/16	1/2	1/8	1
18729	SG-51	1/4	1/2	1/8	1
18739	SG-1	1/4	5/8	1/4	1
18759	SG-2	5/16	3/4	1/4	1
18769	SG-3	3/8	3/4	1/4	1
18789	SG-13	1/2	3/4	1/4	1
18799	SG-5	1/2	1	1/4	1
18819	SG-6	5/8	1	1/4	1
18829	SG-7	3/4	1	1/4	1
18839	SG-15	3/4	1-1/2	1/4	1

SG - POINTED TREE SHAPE 6" EXTENDED SHANK LENGTH

Part #	Size	Cut Diameter	Length of Cut	Shank Diameter	Qty.
18749	SG-1L6	1/4	5/8	1/4	1
18779	SG-3L6	3/8	3/4	1/4	1
18809	SG-5L6	1/2	1	1/4	1

SJ - 60° CONE SHAPE

Application: Acute Angle Matching



SJ - 60° CONE SHAPE

Part #	Size	Cut Diameter	Length of Cut	Shank Diameter	Qty.
18979	SJ-42	1/8	3/32	1/8	1
18989	SJ-1	1/4	3/16	1/4	1
18999	SJ-3	3/8	5/16	1/4	1
19009	SJ-5	1/2	7/16	1/4	1
19019	SJ-6	5/8	9/16	1/4	1
19029	SJ-7	3/4	11/16	1/4	1
19039	SJ-9	1	15/16	1/4	1

SH - FLAME SHAPE

Contouring & Milling



SH - FLAME SHAPE

Part #	Size	Cut Diameter	Length of Cut	Shank Diameter	Qty.
18869	SH-41	1/8	1/4	1/8	1
18879	SH-53	3/16	3/8	1/8	1
18889	SH-1	1/4	5/8	1/4	1
18899	SH-2	5/16	3/4	1/4	1
18919	SH-5	1/2	1-1/4	1/4	1
18939	SH-6	5/8	1-7/16	1/4	1
18949	SH-7	3/4	1-5/8	1/4	1

SH - FLAME SHAPE 6" EXTENDED SHANK LENGTH

Part #	Size	Cut Diameter	Length of Cut	Shank Diameter	Qty.
18909	SH-2L6	5/16	3/4	1/4	1
18929	SF-5L6	1/2	1-1/4	1/4	1

SK - 90° CONE SHAPE

Application: Acute Angle Machining Chamfering, Countersinking

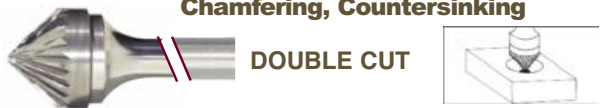

SK - 90° CONE SHAPE

Part #	Size	Cut Diameter	Length of Cut	Shank Diameter	Qty.
19069	SK-42	1/8	1/16	1/8	1
19079	SK-1	1/4	1/8	1/4	1
19089	SK-3	3/8	3/16	1/4	1
19099	SK-5	1/2	1/4	1/4	1
19109	SK-6	5/8	5/16	1/4	1
19119	SK-7	3/4	3/8	1/4	1
19129	SK-9	1	1/2	1/4	1

SL - TAPER SHAPE RADIUS 14° INCLUDED ANGLE

Application: Surface Machining, Narrow Contours and Surfaces



SL - TAPER SHAPE RADIUS 14° INCLUDED ANGLE

Part #	Size	Cut Diameter	Length of Cut	Shank Diameter	Qty.
19159	SL-41	1/8	3/8	1/8	1
19169	SL-42	1/8	1/2	1/8	1
19179	SL-53	3/16	1/2	1/8	1
19189	SL-1	1/4	5/8	1/4	1
19209	SL-2	5/16	7/8	1/4	1
19219	SL-3	3/8	1-1/16	1/4	1
19249	SL-4	1/2	1-1/8	1/4	1
19279	SL-5	5/8	1-3/16	1/4	1
19299	SL-6	5/8	1-5/16	1/4	1
19329	SL-7	3/4	1-1/2	1/4	1

SL - TAPER SHAPE RADIUS 14° INCLUDED ANGLE - ALUMA CUT

19239	SL-3NF	3/8	1-1/16	1/4	1
19269	SL-4NF	1/2	1-1/8	1/4	1
19289	SL-5NF	5/8	1-3/16	1/4	1
19309	SL-6NF	5/8	1-5/16	1/4	1
19329	SL-7NF	3/4	1-1/2	1/4	1

SL - TAPER SHAPE RADIUS 14° INCLUDED ANGLE - EXTRA LENGTH

19199	SL-1L6	1/4	5/8	1/4	1
19229	SL-3L6	3/8	1-1/16	1/4	1
19256	SL-4L6	1/2	1-1/8	1/4	1

SG - Pointed Tree / SH - Flame / SJ - 60° Cone / SK - 90° Cone / SL - Taper Shape Radius

SM - POINTED CONE SHAPE

Application: Surface Machining, Narrow Contours

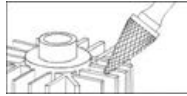

DOUBLE CUT

SM - POINTED CONE SHAPE

Part#	Size	Cut Diameter	Length of Cut	Shank Diameter	Included Angle	Qty.
19359	SM-41	1/8	11/32	1/8	12°	1
19369	SM-42	1/8	7/16	1/8	14°	1
19379	SM-43	1/8	5/8	1/8	7°	1
19389	SM-53	3/16	1/2	1/8	16°	1
19399	SM-51	1/4	1/2	1/8	22°	1
19409	SM-1	1/4	1/2	1/4	22°	1
19419	SM-2	1/4	3/4	1/4	14°	1
19429	SM-3	1/4	1	1/4	10°	1
19439	SM-4	3/8	5/8	1/4	28°	1
19449	SM-5	1/2	7/8	1/4	28°	1
19459	SM-6	5/8	1	1/4	31°	1

SN - INVERTED CONE SHAPE

Application: Edge Milling, Rear Machining on difficult to reach areas

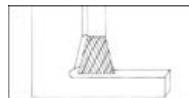

DOUBLE CUT

SN - INVERTED CONE SHAPE

Part #	Size	Cut Diameter	Length of Cut	Shank Diameter	Included Angle	Qty.
19489	SN-41	3/32	1/8	1/8	10°	1
19499	SN-42	1/8	3/16	1/8	10°	1
19509	SN-53	3/16	1/4	1/8	10°	1
19519	SN-51	1/4	1/4	1/8	10°	1
19529	SN-1	1/4	5/16	1/4	10°	1
19539	SN-2	3/8	3/8	1/4	13°	1
19549	SN-4	1/2	1/2	1/4	28°	1
19559	SN-6	5/8	3/4	1/4	18°	1
19569	SN-7	3/4	5/8	1/4	30°	1

PREMIUM CARBIDE DOUBLE CUT BURR SETS

Burrs Set A - 9 pcs. Part #19669
SA-51, SB-51, SC-51, SD-51, SE-51, SF-51, SG-51, SM-51, SN-51

Burrs Set B - 9 pcs. Part #19649
SA-1, SA-3, SA-5, SC-1, SC-3, SC-5, SF-1, SF-3, SF-5

Burrs Set C - 9 pcs. Part #19639
SB-1, SB-3, SB-5, SD-1, SD-3, SD-5, SE-1, SE-3, SE-5

Burrs Set D - 9 pcs. Part #19629
SB-1, SB-3, SB-5, SC-1, SC-3, SC-5SF-1, SF-3, SF-5

Burrs Set E - 8 pcs. Part #19619
SA-5, SC-5, SD-5, SE-5, SG-5, SH-5, SK-5, SM-5

Burrs Set F - 8 pcs. Part #19609
SB-5, SC-5, SD-5, SF-5, SG-5, SH-5, SJ-5, SK-5

PREMIUM CARBIDE DOUBLE & ALUMA CUT BURR DISPLAYS



11 1/2 x 6 1/2 (H) x 12 (W)

Burrs Display - 48 pcs. . . Part #19689

Double Cut: (1/8 SHANK)
SA-51DC, SB-5DC, SC-51DC, SD-51DC, SE-51DC, SF-51DC, SG-51DC, SM-51DC, SN-51DC

Double Cut: (1/4 SHANK)
SA-1DC, SA-3DC, SA-5DC, SC-1DC, SC-3DC, SC-5DC, SD-1DC, SD-3DC, SD-5DC, SE-1DC, SE-3DC, SE-5DC, SF-1DC, SF-3DC, SF-5DC, SG-1DC, SG-3DC, SG-5DC, SL-4DC, SL-3DC, SL-1DC, SM-5DC, SM-4DC, SM-3DC

Aluma Cut: (1/4 SHANK)
SA-1NF, SA-3NF, SA-5NF, SC-1NF, SC-3NF, SC-5NF, SD-5NF, SD-3NF, SE-5NF, SE-3NF, SF-5NF, SF-3NF, SF-1NF, SL-4NF, SL-3NF

24 pcs. Burrs Display

Part #19679

Double Cut: (1/4 SHANK)
SA-5DC, SA-3DC, SA-1DC, SC-5DC, SC-3DC, SC-1DC, SD-5DC, SD-3DC, SD-1DC, SE-5DC, SE-3DC, SE-1DC, SF-5DC, SF-3DC, SF-1DC, SG-5DC, SG-3DC, SG-1DC, SL-4DC, SL-3DC, SL-1DC, SM-5DC, SM-4DC, SM-3DC



9 x 6 1/2 (H) x 9 1/2 (W)

SM - Pointed Cone Shape / SN - Inverted Cone Shape / Sets , Displays

Cutting Tool Sets Index



Jobber Length NAS 907B Heavy Duty 135° Split point

NEW Type 240-CT CN-tech™ Cryo Nitride 110

Type 240-UB 110

Type 643-UB Metric 110

*Type 278-UB 3/8" Shank 110

Type 240-A Black Oxide. 112 - 113

*Type 248-A V-Line Black Oxide. 114

Type 240-AN Titanium Nitride. . . 112 - 113

Type 240-ACN Titanium Carbon Nitride 112 - 113

Type 240-ALN Aluminum Titanium Nitride 112 - 113

*Type 240-GF GoldStrike™ 3-Flats 114

*Type 240-GFR GoldStrike™ 3/8" RS 114

*** Not NAS907B**

Mechanic Length 135° Split point

Type 250-UB 111

Type 258-UB Ultra Bor 3/8" Shank . . 111

Type QR-UB 1/4" Hex Shank. 111

Type 241-A V-line Black Oxide . . . 122

Jobber Length General Purpose 118° point

Type 240-B Bright Finish 117 - 120

Type 278 3/8" RS Bright Finish. . . 117 - 119

Type 240-BN Titanium Nitride Coated 117 - 119

Type 240 Black Oxide 117 - 119

Type 643 Metric - Black Oxide . . 117 - 119

Type 248 V-Line Black Oxide . . . 117 - 118

Jobber Length Parabolic 135° Split point

Type 240-P Black Oxide 121

Type 240-PT Titanium Nitride Coated. . 121

Screw Machine Length NAS 907C

Type 260-UB 120

Type 260-T Black Oxide 123

Type 260-TN Titanium Nitride Coated . 123

*** Not NAS907C**

Screw Machine Length 118° point

Type 260 Bright Finish 122

Type 260-BN Titanium Nitride Coated 122

1/4" Shank 118°

Type 275 120

Jobber Length Cobalt NAS 907J

Type 240-D 135° Split point . . . 115 - 116

Type 240-DN Titanium Nitride Coated 115 - 116

Type 643-D Metric - 135° Split point 116

Screw Machine Length M42 Cobalt

Type 260-D 135° Split point 120

Silver & Deming 1/2" Shank

Type 280-UB 135° Split point 124

Type 280-UBX 118° Split pt 3-Flats . 124

Type 280-D 135° Split pt 3-Flats. . . 124

Type 280-MRO 135° Split point 124

Type 280 118° point - Round Shank. . 124

Step Drills

Type 78-UB Gold Oxide. 127

Type 78-UBN Titanium Nitride 127

Type 78-QR 127

Type 78-QRN Titanium Nitride 127

Type 78-ACN Titanium Carbon Nitride . 127

Acrylic Drills

Type 183-UB Super ChipFree™. 122

NEW **Combination Drill & Tap**

Type 40-UB 126

Type 40-QR 126

Weldout™ Spot-weld Drills

Type 493-D WO-4 125

Type 492-D WO-6 125

Left Hand Spiral

Type 240-AL 125

Brad Point Drills

Type 16-UB 125

Tap & Drills

B-18TD Bright 118° Point. 126

SP-18TD Spiral point 126

SP-18TDM Metric Spiral Point. 126

SP-18TDF Spiral Point Fractional 126

SP-12TD Spiral Point Fractional 126

SF-18TDC Straight Flute Fractional. . . 126

SF18TDF Straight Flute Fractional . . 126

SF-10TD Straight Flute Fractional . . 126

Bolt Extractor

BR-8 Left Hand Drill -Bolt Extractor 127

BR-10 Left Hand Drill - Bolt Extractor. . . . 127

SE-4N Bolt Extractor - Spiral Extractor . . . 127

SE-5N Bolt Extractor -Spiral Extractor . . . 127

BR-8SQ Left Hand - Bolt Extractor 127

SQE-4 Bolt Extractor -Spiral Extractor . . . 127

ChatterProof™ Counter-sink

Type 82-UB Counter sink 127

Type 90-UB Deburring Tool 127

Hole Expansion Tools

Type 50-UB Standard Flute 128

Type 51-UB Fast Spiral 128

Hole Hog™

Type 284-UB 128

Carbide Hole Cutters

Type CHC-UB & CHD-UB. 128

NEW 3pc. Carbide Holecutter CHC-UB . 128



Cutting Tool Sets - INDEX



Cutting Tool Sets

JOBBER LENGTH, METRIC 3/8" REDUCED SHANK

Type 240-CN

CN-TECH™ 135° Split point

- Cryogenic treatment creates a more uniform "grain" structure by transforming retained austenite into martensite.
- Modifies the carbon micro-structure through precipitation of carbides increasing resistance to wear.
- Nitride process diffuses nitrogen into the surface to create a case hardening resulting in superior tool life and exceptional corrosion resistance.

Type 240-UB NAS 907B 135° Split point Black & Gold

- Manufactured to **NAS 907B** aerospace specification
- Body and clearance are gold surface treated for maximum lubricity.
- Recommended for use in work hardening grades of stainless steel & other hard metal drilling applications.

13 Pc.

Part No.	1/16-1/4 by 64ths	Qty of each
44110 SP-13	Super Premium 135° Split point	1
47492 CT-13	 CN-TECH™ Cryo Nitride	1

15 Pc.

Part No.	1/16-1/2 by 32nds	Qty of each
44120 SP-15	Super Premium 135° Split point	1
47472 CT-15	 CN-TECH™ Cryo Nitride	1

15 Pc. Ultra Dex

Part No.	1/16-1/2 by 32nds	Qty of each
47482 CT-15P	 CN-TECH™ Cryo Nitride	1

21 Pc.

Part No.	1/16-3/8 by 64ths	Qty of each
44130 SP-21	Super Premium 135° Split point	1

26 Pc.

Part No.	A - Z	Qty of each
88660 SP-26	Super Premium 135° Split point	1

29 Pc.

Part No.	1/16-1/2 by 64ths	Qty of each
44150 SP-29	Super Premium 135° Split point	1
47452 CT-29	 CN-TECH™ Cryo Nitride	1

29 Pc. Ultra Dex

Part No.	1/16-1/2 by 64ths	Qty of each
44170 SP-29P	Super Premium 135° Split point	1
47462 CT-29P	 CN-TECH™ Cryo Nitride	1

29 Pc. Blaze Orange - Ultra Dex

Part No.	1/16-1/2 by 64ths	Qty of each
44210 SP-29PO	Super Premium 135° Split point	1

60 Pc.

Part No.	# 1 - 60	Qty of each
88640 SP-60	Super Premium 135° Split point	1

115 Pc.

Part No.	1/16-1/2 x 64ths + A-Z & 1-60	Qty of each
93840 SP-115	Super Premium 135° Split point	1

Type 278-UB

135° Split point 3/8" Reduced Shank Black & Gold - Ultra Bor Super Premium

- Recommended for use in work hardening grades of stainless steel & other hard metal drilling applications.

21 Pc.

Part No.	Description of Sizes	Qty of each
92170 SP-21R	1/16-1/4 by 64ths, 9/32-1/2 by 32nds	1

15 Pc.

Part No.	Description of Sizes	Qty of each
92110 RSP-15	1/16-1/2 by 32nds	1

29 Pc.

Part No.	Description of Sizes	Qty of each
92100 RSP-29	1/16-1/2 by 64ths	1

29 Pc. - Ultra Dex

Part No.	Description of Sizes	Qty of each
92150 RSP-29P	1/16-1/2 by 64ths	1

Type 643-UB - Metric

NAS 907B Black & Gold Ultra Bor Super Premium, 135° Split point

- Manufactured to **NAS 907B** aerospace specification
- Recommended for use in work hardening grades of stainless steel & other hard metal drilling applications.

11 Pc. - Metric

Part #	1.0mm - 6.0mm x .5mm	Qty of each
58650 SP-11M	Black & Gold Super Premium	1

13 Pc. - Metric

Part #	1.0mm - 7.0mm x .5mm	Qty of each
49042 SP-13M	Black & Gold Super Premium	1

19 Pc. - Metric

Part #	1.0mm - 10.0mm x .5mm	Qty of each
58920 SP-19M	Black & Gold Super Premium	1

25 Pc. - Metric

Part #	1.0mm - 13.0mm x .5mm	Qty of each
58660 SP-25M	Black & Gold Super Premium	1

41 Pc. - Metric

Part #	6.0mm - 10.0mm x .1mm	Qty of each
49043 SP-41M	Black & Gold Super Premium	1

118 Pc. - Metric

Part #	Qty of each
60090 SP-118M	Black & Gold Super Premium
	(1 - 2.45mm by 0.05mm, 2 - 5 10mm by 0.1mm & 10.2, 10.5, 10.8, 11, 11.2, 11.5, 11.8, 12, 12.2, 12.5, 12.8 & 13)

Cutting Tool Sets - Mechanic Length

QUICK RELEASE 1/4" HEX SHANK & 3/8" REDUCED SHANK

Type 250-UB

Mechanic Length - 135° Split point
Black & Gold Ultra Bor Super Premium
3-flats on Shank 3/16" and Larger

- Body and clearance are gold surface treated for maximum lubricity.
- Especially designed for hand held drills.
- Recommended for use in work hardening grades of stainless steel & other hard metal drilling applications.

13 Pc.

Part No.	Description of Sizes	Qty of each
66460 SPM-13	1/16-1/4 by 64ths	1

15 Pc.

Part No.	Description of Sizes	Qty of each
66470 SPM-15	1/16-1/2 by 32nds	1

21 Pc.

Part No.	Description of Sizes	Qty of each
57810 SPM-21	1/16-3/8 by 64ths	1

29 Pc.

Part No.	Description of Sizes	Qty of each
66480 SPM-29	1/16-1/2 by 64ths	1

29 Pc. Black-- Ultra Dex

Part No.	Description of Sizes	Qty of each
66820 SPM-29P	1/16-1/2 by 64ths	1

NEW 29 Pc. Blaze Orange- Ultra Dex

Part No.	Description of Sizes	Qty of each
67650 SPM-29PO	1/16-1/2 by 64ths	1

Type 258-UB

Mechanics Length 135° Split point 3/8" Reduced Shank Black & Gold - Ultra Bor Super Premium

21 Pc.

Part No.	Description of Sizes	Qty of each
92340 RSPM-21R	1/16-1/4 by 64ths + 9/32-1/2 by 32nds (3/8" shank)	1

15 Pc.

Part No.	Description of Sizes	Qty of each
57910 RSPM-15	1/16-1/2 by 32nds (3/8" shank)	1

29 Pc.

Part No.	Description of Sizes	Qty of each
57920 RSPM-29	1/16-1/2 by 64ths (3/8" shank)	1

29 Pc. Black- Ultra Dex

Part No.	Description of Sizes	Qty of each
57950 RSPM-29P	1/16-1/2 by 64ths (3/8" shank) - w/ Ultra Dex	1

NEW 29 Pc. Blaze Orange- Ultra Dex

Part No.	Description of Sizes	Qty of each
58150 RSPM-29PO	1/16-1/2 by 64ths (3/8" shank) - w/ Ultra Dex	1

TYPE QR-UB 1/4" QUICK RELEASE

Quick Release Drills - 135° Split point
Mechanic Length -
Magnum Super Premium

- 135° Split point - Magnum Super Premium with 1/4" Hex Shanks
- Perfect for use with impactor tools.



TYPE QR12-UB HARD CASE SET

Part No.	Description of Sizes	Qty of each
34811	1/16, 3/32, 1/8, 5/32, 3/16, 7/32, 1/4, 5/16, 3/8, 7/16, 1/2 & Quick Release Adapter	1



TYPE QR16-UB SOFT POUCH SET

Part No.	Description of Sizes	Qty of each
34812	1/16, 3/32, 1/8, 5/32, 3/16, 7/32, 1/4, 9/32, 5/16, 11/32, 3/8, 13/32, 7/16, 15/32, 1/2" & Quick Release Adapter	1

TYPE QR7A-UB SOFT POUCH SET

Part No.	Description of Sizes	Qty of each
34804	1/8, 3/16, 1/4, 5/16, 3/8, 7/16, 1/2"	1

Sets QR-7A and QR-7B
do not include Quick Release Adapters.

TYPE QR7B-UB SOFT POUCH SET

Part No.	Description of Sizes	Qty of each
34803	1/16, 3/32, 1/8, 5/32, 3/16, 7/32, 1/4"	1



NAS 907B TiN / TiCN / TiAlN Coated & BLACK OXIDE

Cutting Tool Sets - NAS 907B TiN / TiCN / TiAlN Coated & Black Oxide



A-13



A-15



ACN-15

Type 240-A Black Oxide NAS 907B Heavy-Duty

- The 135° Split point makes this drill self-centering and requires less thrust in drilling harder metal than a general purpose drill.
- Recommended for medium hardness drilling applications.

Type 240-AN Titanium Nitride

NAS 907B 135° Split point Heavy-Duty

- Titanium nitride coating provides a super hard surface with high lubricity.
- Greatly extends tool life in high wear or very abrasive applications.

Type 240-ACN Titanium Carbon Nitride

NAS 907B - 135° Split point HSS Heavy-Duty

- TiCN is harder and has a lower coefficient of friction than Titanium Nitride coating recommended where moderate temperatures are generated.
- Heavy-duty construction for drilling in tougher materials.
- Manufactured from premium high-speed steel.
- 135° Split point is self-centering for reducing thrust and easier penetration.
- Provides exceptional oxidation resistance and extreme hardness.
- Manufactured to **NAS 907B** aerospace specification.

Type 240-ALN Titanium Aluminum Nitride

NAS 907B - 135° Split point HSS Heavy-Duty

- TiAlN provides extreme hardness and oxidation resistance, superior hot hardness when compared to other coating.
- Heavy-duty construction for drilling in tougher materials.
- Manufactured from premium high-speed steel.
- 135° Split point is self-centering for reducing thrust and easier penetration.
- Provides exceptional oxidation resistance and extreme hardness.
- Manufactured to **NAS 907B** aerospace specification.

10 Pc.

1/16 - 5/32 by 64ths + 3/16, 7/32, 1/4"

Part #			Qty of each
43330	A-10	Black Oxide - 135° Split point	1

11 Pc.

1/16 - 3/8 by 32nds Qty of each

43320	A-11	Black Oxide - 135° Split point	1
-------	------	--------------------------------	---

13 Pc.

1/16 - 1/4 by 64ths Qty of each

43340	A-13	Black Oxide - 135° Split point	1
88670	AN-13	Titanium Nitride - 135° Split point	1

15 Pc.

1/16 - 1/2 by 32nds Qty of each

43350	A-15	Black Oxide 135° Split point	1
88680	AN-15	Titanium Nitride 135° Split point	1
81182	ACN-15	Titanium Carbon Nitride 135° SP	1
81150	ALN-15	Titanium Aluminum Nitride 135° SP	1

21 Pc.

1/16 - 3/8 by 64ths Qty of each

43360	A-21	Black Oxide - 135° Split point	1
96740	AN-21	Titanium Nitride 135° Split point	1
81152	ACN-21	Titanium Carbon Nitride 135° SP	1
81160	ALN-21	Titanium Aluminum Nitride 135° SP	1

NAS 907B TiN / TiCN / TiAlN COATED & BLACK OXIDE

Type 240-A Black Oxide

Heavy-Duty NAS 907B

- The 135° Split point makes this drill self-centering and requires less thrust in drilling harder metal than a general purpose drill.
- It is recommended for medium hardness drilling applications.

Type 240-AN Titanium Nitride

NAS 907B 135° Split point Heavy-Duty

- Titanium nitride provides a super hard surface with high lubricity.
- Greatly extends tool life in high wear or very abrasive applications.

Type 240-ACN Titanium Carbon Nitride

NAS 907B - 135° Split point HSS Heavy-Duty

- Heavy-duty construction for drilling in tougher materials
- Manufactured from premium high-speed steel
- 135° Split point is self-centering for reducing thrust and easier penetration
- Provides exceptional oxidation resistance and extreme hardness
- Manufactured to **NAS 907B** aerospace specification.

Type 240-ALN Titanium Aluminum Nitride

NAS 907B - 135° Split point HSS Heavy-Duty

- Heavy-duty construction for drilling in tougher materials
- Manufactured from premium high-speed steel
- 135° Split point is self-centering for reducing thrust and easier penetration
- Provides exceptional oxidation resistance and extreme hardness
- Manufactured to **NAS 907B** aerospace specification.



AN-29



AN-29PO

26 Pc.

Part #	A - Z	Qty of each
43370	A-26	Black Oxide - 135° Split point 1

29 Pc.

Part #	1/16 - 1/2 by 64ths	Qty of each
43380	A-29	Black Oxide - 135° Split point 1
96690	AN-29	Titanium Nitride - 135° Split point 1
81162	ACN-29	Titanium Carbon Nitride 135° Split point 1
81180	ALN-29	Titanium Aluminum Nitride 135° Split point 1

29 Pc. Blaze Orange - Ultra Dex

Part No.	1/16 - 1/2 by 64ths	Qty of each
96750	AN-29PO	Titanium Nitride - 135° Split point 1

60 Pc.

Part #	# 1 - 60	Qty of each
43390	A-60	Black Oxide - 135° Split point 1
96700	AN-60	Titanium Nitride - 135° Split point 1

115 Pc.

Part #	1/16 - 1/2 by 64ths + A - Z, #1 - 60	Qty of each
43420	A-115	Black Oxide - 135° Split point 1
95110	AN-115	Titanium Nitride - 135° Split point 1



A-60

Cutting Tool Sets - NAS 907B TiN / TiCN / TiAlN Coated & Black Oxide TiCN / TiAlN

NAS 907B BLACK OXIDE & 3/8" REDUCED SHANK - JOBBER LENGTH



SA-21

Type 248-A V-Line Heavy-Duty Black Oxide

- American made value line drill.
- These 135° Split point drills are self centering and perform well in hard metals.
- This series is designed for the user whose applications are well served without the need for the tighter tolerances of our standard Type 240-A.

Type 240-GF Gold-Strike™ 3-Flats on Shank 3/16" and Larger

- Heavy-duty 135° Split point drills perform well in very demanding applications.
- Ideal for use with hand held drills with keyless chucks.

Type 240-GFR 3/8" Reduced Shank with Flats

- Heavy-duty gold finish 135° Split point drills perform well in very demanding applications.
- The flats on shank give positive chuck grip, ideal for use with hand held drills with key-less chucks.



GF-21RS

13 Pc.

Part #	1/16 - 1/4 by 64ths	Qty of each
06072 SA-13	Black Oxide - 135° Split point	1
40611 GF-13	Gold Strike™ - 135° Split point	1

15 Pcs.

Part #	1/16 - 1/2 by 32nds	Qty of each
06082 SA-15	Black Oxide - 135° Split point	1
40612 GF-15	Gold Strike™ - 135° Split point	1

21 Pc.

Part #	1/16 - 3/8 by 64ths	Qty of each
06092 SA-21	Black Oxide - 135° Split point	1
40613 GF-21	Gold Strike™ - 135° Split point	1
40631 GF-21RS	3/8" - RS Gold Strike™ (1/16 - 1/4 by 64ths & 9/32 - 1/2 by 32nds 3/8" shank)	1

29 Pc.

Part #	1/16 - 1/2 by 64ths	Qty of each
06102 SA-29	Black Oxide - 135° Split point	1
40604 GF-29	Gold Strike™ - 135° Split point	1
40641 GF-29RS	3/8" - RS Gold Strike™ (1/16 - 1/4 by 64ths & 9/32 - 1/2 by 32nds 3/8" shank)	1

29 Pc. -Ultra Dex

Part #	1/16 - 1/2 by 64ths	Qty of each
40614 GF-29P	Gold Strike™ - 135° Split point	1
40651 GF-29RSP	3/8" - RS Gold Strike™ (1/16 - 1/4 by 64ths & 9/32 - 1/2 by 32nds 3/8" shank)	1



GF-29P

COBALT HEAVY DUTY 135° SPLIT POINT - JOBBER LENGTH

Type 240-D M42 Cobalt NAS 907J

- Manufactured from M42 HSS containing 8% cobalt which increases high red hardness.
- Cobalt drills require rigidly held positive feed drilling equipment.
- Manufactured to **NAS 907J** specifications.

Type 240-DN M42 Cobalt NAS 907J - Titanium Nitride

- Manufactured from M42 HSS containing 8% cobalt which increases high red hardness.
- Cobalt drills require rigidly held positive feed drilling equipment.
- Titanium Nitride extends tool life.
- Manufactured to **NAS 907J** specifications.

Type 643-D M42 Cobalt NAS 907J - Metric

- Manufactured from M42 HSS containing 8% cobalt which increases high red hardness.
- Cobalt drills require rigidly held positive feed drilling equipment.
- Manufactured to **NAS 907J** specifications.

13 Pc.

Part #	1/16 - 1/4 by 64ths	Qty of each
68320 D-13	M42 Cobalt NAS 907J	1
67989 DN-13	M42 Cobalt NAS 907J Titanium Nitride	1

15 Pc.

Part #	1/16 - 1/2 by 32nds	Qty of each
68340 D-15	M42 Cobalt NAS 907J	1
79900 DN-15	M42 Cobalt NAS 907J Titanium Nitride	1

21 Pc.

Part #	1/16-3/8 by 64ths	Qty of each
68360 D-21	M42 Cobalt NAS 907J	1
79910 DN-21	M42 Cobalt NAS 907J Titanium Nitride	1

26 Pc.

Part #	A - Z	Qty of each
68380 D-26	M42 Cobalt NAS 907J	1
79930 DN-26	M42 Cobalt NAS 907J Titanium Nitride	1

29 Pc.

Part #	1/16-1/2 by 64ths	Qty of each
68400 D-29	M42 Cobalt NAS 907J	1
79920 DN-29	M42 Cobalt NAS 907J Titanium Nitride	1

29 Pc. -Ultra Dex

Part #	1/16-1/2 by 64ths	Qty of each
68410 D-29P	M42 Cobalt NAS 907J	1



D-29

METRIC

Cutting Tool Sets - Cobalt Heavy Duty 135° Split point

COBALT HEAVY DUTY 135° SPLIT POINT - JOBBER LENGTH

Type 240-D M42 Cobalt NAS 907J

- Manufactured from M42 HSS containing 8% cobalt which increases high red hardness.
- Cobalt drills require rigidly held positive feed drilling equipment.
- Manufactured to **NAS 907J** specifications.

Type 240-DN M42 Cobalt NAS 907J - Titanium Nitride

- Manufactured from M42 HSS containing 8% cobalt which increases high red hardness.
- Cobalt drills require rigidly held positive feed drilling equipment.
- Manufactured to **NAS 907J** specifications.

Type 643-D M42 Cobalt NAS 907J - Metric

- Manufactured from M42 HSS containing 8% cobalt which increases high red hardness.
- Cobalt drills require rigidly held positive feed drilling equipment.
- Manufactured to **NAS 907J** specifications.

METRIC

Cutting Tool Sets - Cobalt Heavy Duty 135° Split point / TIN Coated



D-115

60 Pc.		
Part #	#1 - 60	Qty of each
68420	D-60 M42 Cobalt NAS 907J	1
79940	DN-60 M42 Cobalt NAS 907J Titanium Nitride	1

115 Pc.		
Part #	1/16 - 1/2 by 64ths + A - Z , #1 - 60	Qty of each
69280	D-115 M42 Cobalt NAS 907J	1
79950	DN-115 M42 Cobalt NAS 907J Titanium Nitride	1



D-25M

11 Pc. - Metric		
Part #	1.0mm - 6.0mm x .5mm	Qty of each
58670	D-11M M42 Cobalt NAS 907J Gold Finish	1

13 Pc.- Metric		
Part #	1.0mm - 7.0mm x .5mm	Qty of each
49082	D-13M M42 Cobalt NAS 907J Gold Finish	1

19 Pc. - Metric		
Part #	1.0mm - 10.0mm x .5mm	Qty of each
49081	D-19M M42 Cobalt NAS 907J Gold Finish	1

25 Pc. - Metric		
Part #	1.0mm - 13.0mm x .5mm	Qty of each
58680	D-25M M42 Cobalt NAS 907J Gold Finish	1

41 Pcs. - Metric		
Part #	6.0mm - 10.0mm x .1mm	Qty of each
49083	D-41M M42 Cobalt NAS 907J Gold Finish	1

GENERAL PURPOSE 118° POINT - JOBBER LENGTH

Type 240 Black Oxide

- Widely used in general purpose applications.
- Designed for a wide range of operating conditions and materials.

Type 240-B Bright Finish

- Widely used in general purpose applications.
- Designed for a wide range of operating conditions and materials.

Type 240-BN TiN Coated

- Titanium Nitride extends cutting tool life.
- Widely used in general purpose applications.
- Designed for a wide range of operating conditions and materials.

Type 278 Bright Finish, 3/8" Reduced Shank

- General purpose 118° point HSS drill is designed for use in portable air or electric drilling equipment with 3/8" chucks.

Type 248 V-Line, Black Oxide

- American made value line drill
- These general purpose 118° point HSS drills are ideal for a wide variety of light tensile strength metal drilling applications.
- This series is designed for the user whose applications are well served without the need for the tighter tolerances of our standard **Type 240**.



B-13



B-21



BN-15

10 Pc.

1/16 - 5/32" by 64ths + 3/16, 7/32, 1/4"

Part #			Qty of each
42000	B-10	Black Oxide - 118° Point	1
43400	J-10	Bright Finish - 118° Point	1

11 Pc.

1/16 - 3/8" by 32nds

Part #			Qty of each
42010	B-11	Black Oxide - 118° Point	1
43410	J-11	Bright Finish - 118° Point	1

13 Pc.

1/16 - 1/4" by 64ths

Part #			Qty of each
42020	B-13	Black Oxide - 118° Point	1
43430	J-13	Bright Finish - 118° Point	1
48310	BN-13	Titanium Nitride - 118° Point	1
06073	SJ-13	V-Line Black Oxide - 118° Point	1

15 Pc.

1/16 - 1/2" by 32nds

Part #			Qty of each
42030	B-15	Black Oxide - 118° Point	1
43450	J-15	Bright Finish - 118° Point	1
48320	BN-15	Titanium Nitride - 118° Point	1
44540	R-15	3/8" Reduced Shank Bright Finish	1
06083	SJ-15	V-Line Black Oxide - 118° Point	1

Continued on page 118

Cutting Tool Sets - Bright / TiN Coated / Black Oxide

GENERAL PURPOSE 118° POINT - JOBBER LENGTH

Type 240 Black Oxide

- Widely used in general purpose applications.
- Designed for a wide range of operating conditions and materials.

Type 240-B Bright Finish

- Widely used in general purpose applications.
- Designed for a wide range of operating conditions and materials.

Type 240-BN Titanium Nitride

- Titanium Nitride extends cutting tool life.
- Widely used in general purpose applications.
- Designed for a wide range of operating conditions and materials.

Type 278 Bright Finish, 3/8" Reduced Shank

- General purpose 118° point HSS drill is designed for use in portable air or electric drilling equipment with 3/8" chucks.

Type 248 V-Line, Black Oxide

- American made value line drill
- These general purpose 118° point HSS drills are ideal for a wide variety of light tensile strength metal drilling applications.
- This series is designed for the user whose applications are well served without the need for the tighter tolerances of our **standard Type 240**.



J-29



SJ-29

20 Pc.

Part #	# 61 - 80	Qty of each
42040	B-20 Black Oxide - 118° Point	1
43460	J-20 Bright Finish - 118° Point	1
48360	BN-20 Titanium Nitride - 118° Point	1

21 Pc.

Part #	1/16 - 3/8" by 64ths	Qty of each
42050	B-21 Black Oxide - 118° Point	1
43480	J-21 Bright Finish - 118° Point	1
06093	SJ-21 V-Line Black Oxide - 118° Point	1

26 Pc.

Part #	A - Z	Qty of each
42060	B-26 Black Oxide - 118° Point	1
48640	BN-26 Titanium Nitride - 118° Point	1
43500	J-26 Bright Finish - 118° Point	1

29 Pc.

Part #	1/16 - 1/2" by 64ths	Qty of each
42070	B-29 Black Oxide - 118° Point	1
43520	J-29 Bright Finish - 118° Point	1
48330	BN-29 Titanium Nitride - 118° Point	1
44530	R-29 3/8" Reduced Shank Bright Finish	1
06103	SJ-29 V-Line Black Oxide - 118° Point	1

60 Pc.

Part #	# 1 - 60	Qty of each
42080	B-60 Black Oxide - 118° Point	1
43540	J-60 Bright Finish - 118° Point	1
48340	BN-60 Titanium Nitride - 118° Point	1

GENERAL PURPOSE 118° POINT - JOBBER LENGTH

Type 240 Black Oxide

- Widely used in general purpose applications.
- Designed for a wide range of operating conditions and materials.

Type 240-B Bright Finish

- Widely used in general purpose applications.
- Designed for a wide range of operating conditions and materials.

Type 240-BN Titanium Nitride

- Titanium Nitride extends cutting tool life.
- Widely used in general purpose applications.
- Designed for a wide range of operating conditions and materials.

Type 278 Bright Finish 3/8" Reduced Shank

- General purpose 118° point HSS drill is designed for use in portable air or electric drilling equipment with 3/8" chucks.

Type 643 Black Oxide - METRIC

- Widely used in general purpose applications.
- Designed for a wide range of operating conditions and materials.

80 Pc.		
Part #	#1 - 80	Qty of each
43300 B-80	Black Oxide - 118° Point	1

114 Pc.		
1/16 - 1/2 by 64ths, #1 - 60, 1.0mm - 13.0mm by .5mm		
Part #		Qty of each
43310 B-114	Black Oxide - 118° Point	1

115 Pc.		
1/16 - 1/2 by 64ths + A - Z, #1-60		
Part #		Qty of each
43440 B-115	Black Oxide - 118° Point	1
43550 J-115	Bright Finish - 118° Point	1
48350 BN-115	Titanium Nitride - 118° Point	1
44520 R-115	3/8" Reduced Shank Bright Finish	1

11 Pc. - Metric		
Part #	1.0mm - 6.00 by .5mm	Qty of each
44050 M-11	Black Oxide - 118° Point	1

13 Pc.- Metric		
Part #	1.0mm - 7.0mm x .5mm	Qty of each
44180 M-13	Black Oxide - 118° Point	1

25 Pcs. - Metric		
Part #	1.0mm - 13.0mm by .5mm	Qty of each
44060 M-25	Black Oxide - 118° Point	1



R-29



M-11

METRIC

Cutting Tool Sets - Bright / TIN Coated / Black Oxide

BRIGHT 1/4" SHANK & M42 COBALT - SCREW MACHINE LENGTH

Type 240-B Bright Finish

- Widely used in general purpose applications.
- Designed for a wide range of operating conditions and materials.

PL-13



7 Pc.

1/16, 3/32, 1/8, 5/32, 3/16, 7/32, 1/4"

Part #	Description	Qty of each
44267 PL-7	Bright Finish - 118° Point	1

10 Pc.

1/16 - 5/32 by 64ths + 3/16, 7/32, 1/4"

Part #	Description	Qty of each
44277 PL-10	Bright Finish - 118° Point	1

13 Pc.

1/16 - 1/4" by 64ths

Part #	Description	Qty of each
44287 PL-13	Bright Finish - 118° Point	1

Type 275

1/4" Shank - General Purpose 118° Point

- For use in portable air and electric equipment with 1/4" chucks, the shorter-than-jobber length greatly increases rigidity and improves performance.

Q-29



15 Pc.

1/16 - 1/2" by 32nds

Part #	Description	Qty of each
43580 Q-15	Black Oxide Flutes - 118° Point	1

21 Pc.

1/16 - 1/2" by 32nds

Part #	Description	Qty of each
43600 Q-21	Black Oxide Flutes - 118° Point	1

29 Pc.

1/16 - 1/2" by 64ths

Part #	Description	Qty of each
43620 Q-29	Black Oxide Flutes - 118° Point	1

Type 260-D

M42 Cobalt Screw Machine High-Speed Steel Heavy-Duty - Gold Finish

- Use to drill hard, tough metals, free machining stainless steel, titanium alloys and certain abrasive plastics.
- High red hardness of cobalt permits speed 30% over regular high-speed drills



DT-29

13 Pc.

1/16 - 1/4" by 64ths

Part No.	Description	Qty of each
42610 DT-13	M42 Cobalt NAS 907C	1

15 Pc.

1/16 - 1/2" by 32nds

Part No.	Description	Qty of each
42620 DT-15	M42 Cobalt NAS 907C	1

21 Pc.

1/16 - 3/8" by 64ths

Part No.	Description	Qty of each
42640 DT-21	M42 Cobalt NAS 907C	1

29 Pc.

1/16 - 1/2" by 64ths

Part No.	Description	Qty of each
42630 DT-29	M42 Cobalt NAS 907C	1

Type 260-UB

Screw Machine Length, Super Premium Black & Gold, 135° Split point

- Special Hi-Molybdenum surface treated body and clearance for maximum lubricity.
- Recommended for work hardening grades of stainless steel and other hard metal drilling applications.

26 Pc.

Part No.	Description of Sizes	Qty of each
66850 SPT-26	A-Z	1

29 Pc.

Part No.	Description of Sizes	Qty of each
66490 SPT-29	1/16-1/2 by 64ths	1

60 Pc.

Part No.	Description of Sizes	Qty of each
23560 SPT-60	#1-60	1

PARABOLIC TITANIUM NITRIDE & SURFACE TREATED

Type 240-P

Parabolic Flute 135° Split point, Black Oxide

- Parabolic flute drills are designed to allow deep hole drilling without frequent drill removal to clear chips.
- Drills perform best in low to medium tensile strength materials.

Type 240-PT

Parabolic Flute Titanium Nitride - 135° Split point

- Exceptional high-performance drill with the Titanium coating may extend tool life 500% or more in very abrasive drilling applications.
- The parabolic flutes eliminate the need for frequent drill removal in deep hole drilling.

13 Pc.

Part #	1/16 - 1/4" by 64ths	Qty of each
68080 P-13	Black Oxide -135° Split point	1
68090 PT-13	Titanium Nitride -135° Split point	1

15 Pc.

Part #	1/16 - 1/2" by 32nds	Qty of each
68100 P-15	Black Oxide -135° Split point	1
68110 PT-15	Titanium Nitride -135° Split point	1

21 Pc.

Part #	1/16 - 3/8" by 64ths	Qty of each
68120 P-21	Black Oxide -135° Split point	1
68130 PT-21	Titanium Nitride -135° Split point	1

29 Pc.

Part #	1/16 - 1/2" by 64ths	Qty of each
68150 P-29	Black Oxide -135° Split point	1
68160 PT-29	Titanium Nitride -135° Split point	1



P-21



PT-29

Cutting Tool Sets - Parabolic Titanium Coated & Black Oxide



Cutting Tool Sets

CAD-HD, SCREW MACHINE AND ACRYLIC DRILLS



CAD-15A



AD-7

Type 260

118° Point Screw Machine Length
High-Speed Steel - General Purpose,

- The short length of drill and flute makes this an especially rigid drill for greater drilling accuracy.
- This drill is designed for ease of penetration and to facilitate chip removal in tough, hard materials.

Type 260-BN

118° Point Screw Machine Length - Titanium
Nitride High-Speed Steel

- The short length of drill and flute makes this an especially rigid drill for greater drilling accuracy.
- Can be used for all screw machine operation.
- This drill is designed for ease of penetration and to facilitate chip removal in tough, hard materials

Type 241-A CAD-HD - Mechanic Length

V-Line Heavy-Duty Black Oxide - 135° Split point

- American made value line drill
- Black oxide prevents chip welding and increases abrasion resistance.

13 Pc.

Part #	1/16 - 1/4" by 64ths	Qty of each
43342 CAD-13A	Black Oxide - 135° Split point	1

15 Pc.

Part #	1/16 - 1/2" by 32nds	Qty of each
43352 CAD-15A	Black Oxide - 135° Split point	1

21 Pc.

Part #	1/16 - 3/8" by 64ths	Qty of each
43362 CAD-21A	Black Oxide - 135° Split point	1

29 Pc.

Part #	1/16 - 1/2" by 64ths	Qty of each
43382 CAD-29A	Black Oxide - 135° Split point	1

Type 183-UB

Super Premium Acrylic Drills

- Super CHIPFREE™ point is precision ground at a 60° angle for gradual penetration to avoid cracking and chipping of the acrylic material.
- Special 0° rake angle on cutting edge eliminates "grabbing" when drill breaks through plastic, acrylic, or laminate surfaces.
- All sizes over 1/4" have 1/4" shanks.

7 Pc.

Part #	1/8, 3/16, 1/4, 5/16, 3/8, 7/16, 1/2"	Qty of each
31580 AD-7	Acrylic Drills Super ChipFree™	1

29 Pc.

Part #	1/16 - 1/2" by 64ths	Qty of each
10390 SM-29	Screw Machine - 118° Point	1

60 Pc.

Part #	#1 - 60	Qty of each
35210 SM-60	Screw Machine - 118° Point	1

29 Pc.

Part #	1/16 - 1/2" by 64ths	Qty of each
25243 SMN-29	Titanium Nitride - Screw Machine	1

60 Pc.

Part #	#1 - 60	Qty of each
25253 SMN-60	Titanium Nitride - Screw Machine	1

BLACK OXIDE & TITANIUM NITRIDE - SCREW MACHINE LENGTH

Type 260-T Screw Machine Length
 NAS 907C Black Oxide
 135° Split point

- A sturdy drill for use in portable power drilling.
- Accurate centering, fast penetration. Ideal for thin metal work.

Type 260-TN Titanium Nitride NAS 907C
 Screw Machine Length
 Heavy-Duty 135° Split point

- A sturdy drill for use in portable power drilling.
- Accurate centering, fast penetration. Ideal for thin metal work.
- Titanium Nitride extends tool life.

10 Pc.

Part #	1/16 - 5/32" by 64ths + 3/16, 7/32, 1/4"	Qty of each
43660 T-10	Black Oxide - 135° Split point	1

11 Pc.

Part #	1/16 - 3/8" by 32nds	Qty of each
43670 T-11	Black Oxide - 135° Split point	1

13 Pc.

Part #	1/16 - 1/4 by 64ths	Qty of each
43690 T-13	Black Oxide - 135° Split point	1

21 Pc.

Part #	1/16 - 3/8" by 64ths	Qty of each
43710 T-21	Black Oxide - 135° Split point	1

29 Pc.

Part #	1/16 - 1/2" by 64ths	Qty of each
43730 T-29	Black Oxide - 135° Split point	1
96680 TN-29	Titanium Nitride - 135° Split point	1

60 Pc.

Part #	# 1 - 60	Qty of each
43750 T-60	Black Oxide - 135° Split point	1
96730 TN-60	Titanium Nitride - 135° Split point	1



TN-29



TN-60

Cutting Tool Sets - Black Oxide / TIN Coated Screw Machine Length

Cutting Tool Sets

SILVER & DEMING

Type 280-UB

1/2" Shank Silver & Deming
Ultra Bor Super Premium,
3-Flats on Shank
Heavy-Duty, 135° Split point

- 135° Split point for fast penetration and accurate starting without a center punch.
- One piece solid construction
- Sizes larger than 1" diameter have 118° Split point.
- Recommended for use in work hardening grades of stainless steel and other hard metal drilling applications.

Type 280-UBX

1/2" Shank Silver & Deming,
Premium - 3-Flats on Shank
118° Split point

- M2 High Speed Steel
- Precision ground point, flutes, body and clearance.
- 118° Split point for general purpose drilling in metal, wood and plastic.

Type 280-D

1/2" Shank Silver & Deming
M42 Cobalt 135° Split point
3 - flats on Shank

- Manufactured from M42 HSS containing 8% cobalt which increases high red hardness.
- Cobalt drills require rigidly held positive feed drilling equipment.

Type 280

1/2" Shank Silver & Deming
118° General Purpose

- This general purpose 118° point high-speed steel drill is recommended for use in portable air and electric drilling equipment with 1/2" chucks.
- **Type 280** drills may be used in power applications such as drill presses where a short rigid drill is required.

Type 280-MRO

Silver & Deming, 135° Split point,
3-Flats on Shank

- The **280-MRO** is a shorter (5") tougher version of our very popular 1/2" reduced shank product.
- Designed specifically for the needs of the MRO market, the **280-MRO** has a split point (135°) to insure fast hole starts without drill walking.
- This feature packed tool provides tremendous value for your drilling dollar.



S&D-4SP

4 Pc.

Part #	9/16, 5/8, 3/4, 1"	Qty of each
12260 S&D-4	1/2" Shank-Silver & Deming	1
12250 S&D-4SP	1/2" Shank-Silver & Deming	1
74771 S&D-4UBX	1/2" Shank-Silver & Deming	1
29551 S&D-4D	M42 Cobalt	1

8 Pc.

Part #	9/16 - 1" by 16ths	Qty of each
43200 S&D-8	1/2" Shank - Silver & Deming	1
92400 S&D-8SP	1/2" Shank - Silver & Deming	1
74781 S&D-8UBX	1/2" Shank - Silver & Deming	1
29571 S&D-8D	M42 Cobalt	1

33 Pc.

Part #	1/2 - 1" by 64ths	Qty of each
43201 S&D-33	1/2" Shank Silver & Deming 280	1
92401 S&D-33SP	1/2" Shank Silver & Deming 280-UB	1

4 Pc.

Part No.	Description of Sizes	Qty of each
54520 S&D-4MRO	9/16, 5/8, 3/4 & 1"	1

Cutting Tool Sets



Super Premium

WELDOUT™ SPOTWELD DRILLS SETS

- This rugged high performance drill is designed to effectively cut auto body panel spot welds.
- The high red hardness of cobalt steel permits speeds 30% greater than H.S.S. drills.
- Cobalt steel is substantially more abrasion resistant, resulting in long wearing cutting edges.
- A selection of the most popular sizes of spot weld drills in an attractive, rugged black steel case.



TYPE 493-D WO-4

Part #	Description of Sizes
35050	8.0mm & 10mm Single-end 8.0mm & 10mm Twin-end

TYPE 492-D WO-6

Part #	Description of Sizes
35010	6.5mm, 8.0mm & 10.0mm single-end drills. 6.5mm, 8.0mm & 10.0mm twin end drills.

LEFT HAND DRILL SETS

Type 240-AL

Ultra Bor Super Premium - Left Hand Spiral 135° Split point

- Precision ground point, flutes, body, clearance and drill diameter for the ultimate in accuracy and performance.
- Ideal for drilling broken studs.
- Need for screw and bolt extractor may be eliminated.

8 Pc.

Part No.	Description of Sizes	Qty of each
87650 LF-8	1/16, 1/8, 3/16, 1/4, 5/16, 3/8, 7/16, 1/2"	1

12 Pc.

Part No.	Description of Sizes	Qty of each
87651 LF-12	1/16 - 5/16" by 32nds, 3/8, 7/16 & 1/2"	1

13 Pc.

Part No.	Description of Sizes	Qty of each
87652 LF-13	1/16 - 1/4" by 64ths	1

15 Pc.

Part No.	Description of Sizes	Qty of each
87654 LF-15	1/16 - 1/2" by 32nds	1

17 Pc.

Part No.	Description of Sizes	Qty of each
87853 LF-17	1/16 - 1/4" by 64ths, 5/16 - 1/2" by 16ths	1

29 Pc.

Part No.	Description of Sizes	Qty of each
87854 LF-29	1/16 - 1/2" by 64ths	1

29 Pc. - Ultra Dex

Part No.	Description of Sizes	Qty of each
87859 LF-29P	1/16 - 1/2" by 64ths	1



BRAD POINT DRILLS

Type 16-UB

Jobber Length Burrout™ Brad Point Super Premium

- These high performance drills made from Hi-Moly tool steel will cut holes in wood or plastics and leave no burr.
- They will also drill splinter free holes in wood.
- The special BURROUT™ point cuts at the circumference of the hole to avoid the break through burr problems common with standard point drills.



10 Pc.

Part No.	Description of Sizes	Qty of each
42001 BR-10	5/64-3/16" by 64ths + 7/32, 1/4	1

14 Pc.

Part No.	Description of Sizes	Qty of each
42031 BF-14	5/64 - 3/16" by 64ths + 7/32, 1/4 - 1/2" by 16ths	1

Cutting Tool Sets - Spot weld Drill, Left Hand & Brad Point



Cutting Tool Sets

TAP & DRILL, COMBINATION DRILL & TAPS SETS

Type 40-UB NEW Combination Drill & Tap Sets - Super Premium



DT-7F

- Combination drill and taps are ideally suited for on-site tapping in construction, maintenance and repair, assembly, production and other applications where one pass drilling and tapping saves time and costs.
- Gold surface treatment for maximum lubricity.
- Self-centering helical point insures excellent drilling precision and accuracy.

Part No.	Description of Sizes
73991	7 pc set
40-UB - DT-7F	8-36, 10-32, 1/4-28,
Fine	5/16-24, 3/8-24, 7/16-20, 1/2-20

Part No.	Description of Sizes
73990	7 pc set
40-UB - DT-7C	8-32, 10-24, 1/4-20,
Coarse	5/16-18, 3/8-16, 7/16-14, 1/2-13

Part No.	Description of Sizes
21330	6 pc set
40-UB - DT-6	6-32, 8/32, 10-24, 10-32, 12-24, 1/4"-20

Part No.	Description of Sizes
21324	5 pc set
40-QR - DT-5	6-32, 8/32, 10-24, 10-32, 12-24, 1/4"-20



DT-6

TAP & DRILL SETS

Super Premium

- Hi-Molybdenum super premium twist drill combined with the corresponding Hi-Tungsten Ultra Bor Super Premium tap.
- Both tools are gold surface treated for maximum lubricity, and precision ground for the ultimate in accuracy and performance.

SP-18TD	SPIRAL POINT, NC
Part No.	Description of Sizes
57580	
240-UB Drill Sizes	#36, 29, 25, 21, 7, F, 5/16, U & 27/64
20-UB Tap Sizes	6-32, 8-32, 10-24, 10-32, 1/4-20 & 5/16-18, 3/8-16, 7/16-14 & 1/2-13

SP-18TDM	SPIRAL POINT, METRIC
Part No.	Description of Sizes
57990	
643-UB Drill Sizes (mm)	2.05, 2.50, 2.90, 3.30, 4.20, 5.00, 6.70, 8.50 & 10.20
21-UB Tap Sizes (mm)	2.5-.45, 3.0-.50, 3.5-.60, 4.0-.70, 5.0-.80, 6.0-1.00, 8.0-1.25, 10.0-1.50 & 12.0-1.75

SP-18TDF	SPIRAL POINT, NF
Part No.	Description of Sizes
58010	
240-UB Drill Sizes	#33, 29, 25, 21, 3, 1, Q, 25/64 & 29/64
20-UB Tap Sizes	6-40, 8-36, 10-24, 10-32, 1/4-28, 5/16-24, 3/8-24, 7/16-20 & 1/2-20

SP-12TD	SPIRAL POINT, NC
Part No.	Description of Sizes
58501	
240-UB Drill Sizes	#36, 29, 25, 21, 7, F
20-UB Tap Sizes	6-32, 8-32, 10-24, 10-32, 1/4-20 & 5/16-18

SF-18TDC	STRAIGHT FLUTE, NC
Part No.	Description of Sizes
60930	
240-UB Drill Sizes	#36, 29, 25, 21, 7, F, 5/16, U & 27/64
24-UB Tap Sizes	6-32, 8-32, 10-24, 10-32, 1/4-20, 5/16-18, 3/8-16, 7/16-14 & 1/2-13

SF-18TDF	STRAIGHT FLUTE, NF
Part No.	Description of Sizes
60940	
240-UB Drill Sizes	#33, 29, 25, 21, 3, 1, Q, 25/64 & 29/64
24-UB Tap Sizes	6-40, 8-36, 10-24, 10-32, 1/4-28, 5/16-24, 3/8-24, 7/16-20 & 1/2-20

SF-10TD	STRAIGHT FLUTE, NC
Part No.	Description of Sizes
58500	
240-UB Drill Sizes	31/64
280-UB Drill Sizes	17/32, 21/32, 49/64 & 7/8
24-UB Tap Sizes	9/16-12, 5/8-11, 3/4-10, 7/8-9 & 1-8

BRIGHT FINISH 118° POINT DRILL & HSS GENERAL PURPOSE TAPS	118° POINT DRILLS MAINT.
B-18TD	Part No.
Description of Sizes	Description of Sizes
60541	
240-B Drill Sizes	# 7, 21, 25, 29, 36, F, U, 5/16, 27/64
100 Drill Sizes	# 7, 21, 25, 29, 36, F, U
20 Tap Sizes	6-32, 8-32, 10-24, 10-32, 1/4-20 & 5/16-18, 3/8-16, 7/16-14, 1/2-13

Cutting Tool Sets



Super Premium

Cutting Tool Sets - Step Drills / Bolt Extractor / Countersink

STEP DRILL SETS

Type 78-UB & 78-UBN Titanium Nitride 3-Flatted Shank -- Type 78-QR & 78-QRN Titanium Nitride Quick Release Ultra™ Bit Super Premium, Multi-Diameter Step Drill 3-Flats on Shank

- Dual flute construction drills clean accurate holes in thin materials, quickly and easily.
- Use for all thin metals, rigid plastics and wood or composite materials with a thickness equal to or less than the step thickness.
- When drilling steel with 1/8" or greater thickness, a starter hole of the smallest step diameter will speed the drilling process.

TYPE 78-UB SETS

SETS - 3 & 4pcs.	Sizes
00721	1/8 - 1/2, 3/16 - 1/2, & 3/16 - 7/8"
00731	1/8 - 1/2, 3/16 - 1/2, & 9/16 - 1"
00741	1/8 - 1/2, 3/16 - 1/2, & 1/4 - 3/4"
00781 4pc.	1/8 - 1/2, 1/4 - 3/4, 1/4 - 7/8, 7/8 - 1-1/8"

TYPE 78-UBN TITANIUM NITRIDE - SETS

SETS - 3 & 4pcs.	Sizes
69230	1/8 - 1/2, 3/16 - 1/2, & 3/16 - 7/8"
69240	1/8 - 1/2, 3/16 - 1/2, & 9/16 - 1"
69250	1/8 - 1/2, 3/16 - 1/2, & 1/4 - 3/4"
68781 4pc.	1/8 - 1/2, 1/4 - 3/4, 1/4 - 7/8, 7/8 - 1-1/8"

TYPE 78-QR QUICK RELEASE SETS

SETS - 3 pc.	Sizes
01441	1/8 - 1/2, 3/16 - 1/2, & 3/16 - 7/8"
01451	1/8 - 1/2, 3/16 - 1/2, & 1/4 - 3/4"
01461	1/8-1/2, 3/16-7/8 & 7/8-1-1/8"

TYPE 78-QRN TITANIUM NITRIDE SETS NEW

SETS - 3 pc.	Sizes
68561	1/8 - 1/2, 3/16 - 1/2, & 3/16 - 7/8"
68571	1/8 - 1/2, 3/16 - 1/2, & 1/4 - 3/4"
68581	1/8-1/2, 3/16-1/2 & 7/8-1-1/8"



BOLT EXTRACTOR SETS

Type 420 & Type 421-UB Sets

- Left-hand spiral drills often eliminate the need for bolt extractors.
- Drill may loosen bolt stud with counter clockwise rotation.

Left Hand Drill - Spiral Bolt Extractor Sets

BR-8 - Type 420 & 240-AL

Part No.	Description of Sizes	Qty of each
88550	EX 1, 2, 3, 4 + 3/32, 1/8, 3/16, 1/4 drills	1

BR-10 - Type 420 & 240-AL

Part No.	Description of Sizes	Qty of each
58510	EX 1, 2, 3, 4, 5 + 3/32, 1/8, 3/16, 1/4, 5/16 drills	1

Bolt Extractor Set - Spiral Extractor

SE-4N - Type 420

Part No.	Description of Sizes	Qty of each
47170	EX 2, 3, 4, 5	1

SE-5N - Type 420

Part No.	Description of Sizes	Qty of each
47180	EX 1, 2, 3, 4, 5	1

Left Hand Drill - Square Extractor Set

BR-8SQ - Type 421-UB, Square & 240-AL

Part No.	Description of Sizes	Qty of each
70850	E 1, 2, 3, 4 + 1/8, 3/16, 1/4, 5/16	1

Bolt Extractor Sets - Square Extractor

SQE-4 - Type 421-UB

Part No.	Description of Sizes	Qty of each
70840	E 2, 3, 4, 5	1

CHATTERPROOF™ COUNTERSINK SETS SUPER PREMIUM

**Type 82-UB Countersinks
Type 90-UB Deburring Tools**



These high performance, flute-less tools are:

- Single cutting edge - for fast stock removal
 - Chatter-proof - for a micro smooth finish
 - Wide selection of styles & angles - a tool for any job
- Recommended for smoother finishes on metal, plastic and wood applications.

TYPE 82-UB & 90-UB SETS

Part No.	Description of Sizes
SP-4CS 10440	82-UB C/S sizes: CS5S, CS6S, CS5S, CS10S
SP-4ACS 10442	82-UB C/S sizes: CS6S, CS8S, CS10S, CS3/16S
SP-6DB 10450	90-UB D/B sizes: DB1/16, DB1/8, DB5/32, DB3/16, DB5/16 & DB9/16
SP-9CS 10443	82-UB C/S sizes: CS5S, CS6S, CS8S, CS10S, CS1/4, CS5/16, CS3/8, CS7/16, & CS1/2



Cutting Tool Sets

HOLE EXPANSION TOOLS

Type 50 -UB Car Reamers, Standard Flute 3-Flats on Shank



- Special Hi-Tungsten tool steel, gold surface treated body and clearance for maximum lubricity.
- These reamers are designed for the reaming of hardened steel commonly found in truck frames, rail cars, bridges, and pressure vessels.
- Use only to enlarge previously formed or drilled holes.

SET - Contains 1 ea.

12270	CR-4SP	3/8, 1/2, 5/8, 3/4
-------	--------	--------------------

Type 51-UB Car Reamers - Fast Spiral Hole Buster™ Super Premium 3-Flats on Shank



- Special Hi-Tungsten tool steel, gold surface treated body and clearance for maximum lubricity.
- These reamers are designed for the reaming of hardened steel commonly found in truck frames, rail cars, bridges, and pressure vessels.

SET - Contains 1 ea.

12271	CR-4FS	3/8, 1/2, 5/8, 3/4
12281	SM-4FS	5/16, 3/8, 7/16, 1/2

The 51-UB, with the fast spiral, is the more aggressive of the two styles. It also will fit the needs of users who prefer a stop collar.

HOLE HOG™ SETS

Type 284-UB Ultra Bor Super Premium 1/2" Shank (3-flats on shank) 4-Flute Core Drill

- A selection of core drills and companion (minimum starting hole size) pilot drills in a black steel index.



SP-8HH Set contains:

1 each: 284-UB core drill sizes 3/8, 1/2, 5/8 & 3/4
250-UB drill sizes 1/4, 5/16, 25/64 & 15/32

Part # 38880

SP-6HHL Set contains:

1 each: 284-UB core drill sizes 1/2, 5/8 & 3/4
250-UB drill sizes 5/16, 25/64 & 15/32

Part # 38870

SP-6HHS Set contains:

1 each: 284-UB core drill sizes: 3/8, 1/2 & 5/8
250-UB drill sizes 1/4, 5/16 & 25/64

Part # 38860

3pc. CARBIDE HOLE CUTTER SETS Type CHC-UB

- Ideal for stainless steel, structural steel studs and electrical boxes.
- Can be used on cast iron, brass, aluminum and other thin non-ferrous metals.
- Burr free holes.
- For material up to 3/16"



Size	Steel	Stainless Steel
11/16" to 13/16"	700-1000 RPM	300-700 RPM
7/8" to 1-3/16"	500-800 RPM	200-450 RPM
1-1/4" to 1-9/16"	300-600 RPM	175-315 RPM
1-5/8" to 2"	200-500 RPM	120-225 RPM
2-1/16" to 2-3/8"	200-400 RPM	95-195 RPM
2-7/16 to 3"	150-300 RPM	80-150 RPM

SET - Contains 1 ea.

62590	3pc.	7/8", 1-1/8" and 1-3/8"
-------	------	-------------------------

CARBIDE HOLE CUTTER SETS Type CHC-UB & CHD-UB



All Sets Packaged in Sturdy Steel Case!

Type CHC-UB Cuts up to 3/16" Thin Material

HC-4B Part # 62600

Set contains: 1 each:
Fractional sizes: 11/16, 13/16, 15/16, 1-1/16"

HC-4A Part # 62610

Set contains: 1 each:
Fractional sizes: 5/8, 3/4, 7/8, 1"

HC-5C Part # 62620

Set contains: 1 each:
Fractional sizes: 7/8, 1-1/8, 1-3/8, 1-3/4, 2"

CHC-UB Individual Sizes Available 9/16 to 5-inch

Type CHD-UB Cuts up to 1" Thick Material

HCD-4B Part # 64300

Set contains: 1 each:
Fractional sizes: 11/16, 13/16, 15/16, 1-1/16"

HCD-4A Part # 64310

Set contains: 1 each:
Fractional sizes: 5/8, 3/4, 7/8, 1"

HCD-5C Part # 64320

Set contains: 1 each:
Fractional sizes: 7/8, 1-1/8, 1-3/8, 1-3/4, 2"

Annular Cutter Sets132

Counter Displays

- Annular Cutter131
- Reamers Type 50-UB & Type 51-UB . . 132
- Silver & Deming131

Stock Master Dispensers & Displays

- Type 925 300pcs. Fractional130

Display Packages

- Type 250-UB140
- Type CHC-UB & CHD-UB140

Drill Gauges

- Type 913 Letter, Fractional & Wire . . 137

Drill Stand

- Type 913 Letter, Fractional & Wire . . . 137

Indexes

- Type 901 Indexes Only141
- Type 901 Black Indexes - ID Plate Slot . . 142

Master Drill Dispensers

- Type 913 U.S. & Metric Sizes135

Master Tap Dispensers

- Type 913136

Silver & Deming Drill Dispensers

- Type 913134

Stocking Cases

- 13 pc. Silver & Deming.133
- 72 pc. Letter133
- 91 pc. Metric133
- 96 pc. Fractional.133
- 249 pc. Wire.133

Carbide Holecutter Display

- Type CHC-UB140
- Type CHD-UB140

Tap & Die Countertops

- Tap & Round Die.138
- Tap & Hex Die138

Ultra Bor Super Premium

- 53-SF.138
- 55-SP.138

Tap & Drill Assortments

Super Premium

- 67-SP139
- 123-SP139
- 123-SF139

Drawer-Mount Dispensers

- Type 913
- Fractional, Wire, Letter & Empty134



Displays, Cabinets & Indexes - INDEX



Displays, Cabinets & Indexes

STOCK MASTER DISPENSERS & DISPLAYS

Type 925

Fractional Drills - 300 Piece Assortment

- Assortment is complete with lexan front display pictured on the left side of this page.
- Case stocks **29 fractional sizes -1/16" thru 1/2" by 64ths** - each size in a separate compartment.
- Individual compartments are plainly marked with drill sizes.
 - Drills will be attractively displayed yet secure with the lexan locking cover.



Counter Top Display are available stocked with Type 240-UB, 250-UB, 240-D, 240-A, 240, 240-B or 240-GF drills



Type 240-UB



Type 250-UB



Type 240

300pc. ASSORTMENT EACH. DISPLAY CONTAINS:

Assortment Drill			No. of Drills	Fractional Size
Part No.	No.	Type		
06490	300-SP	240-UB	24	1/16"
06520	300-HD	240-A	12	5/64"
54720	300-BR	240-B	24	3/32"
54750	300-BL	240	18	7/64"
57640	300-SPM	240	48	1/8"
57641	300-RSPM	250/258-UB	18	9/64"
68460	300-D	240-D	18	5/32"
40632	300-GF	240-GF	12	11/64"
			12	3/16"
			6	13/64"
			12	7/32"
			6	15/64"
			24	1/4"
			6	17/64"
			6	9/32"
			2	19/64"
			6	5/16"
			2	21/64"
			3	11/32"
			2	23/64"
			6	3/8"
			2	25/64"
			2	13/32"
			2	27/64"
			3	7/16"
			2	29/64"
			2	15/32"
			2	31/64"
			6	1/2"

ACCESSORIES

Part No.	Description	Qty. per/pack
58350	Replacement Lock & key	1

DISPLAY ONLY
Part #45010

Total 300

SILVER DEMING DISPLAY

Silver & Deming Drills

- Compact Lexan case attractively displays S&D drills.
- Scratch proof Lexan front reduces pilferage and keeps merchandise clean.



SILVER & DEMING COUNTER DISPLAY		
Contents	Part No. 00940	No. of Each
Type 280-UB	9/16, 5/8, 11/16, 3/4, 13/16, 7/8, 15/16 & 1"	1

DISPLAY ONLY
Part #00934

LEXAN COUNTER DISPLAY - ANNULAR CUTTERS

Annular Cutters

- Compact metal case attractively displays annular cutters.
- Scratch proof Lexan front reduces pilferage and keeps merchandise clean.



DISPLAY CONTENT

1 of each, 1/2", 9/16", 5/8", 11/16",
3/4", 13/16", 7/8", 15/16", 1"
1-1/16" by 1" depth and same sizes as
above by 2" depth.
Both include five pins.



ANNULAR CUTTERS COUNTER DISPLAY	
Part No.	Size/Type
00943	SB-20 /15 & 15L
00944	SB-20HS /14 & 14L
00949	SB-20SP/13SP & 13LSP

DISPLAY ONLY
Part #00939

Display, Cabinets & Indexes - Silver & Deming / Annular Cutters



Displays, Cabinets & Indexes

REAMER COUNTER DISPLAY

Type 50-UB -Standard Flute **Type 51-UB -Fast Spiral**
Reamers



CR8SPA

- Compact case attractively displays reamers.
- Scratch proof Lexan front reduces pilferage and keeps merchandise clean.

Part #	Type	Contents	No. of Each
00941	CR8SPA 50-UB	3/8, 1/2, 9/16, 5/8, 11/16, 3/4, 7/8, 1"	1
00942	CR8FSA 51-UB	3/8, 1/2, 9/16, 5/8, 11/16, 3/4, 7/8, 1"	1

Display Only Part #00934

SPIRA-BROACH™ - ANNULAR CUTTERS SETS

- These unique cutters reduce time and power requirements by cutting larger diameter holes as a ring to produce a solid slug.
- The effort required is a fraction what is needed when using a twist drill or indexable tooling.



SPIRA-BROACH™ Annular Cutters

- Give the lowest cost per hole
 - Cut on curved surfaces
 - Leave a burr-free hole
 - Use less power
- Allow overlapping cuts on existing holes
- Stay sharp much longer



SB-5 1" LENGTH

Part No.	Type	Components
15301	M-42 15	1" Pin 9/16, 11/16, 13/16, 15/16 & 1-1/16
16901	M-35 14	1" Pin 9/16, 11/16, 13/16, 15/16 & 1-1/16
16624	M-2 13SP	1" Pin 9/16, 11/16, 13/16, 15/16 & 1-1/16

SB-5 2" LENGTH

Part No.	Type	Components
15302	M-42 15L	2"Pin 9/16, 11/16, 13/16, 15/16 & 1-1/16
16902	M-35 14L	2"Pin 9/16, 11/16, 13/16, 15/16 & 1-1/16
16629	M-2 13LSP	2"Pin 9/16, 11/16, 13/16, 15/16 & 1-1/16

STOCKING CASES, FRACTIONAL, WIRE, LETTER, METRIC & SILVER DEMING ASSORTMENT

Type 925

Closed Drawer All-Steel Stocking Units

Stocking cases for Fractional, Wire Gauge, Letter, Metric, and Silver & Deming drills.



Fractional & Metric Sizes = 3 Drawers
 Wire Sizes = 5 Drawers
 Letter Sizes = 3 Drawers
 Silver & Deming = 4 Drawers

FRACTIONAL DRILLS

Part No.	Assortment No.	Drill Type
06500	96-SP	240-UB
16010	96-HD	240-A
37270	96-SPM	250-UB
54690	96-BR	240-B
54760	96-BL	240
68440	96-D	240-D
37271	96-RSPM	250/258-UB

FRACTIONAL DRILLS - 96PCS. ASSORTMENT

Drill Size - Contains	Quantity
1/16, 3/32, 1/8, 5/32, 11/64, 3/16, 7/32 & 1/4	6 each
5/64, 7/64, 9/64, 13/64, 15/64, 9/32, 5/16, 11/32	3 each
17/64, 21/64, 23/64, 3/8, 25/64, 13/32, 27/64, 7/16 & 29/64	2 each
15/32 & 1/2	1 each
19/64 & 31/64	1 each

WIRE GAUGE

Part No.	Assortment No.	Drill Type
16030	249-HD	240-A
35070	249-SP	240-UB
54700	249-BR	240-B
54770	249-BL	240

WIRE GAUGE DRILLS - 249 PC. ASSORTMENT

Drill Size - Contains	Quantity
1-22	3 each
23-29	4 each
30-60	5 each

LETTER DRILLS

Part No.	Assortment No.	Drill Type
16020	72-HD	240-A
35080	72-SP	240-UB
54710	72-BR	240-B
54780	72-BL	240

LETTER DRILLS - 72 PC. ASSORTMENT

Drill Size - Contains	Quantity
A-T	3 each
U-Z	2 each

METRIC DRILLS

Part No.	Assortment No.	Drill Type
18910	91-SP	643-UB

METRIC DRILLS - 91pc. ASSORTMENT

Drill Size - Contains	Quantity
2.5, 3.5, 4.5, 5.0, 5.5, 6.0 & 6.5	5 each
1.5, 2.0, 3.0, 7.0, 8.0 & 8.5	4 each
1.0, 4.0, 9.0, 9.5, 10.0, 10.5, 11.0 & 12.0	3 each
7.5, 11.5, 12.5 & 13.0	2 each

SILVER & DEMING

Part No.	Assortment No.	Drill Type
43202	S&D 13	280
92402	S&D 13-SP	280-UB

SILVER & DEMING - 13PCS. ASSORTMENT

Drill Size - Contains	Quantity
9/16 & 5/8	3
3/4	2
11/16, 13/16, 7/8, 15/16 & 1"	1

Display, Cabinets & Indexes - Fractional, Wire, Letter, Metric Assortments

SILVER & DEMING DISPENSERS

Type 913



HUOT MODEL 13166

Part No.	Dimensions Inches	Weight per/pack	Qty.
00950	14-5/8" W x 7-3/8" D x 7-3/4" H	13-1/4 lbs.	1

Holds: 2 each Reduced Shank S & D bits from 33/64ths to 63/64ths by 64ths.



HUOT MODEL 13167

Part No.	Dimensions Inches	Weight per/pack	Qty.
00951	14-5/8" W x 7-3/8" D x 7-3/4" H	10-3/4 lbs.	1

Holds: 2 each Reduced Shank S & D bits from 1, 1-1/32, 1-1/16, 1-1/8, 1-5/32, 1-3/16, 1-1/4, 1-5/16, 1-3/8, 1-7/16 & 1-1/2.

DRAWER-MOUNT DRILL ORGANIZER

Type 913

Drawer-Mount

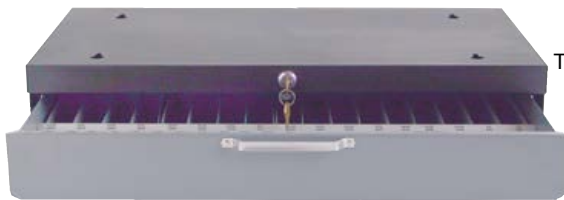

The latest thing in organizing, sorting, storing, and securing your cutting tools. The outer shell can be mounted underneath a work bench, desk, shelf, inside a cabinet, or just about anywhere. The drawer has a cam-lock to keep your cutting tools safely locked away.

Overall Dimensions: 26-1/8" W x 12-1/2" D x 4-1/2" H

Drawer Dimensions: 23-1/8" W x 11" D x 3" H

Shipping Weight: 14-1/2 pounds

- Workbench-space-saver.
- Out-of-the way convenience.
- Security-Built in cam lock and two keys.
- Heavy-duty ball bearing drawer slides.
- Time-saving Cutting tools are stored away in their proper locations making it fast and easy to find the right tool.
- Each space clearly marked for the proper tool.
- Decimal equivalent shown under each size tool.

PART NO. 01021

Huot Model 30000
For Fractional Drills 1/16" to 1/2" x 64ths.

PART NO. 01023

Huot Model 30050
For Letter Drills from A to Z

PART NO. 01022

Huot Model 30025
For Wire Gauge Drills #1 to #60.

PART NO. 01024

Huot Model 30001
Empty drawer-mount drawer, no dividers
for miscellaneous storage space.

MASTER DRILL DISPENSERS

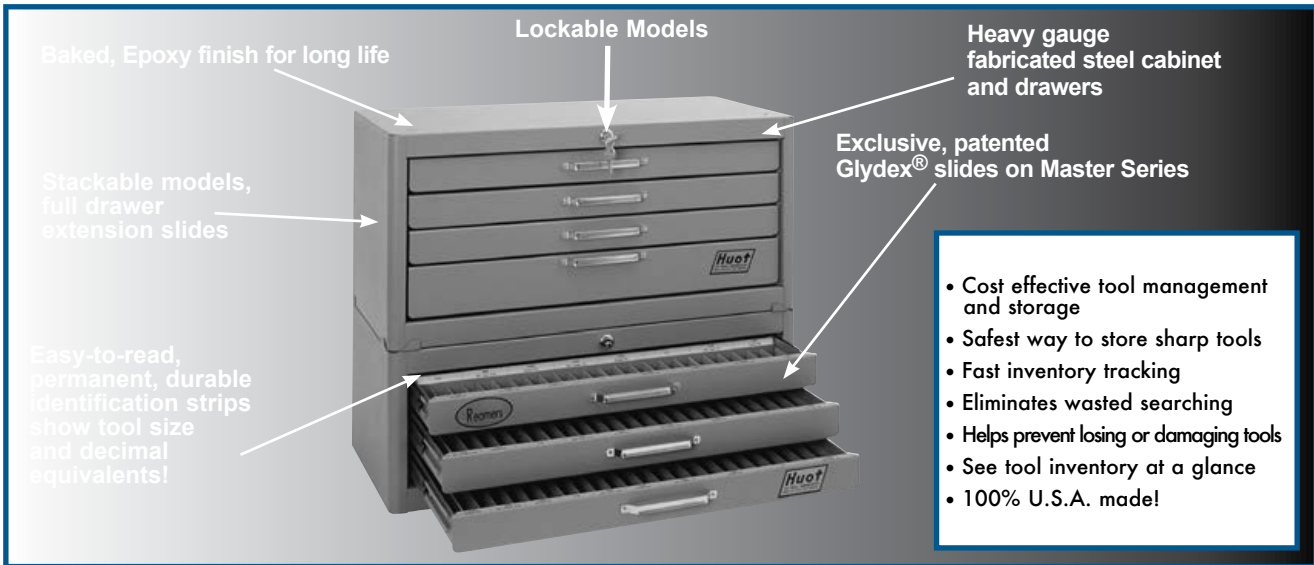

- Cost effective tool management and storage
- Safest way to store sharp tools
- Fast inventory tracking
- Eliminates wasted searching
- Helps prevent losing or damaging tools
- See tool inventory at a glance
- 100% U.S.A. made!

Type 913

Master Drill Dispensers (U.S. and Metric Sizes)

Feature:

- All steel cabinet with vinyl dividers to help protect and separate bits.
- Each cabinet is lockable with its own set of 2 keys.
- Each drawer measures 23-1/8" wide; 11" front to back.
- Stackable for larger inventories at one location.
- Lower drawer is undivided for extra long drills, reamers, and miscellaneous tools.
- Drawer Divider Kit available for lower drawer.

U.S. Sizes

Part No. 00682

Holds full packages (minimum of 12 pc.) of jobber or screw machine length drills, fractional, letter, and wire gauge sizes in one complete cabinet.

- Top drawer holds fractional drills 1/16" to 1/2" by 64th with 42 compartments.
- 2nd drawer is for #1 to #60 wire gauge with 75 compartments.
- 3rd drawer for letter size A to Z with 42 compartments.

HUOT MODEL 13175 - U.S. SIZE DRILLS

Part No.	Dimensions Inches	Weight	Qty. per/pack
00682	26" W x 12" D x 12 - 1/2" H	43 lbs.	1

Metric Sizes

Part No. 00681

Holds metric drills from .35mm to 13.00mm.

Sizes include: .35mm to 2.50mm by .05mm, 2.6mm to 10.0mm by .1mm, 10.2mm, 10.5mm, 10.8mm, 11.0mm, 11.2mm, 11.5mm, 11.8mm, 12.0mm, 12.2mm, 12.5mm, and 13.0mm.

138 compartments to store and inventory all your metric drill bits. Same great features as our #00682 jobber length master cabinet.

HUOT MODEL 13180 - METRIC SIZE DRILLS

Part No.	Dimensions Inches	Weight	Qty. per/pack
00681	26" W x 12" D x 12 - 1/2" H	43 lbs.	1

Display, Cabinets & Indexes - Master Drill Dispensers



MASTER TAP DISPENSERS

Type 913

- Holds most common NC/NF sizes from 1/4" to 1-1/2".
- Holds metrics from 2.5 mm to 30 mm.
- Holds machine screw size 2-56 thru 12-28, taper, plug, bottom, and spiral.
- Extruded vinyl drawer dividers protect taps.
- Top drawer has 40 compartments.
- Second drawer has 78 compartments.
- Third drawer has 21 compartments.
- Fourth drawer has 13 compartments.
- Stackable for larger inventories.
- Lockable.

Part # 01322

For sizes 1/4"-20 to 1"-14 taps
Many compartments hold multiples of a given size tap.

Holds bottom, plug and taper of each size:

1/4"-20	1/4"-28	5/16"-18	5/16"-24	3/8"-16	3/8"-24
7/16"-14	7/16"-20	1/2"-13	1/2"-20	9/16"-12	9/16"-18
5/8"-11	5/8"-18	3/4"-10	3/4"-16	7/8"-9	7/8"-14

1"-8 1"-14

Holds taper, plug, bottom and spiral:

2-56	3-48	3-56	4-40	4-48	5-40
5-44	6-32	6-40	8-32	8-36	10-24
10-32	12-24	12-28			

Part # 01321

HUOT MODEL 13585

Part No.	Dimensions Inches	Weight	Qty. per/pack
01321	26" W x 12" D x 12 - 1/2" H	46 lbs.	1

HUOT MODEL 13580

Part No.	Dimensions Inches	Weight	Qty. per/pack
01322	26" W x 12" D x 12 - 1/2" H	46 lbs.	1

MASTER TAP DISPENSERS

Type 913

- Holds all sizes of National Pipe taps (NPT) from 1/16 to 2
- Top drawer has 13 compartments measuring 3/4 W x 7/8 H x 4-1/2 D.
- 2 compartments for 1/16-27, 2 for 1/8-27, 3 for 1/4-18, 3 for 3/8-18 and 3 for 1/2-14.
- Middle drawer has 9 compartments for 3 for 3/4-14, 3 for 1-11-1/2, 3 for 1-1/4-11-1/2.
- Bottom drawer has 7 compartments measuring 1-3/4 W x 2 H x 7 D.
- 3 compartments for 1-1/2-11-1/2 and 1 large compartment for 2-11-1/2

Part # 01323

HUOT MODEL 13560

Part No.	Description	Qty. per/pack
01323	National Pipe Taps (NPT)	1

HUOT MODEL 13595

Part No.	Description	Qty. per/pack
01324	Taps, Drill & Dies	1



Part # 01324

Holds Metric, Taps, Drills and Dies.

From 2.5 x .45 tap to 12.0 x 1.75 tap and holds the following sizes:

- Top drawer holds 2.5 x .45 tap - 2.05 drill dies, 3.0 x .50 tap - 2.50 drill - dies, 3.5 x .60 tap - 2.90 drill - dies, 4.0 x .70 tap - 3.30 drill-dies.
- Middle drawer holds 5.0 x .80 tap - 4.20 drill-dies, 6.0 x 1.00 tap - 5.00 drill-dies, 8.0 x 1.25 tap - 6.70 drill-dies.
- Bottom drawer holds 10.0 x 1.50 tap - 8.50 drill-dies, 12.0 x 1.75 tap - 10.20 drill-dies.
- Room in top drawer for your T-handle wrench.

DRILL STANDS

Type 913

- These drill stands can be hung on a wall, used on a bench, or mounted on a press.
- Durably made from a single piece of prime steel, rigidly formed.

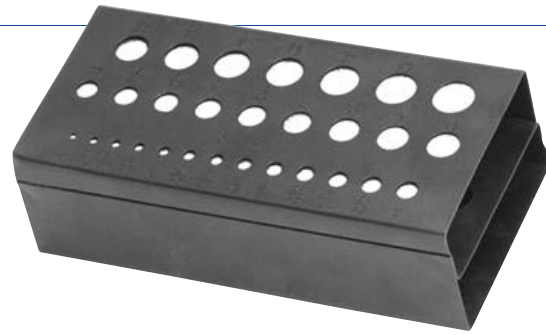

Part # 01011

Letter sizes A to Z inclusive

Part # 01012

Fractional drills 1/16" to 1/2" by 64ths inclusive

Part # 57430

Silver & Deming drills from 1/2-1 by 64ths. Held by shank.

HUOT MODEL 11850 PART #01011

Part No.	Dimensions Inches	Qty. per/pack
01011	5-5/8" W x 2-5/8" D x 1-1/2" H	1

HUOT MODEL 11985 PART #57430

Part No.	Dimensions Inches	Qty. per/pack
57430	13" W x 5" D x 2" H	1

HUOT MODEL 11900 PART #01012

Part No.	Dimensions Inches	Qty. per/pack
01012	5-5/8" W x 2-5/8" D x 1-1/2" H	1

DRILL GAUGES

Type 913

- Economical gauge made from prime steel and finished.

Part # 58520

For measuring 1/16" to 1/2" by 64ths drill bits.

Part # 58522

For measuring #1 to 60 wire gauge drill bits.

Part # 58521

For measuring drills 1/2" to 1" by 64ths.



Part # 58521

HUOT MODEL 12250 PART #58520

Part No.	Dimensions Inches	Qty. per/pack
58520	6" W x 3" D	1

HUOT MODEL 12280 PART #58521

Part No.	Dimensions Inches	Qty. per/pack
58521	13" W x 5" D	1

HUOT MODEL 12260 PART #58522

Part No.	Dimensions Inches	Qty. per/pack
58522	5-1/4" W x 2" D	1

Displays, Cabinets & Indexes

STOCKED COUNTER DISPLAYS

- Compact metal case attractively displays complete assortment of taps, dies, and wrenches.
- Locking scratch proof Lexan front reduces pilferage and keeps merchandise clean.
- Broad range of sizes. Practically all customers can be served with small investment.
- Price strips furnished on each display for quick reference at point of sale
- Furnished with hex or round dies.

Part # 50010 - Display with Round Dies
Part # 50210 - Display with Hex Dies

DISPLAY ONLY
 #45000



DISPLAY CONTENTS

Contents	Size	No. of Each
Plug Tap	1/4-20 NC	6
	1/4-28 NF	6
	5/16-18 NC	6
	5/16-24 NF	6
	3/8-16 NC	6
	3/8-24 NF	6
	7/16-14NC	6
	7/16-20NF	6
	1/2-13 NC	6
	1/2-20 NF	6
	9/16-12NC	6
	9/16-18NF	6
	5/8-11NC	6
	5/8-18NF	6
	3/4-10NC	6
	3/4-16NF	6
	4-40NC	12
	6-32NC	12
	8-32NC	12
	10-24NC	12
10-32NF	12	
12-24NC	12	
Pipe Tap	1/8-27NPT	6
Round or Hex Die	1/4-20NC	3
	1/4-28NF	3
	5/16-18NC	3
	5/16-24NF	3
	3/8-16NC	3
	3/8-24NF	3
	7/16-14NC	3
	7/16-20NF	3
	1/2-13NC	3
	1/2-20NF	3
	9/16-12NC	3
	9/16-18NF	3
	5/8-11NC	3
	5/8-18NF	3
	3/4-10NC	3
	3/4-16NF	3
	4-40NC	3
	6-32NC	3
	8-32NC	3
	10-24NC	3
10-32NF	3	
12-24NC	3	
1/8-27NPT	3	
T-Handle Tap Wrench	0 to 1/4"	3
T-Handle Tap Wrench	3/16" to 1/2"	3
Economy Die Stock	1" Round Hex	3

When Ordering Specify: Round or Hex Dies

TAP & DIE COUNTER-TOP

Ultra Bor Super Premium

53 Piece - Straight Flute Taps & Hex Dies
 Super Premium Tap & Die Counter Top Dispenser

53-SF Assortment contains:

Super premium straight flute plug tap sizes:

- 3 each** 6-32, 8-32, 10-24, 10-32 & 1/4-20;
- 2 each** 5/16-18, 3/8-16, 7/16-14 & 1/2-13;
- 1 each** 4-40, 12-24, 1/4-28, 5/16-24, 3/8-24, 7/16-20, 1/2-20, 9/16-12, 5/8-11 & 3/4-10.

Super premium hex die sizes:

- 1 each** 4-40, 6-32, 8-32, 10-24, 10-32, 12-24, 1/4-28, 5/16-18, 5/16-24, 3/8-16, 3/8-24, 7/16-14, 7/16-20, 1/2-13, 1/2-20, 9/16-12, 5/8-11 & 3/4-10;
- 2 each** 1/4-20.

Includes glass front stocking cabinet.

PART # 35150

55 Piece - Spiral Point Taps & Hex Dies
 Super Premium Tap & Die Counter Top Dispenser

55-SP Assortment contains:

Super premium spiral point tap sizes:

- 3 each** 6-32, 8-32, 10-24, 10-32 & 1/4-20;
- 2 each** 5/16-18, 3/8-16, 7/16-14 & 1/2-13;
- 1 each** 4-40, 12-24, 1/4-28, 5/16-24, 3/8-24, 7/16-20, 1/2-20, 5/8-11, 5/8-18, 3/4-10 & 3/4-16.

Super premium hex die sizes:

- 1 each** 4-40, 6-32, 8-32, 10-24, 10-32, 12-24, 1/4-28, 5/16-18, 5/16-24, 3/8-16, 3/8-24, 7/16-14, 7/16-20, 1/2-13, 1/2-20, 5/8-11, 5/8-18, 3/4-10 & 3/4-16
- 2 each** 1/4-20.

Includes glass front stocking cabinet.

PART # 35160

TAP & DRILL ASSORTMENTS

Ultra Bor Super Premium

- Special Hi-Tungsten and Hi-Molybdenum tool steels, gold surface treated for maximum lubricity.
- Recommended for use in production tapping and drilling of work hardening grades of stainless steel and other hard metal applications.
- Precision ground tap threads for the ultimate in accuracy and performance.



**CABINET ONLY
PART #35100**

67pc.

Super Premium Tap & Drill Dispenser Assortment Spiral Point Taps & Jobber Length Drills

67-SP Assortment contains:

Type 190-AG - Super premium Jobber drill sizes:

- 6 each #36, 29, 25, 21
- 3 each #7, F & 5/16
- 2 each #3, I, Q, U, 25/64, 27/64 & 29/64

Type 20-AG - Super premium Spiral point plug tap sizes:

- 3 each 1/4-20
- 2 each 6-32, 8-32, 10-24, 10-32 and 1 each 1/4-28, 5/16-18, 5/16-24, 3/8-16, 3/8-24, 7/16-14, 7/16-20, 1/2-13 & 1/2-20

Includes 3 drawer stocking cabinet.

PART # 35121

123pc.

Super Premium Tap & Drill Dispenser Assortment Spiral Point Taps & Jobber Length Drills

123-SP Assortment contains:

Type 190-AG - Super premium Jobber drill sizes:

- 12 each #36, 29, 25, 21
- 6 each #7, F & 5/16
- 3 each #3, I, Q, U, 25/64, 27/64 & 29/64

Type 20-AG - Super premium Spiral point plug tap sizes:

- 6 each 1/4-20
- 3 each 6-32, 8-32, 10-24, 10-32, 5/16-18 & 3/8-16
- 2 each 1/4-28, 5/16-24, 3/8-24, 7/16-14 & 1/2-13
- 1 each 7/16-20 & 1/2-20

Includes 3 drawer stocking cabinet

PART # 35120

123pc.

Super Premium Tap & Drill Dispenser Assortment Straight Flute Taps & Jobber Length Drills

123-SF Assortment contains:

Type 190-AG - Super premium Jobber drill sizes:

- 12 each #36, 29, 25, 21
- 6 each #7, F & 5/16
- 3 each #3, I, Q, U, 25/64, 27/64 & 29/64

Type 24-AG - Super premium Straight flute plug tap sizes:

- 6 each 1/4-20
- 3 each 6-32, 8-32, 10-24, 10-32, 5/16-18 & 3/8-16
- 2 each 1/4-28, 5/16-24, 3/8-24, 7/16-14 & 1/2-13
- 1 each 7/16-20 & 1/2-20

Includes 3 drawer stocking cabinet

PART # 35110

DISPLAY PACKAGES

Type 250-UB

Mechanic Length Drills
Ultra Bor Super Premium -
Black & Gold - 135° Split Point

- Super premium drills in attractive, displays.
- All drills are packed on cards with logo and scan able bar code.
- **250-UB drills** with flatted reduced shanks are used where indicated.



All displays contain an attractive header card and 1/4" peg board fasteners.

DISPLAY NO. DC145SP

Part # 81651

Contents	Size	No. of Cards
250-UB	3/16, 1/4	5
1/16 thru 1/2	1/16, 5/64, 3/32, 7/64, 1/8, 5/16	4
	9/64, 5/32, 11/64, 13/64, 7/32	3
	15/64, 3/8	2
	17/64, 9/32, 19/64, 21/64, 11/32	
	23/64, 7/16, 1/2	1
	25/64, 13/32, 27/64, 29/64	
	15/32, 31/64	

* 1/16 thru 1/8 = 3 per card, 9/64" thru 1/4" = 2 per card

DISPLAY NO. DC116SP

Part # 81631

Contents	Size	No. of Cards
250-UB 1/16 thru 13/32	1/8	7
	1/16, 3/32	5
	5/32	3
258-UB 7/16 thru 1/2	1/4	7
	3/16, 5/16	6
	9/32, 11/32, 3/8	4
	13/32, 7/32, 7/16	3
	1/2	2
	15/32	1

DISPLAY NO. DC72SP

Part # 81641

Contents	Size	No. of Cards
250-UB 1/16 thru 3/8	1/8	7
	1/16, 3/32	5
	5/32	3
258-UB 7/16 thru 1/2	1/4	7
	3/16, 5/16	6
	3/8	4
	7/32, 7/16	3
	1/2	2

* 1/16 thru 1/8 = 3 per card, 9/64" thru 1/4" = 2 per card

Type CHC-UB

Carbide Tipped Hole cutter Display
Ultra Bor Super Premium

- Ultra Bor Super Premium Carbide Tipped Hole cutters are made with ultra-hard tungsten carbide teeth for cutting through tough alloys.
- The design provides sharp, crisp cuts without burrs and prevents over penetration.
- The built-in pilot drill with ejector spring quickly discharges the slug effortlessly.



Display Rack Only

Part # 14120

CARBIDE HOLE CUTTERS DISPLAY

Part # 62700

Contents	Size	No. of Each
CHC-UB	13/16, 7/8, 15/16, 1"	1
Depth of cut	1-1/16, 1-1/8, 1-3/16, 1-1/4, 1-3/8	
	3/16"	
CHD-UB	13/16, 7/8, 15/16, 1"	1
Depth of cut	1-1/16, 1-1/8, 1-3/16, 1-1/4, 1-3/8	
	1"	
Display Rack	16" width x 27" height	1
<i>(Display Rack Only Part # 14120)</i>		

INDEXES ONLY

Type 901

Jobber Indexes

Part No.	Description	Qty. per/pack
43870	I-11	1
43760	I-13	1
49044	I-13M	1
43770	I-15	1
43780	I-20	1
43790	I-21	1
43880	I-25	1
43800	I-26	1
43810	I-29	1
49049	I-41	1
43860	I-60	1
43940	I-115	1
43850	H-13	1



Plastic Indexes & Cases

Part No.	Description	Qty. per/pack
44000	I3-PL	1
44020	I-25TDI	1
44040	I-40TDI	1
61670	I-58TDI	1

Silver & Deming Indexes

Part No.	Description	Qty. per/pack
57440	ISD-8SP	1
43930	I-SD	1
12240	PL-4SD	1
12243	PL-8SD	1
57430	A-33	1

Screw Machine Indexes

Part No.	Description	Qty. per/pack
43890	S-13	1
43900	S-21	1
43910	S-29	1
43920	S-60	1

BLACK INDEXES - ID PLATE SLOT

Type 901



Display, Cabinets & Indexes - Black Indexes / ID Plate Slot

Jobber Indexes

Part No.	Description	Qty. per/pack
28580	I-3SP	1
57460	I-13SP	1
57470	I-15SP	1
57480	I-21SP	1
57490	I-26SP	1
57500	I-29SP	1
57510	I-60SP	1
57520	I-115SP	1
58930	I-25SP	1
99860	I-21SPR	1

Screw Machine Index

Part No.	Description	Qty. per/pack
23250	I-29SPT	1

Silver & Deming Indexes

Part No.	Description	Qty. per/pack
57440	ISD-8SP	1

Hole Hog™ Index

Part No.	Description	Qty. per/pack
38850	I-8HH	1

Tap & Drill Indexes

Part No.	Description	Qty. per/pack
58320	I-10TD	1
57570	I-18TD	1
57980	I-18TDM	1
58000	I-18TDF	1
58502	I-12TD	1

Drill & Extractor Index

Part No.	Description	Qty. per/pack
58331	I-BRSQ	1

Tap Indexes

Part No.	Description	Qty. per/pack
61630	I-19T	1
61640	I-10T	1

Spotweld™ Indexes

Part No.	Description	Qty. per/pack
35000	I-6WO	1
16040	I-4WO	1