



Grooving, Cut-Off, and Turning

Grooving Application Guide	D2-D3
WMT™ Grooving, Cut-Off, and Turning	D4-D29
TopGroove™	D30-D71
ProGroove™	D72-D85
Separator™	D86-D107
Ranger™ Face Grooving	D108-D115
S-LOC™ Grooving	D116-D121
Chipmaker™	D122-D135



Grooving

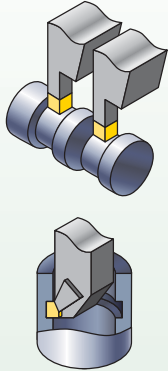

WMT™

- Insert cutting widths: .079"–.315" (2,0mm–8,0mm).
- OD cutting depths: .65"–1.0" (16,5mm–25,4mm).
- ID boring bar minimum bore diameter: 2.25" (57,15mm).
- Screw-clamping integral shank/cartridge toolholders available.
- Geometry for deep grooving.

Pages:
D4–D29



TopGroove™

- Insert cutting widths: .02"–.25" (0,5mm–6,35mm).
- Insert cutting depths: .025"–.50" (0,64mm–12,7mm).
- ID boring bar minimum bore diameter: .440" (11,2mm).
- Integral shank toolholders available.

Pages:
D30–D71



ProGroove™

- Insert cutting depths: .394"–1.58" (10,0mm–40,0mm).
- Inserts enable precision sintered execution, good tolerances, and repeatability.
- Screw-clamping integral shank toolholders available.
- Grooving and OD turning.

Pages:
D72–D84



Chipmaker™

- Insert cutting widths: .118"–.376" (3,0mm–9,53mm).
- OD cutting depths: .312"–1.5" (7,9mm–38,1mm).
- Screw-clamping integral shank/cartridge toolholders available.
- Multiple insert geometries for deep grooving.

Pages:
D122–D135

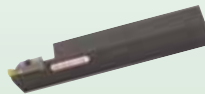

S-LOC™

- Insert cutting widths: .041"–.108" (1,04mm–3,81mm).
- Maximum cutting depth: .094" (2,4mm).
- ID boring bar minimum bore diameter: 14,2mm (.560").
- Inserts for boring or threading available.
- Screw-clamping integral shank holder for ID applications.

Pages:
D116–D121

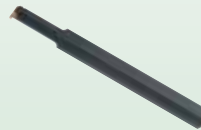

LG

- Insert cutting widths: .315"–.630" (8,0mm–16,0mm).
- OD cutting depths: .787"–1.26" (20,0mm–32,0mm).
- Wedge-clamping integral shanks tooling available.

Pages:
D75–D84

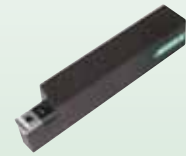

Cut-Off

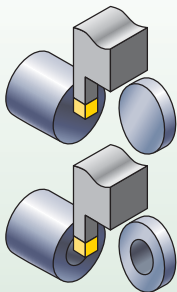

WMT

- Cut-off widths: .059"–.157" (1,5mm–4,0mm);
- Maximum cutting depth: .857" (22,2mm).
- Screw-clamping integral shank/cartridge toolholders available.
- Economical double-sided inserts for rigidity and dimensional accuracy.
- Right-/left-hand styles: 5° and 12° lead angles.

Pages:
D4–D29



Separator™

- Cut-off widths: .079"–.157" (2,0mm–4,0mm).
- Positive mechanical, self-clamping blades.
- Right-/left-hand style toolholders available.
- Single-edge inserts for maximum depth capacity.

Pages:
D86–D103

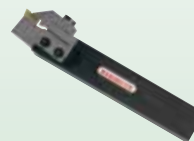

ProGroove

- Cut-off widths: .079"–.315" (2,0mm–8,0mm).
- Single-edge inserts for maximum depth capacity.
- Right-/left-hand styles with 6° lead angles.
- Self-clamping blades/screw-clamping integral shank toolholders available.

Pages:
D72–D84



Plunge and Turn

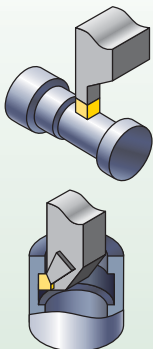

WMT

Heavy Stock Removal in Turning Applications

- Double-sided inserts, cutting widths: .079"–.315" (2,0mm–8,0mm).
- OD cutting depths: .650"–1.0" (16,5mm–25,4mm).
- ID boring bar minimum bore diameter: 2.25" (57,15mm).
- Screw-clamping integral shank/cartridge toolholders available.

Pages:
D4–D29



ProGroove

For Light-Cutting Inserts

- Cutting widths: .079"–.315" (2,0mm–8,0mm).
- OD cutting depths: .394"–1.58" (10,0mm–40,0mm).
- Single-edge inserts for maximum depth capacity.
- Screw-clamping integral shank toolholders available.

Pages:
D72–D84

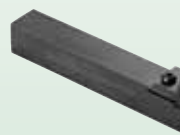

Chipmaker

Heavy Stock Removal in Plunge Mode Applications

- Insert cutting widths: .118"–.376" (3,0mm–9,53mm).
- OD cutting depths: .312"–1.5" (7,9mm–38,1mm).
- ID boring bar minimum bore diameter: .984" (25,0mm).
- Variety of geometries for deep grooving.
- Screw-clamping integral shank/cartridge toolholders available.

Pages:
D122–D135

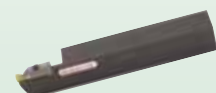

Face Grooving

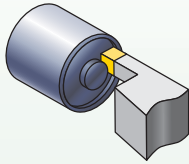

WMT

- Cutting widths: .118"–.250" (3,0mm–6,35mm).
- Cutting depths: .5"–1.0" (13,0mm–25,4mm).
- Minimum face groove diameter: 1.5"–8.0" (38,0mm–205,0mm).

Pages:
D4–D29



Ranger™

- Cutting widths: .126"–.25" (3,18mm–6,35mm).
- Cutting depths: .75"–1.00" (19,0mm–25,4mm).
- Minimum face groove OD diameter: 2.25"–16" (57,0mm–400,0mm).
- Square right-angle shank and round shank toolholders available.
- Screw-clamping, adjustable cartridge toolholders with different widths and spindle rotations.

Pages:
D108–D114



S-LOC

- Cutting widths: .041"–.108" (1,04mm–3,81mm).
- Maximum cutting depth: .094" (2,4mm).
- Minimum face groove diameter: .500" (12,7mm) or larger.
- Screw-clamping integral toolholder.

Pages:
D116–D121



TopGroove

- NF/NFD face groove insert range: .94"–2.25" (24,0mm–57,0mm).
- Cutting width range for standard inserts: .079"–.156" (0,8mm–9,5mm).
- Cutting depth range for standard inserts: .070"–.500" (1,27mm–12,70mm).
- Cutting width range for NF/NFD face grooving inserts: .079"–.25" (2,0mm–6,35mm).
- Standard insert minimum face groove diameter range: 2.125"–13" (54,0mm–330,0mm).
- Cutting depth range for NF/NFD face grooving inserts: .060"–.500" (1,52mm–12,70mm).
- Cutting depth range for NF: .060"–.150" (1,52mm–3,81mm).
- Cutting depth range for NFD: .250"–.500" (6,35mm–12,7mm).

Pages:
D30–D71



Profiling

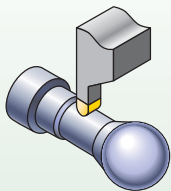

WMT

For Heavy Stock Removal

- Full radius insert cutting widths: .118"–.315" (3,0mm–8,0mm).
- OD cutting depths: .650"–1.0" (16,5mm–25,4mm)
- Screw-clamping integral shank/cartridge toolholders available.

Pages:
D4–D29



TopGroove

Moderate/Heavy Stock Removal at Shallow Profile Depths

- Full-radius insert cutting widths: .062"–.250" (1,57mm–6,35mm).
- Insert cutting depths: .094"–.250" (2,39mm–6,35mm).
- Integral shank toolholders and Erickson™ heads available.

Pages:
D30–D71



ProGroove

For Light Cutting

- Full-radius insert cutting widths: .118"–.236" (3,0mm–6,0mm).
- OD cutting depths: .394"–1.26" (10,0mm–32,0mm).
- Screw-clamping integral shank/cartridge toolholders available.

Pages:
D72–D84



Undercutting

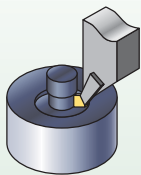

TopGroove

- Undercutting insert widths: .094"–.157" (2,4mm–4,0mm).
- Economical double-ended inserts.

Pages:
D30–D71



WMT™ System

One System for Grooving, Cut-Off, Turning, and Profiling.

The WIDIA™ line of WMT Toolholders is the economical and reliable option for all your grooving, cut-off, turning, and profiling applications. Trust the WMT system to ensure precise insert positioning and provide only the most accurate machining with exceptionally fast cycle times and superior performance.

Versatile and Well Constructed

- Specifically designed to increase speeds and feeds.
- Excellent geometry for even your most demanding deep grooving applications.
- The WMT system enables heavy stock removal in turning applications.
- Ensures finer surface finishes and a long, reliable tool life.

WMT Toolholders

- Outstanding system rigidity and clamping capabilities.
- Guarantees fast cycles times and limited turret indexes.
- Precise insert positioning for accurate machining.
- Double-V shape means operator-friendly insert indexing and optimum insert positioning.



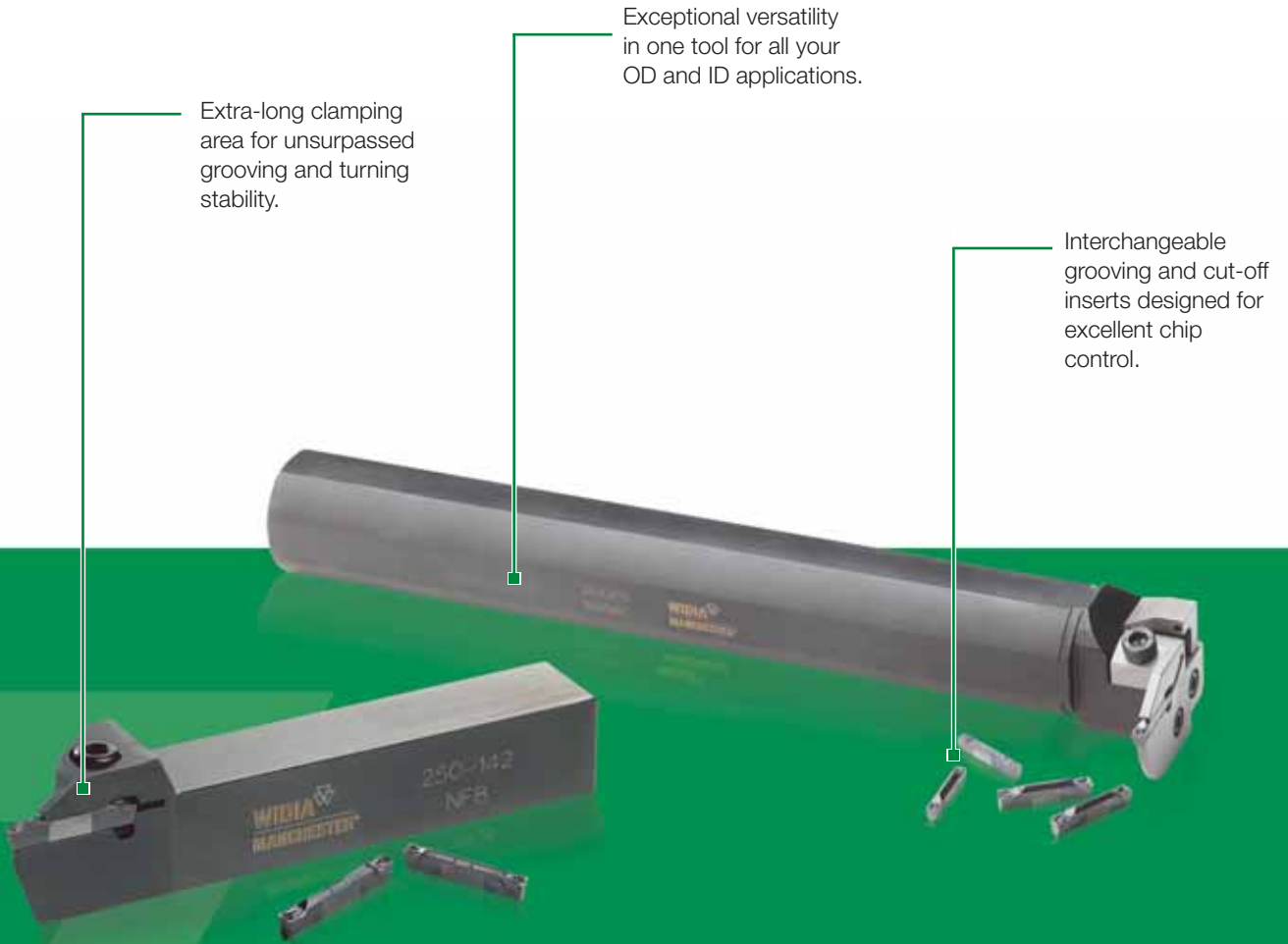

WMT™ SLS



- Integral and modular Serrated Locking System (SLS) accepts SX, SX Ultra, and PT/PC inserts.
- Replaceable cartridge makes changing applications quick and easy.
- Adaptable and easy to use, it reduces setup time and downtime between jobs.
- A variety of insert widths available to meet your specific needs.

Choosing the Correct WMT™ Cutter

Grooving, Cut-Off, Turning, and Profiling

The Most Advanced Turning Solutions in the Industry

For unsurpassed quality, value, and performance, look no further than the WIDIA™ comprehensive line of specially engineered and dependable grooving and cut-off solutions. All the tools you need from the reliable name you can trust!

The WMT system, with its extra-long clamping area and precise insert positioning, ensures exceptionally fast and accurate machining, all-in-one tool, for your most demanding grooving, cut-off, turning, and profiling applications.

It is perfect for all general purpose operations, including both shallow and deep grooving.

Utilize this handy, easy-to-use guide to identify and select the appropriate grooving and cut-off tools for your specific needs.

1 Choose the application to be performed:

Groove depth, width, and profile.

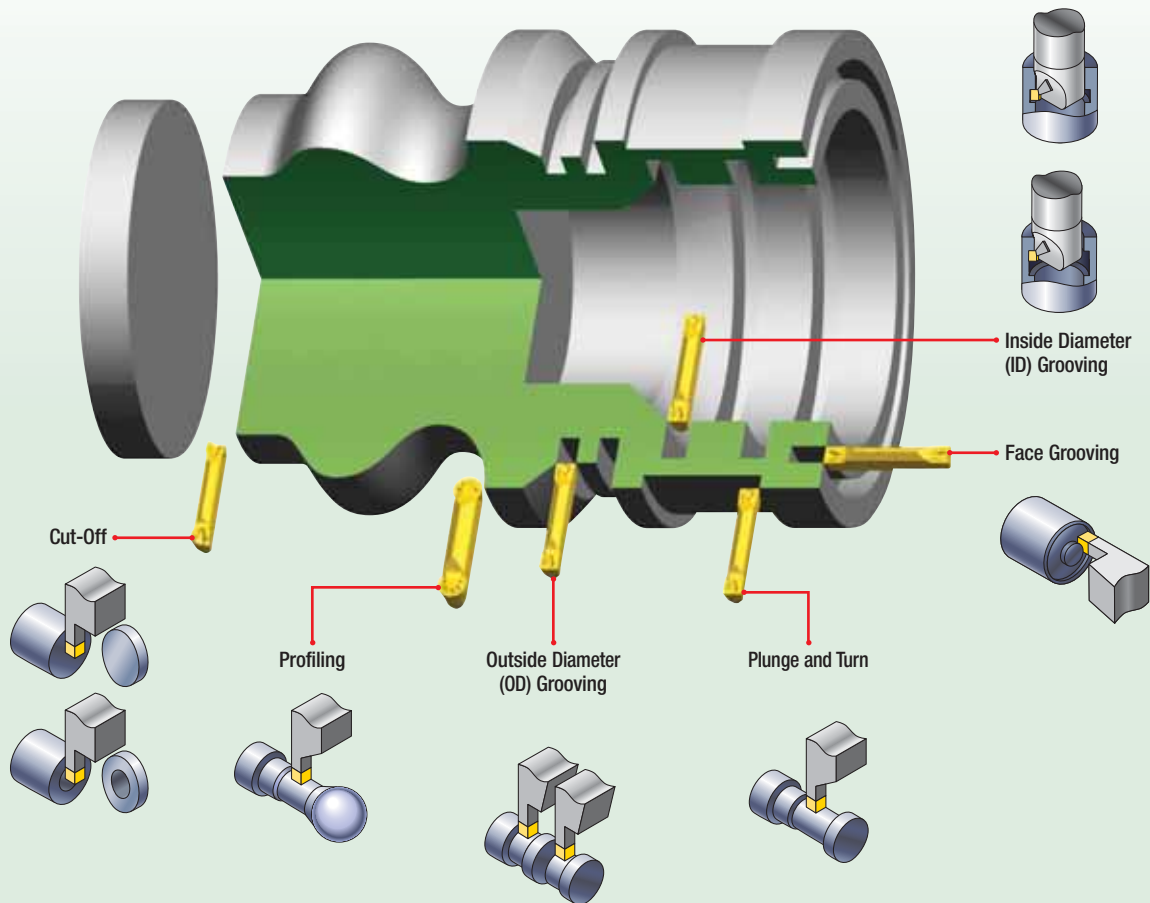

2 Identify the material to be machined:

Each tool has a material grid marked with a letter indicating the materials that can be machined.

P	Steel
M	Stainless Steel
K	Cast Iron
N	Non-Ferrous Materials
S	High-Temp Alloys
H	Hardened Materials

3 Select your toolholder based on the application:

- A Choose the appropriate width “W” required for the application.
- B Choose the shortest cutting depth “CD” dimension for increased tool rigidity.
- C Select the largest toolholder shank “H” and “B” dimensions for maximum rigidity.

WMT Grooving, Cut-Off, and Turning
Integral Toolholders

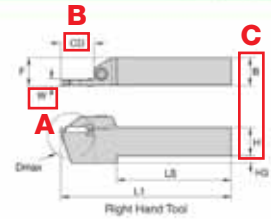
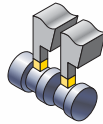

■ OD Grooving

order number	catalog number	A		D max	F	C		HG	L1	L2	clamp screw
		W	CD			H	B				
3655137	250319	.059	.850	—	.991	1.000	1.000	—	8.000	4.679	606266
3655938	250321	.079	—	1.062	.375	.375	.369	.125	4.500	3.500	606249
3655940	250323	.079	—	1.125	.500	.500	.494	.188	4.500	3.500	606249
3655942	250326	.079	.850	—	.625	.625	.603	.250	5.000	4.000	606249
3655944	250327	.079	.850	—	.750	.750	.719	—	5.000	3.687	606249
3655946	250329	.079	.850	—	1.000	1.000	.969	—	6.000	4.660	606249
3655968	250109	.094	—	1.062	.375	.375	.365	.125	4.500	3.500	606249
3655992	250111	.094	—	1.250	.500	.500	.490	.190	4.500	3.290	606249
3655994	250113	.094	.750	—	.625	.625	.603	.250	5.000	3.480	619205
3655996	250115	.094	.750	—	.750	.750	.719	.250	5.000	3.480	619205
3655934	250188	.094	.420	—	.750	.750	.719	—	5.000	3.695	619205
3655936	250193	.094	.750	—	.990	1.000	.969	—	6.000	4.300	619205
3655938	250117	.125	.440	—	.625	.625	.603	—	5.000	3.695	619205
3655900	250119	.125	.875	—	.625	.625	.603	.250	5.000	3.355	619205
3655906	250127	.125	.440	—	.750	.750	.719	—	5.000	3.695	619205
3655908	250129	.125	.875	—	.750	.750	.719	.250	5.000	3.355	619205
3655916	250141	.125	.440	—	1.000	1.000	.969	—	6.000	4.695	619205
3655918	250143	.125	.875	—	1.000	1.000	.969	—	6.000	4.375	619205
3655920	250145	.156	.875	—	1.000	1.000	.969	—	6.000	4.375	619205
3655930	250181	.156	.440	—	.625	.625	.603	—	5.000	3.695	619205
3655932	250183	.156	.440	—	.750	.750	.719	—	5.000	3.695	619205
3655902	250123	.188	.560	—	.629	.625	.603	—	5.000	3.562	619168
3655904	250125	.188	1.000	—	.679	.625	.603	.250	5.000	3.655	619168
3655910	250133	.188	.560	—	.750	.750	.719	—	5.000	3.562	619168
3655912	250135	.188	1.000	—	.750	.750	.719	.250	5.000	3.655	619168
3655922	250147	.188	.560	—	1.000	1.000	.969	—	6.000	4.562	619168
3655924	250149	.188	1.000	—	1.000	1.000	.969	—	6.000	4.175	619168
3655914	250137	.250	.560	—	.754	.750	.719	—	5.000	3.562	619168
3655926	250151	.250	.560	—	1.004	1.000	.969	—	6.000	4.562	619168
3655928	250153	.250	1.000	—	1.002	1.000	.969	—	6.000	4.174	619168
3639143	250175	.312	.560	—	1.250	1.250	1.207	—	6.000	4.553	619168
3639145	250177	.312	1.000	—	—	1.250	1.207	—	6.000	4.174	619168

	application	conventional toolholders	modular blades
	OD Grooving and Cut-Off	pages D10–D12	pages D16–D17
	Face Grooving	pages D13–D14	pages D18–D19
	ID Grooving	—	pages D20–D21
	Plunge and Turn	pages D10–D12	pages D16–D17

4 Select chipbreaker style for the application:

- SX-Ultra (1st choice) Cut-off
- SX Cut-off with wipers
- PT Grooving and turning
- PC Profiling and turning

NOTE: Chart shows recommended starting feed rates.

See page D22.

WMT™ Inserts Feed Values for Grooving

SX Cut-Off Inserts

- Wear flats where surface finish is critical.
- Double-ended, V-bottom, and top, mechanically clamped.
- Neutral, right-, and left-hand lead angles up to 12°.
- Designed to increase speed and feed.
- Chip geometry designed for excellent chip control and minimized cutting pressure on various materials.

SX-Ultra Cut-Off Inserts

- Double-ended, V-bottom, and top, mechanically clamped.
- Neutral, right-, and left-hand lead angles up to 12°.
- Designed to increase speed and feed.
- Chip geometry designed for excellent chip control and minimized cutting pressure on various materials.
- Ideal for 300 Series stainless steel, tool steel, titanium, INCONEL™, and other nickel-based alloys at moderate speeds and feeds.

PT Grooving Inserts

- High positive rake geometry for low cutting force, especially in soft materials.
- Deep-grooving tool for plunge and turn OD and face grooving operations.
- Delivers chip control over full range of DOC when turning.
- Cuts in both axial and radial direction.

PC Grooving and Profiling Inserts

- Superior chip control.
- Full nose radius geometry for plunge and contour operations.
- Effective cutting edge geometry exceeds 150° for increased versatility.

D22 WWW.WIDIA.COM

- A Choose the appropriate insert width "W" for your specific application.
- B Select the required corner radius value "RR".

WMT™ Grooving, Cut-Off, and Turning





Groove and Turn, Plunge and Contour Inserts

- first choice
- alternate choice

catalog number	W		RR		L1		hand	TiAlN	TiAlN	TiAlN
	mm	in	mm	in	mm	in				
982125	2.30	.091	0.13	.006	22.15	.872	N - Neutral	●	●	●
982126	2.36	.094	0.38	.015	22.15	.872	N - Neutral	●	●	●
982101	3.18	.125	0.23	.009	25.40	1.000	N - Neutral	●	●	●
982102	3.18	.125	0.76	.030	25.40	1.000	N - Neutral	●	●	●
982103	3.80	.150	0.25	.010	25.40	1.000	N - Neutral	●	●	●
982104	3.80	.150	0.76	.030	25.40	1.000	N - Neutral	●	●	●
982105	4.78	.188	0.25	.010	28.83	1.127	N - Neutral	●	●	●
982106	4.78	.188	0.76	.030	28.83	1.127	N - Neutral	●	●	●

D8 WWW.WIDIA.COM

5 Select grade:

cutting condition		Recommended Grades					
		steel	stainless steel	cast iron	non-ferrous metals	high-temp alloys	hardened materials
smooth cut, pre-turned surface		TN6016	TN6026	TN6016	TN6016	TN6026	TN6026
varying depth of cut, casting, or forging skin		TN6016	TN6026	TN6016	TN6016	TN6026	TN6026
lightly interrupted cut		TN6031	TN6026	TN6031	TN6031	TN6026	TN6026
heavily interrupted cut		TN6031	TN6026	TN6031	TN6031	TN6026	TN6026

See page D23 for Grades and Grade Descriptions.

6 Determine cutting data:

- A Based on material group and grade, identify starting speed (vc).
- B First choice starting speed is in **bold**.

See page D24 for cutting data.

ANSI ISO 513		VDI 3323		WMT™ Grooving, Cut-Off, and Turning Recommended Cutting Speed Starting Conditions											
Material Group		Cutting Speed • vc SFM													
		TN6016 (M83)			TN6031 (M43)			TN6026 (M433B)							
		min	Start	max	min	Start	max	min	Start	max	min	Start	max		
P	1	350	650	750	440	540	640	395	495	595					
	2	350	650	750	405	595	695	445	545	645					
	3	450	550	650	405	505	605	365	465	565					
	4	500	600	700	450	500	600	405	505	605					
	5	450	550	650	405	505	605	365	465	565					
	6	450	550	650	405	505	605	365	465	565					
	7	540	640	740	485	585	685	435	535	635					
	8	450	550	650	405	505	605	365	465	565					
	9	450	550	650	405	505	605	365	465	565					
	10	475	575	675	430	530	630	385	485	585					
	11	400	500	600	360	460	560	325	425	525					
	12	450	550	650	405	505	605	365	465	565					
	13.1	450	550	650	405	505	605	365	465	565					
13.2	400	500	600	360	460	560	325	425	525						
M	14.1	350	450	550	315	415	515	265	365	465					
	14.2	280	380	480	250	350	450	225	325	425					
	14.3	275	325	425	205	305	405	180	280	380					
	14.4	175	275	375	160	260	360	140	240	340					
K	15	600	700	800	540	640	740	485	585	685					
	16	450	550	650	405	505	605	365	465	565					
	17	500	600	700	450	550	650	405	505	605					
	18	475	575	675	430	530	630	385	485	585					
	19	650	750	850	585	685	785	525	625	725					
	20	450	550	650	405	505	605	365	465	565					
N	21	1000	1100	1200	900	1000	1100								
	22	800	900	1000	720	820	920								
	23	1000	1100	1200	900	1000	1100								
	24	800	900	1000	720	820	920								
	25	700	800	900	630	730	830								
	26	500	600	700	450	550	650								
	27	500	600	700	450	550	650								
	28	500	600	700	450	550	650								
	29	450	550	650	405	505	605								
	30	450	550	650	405	505	605								
S	31	170	270	370	155	255	355	140	240	340					
	32	120	220	320	110	210	310	95	195	295					
	33	125	225	325	115	215	315	100	200	300					
	34	100	200	300	90	190	290	80	180	280					
	35	110	210	310	100	200	300	90	190	290					
	36	220	320	420	200	300	400	180	280	380					
	37	125	225	325	115	215	315	100	200	300					

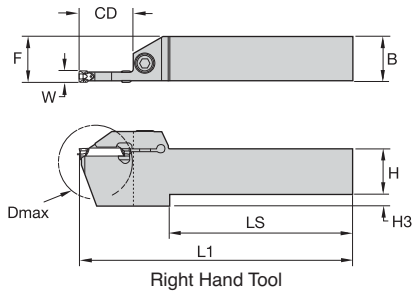

Right Hand Tool

■ OD Grooving and Cut-Off

order number	catalog number	H	W	CD	D max	F	B	H3	L1	LS	clamp screw
	Right hand										
3655938	250301	.375	.079	—	1.062	.375	.369	.125	4.500	3.410	606249
3655888	250109	.375	.094	—	1.062	.375	.365	.125	4.500	3.410	606249
3655940	250303	.500	.079	—	1.125	.500	.494	.188	4.500	3.410	606249
3655892	250111	.500	.094	—	1.250	.500	.490	.190	4.500	3.290	606249
3655942	250305	.625	.079	.650	—	.625	.603	.250	5.000	3.680	606249
3655894	250113	.625	.094	.750	—	.625	.603	.250	5.000	3.480	619205
3655898	250117	.625	.125	.440	—	.625	.603	—	5.000	3.695	619205
3655900	250119	.625	.125	.875	—	.625	.603	.250	5.000	3.355	619205
3655930	250181	.625	.156	.440	—	.625	.603	—	5.000	3.695	619205
3655902	250123	.625	.188	.560	—	.629	.603	—	5.000	3.562	619168
3655904	250125	.625	.188	1.000	—	.629	.603	.250	5.500	3.655	619168
3655944	250307	.750	.079	.650	—	.750	.719	—	5.000	3.680	606249
3655896	250115	.750	.094	.750	—	.750	.719	.250	5.000	3.480	619205
3655934	250189	.750	.094	.420	—	.750	.719	—	5.000	3.695	619205
3655906	250127	.750	.125	.440	—	.750	.719	—	5.000	3.695	619205
3655908	250129	.750	.125	.875	—	.750	.719	.250	5.000	3.355	619205
3655932	250183	.750	.156	.440	—	.750	.719	—	5.000	3.695	619205
3655910	250133	.750	.188	.560	—	.750	.719	—	5.000	3.562	619168
3655912	250135	.750	.188	1.000	—	.750	.719	.250	5.500	3.655	619168
3655914	250137	.750	.250	.560	—	.754	.719	—	5.000	3.562	619168
3656137	250319	1.000	.059	.650	—	.991	1.000	—	6.000	4.679	606266
3655946	250309	1.000	.079	.650	—	1.000	.969	—	6.000	4.680	606249
3655936	250193	1.000	.094	.750	—	.990	.969	—	6.000	4.500	619205
3655916	250141	1.000	.125	.440	—	1.000	.969	—	6.000	4.695	619205
3655918	250143	1.000	.125	.875	—	1.000	.969	—	6.000	4.375	619205
3655920	250145	1.000	.156	.875	—	1.000	.969	—	6.000	4.375	619205
3655922	250147	1.000	.188	.560	—	1.000	.969	—	6.000	4.562	619168
3655924	250149	1.000	.188	1.000	—	1.000	.969	—	6.000	4.175	619168
3655926	250151	1.000	.250	.560	—	1.004	.969	—	6.000	4.562	619168
3655928	250153	1.000	.250	1.000	—	1.002	.969	—	6.000	4.174	619168
3539143	250175	1.250	.312	.560	—	1.250	1.207	—	6.000	4.553	619168
3539145	250177	1.250	.312	1.000	—	—	1.207	—	6.000	4.174	619168

(continued)

(continued)

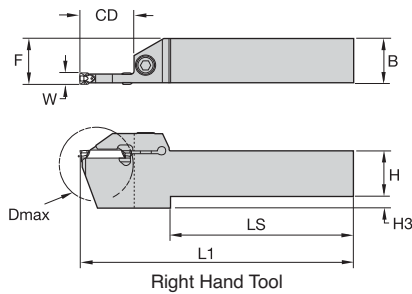

■ OD Grooving and Cut-Off

order number	catalog number	H	W	CD	D max	F	B	H3	L1	LS	clamp screw
Left hand											
3655939	250302	.375	.079	—	1.062	.375	.369	.125	4.500	3.410	606249
3655889	250110	.375	.094	—	1.062	.375	.365	.125	4.500	3.410	606249
3655941	250304	.500	.079	—	1.125	.500	.494	.188	4.500	3.410	606249
3655893	250112	.500	.094	—	1.250	.500	.490	.190	4.500	3.290	606249
3655943	250306	.625	.079	.650	—	.625	.603	.250	5.000	3.680	606249
3655895	250114	.625	.094	.750	—	.625	.603	.250	5.000	3.480	619205
3655899	250118	.625	.125	.440	—	.625	.603	—	5.000	3.695	619205
3655901	250120	.625	.125	.875	—	.625	.603	.250	5.000	3.355	619205
3655931	250182	.625	.156	.440	—	.625	.603	—	5.000	3.695	619205
3655903	250124	.625	.188	.560	—	.629	.603	—	5.000	3.562	619168
3655905	250126	.625	.188	1.000	—	.629	.603	.250	5.500	3.655	619168
3655945	250308	.750	.079	.650	—	.750	.719	—	5.000	3.680	606249
3655897	250116	.750	.094	.750	—	.750	.719	.250	5.000	3.480	619205
3655935	250190	.750	.094	.420	—	.750	.719	—	5.000	3.695	619205
3655907	250128	.750	.125	.440	—	.750	.719	—	5.000	3.695	619205
3655909	250130	.750	.125	.875	—	.750	.719	.250	5.000	3.355	619205
3655933	250184	.750	.156	.440	—	.750	.719	—	5.000	3.697	619205
3655911	250134	.750	.188	.560	—	.750	.719	—	5.000	3.562	619168
3655913	250136	.750	.188	1.000	—	.750	.719	.250	5.500	3.655	619168
3655915	250138	.750	.250	.560	—	.754	.719	—	5.000	3.562	619168
3656138	250320	1.000	.059	.650	—	.991	1.000	—	6.000	4.679	606249
3655947	250310	1.000	.079	.650	—	1.000	.969	—	6.000	4.680	606249
3655937	250194	1.000	.094	.750	—	1.000	.969	—	6.000	4.500	619205
3655917	250142	1.000	.125	.440	—	1.000	.969	—	6.000	4.695	619205
3655919	250144	1.000	.125	.875	—	1.000	.969	—	6.000	4.375	619205
3655921	250146	1.000	.156	.875	—	1.000	.969	—	6.000	4.375	619205
3655923	250148	1.000	.188	.560	—	1.000	.969	—	6.000	4.562	619168
3655925	250150	1.000	.188	1.000	—	1.000	.969	—	6.000	4.175	619168
3655927	250152	1.000	.250	.560	—	1.004	.969	—	6.000	4.562	619168
3655929	250154	1.000	.250	1.000	—	1.004	.969	—	6.000	4.174	619168
3539144	250176	1.250	.312	.560	—	1.250	1.207	—	6.000	4.553	619168
3539146	250178	1.250	.312	1.000	—	—	1.2070	—	6.000	4.174	619168

WMT™ Grooving, Cut-Off, and Turning

Integral Toolholders for Swiss-Style Machines

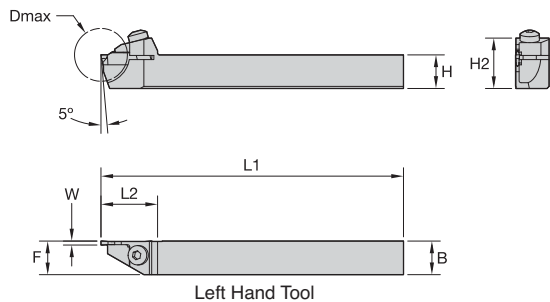

Left Hand Tool

■ Swiss Grooving and Cut-Off

order number	catalog number	W	D max	B	H	H2	F	L1	L2	clamp screw
Right hand										
3655948	250311	.059	.787	.375	.375	.625	.375	4.500	.842	606249
3655949	250313	.059	.787	.500	.500	.750	.500	4.500	.842	606249
3656133	250315	.059	1.024	.625	.625	.925	.626	5.000	.952	606266
3656135	250317	.059	1.024	.750	.750	1.050	.750	5.000	.952	606266
3656139	250321	.079	.787	.375	.375	.625	.375	4.500	.843	606249
3656141	250323	.079	.787	.500	.500	.750	.500	4.500	.843	606249
3656143	250325	.079	1.024	.625	.625	.925	.625	5.000	.953	606266
3656145	250327	.079	1.024	.750	.750	1.050	.750	5.000	.953	606266
Left hand										
3656186	250312	.059	.787	.375	.375	.625	.375	4.500	.842	606249
3656101	250314	.059	.787	.500	.500	.750	.500	4.500	.842	606249
3656134	250316	.059	1.024	.625	.625	.925	.626	5.000	.952	606266
3656136	250318	.059	1.024	.750	.750	1.050	.750	5.000	.952	606266
3656140	250322	.079	.787	.375	.375	.625	.375	4.500	.843	606249
3656142	250324	.079	.787	.500	.500	.750	.500	4.500	.843	606249
3656144	250326	.079	1.024	.625	.625	.925	.625	5.000	.953	606266
3656146	250328	.079	1.024	.750	.750	1.050	.750	5.000	.953	606266

NOTE: Insert exterior edge in line with toolholder edge for .375" and .500" shank toolholders.

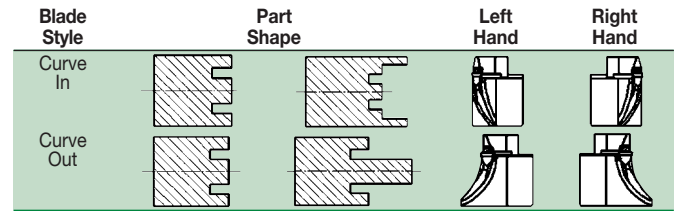
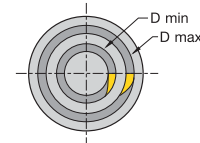
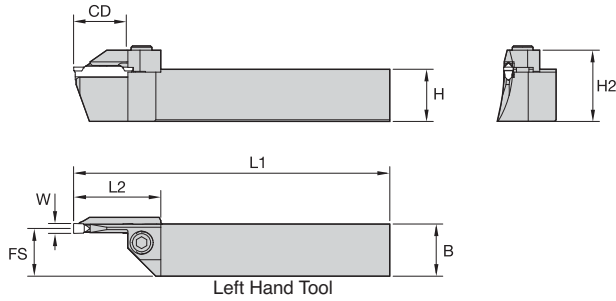

■ **Curve Out**

order number	catalog number	W	CD	D max	D min	FS	H2	H	B	L1	L2	clamp	clamp screw
Right hand													
3656147	251117	.125	.500	2.000	1.500	.937	1.280	.990	.990	6.000	1.343	—	619205
3656149	251119	.125	.625	2.750	2.000	.937	1.280	.990	.990	6.000	1.343	—	619205
3656151	251121	.125	.625	4.000	2.750	.937	1.280	.990	.990	6.000	1.343	—	619205
3656153	251123	.125	.750	8.000	4.000	.937	1.280	.990	.990	6.000	1.438	—	619205
3656155	251133	.188	.625	2.000	1.500	.906	1.355	.990	.990	6.000	1.500	446102	619168
3656157	251135	.188	.750	2.750	2.000	.906	1.352	.990	.990	6.000	1.500	446102	619168
3656159	251137	.188	.750	4.000	2.750	.906	1.352	.990	.990	6.000	1.655	446104	619168
3656161	251139	.188	1.000	8.000	4.000	.906	1.352	.990	.990	6.000	1.655	446104	619168
3656163	251149	.250	.625	2.000	1.500	.877	1.377	.990	.990	6.000	1.500	446102	619168
3656165	251151	.250	.750	2.750	2.000	.875	1.372	.990	.990	6.000	1.500	446102	619168
3656168	251155	.250	1.000	8.000	4.000	.875	1.372	.990	.990	6.000	1.655	446104	619168
3656187	251153	.251	.750	4.000	2.750	.875	1.372	.990	.990	6.000	1.655	446104	619168
Left hand													
3656148	251118	.125	.500	2.000	1.500	.937	1.280	.990	.990	6.000	1.343	—	619205
3656152	251122	.125	.625	4.000	2.750	.937	1.280	.990	.990	6.000	1.343	—	619205
3656150	251120	.125	.625	2.750	2.000	.937	1.280	.990	.990	6.000	1.343	—	619205
3656154	251124	.125	.750	8.000	4.000	.937	1.280	.990	.990	6.000	1.438	—	619205
3656156	251134	.188	.625	2.000	1.500	.906	1.355	.990	.990	6.000	1.500	446101	619168
3656160	251138	.188	.750	4.000	2.750	.906	1.352	.990	.990	6.000	1.655	446103	619168
3656158	251136	.188	.750	2.750	2.000	.906	1.352	.990	.990	6.000	1.500	446101	619168
3656162	251140	.188	1.000	8.000	4.000	.906	1.352	.990	.990	6.000	1.655	446103	619168
3656164	251150	.250	.625	2.000	1.500	.875	1.377	.990	.990	6.000	1.500	446101	619168
3656166	251152	.250	.750	2.750	2.000	.875	1.372	.990	.990	6.000	1.500	446101	619168
3656167	251154	.250	.750	4.000	2.750	.875	1.372	.990	.990	6.000	1.655	446103	619168
3656169	251156	.250	1.000	8.000	4.000	.875	1.372	.990	.990	6.000	1.655	446103	619168

NOTE: Insert cutting edge for WMT Face Grooving system is positioned +.030" above center.
 The WMT Face Grooving system is not designed to cut diameters of less than .850".
 Toolholders that accept .125" width inserts have an integral clamp.
 Toolholders that accept .187" and .250" width inserts are supplied with a detachable clamp.

WMT™ Grooving, Cut-Off, and Turning

Integral Toolholders for Face Grooving

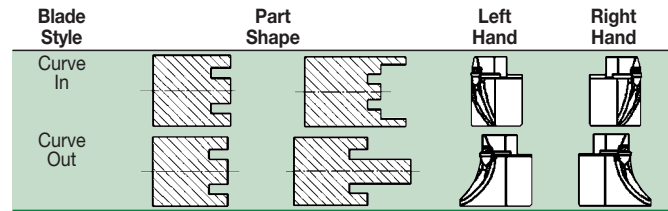
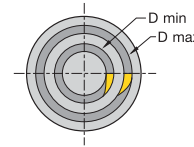
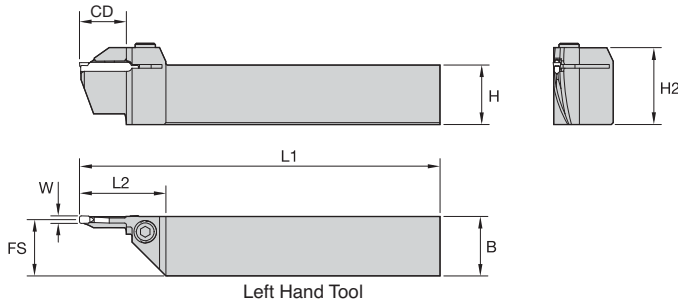

■ Curve In

order number	catalog number	W	CD	D max	D min	B	H	H2	FS	L1	L2	clamp	clamp screw
Right hand													
3539321	252109	.125	.625	4.000	2.750	.990	.990	1.280	.937	6.000	1.343	—	MS326
3539323	252111	.125	.750	8.000	4.000	.990	.990	1.280	.937	6.000	1.438	—	MS326
3539325	252117	.187	.750	4.000	2.750	.990	.990	1.336	.906	6.000	1.655	446104	619168
3539327	252119	.187	1.000	8.000	4.000	.990	.990	1.336	.906	6.000	1.655	446104	619168
3539329	252125	.250	.765	4.000	2.750	.990	.990	1.336	.875	6.000	1.655	446104	619168
3539331	252127	.250	1.000	8.000	4.000	.990	.990	1.336	.875	6.000	1.655	446104	619168
Left hand													
3539322	252110	.125	.625	4.000	2.750	.990	.990	1.280	.937	6.000	1.343	—	MS326
3539324	252112	.125	.750	8.000	4.000	.990	.990	1.280	.937	6.000	1.438	—	MS326
3539326	252118	.187	.750	4.000	2.750	.990	.990	1.336	.906	6.000	1.655	446103	619168
3539328	252120	.187	1.000	8.000	4.000	.990	.990	1.336	.906	6.000	1.655	446103	619168
3539330	252126	.250	.765	4.000	2.750	.990	.990	1.336	.875	6.000	1.655	446103	619168
3539332	252128	.250	1.000	8.000	4.000	.990	.990	1.336	.875	6.000	1.655	446103	619168

NOTE: Insert cutting edge for WMT Face Grooving system is positioned $+.030''$ above center.
 The WMT Face Grooving system is not designed to cut diameters of less than $.850''$.
 Toolholders that accept $.125''$ width inserts have an integral clamp.
 Toolholders that accept $.187''$ and $.250''$ width inserts are supplied with a detachable clamp.

WIN WITH WIDIA™

WIDIA 



WMT™ System

The WIDIA WMT System is the economical and reliable option for all of your grooving, cut-off, turning, and profiling applications. Trust the WMT system to ensure precise insert positioning and provide only the most accurate machining with exceptionally fast cycle times and superior performance.

WMT Toolholders

- Guarantees fast cycle times and limited turret indexes.
- Precise insert positioning for accurate machining.

WMT SLS

- A variety of insert widths available to meet your specific needs.
- Integral and modular Serrated Locking System (SLS) accepts SX, SX Ultra, and PT/PC inserts.

To learn more, contact your local Authorized Distributor or visit www.widia.com.

WIDIA 
Win with WIDIA™

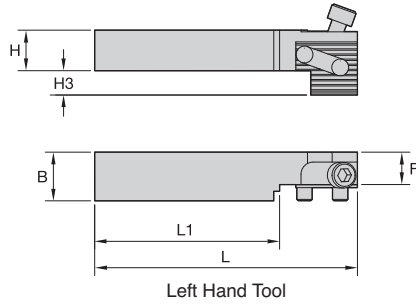

■ Grooving, Cut-Off, and Face Grooving

order number	catalog number	H	B	L	L1	F	H3	cartridge screw
Right hand								
3656170	253101	.625	.750	4.050	2.850	.547	.375	606255
3656172	253103	.750	.750	4.050	2.850	.547	.250	606255
3656176	253107	1.000	1.000	5.050	3.850	.797	—	619419
3656174	253105	1.250	1.250	5.050	3.850	1.047	—	619419
Left hand								
3656171	253102	.625	.750	4.050	2.850	.547	.375	606255
3656173	253104	.750	.750	4.050	2.850	.547	.250	606255
3656177	253108	1.000	1.000	5.050	3.850	.797	—	619419
3656175	253106	1.250	1.250	5.050	3.850	1.047	—	619168

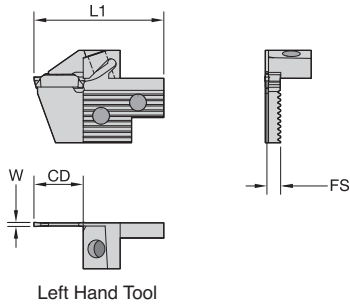

■ Grooving and Cut-Off

order number	catalog number	W	CD	L1	FS
Right hand					
3653461	348101	.059	.650	1.934	.204
3653463	348103	.079	.650	1.932	.195
3653465	348105	.094	.752	2.050	.185
3653467	348107	.118	.874	2.150	.175
3653469	348109	.158	.874	2.150	.187
3653703	348111	.188	1.000	2.250	.170
3653705	348113	.250	1.000	2.250	.159
Left hand					
3653462	348102	.059	.650	1.934	.204
3653464	348104	.079	.650	1.932	.195
3653466	348106	.094	.752	2.050	.185
3653468	348108	.118	.874	2.150	.175
3653470	348110	.158	.874	2.150	.187
3653704	348112	.188	1.000	2.250	.170
3653706	348114	.250	1.000	2.250	.159

NOTE: Widths of .156", .187", and .250" are not recommended for .625" shank toolholders.
Width of .250" is not recommended for .750" shank toolholders.

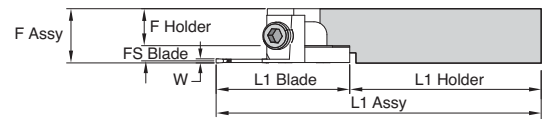
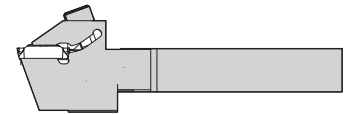

$$L1 \text{ Assy} = L1 \text{ (holder)} + L1 \text{ (blade)}$$

$$F \text{ Assy} = F \text{ (holder)} + FS \text{ (blade)} + W/2 + .031"$$

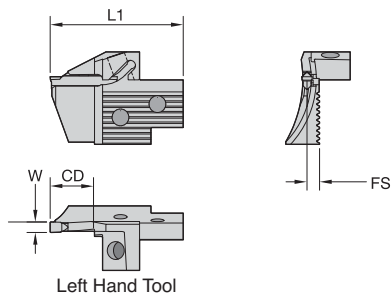

Left Hand Tool

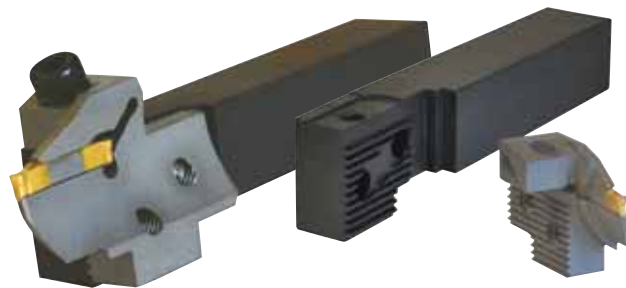

Right Hand Assembly

■ Face Grooving • Curve Out

order number	catalog number	W	D min	D max	CD	FS	L1
	Right hand						
3653707	349101	.125	1.500	2.000	.500	.174	1.980
3653708	349102	.125	2.000	2.750	.625	.175	1.980
3653709	349103	.125	2.750	4.000	.625	.175	1.980
3653710	349104	.125	4.000	8.000	.750	.175	2.075
3653715	349109	.156	1.500	2.000	.500	.187	1.980
3653716	349110	.156	2.000	2.750	.625	.187	1.980
3653717	349111	.156	2.750	4.000	.625	.187	1.980
3653718	349112	.156	4.000	8.000	.750	.187	2.075
3653723	349117	.187	1.500	2.000	.625	.170	2.074
3653724	349118	.187	2.000	2.750	.750	.170	2.074
3653725	349119	.187	2.750	4.000	.750	.170	2.230
3653726	349120	.187	4.000	8.000	1.000	.170	2.230
3653731	349125	.250	1.200	2.000	.625	.222	2.075
3653732	349126	.250	2.000	2.750	.750	.222	2.075
3653733	349127	.250	2.750	4.000	.750	.222	2.230
3653734	349128	.250	4.000	8.000	1.000	.222	2.230

NOTE: Width of .250" is not recommended for .750" shank toolholders.
See page D16 for shank tooling.

(continued)

(continued)

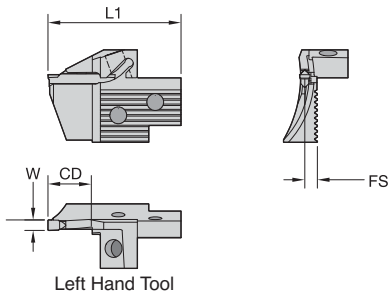

Left Hand Tool

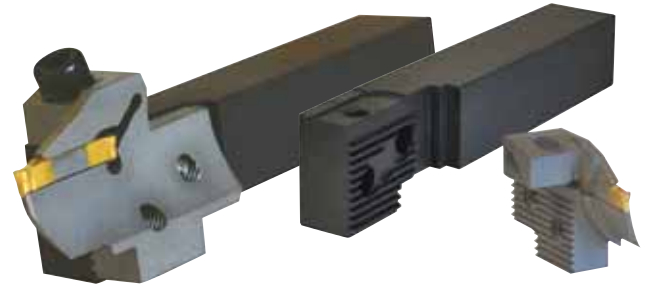

Right Hand Assembly

■ Face Grooving • Curve Out

order number	catalog number	W	D min	D max	CD	FS	L1
Left hand							
3653711	349105	.125	1.500	2.000	.500	.174	1.980
3653712	349106	.125	2.000	2.750	.625	.175	1.980
3653713	349107	.125	2.750	4.000	.625	.175	1.980
3653714	349108	.125	4.000	8.000	.750	.175	2.075
3653719	349113	.156	1.500	2.000	.500	.187	1.980
3653720	349114	.156	2.000	2.750	.625	.187	1.980
3653721	349115	.156	2.750	4.000	.625	.187	1.980
3653722	349116	.156	4.000	8.000	.750	.187	2.075
3653727	349121	.187	1.500	2.000	.625	.170	2.074
3653728	349122	.187	2.000	2.750	.750	.170	2.074
3653729	349123	.187	2.750	4.000	.750	.170	2.230
3653730	349124	.187	4.000	8.000	1.000	.170	2.230
3653735	349129	.250	1.200	2.000	.625	.222	2.075
3653736	349130	.250	2.000	2.750	.750	.222	2.075
3653737	349131	.250	2.750	4.000	.750	.222	2.230
3653738	349132	.250	4.000	8.000	1.000	.222	2.230

NOTE: Width of .250" is not recommended for .750" shank toolholders.
See page D16 for shank tooling.

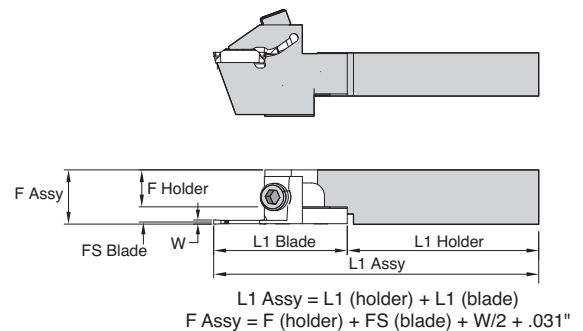
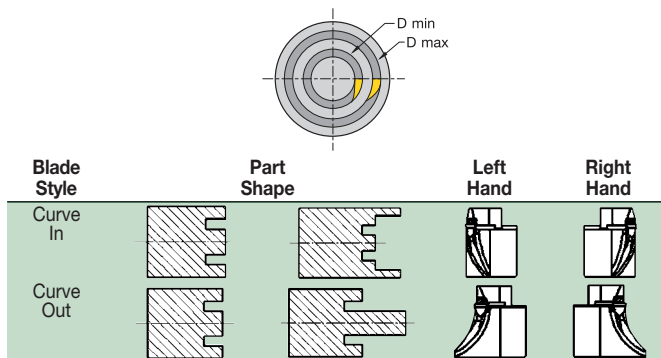

WMT™ Grooving, Cut-Off, and Turning

SLS Boring Bars

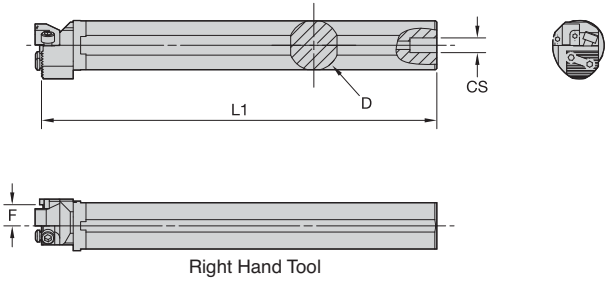

Left Hand Assembly

■ ID Grooving

order number	catalog number	D	F	L1	CS	coolant support screw	coolant spout	coolant support screw	clamp screw
Right hand									
3656178	254101	1.000	-0.630	7.766	1/4-18 NPT	606256	614125	619151	619168
3656180	254103	1.250	-0.630	9.766	1/4-18 NPT	606256	614125	619151	619168
3656182	254105	1.500	-0.630	11.766	1/4-18 NPT	606256	614125	619151	619168
3656184	254107	2.000	-0.512	11.766	1/4-18 NPT	606256	614125	619151	619168
Left hand									
3656179	254102	1.000	-0.630	7.766	1/4-18 NPT	606256	614126	619151	619168
3656181	254104	1.250	-0.630	9.766	1/4-18 NPT	606256	614126	619151	619168
3656183	254106	1.500	-0.630	11.766	1/4-18 NPT	606256	614126	619151	619168
3656185	254108	2.000	-0.512	11.766	1/4-18 NPT	606256	614126	619151	619168

NOTE: Right-hand holders use left-hand cartridges.

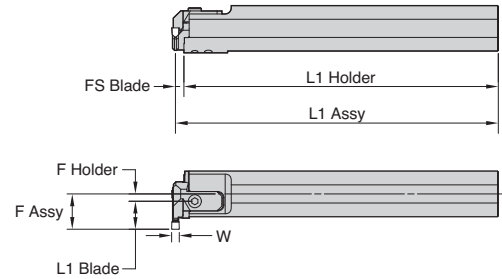

$$L1 \text{ Assy} = L1 \text{ (holder)} + FS \text{ (blade)} + W/2 + .031''$$

$$F \text{ Assy} = F \text{ (holder)} + L1 \text{ (blade)}$$

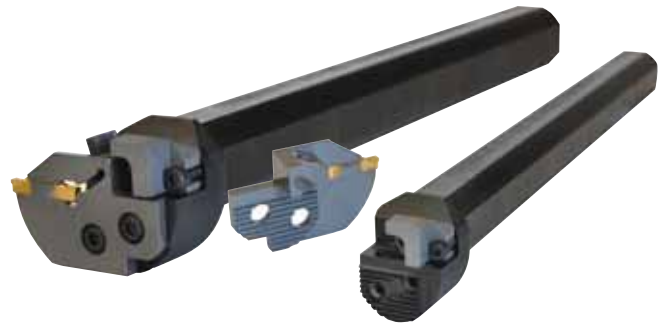
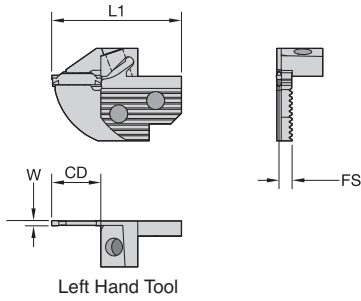

■ ID Grooving

order number	catalog number	W	CD	FS	L1
Right hand					
3653739	350103	.079	.500	.195	1.932
3653741	350105	.094	.625	.185	2.050
3653743	350107	.125	.750	.175	2.150
3653745	350109	.156	.750	.187	2.150
3653747	350111	.187	.850	.170	2.250
3653749	350113	.250	.850	.159	2.250
Left hand					
3653740	350104	.079	.500	.195	1.932
3653742	350106	.094	.625	.185	2.050
3653744	350108	.125	.750	.175	2.150
3653746	350110	.156	.750	.187	2.150
3653748	350112	.187	.850	.170	2.250
3653750	350114	.250	.850	.159	2.250

NOTE: Widths of .187" and .250" are not recommended for 1.000" shank toolholders.
Right-hand holders use left-hand cartridges.

SX Cut-Off Inserts



- Wiper flats where surface finish is critical.
- Double-ended, V-bottom, and top, mechanically clamped.
- Neutral, right-, and left-hand lead angles up to 12°.
- Designed to increase speed and feed.
- Chip geometry designed for excellent chip control and minimized cutting pressure on various materials.

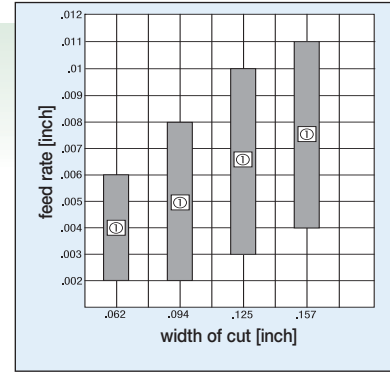

① Recommended feed

SX-Ultra Cut-Off Inserts

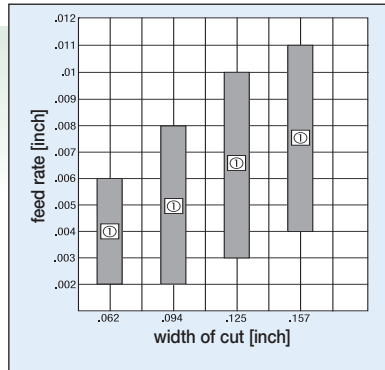

① Recommended feed

- Double-ended, V-bottom, and top, mechanically clamped.
- Neutral, right-, and left-hand lead angles up to 12°.
- Designed to increase speed and feed.
- Chip geometry designed for excellent chip control and minimized cutting pressure on various materials.
- Ideal for 300 Series stainless steel, tool steel, titanium, INCONEL®, and other nickel-based alloys at moderate speeds and feeds.

PT Grooving Inserts



- High positive rake geometry for low cutting force, especially in soft materials.
- Deep grooving tool for plunge and turn OD and face grooving operations.
- Delivers chip control over full range of DOC when turning.
- Cuts in both axial and radial direction.

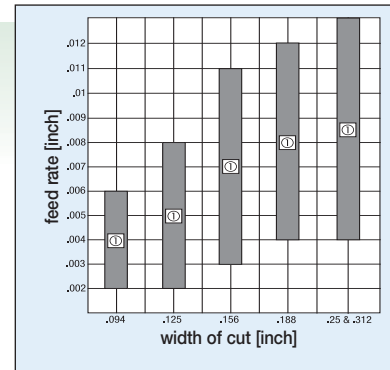

① Recommended feed

PC Grooving and Profiling Inserts

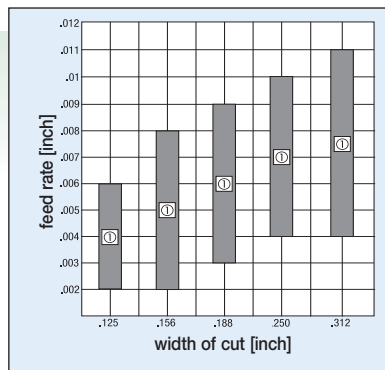

① Recommended feed

- Superior chip control.
- Full nose radius geometry for plunge and contour operations.
- Effective cutting edge geometry exceeds 180° for increased versatility.

Grooving, Cut-Off, and Turning • WMT

ANSI ISO 513	VDI 3323	Cutting Speed • vc SFM								
Material Group		min	Start	max	min	Start	max	min	Start	max
P	1 2 3 4 5 6 7 8 9 10 11 12 13.1 13.2	TN6016 (M93)			TN6031 (M43)			TN6026 (M433B)		
		550	650	750	440	540	640	395	495	595
		550	650	750	495	595	695	445	545	645
		450	550	650	405	505	605	365	465	565
		500	600	700	450	550	650	405	505	605
		450	550	650	405	505	605	365	465	565
		450	550	650	405	505	605	365	465	565
		540	640	740	485	585	685	435	535	635
		450	550	650	405	505	605	365	465	565
		450	550	650	405	505	605	365	465	565
		475	575	675	430	530	630	385	485	585
		400	500	600	360	460	560	325	425	525
		450	550	650	405	505	605	365	465	565
400	500	600	360	460	560	325	425	525		
M	14.1 14.2 14.3 14.4	TN6016 (M93)			TN6031 (M43)			TN6026 (M433B)		
		350	450	550	315	415	515	285	385	485
		280	380	480	250	350	450	225	325	425
		225	325	425	205	305	405	180	280	380
175	275	375	160	260	360	140	240	340		
K	15 16 17 18 19 20	TN6016 (M93)			TN6031 (M43)			TN6026 (M433B)		
		600	700	800	540	640	740	485	585	685
		450	550	650	405	505	605	365	465	565
		500	600	700	450	550	650	405	505	605
		475	575	675	430	530	630	385	485	585
		650	750	850	585	685	785	525	625	725
450	550	650	405	505	605	365	465	565		
N	21 22 23 24 25 26 27 28 29 30	TN6016 (M93)			TN6031 (M43)			TN6026 (M433B)		
		1000	1100	1200	900	1000	1100			
		800	900	1000	720	820	920			
		1000	1100	1200	900	1000	1100			
		800	900	1000	720	820	920			
		700	800	900	630	730	830			
		500	600	700	450	550	650			
		500	600	700	450	550	650			
		500	600	700	450	550	650			
		450	550	650	405	505	605			
450	550	650	405	505	605					
S	31 32 33 34 35 36 37	TN6016 (M93)			TN6031 (M43)			TN6026 (M433B)		
		170	270	370	155	255	355	140	240	340
		120	220	320	110	210	310	95	195	295
		125	225	325	115	215	315	100	200	300
		100	200	300	90	190	290	80	180	280
		110	210	310	100	200	300	90	190	290
		220	320	420	200	300	400	180	280	380
		125	225	325	115	215	315	100	200	300

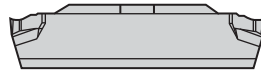
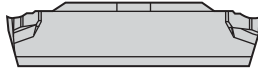
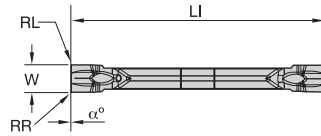
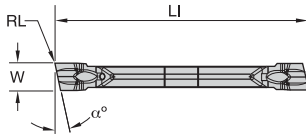

RR = RL

● first choice
○ alternate choice

P	●	○	○	○
M	●	○	○	○
K	●	○	○	○
N	●	○	○	○
S	●	○	○	○
H	●	○	○	○

■ WMT-SX

catalog number	W		RR		LI		α°	hand	TN6016	TN6026	TN6031
	mm	in	mm	in	mm	in					
583106	2,39	.094	0,13	.005	22,33	.879	—	N - Neutral	●	●	●
583111	3,18	.125	0,17	.007	25,44	1.000	—	N - Neutral	●	●	●

catalog number	W		RR		LI		α°	hand	TN6016	TN6026	TN6031
	mm	in	mm	in	mm	in					
583108	2,39	.094	0,13	.005	22,33	.879	5	L - Left	●	●	●
583110	2,39	.094	0,13	.005	22,38	.881	12	L - Left	●	●	●
583113	3,18	.125	0,17	.007	25,40	1.000	5	L - Left	●	●	●
583115	3,18	.125	0,17	.007	25,45	1.002	12	L - Left	●	●	●

catalog number	W		RL		LI		α°	hand	TN6016	TN6026	TN6031
	mm	in	mm	in	mm	in					
583107	2,39	.094	0,13	.005	22,33	.879	5	R - Right	●	●	●
583109	2,39	.094	0,13	.005	22,38	.881	12	R - Right	●	●	●
583112	3,18	.125	0,17	.007	25,40	1.000	5	R - Right	●	●	●
583114	3,18	.125	0,17	.007	25,45	1.002	12	R - Right	●	●	●

Grooving, Cut-Off, and Turning • Cut-Off Inserts

WMT™ Grooving, Cut-Off, and Turning

Cut-Off Inserts

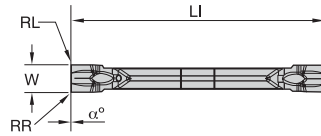
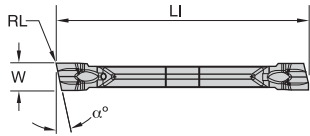

● first choice
○ alternate choice

P	●	○	●	○
M	●	○	●	○
K	●	○	●	○
N	●	○	●	○
S	●	○	●	○
H	●	○	●	○

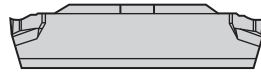
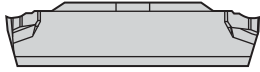

RR = RL

■ WMT-SX Ultra

catalog number	W		RR		LI		α°	hand	TN6016	TN6026	TN6031
	mm	in	mm	in	mm	in					
583140	2,39	.094	0,13	.005	22,33	.879	—	N - Neutral	●	○	○
583145	3,18	.125	0,17	.007	25,44	1.000	—	N - Neutral	●	○	○

catalog number	W		RR		LI		α°	hand	TN6016	TN6026	TN6031
	mm	in	mm	in	mm	in					
583142	2,39	.094	0,13	.005	22,33	.879	5	L - Left	●	○	○
583144	2,39	.094	0,13	.005	22,38	.881	12	L - Left	●	○	○
583147	3,18	.125	0,17	.007	25,40	1.000	5	L - Left	●	○	○
583149	3,18	.125	0,17	.007	25,45	1.002	12	L - Left	●	○	○

catalog number	W		RL		LI		α°	hand	TN6016	TN6026	TN6031
	mm	in	mm	in	mm	in					
583141	2,39	.094	0,13	.005	22,33	.879	5	R - Right	●	○	○
583143	2,39	.094	0,13	.005	22,38	.881	12	R - Right	●	○	○
583146	3,18	.125	0,17	.007	25,40	1.000	5	R - Right	●	○	○
583148	3,18	.125	0,17	.007	25,45	1.002	12	R - Right	●	○	○

Grooving, Cut-Off, and Turning • Cut-Off Inserts

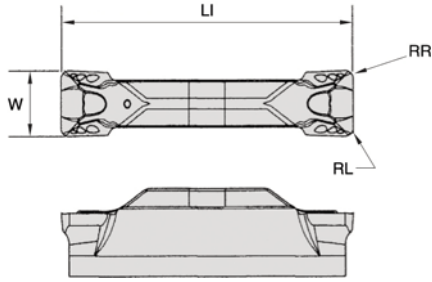

RR = RL

● first choice
○ alternate choice

P	■	○	●	●
M	■	○	●	●
K	■	○	●	●
N	■	○	●	○
S	■	○	●	○
H	■	○	●	○

■ WMT-PT

catalog number	W		RR		LI		hand	TN6016	TN6026	TN6031
	mm	in	mm	in	mm	in				
582125	2,39	.094	0,15	.006	22,15	.872	N - Neutral	●	●	●
582126	2,39	.094	0,38	.015	22,15	.872	N - Neutral	●	●	●
582101	3,18	.125	0,23	.009	25,40	1.000	N - Neutral	●	●	●
582102	3,18	.125	0,76	.030	25,40	1.000	N - Neutral	●	●	●
582103	3,96	.156	0,25	.010	25,40	1.000	N - Neutral	●	●	●
582104	3,96	.156	0,76	.030	25,40	1.000	N - Neutral	●	●	●
582105	4,78	.188	0,25	.010	28,63	1.127	N - Neutral	●	●	●
582106	4,78	.188	0,76	.030	28,63	1.127	N - Neutral	●	●	●
582107	6,35	.250	0,25	.010	28,63	1.127	N - Neutral	●	●	●
582108	6,35	.250	0,76	.030	28,63	1.127	N - Neutral	●	●	●
582110	7,93	.312	0,76	.030	28,58	1.125	N - Neutral	●	●	●
582148	7,93	.312	1,52	.060	28,58	1.125	N - Neutral	●	●	●

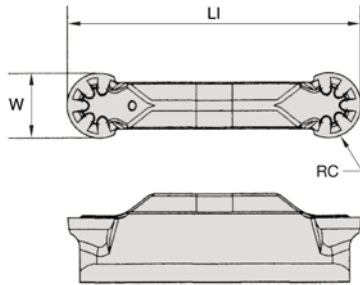

■ WMT-PC

catalog number	W		RC		LI		TN6016	TN6026	TN6031
	mm	in	mm	in	mm	in			
581101	3,18	.125	1,59	.063	25,55	1.006	●	●	●
581102	3,96	.156	1,98	.078	25,40	1.000	●	●	●
581103	4,78	.188	2,39	.094	28,65	1.128	●	●	●
581104	6,35	.250	3,18	.125	29,01	1.142	●	●	●
581105	7,93	.312	3,96	.156	29,01	1.142	●	●	●

Grooving, Cut-Off, and Turning • Grooving, Turning, Plunge, and Contour Inserts

Troubleshooting

When groove width is greater than insert width, two methods are possible:

1 Multiple-Pass Grooving

Use the widest possible insert width to achieve optimal chip control and tool life. Make grooves 1, 2, and 3 first, then connect with passes 4 and 5. For passes 4 and 5, the material removed should be no more than 0.8 times the insert width.

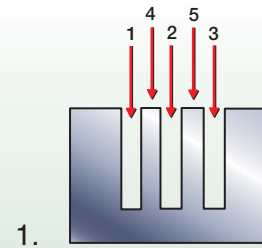

2 Grooving and Turning

For small and unstable workpieces, this is the preferred method to reduce vibrations experienced when axial grooving. The depth of cut in longitudinal turning should generally be 60–70% of the groove width. Turning in both directions improves tool life.

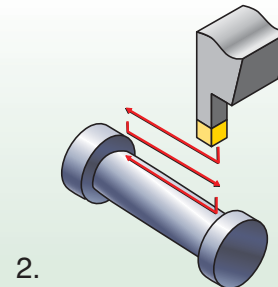

Choosing the Best Method:

- A** When the groove depth is greater than the groove width, multiple-pass plunge grooving offers the best results.
- B** When the groove width is greater than the groove depth, groove and turn (plunge/longitudinal turning) is easier and faster.

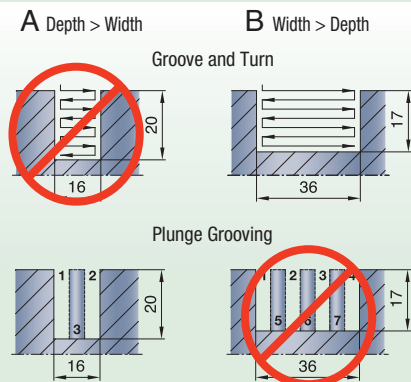

Finish Profiling

When finish profile machining internal chamfers or radii, take into account that the effective feed rate and chip cross section are reduced (the tool is cutting in both radial and axial directions). The drawing (right) shows the suggested processing sequence for the final pass to reduce vibrations.

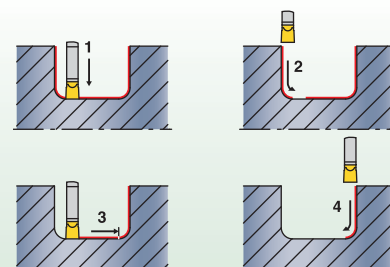

WMT Grooving Tool Application Guidelines

- Always use good general machining practices.
- Make the machine and workpiece setup as rigid as possible.
- Integral shank toolholders offer the best rigidity. They should be your first toolholder choice when possible.
- When changing inserts, make sure the new insert locates securely against the toolholder's positive stop.
- Never tighten the clamping screw without an insert in the pocket.
- Toolholder extension out of the tool block should be as short as possible.
- Inserts should cut as close to center as possible or slightly above.
- Dwell time in bottom of groove should be less than three revolutions.
- Recommended cutting speeds and feeds are a starting point. Adjust, as necessary, for optimum tool life and chip control.

On the Web



Fast, Free, and Easy Registration

You can easily register with www.widia.com to obtain full access to the features of the site.

Find a Local Authorized WIDIA™ Distributor in Your Area

The WIDIA Products Group offers world-class products and services globally. Our distributors know us, and more importantly, they know you. They know better than anyone in the industry how to put the global power of WIDIA to work for you — in your industry, in your region, and for your business.

Contact Us

Our customers are important to us. We want to provide you the best customer service in the industry. If you have a comment or question, please send it to us. We strive to respond to all inquiries within 24 hours.

WIDIA Products

Whether your operation is turning, milling, or holmaking, WIDIA brands are the high-performance tooling you need. We offer standard and custom solutions for the general engineering market.

WIDIA™ TopGroove™

WIDIA has set the industry standard for threading and grooving productivity with the TopGroove clamping design. The proven performance of this system has been enhanced with the addition of new insert geometries and the expansion of our carbide grade offering.

Let us help you select the correct insert for your application needs or upgrade your current TopGroove tooling inventory to include chip control geometries and the high productivity grades available from WIDIA.

Rigidity, Versatility, and Chip Control

- TopGroove clamping design features a rugged bridge clamp, which locates in a groove molded into the insert to provide superior resistance to side and radial cutting forces.
- TopGroove inserts are available for shallow grooving, deep grooving, light turning, profiling, shallow and deep face grooving, back turning, undercutting, and Poly-Vee grooving
- The patented WIDIA chip control design works in multi-directional turning as well as radial feed applications to provide excellent chip evacuation in deep grooving applications.

Rigid clamping generates locking forces in three directions to hold inserts in place through the toughest cuts.

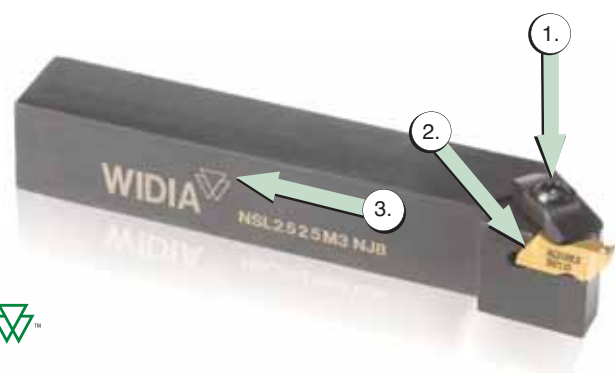

TopGroove inserts employ a unique top rake chip control geometry that efficiently evacuates chips and produces better quality parts faster.

The WIDIA™ TopGroove™ clamping system offers a complete line of grooving geometries and an extensive grade selection.



Carbide Grades and Proven Solutions for High Productivity

- The TopGroove system has a carbide grade to match your application needs that includes uncoated grades, PVD-coated grades, CVD-coated grades, and advanced material grades, including cermets, ceramics, PCBNs, and PCDs.
- New, improved PVD TiAlN-coated grades are designed to cut a variety of workpiece materials.
- Versatile design enables one system to handle OD and ID grooving, face grooving, back turning, undercutting, and even threading operations.
- New CVD TN7110 grade.

The Most Advanced Turning Solutions in the Industry

Perfect for shallow grooving operations, the WIDIA TopGroove clamping system provides a complete line of grooving geometries and an extensive grade selection to meet even the most demanding application requirements. For increased rigidity, versatility, chip control, and carbide grade options, the TopGroove clamping system is the proven solution.

With maximum clamping rigidity and superior versatility, TopGroove inserts employ a unique top rake chip control geometry that efficiently evacuates chips and produces better quality parts, faster than ever before.

Utilize this comprehensive, easy-to-use guide for the information necessary to identify, choose, and select the appropriate cutting tools for your specific needs.

What you need to know:

- Material being machined.
- Groove depth, width, and profile.
- Application to be performed (face, OD, or ID grooving).
- Toolholder requirements (e.g., KM™, Erickson™, square shank, right/left).

1 Choose the application to be performed:

Groove depth, width, and profile.

TopGroove is the best choice for groove depth-to-width ratios of 1.5 or less.

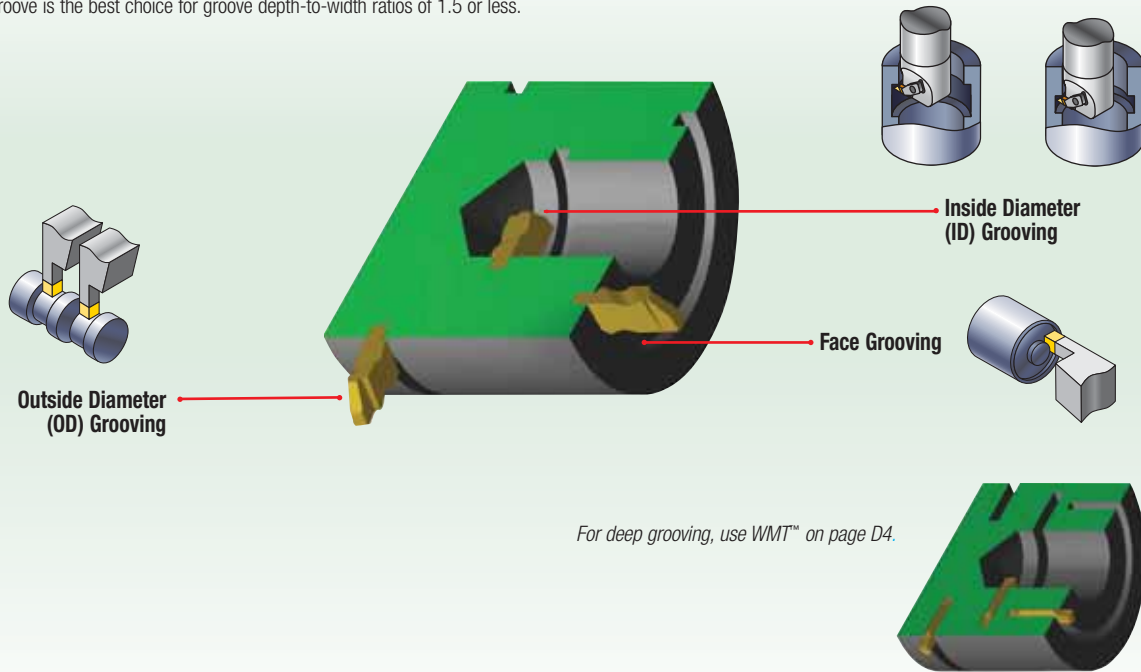

TopGroove™ for Internal, External, and Face Grooving Applications

system capabilities			minimum	maximum
	OD/ID Grooving	width	.020" (0,50mm)	.375" (9,53mm)
		depth	—	.500" (12,7mm)
	Face Grooving	width	.125" (3,2mm)	.250" (6,35mm)
		depth	—	.500" (12,7mm)
	Internal Grooving	diameter	.440" (11,2mm)	—
	Face Grooving Diameter	standard	.940" (23,9mm)	—
		deep	—	—
	Deep OD/ID Grooving	width	.059" (1,50mm)	.250" (6,35mm)
		depth	—	.500" (12,7mm)
	Deep Face Grooving	width	.125" (3,18mm)	.250" (6,35mm)
depth		—	.500" (12,7mm)	

2 Identify the material to be machined:

Each tool has a material grid marked with a letter indicating the materials that can be machined.

P	Steel
M	Stainless Steel
K	Cast Iron
N	Non-Ferrous Materials
S	High-Temp Alloys
H	Hardened Materials

3 Select your toolholder based on the application:

- A Choose the appropriate gage insert (width) required for the application.
- B Choose the shortest cutting depth "CD" dimension for increased tool rigidity.
- C Select the largest toolholder shank "H" and "B" dimensions for maximum rigidity.

TopGroove™
Toolholders

order number	catalog number	C						CD	A	clamp	clamp screw	Res/ Torx Plus
		H	B	F	L1	L2	BA					
3632147	NSR062	.375	.375	.562	2.50	.75	.35	.138	NL2R	CM74	S310	7/64
3639035	NSR062V	.500	.500	.750	3.50	.75	.35	.138	NL2R	CM74	S310	7/64
3639044	NSR102B	.625	.625	.875	4.50	.75	.35	.138	NL2R	CM74	S310	7/64
3639026	NSR122B	.750	.750	1.000	4.50	.75	.35	.138	NL2R	CM74	S310	7/64
3639025	NSR162C	1.000	1.000	1.250	5.00	.75	.35	.138	NL2R	CM74	S310	7/64
3639027	NSR123A	.750	.750	1.000	4.00	1.25	.50	.210	NL3R	CM72LP	S2112	25 P
3639023	NSR123B	.750	.750	1.000	4.50	1.25	.50	.210	NL3R	CM72LP	S2112	25 P
3638692	NSR163C	1.000	1.000	1.250	5.00	1.25	.50	.210	NL3R	CM72LP	S2112	25 P
3638691	NSR163D	1.000	1.000	1.250	6.00	1.25	.50	.210	NL3R	CM72LP	S2112	25 P
3639028	NSR203D	1.250	1.250	1.500	6.00	1.25	.50	.210	NL3R	CM72LP	S2112	25 P
3637509	NSR243D	1.500	1.500	2.000	6.00	1.38	.50	.210	NL3R	CM72LP	S2112	25 P
3637535	NSR243E	1.500	1.500	2.000	7.00	1.38	.50	.210	NL3R	CM72LP	S2112	25 P
3637496	NSR353D	1.250	1.000	1.250	6.00	1.25	.50	.210	NL3R	CM72LP	S2112	25 P
3637509	NSR205D	1.250	1.250	1.500	6.00	2.00	.61	.415	NL5R	CM80	S352	1/4
3637540	NSR345D	1.500	1.500	2.000	6.00	2.00	.61	.415	NL5R	CM80	S352	1/4
Left hand												
3632161	NSL062	.375	.375	.562	2.50	.75	.35	.138	NL2L	CM75	S310	7/64
3637495	NSL062V	.500	.500	.750	3.50	.75	.35	.138	NL2L	CM75	S310	7/64
3637510	NSL102B	.625	.625	.875	4.50	.75	.35	.138	NL2L	CM75	S310	7/64
3632145	NSL122B	.750	.750	1.000	4.50	.75	.35	.138	NL2L	CM75	S310	7/64
3632138	NSL162C	1.000	1.000	1.250	5.00	.75	.35	.138	NL2L	CM75	S310	7/64
3632152	NSL123A	.750	.750	1.000	4.00	1.25	.50	.210	NL3L	CM73LP	S2112	25 P

application	conventional toolholders	modular blades
<p>OD Grooving and Plunge and Turn</p>	page D38	—
<p>ID Grooving</p>	page D42	—

4 Select chipbreaker style for the application:

See application guide on page D44 for a complete list of insert styles.

NOTE: Chart shows recommended starting feed rates.

See page D45.

TopGroove™ Inserts
 Feed Values for Grooving

TopGroove • NG-K, NG-1L, and NG

NG-K

NG

- For general purpose, O-ring, and circle grooving applications.
- Chip control enables true optimization and productivity.
- Precision ground for accurate edge location.
- Can be used in both toolholders and boring bars.

Recommended feed

TopGroove • NGP and NGD-K

NGP

NGD-K

- Positive rake angles.
- For deep, O-ring, circle, and general purpose grooving applications.
- Chip geometry for excellent chip control.
- Precision ground for accurate edge location.
- Can be used in both toolholders and boring bars.

Recommended feed

TopGroove • NR and NR-K

NR

NR-K

- For full radius grooving and turning profiling applications.
- Chip geometry for excellent chip control.
- Precision ground for accurate edge location.
- Can be used in both toolholders and boring bars.

Recommended feed

A Choose the appropriate insert width "W" for your specific application.

B Select the required corner radius value "RR".

TopGroove™
 Grooving Inserts

● first choice
○ alternate choice

■ NG	catalog number	A		Ap max	B		T	insert size	TM6010	TM6025	TN7110	THM
		W	RR		mm	in						
	Right hand											
	NG2031R	0,78	.031	—	—	0,09	.0036	1,27	.050			
	NG2041R	1,04	.041	—	—	0,09	.0036	1,27	.050			
	NG2050R	1,47	.050	—	—	0,10	.0075	1,27	.050			
	NG2062R	1,58	.062	—	—	0,10	.0075	2,79	.110			
	NG3047R	1,10	.047	—	—	0,10	.0075	1,91	.075			
	NG3062R	1,58	.062	—	—	0,10	.0075	2,39	.094			
	NG3094R	2,39	.094	—	—	0,10	.0075	3,81	.150			
	NG3125R	3,18	.125	—	—	0,10	.0075	3,81	.150			

5 Select grade:

		Recommended Grades					
cutting condition		steel	stainless steel	cast iron	non-ferrous metals	high-temp alloys	hardened materials
smooth cut, pre-turned surface		TN7110	TN6010	TN7110	TN6010	TN6010	TN6010
varying depth of cut, casting, or forging skin		TN6010	TN6010	TN6010	TN6010	TN6010	TN6010
lightly interrupted cut		TN6025	TN6025	TN6025	TN6025	TN6025	TN6025
heavily interrupted cut		TN6025	TN6025	TN6025	TN6025	TN6025	TN6025

See page D46 for Grades and Grade Descriptions.

6 Determine cutting data:

- A Based on material group and grade, identify starting speed (vc).
- B First choice starting speed is in **bold**.

See page D48 for cutting data.

ANSI ISO 513		VDI 3323		Cutting Speed • vc SFM											
Material Group				TN6010			TN6025			TN7110			TNM		
		min	Start	max	min	Start	max	min	Start	max	min	Start	max		
P	1	455	570	685	425	455	490	655	705	750	295	310	325		
	2	425	520	620	390	520	655	620	800	960	295	340	455		
	3	360	455	555	325	425	520	520	670	820	225	295	360		
	4	390	490	590	390	490	590	590	750	915	260	340	425		
	5	325	425	520	325	425	520	490	630	785	225	295	360		
	6	390	490	590	390	490	590	590	750	915	260	340	425		
	7	325	425	520	295	410	520	455	620	785	195	275	360		
	8	295	390	490	260	360	455	390	555	720	160	245	325		
	9	195	295	390	195	260	325	295	410	520	130	160	225		
	10	295	340	390	260	310	360	425	490	555	195	225	260		
	11	160	210	260	160	210	260	260	340	425	130	160	195		
	12	390	505	620	390	455	520	590	685	785	260	310	360		
	13.1	295	390	490	360	340	425	425	540	655	195	245	295		
13.2	145	195	245	130	180	210	210	275	325	95	130	145			
M	14.1	295	390	490	195	245	295				195	245	295		
	14.2	245	325	390	160	195	245				160	195	245		
	14.3	180	245	310	130	160	180				130	160	180		
	14.4	145	195	245	95	130	145				95	130	145		
K	15	455	555	655	225	295	325	620	790	960	225	295	325		
	16	325	425	520	160	210	260	520	650	820	160	210	260		
	17	390	490	590	195	225	260	590	750	920	195	225	260		
	18	295	390	490	130	180	225	390	560	720	130	180	225		
	19	490	590	685	260	310	360	620	790	960	260	310	360		
20	360	455	555	195	245	295	590	750	920	195	245	295			
N	21	1965	2400	2950	1965	2400	2950				1965	2400	2950		
	22	1640	2130	2620	1640	2130	2620				1640	2130	2620		
	23	1965	2400	2950	1965	2400	2950				1965	2400	2950		
	24	1640	2130	2620	1640	2130	2620				1640	2130	2620		
	25	750	980	1210	750	980	1210				750	980	1210		
	26	490	655	820	490	655	820				490	655	820		
	27	490	655	820	490	655	820				490	655	820		
	28	360	455	555	360	455	555				360	455	555		
	29	195	260	325	195	260	325				195	260	325		
	30	260	325	390	260	325	390				260	325	390		
S	31	120	145	180	85	120	145				85	120	145		
	32	85	115	145	65	95	115				65	95	115		
	33	75	90	115	55	75	90				55	75	90		
	34	45	55	80	35	45	55				35	45	55		
	35	50	55	80	35	50	55				35	50	55		
	36	195	235	260	135	195	235				135	195	235		

TopGroove Holder Identification System



NSR163D

N

Insert Holding Method

N — TopGroove*

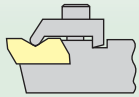

*Proprietary standard only.

S

Insert Mounting Location

End mount



Side mount Offset

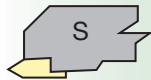

Side mount No offset for swiss machining

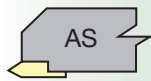

NRR Undercut

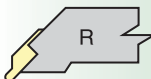

R

Hand of Tool

Drop Head

Drop Head

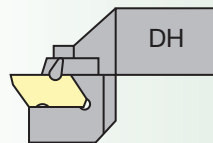

16

Shank Size

Inch:

For shanks 5/8" square and larger, the number represents the number of sixteenths of width and height. For shanks under 5/8" square, the number of sixteenths of cross section is preceded by a zero. For rectangular holders, the first digit represents the number of eighths of width and the second digit the number of quarters of height, except for a toolholder 1-1/4" x 1-1/2", which is given the number 91.

3

Insert Size

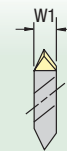

insert size	W1
2	.150"
3	.195"
4	.255"
5	.380"
6	.383"
8	.438"

D

Qualified Surface and Length

- A — qualified back and end, 4" long
- B — qualified back and end, 4.5" long
- C — qualified back and end, 5" long
- D — qualified back and end, 6" long
- E — qualified back and end, 7" long
- V — qualified back and end, 3.5" long*

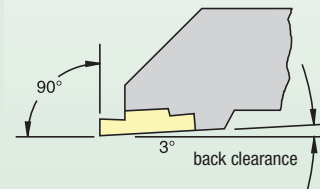

NOTE: Holders are designed to locate insert inclined to 3° to provide back clearance down open side.

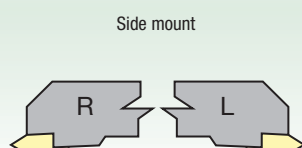
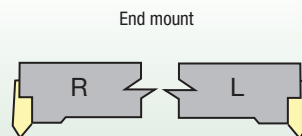

**TopGroove
Boring Bar Identification System**



A
Bar Type

Steel with coolant

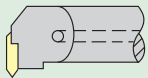

32
Bar Diameter

A two-digit number that indicates the bar diameter in 1/16" increments.

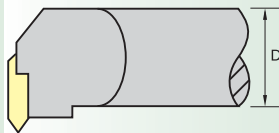

N
Insert Holding Method

N — TopGroove

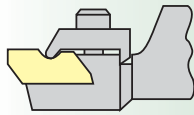

E
Insert Location

End mount

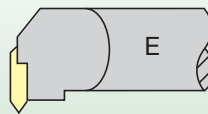

Side mount

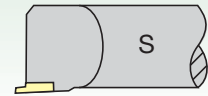

R
Hand of Tool

Right hand

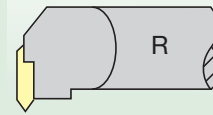

Left hand

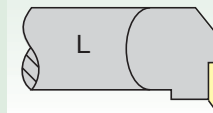

3
Insert Size

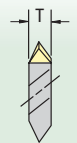

insert size	T
1	.100"
2	.150"
3	.195"
4	.255"
5	.380"
6	.383"
8	.438"

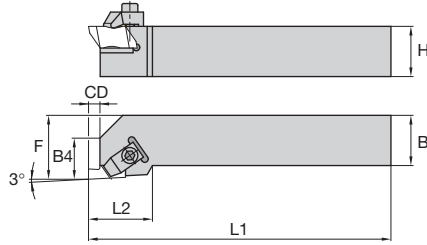
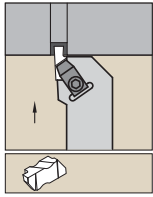

■ NS

Grooving, Cut-Off, and Turning • TopGroove

order number	catalog number	H	B	F	L1	L2	B4	CD	gage insert	clamp	clamp screw	hex/ Torx Plus
Right hand												
3632147	NSR062	.375	.375	.562	2.50	.75	.35	.138	N.2R	CM74	S310	7/64
3639035	NSR082V	.500	.500	.750	3.50	.75	.35	.138	N.2R	CM74	S310	7/64
3639044	NSR102B	.625	.625	.875	4.50	.75	.35	.138	N.2R	CM74	S310	7/64
3639026	NSR122B	.750	.750	1.000	4.50	.75	.35	.138	N.2R	CM74	S310	7/64
3639025	NSR162C	1.000	1.000	1.250	5.00	.75	.35	.138	N.2R	CM74	S310	7/64
3639027	NSR123A	.750	.750	1.000	4.00	1.25	.50	.210	N.3R	CM72LP	S2112	25 IP
3639023	NSR123B	.750	.750	1.000	4.50	1.25	.50	.210	N.3R	CM72LP	S2112	25 IP
3638592	NSR163C	1.000	1.000	1.250	5.00	1.25	.50	.210	N.3R	CM72LP	S2112	25 IP
3638591	NSR163D	1.000	1.000	1.250	6.00	1.25	.50	.210	N.3R	CM72LP	S2112	25 IP
3639028	NSR203D	1.250	1.250	1.500	6.00	1.25	.50	.210	N.3R	CM72LP	S2112	25 IP
3637506	NSR243D	1.500	1.500	2.000	6.00	1.38	.50	.210	N.3R	CM72LP	S2112	25 IP
3637535	NSR243E	1.500	1.500	2.000	7.00	1.38	.50	.210	N.3R	CM72LP	S2112	25 IP
3637496	NSR853D	1.250	1.000	1.250	6.00	1.25	.50	.210	N.3R	CM72LP	S2112	25 IP
3637509	NSR205D	1.250	1.250	1.500	6.00	2.00	.61	.415	N.5R	CM80	S352	1/4
3637540	NSR245D	1.500	1.500	2.000	6.00	2.00	.61	.415	N.5R	CM80	S352	1/4
Left hand												
3632161	NSL062	.375	.375	.562	2.50	.75	.35	.138	N.2L	CM75	S310	7/64
3637485	NSL082V	.500	.500	.750	3.50	.75	.35	.138	N.2L	CM75	S310	7/64
3637510	NSL102B	.625	.625	.875	4.50	.75	.35	.138	N.2L	CM75	S310	7/64
3632145	NSL122B	.750	.750	1.000	4.50	.75	.35	.138	N.2L	CM75	S310	7/64
3632138	NSL162C	1.000	1.000	1.250	5.00	.75	.35	.138	N.2L	CM75	S310	7/64
3632152	NSL123A	.750	.750	1.000	4.00	1.25	.50	.210	N.3L	CM73LP	S2112	25 IP
3639032	NSL123B	.750	.750	1.000	4.50	1.25	.50	.210	N.3L	CM73LP	S2112	25 IP
3639029	NSL163C	1.000	1.000	1.250	5.00	1.25	.50	.210	N.3L	CM73LP	S2112	25 IP
3639024	NSL163D	1.000	1.000	1.250	6.00	1.25	.50	.210	N.3L	CM73LP	S2112	25 IP
3639037	NSL203D	1.250	1.250	1.500	6.00	1.25	.50	.210	N.3L	CM73LP	S2112	25 IP
3637515	NSL243D	1.500	1.500	2.000	6.00	1.38	.50	.210	N.3L	CM73LP	S2112	25 IP
3637548	NSL243E	1.500	1.500	2.000	7.00	1.38	.50	.210	N.3L	CM73LP	S2112	25 IP
3637508	NSL853D	1.250	1.000	1.250	6.00	1.25	.50	.210	N.3L	CM73LP	S2112	25 IP
3637536	NSL205D	1.250	1.250	1.500	6.00	2.00	.61	.415	N.5L	CM81	S352	1/4

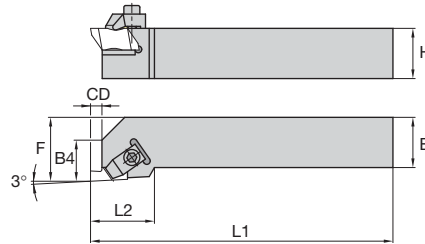
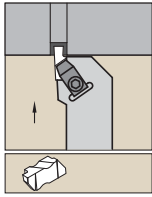

■ NS (with shim)

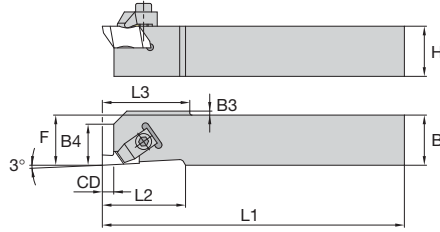
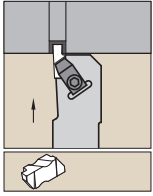
order number	catalog number	H	B	F	L1	L2	B4	CD	gage insert	clamp clamp	hex/ Torx Plus	shim shim	shim screw	shim ID	screw drive size
	Right hand														
3639031	NSR164C	1.000	1.000	1.250	5.00	1.38	.54	.294	N.4R	CM72LP	S2112	25 IP	SM420	SL344	—
3639033	NSR164D	1.000	1.000	1.250	6.00	1.38	.54	.294	N.4R	CM72LP	S2112	25 IP	SM420	SL344	—
3637529	NSR204C	1.250	1.250	1.500	5.00	1.38	.54	.294	N.4R	CM72LP	S2112	25 IP	SM420	SL344	—
3639034	NSR204D	1.250	1.250	1.500	6.00	1.38	.54	.294	N.4R	CM72LP	S2112	25 IP	SM420	SL344	—
3637484	NSR244D	1.500	1.500	2.000	6.00	1.50	.54	.294	N.4R	CM72LP	S2112	25 IP	SM420	SL344	—
3637501	NSR244E	1.500	1.500	2.000	7.00	1.50	.54	.294	N.4R	CM72LP	S2112	25 IP	SM420	SL344	—
3637526	NSR854D	1.250	1.000	1.250	6.00	1.38	.54	.294	N.4R	CM72LP	S2112	25 IP	SM420	SL344	—
3637534	NSR864E	1.500	1.000	1.250	7.00	1.38	.54	.294	N.4R	CM72LP	S2112	25 IP	SM420	SL344	—
3632153	NSR166D	1.000	1.000	1.250	6.00	1.38	.67	.334	N.6R	CM120	S412	5/32	SM416	S111	1/16
3637472	NSR206D	1.250	1.250	1.500	6.00	1.38	.67	.334	N.6R	CM120	S412	5/32	SM416	S111	1/16
3637520	NSR246D	1.500	1.500	2.000	6.00	1.50	.67	.334	N.6R	CM120	S412	5/32	SM416	S111	1/16
3637539	NSR168D	1.000	1.000	1.250	6.00	1.25	.72	.225	N.8R	CM144	S422	3/16	SM419	S112	1/16
	Left hand														
3632151	NSL164C	1.000	1.000	1.250	5.00	1.38	.54	.294	N.4L	CM73LP	S2112	25 IP	SM420	SL344	—
3639040	NSL164D	1.000	1.000	1.250	6.00	1.38	.54	.294	N.4L	CM73LP	S2112	25 IP	SM420	SL344	—
3641699	NSL204C	1.250	1.250	1.500	5.00	1.38	.54	.294	N.4L	CM73LP	S2112	25 IP	SM420	SL344	—
3639036	NSL204D	1.250	1.250	1.500	6.00	1.38	.54	.294	N.4L	CM73LP	S2112	25 IP	SM420	SL344	—
3637505	NSL244D	1.500	1.500	2.000	6.00	1.50	.54	.294	N.4L	CM73LP	S2112	25 IP	SM420	SL344	—
3637533	NSL244E	1.500	1.500	2.000	7.00	1.50	.54	.294	N.4L	CM73LP	S2112	25 IP	SM420	SL344	—
3637541	NSL854D	1.250	1.000	1.250	6.00	1.38	.54	.294	N.4L	CM73LP	S2112	25 IP	SM420	SL344	—
3641700	NSL864E	1.500	1.000	1.250	7.00	1.38	.54	.294	N.4L	CM73LP	S2112	25 IP	SM420	SL344	—
3637487	NSL166D	1.000	1.000	1.250	6.00	1.38	.67	.334	N.6L	CM121	S412	5/32	SM416	S111	1/16
3637507	NSL206D	1.250	1.250	1.500	6.00	1.38	.67	.334	N.6L	CM121	S412	5/32	SM416	S111	1/16
3637546	NSL246D	1.500	1.500	2.000	6.00	1.50	.67	.334	N.6L	CM121	S412	5/32	SM416	S111	1/16

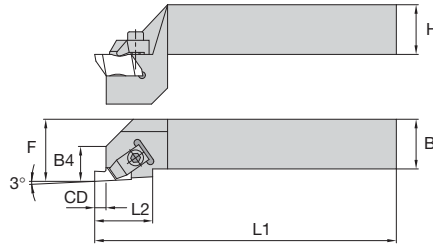
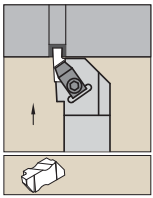

■ NAS (for Swiss Machines)

order number	catalog number	H	B	F	L1	L2	B4	CD	B3	L3	gage insert	clamp	clamp screw	hex/Torx Plus
	Right hand													
3632140	NASR062D	.375	.375	.375	6.00	.75	.35	.138	.07	.88	N.2R	CM182	S310	7/64
3636529	NASR082D	.500	.500	.500	6.00	.75	.35	.138	—	—	N.2R	CM182	S310	7/64
3639039	NASR102B	.625	.625	.625	4.50	.75	.35	.138	—	—	N.2R	CM74	S310	7/64
3639042	NASR083D	.500	.500	.500	6.00	1.25	.50	.210	.13	1.32	N.3R	CM184LP	S2112	25 IP
3636532	NASR103B	.625	.625	.625	4.50	1.25	—	.210	—	—	N.3R	CM184LP	S2112	25 IP
	Left hand													
3637531	NASL062D	.375	.375	.375	6.00	.75	.35	.138	.07	.88	N.2L	CM183	S310	7/64
3636534	NASL082D	.500	.500	.500	6.00	.75	.35	.138	—	—	N.2L	CM183	S310	7/64
3637489	NASL102B	.625	.625	.625	4.50	.75	.35	.138	—	—	N.2L	CM75	S310	7/64
3637497	NASL083D	.500	.500	.500	6.00	1.25	.50	.210	.13	1.32	N.3L	CM185	S412	25 IP
3636524	NASL103B	.625	.625	.625	4.50	1.25	—	.210	—	—	N.3L	CM185LP	S2112	25 IP



■ NS-DH

order number	catalog number	H	B	F	L1	L2	B4	CD	gage insert	clamp	clamp screw	hex/Torx Plus	jack screw	wrench size jack screw
	Right hand													
3637547	NSRDH122B	.750	.750	1.000	4.50	.75	.40	.138	N.2R	CM74	S310	7/64	—	—
3637499	NSRDH163C	1.000	1.000	1.250	5.00	1.25	.58	.210	N.3R	CM72LP	S2112	25 IP	—	—
3637528	NSRDH163D	1.000	1.000	1.250	6.00	1.25	.58	.210	N.3R	CM72LP	S2112	25 IP	—	—
3637511	NSRDH203D	1.250	1.250	1.500	6.00	1.25	.62	.210	N.3R	CM72LP	S2112	25 IP	S965	3/16
3637530	NSRDH204D	1.250	1.250	1.500	6.00	1.38	.62	.294	N.4R	CM72LP	S2112	25 IP	S965	3/16
	Left hand													
3637518	NSLDH203D	1.250	1.250	1.500	6.00	1.25	.62	.210	N.3L	CM73LP	S2112	25 IP	S965	3/16

Grooving, Cut-Off, and Turning • TopGroove

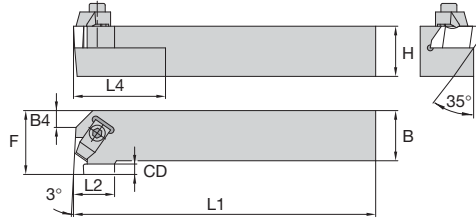
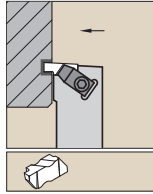

■ NE

order number	catalog number	H	B	F	L1	L2	L4	B4	CD	gage insert	clamp	clamp screw	hex/ Torx Plus
	Right hand												
3637521	NER062	.375	.375	.750	2.50	.50	.50	—	.138	N.2L	CM75	S310	7/64
3637494	NER082V	.500	.500	.750	3.50	.50	1.00	—	.138	N.2L	CM75	S310	7/64
3637517	NER102B	.625	.625	.750	4.50	—	1.00	—	.138	N.2L	CM75	S310	7/64
3632156	NER122B	.750	.750	1.000	4.50	.50	1.00	.29	.138	N.2L	CM75	S310	7/64
3637486	NER162C	1.000	1.000	1.250	5.00	.50	1.00	.41	.138	N.2L	CM75	S310	7/64
3632133	NER123B	.750	.750	1.125	4.50	.75	2.00	—	.210	N.3L	CM73LP	S2112	25 IP
3639030	NER163D	1.000	1.000	1.250	6.00	.75	2.00	—	.210	N.3L	CM73LP	S2112	25 IP
3639038	NER163C	1.000	1.000	1.250	5.00	.75	2.00	—	.210	N.3L	CM73LP	S2112	25 IP
3632150	NER203D	1.250	1.250	1.500	6.00	.75	2.00	.26	.210	N.3L	CM73LP	S2112	25 IP
3637523	NER853D	1.250	1.000	1.250	6.00	.75	2.00	—	.210	N.3L	CM73LP	S2112	25 IP
3637524	NER243D	1.500	1.500	2.000	6.00	.75	2.00	.76	.210	N.3L	CM73LP	S2112	25 IP
3639043	NER164D	1.000	1.000	1.375	6.00	.75	2.00	—	.294	N.4L	CM73LP	S2112	25 IP
3637492	NER164C	1.000	1.000	1.375	5.00	.75	2.00	—	.294	N.4L	CM73LP	S2112	25 IP
3632157	NER204D	1.250	1.250	1.625	6.00	.75	2.00	.27	.294	N.4L	CM73LP	S2112	25 IP
3637522	NER244D	1.500	1.500	2.000	6.00	.75	2.00	.65	.294	N.4L	CM73LP	S2112	25 IP
3637542	NER205D	1.250	1.250	2.000	6.00	1.44	2.00	—	.415	N.5L	CM81	S352	1/4
3637544	NER206D	1.250	1.250	1.625	6.00	.75	2.00	.27	.300	N.6L	CM121	S412	5/32
	Left hand												
3637525	NEL062	.375	.375	.750	2.50	.50	.50	—	.138	N.2R	CM74	S310	7/64
3632158	NEL082V	.500	.500	.750	3.50	.50	1.00	—	.138	N.2R	CM74	S310	7/64
3637532	NEL102B	.625	.625	.750	4.50	—	1.00	—	.138	N.2R	CM74	S310	7/64
3637503	NEL122B	.750	.750	1.000	4.50	.50	1.00	.29	.138	N.2R	CM74	S310	7/64
3637500	NEL162C	1.000	1.000	1.250	5.00	.50	1.00	.41	.138	N.2R	CM74	S310	7/64
3632144	NEL123B	.750	.750	1.125	4.50	.75	2.00	—	.210	N.3R	CM72LP	S2112	25 IP
3639041	NEL163D	1.000	1.000	1.250	6.00	.75	2.00	—	.210	N.3R	CM72LP	S2112	25 IP
3632155	NEL163C	1.000	1.000	1.250	5.00	.75	2.00	—	.210	N.3R	CM72LP	S2112	25 IP
3632154	NEL203D	1.250	1.250	1.500	6.00	.75	2.00	.26	.210	N.3R	CM72LP	S2112	25 IP
3637538	NEL853D	1.250	1.000	1.250	6.00	.75	2.00	—	.210	N.3R	CM72LP	S2112	25 IP
3637537	NEL243D	1.500	1.500	2.000	6.00	.75	2.00	.76	.210	N.3R	CM72LP	S2112	25 IP
3637493	NEL164C	1.000	1.000	1.375	5.00	.75	2.00	—	.294	N.4R	CM72LP	S2112	25 IP
3632162	NEL164D	1.000	1.000	1.375	6.00	.75	2.00	—	.294	N.4R	CM72LP	S2112	25 IP
3632159	NEL204D	1.250	1.250	1.625	6.00	.75	2.00	.27	.294	N.4R	CM72LP	S2112	25 IP
3637543	NEL244D	1.500	1.500	2.000	6.00	.75	2.00	.65	.294	N.4R	CM72LP	S2112	25 IP
3637549	NEL205D	1.250	1.250	2.000	6.00	1.44	2.00	—	.415	N.5R	CM80	S352	1/4
3641697	NEL206D	1.250	1.250	1.625	6.00	.75	2.00	.27	.300	N.6R	CM120	S412	5/32

Grooving, Cut-Off, and Turning • TopGroove

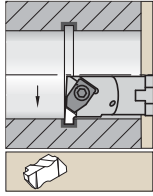

Steel shank with through coolant.

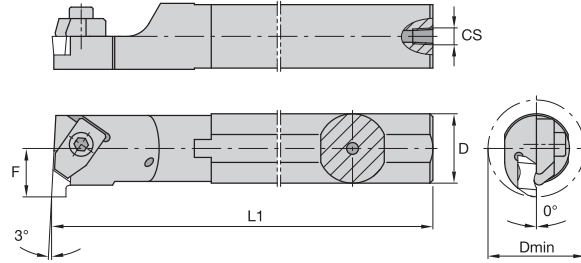

■ A-NE

Grooving, Cut-Off, and Turning • TopGroove

order number	catalog number	D	D min	L1	F	CS	gage insert	clamp	clamp screw	hex/ Torx Plus
	Right hand									
3632117	A08NER2	.500	.730	8.000	.437	1/16-27 NPT	N.2L	CM147	S39	7/64
3632114	A10NER2	.625	1.000	10.000	.500	1/8-27 NPT	N.2L	CM75	S310	7/64
3632118	A12NER2	.750	1.125	10.000	.562	1/8-27 NPT	N.2L	CM75	S310	7/64
3632130	A16NER2	1.000	1.375	12.000	.688	1/4-18 NPT	N.2L	CM75	S310	7/64
3632113	A16NER3	1.000	1.375	12.000	.688	1/4-18 NPT	N.3L	CM73LP	S2112	25 IP
3632116	A20NER3	1.250	1.750	14.000	.875	1/4-18 NPT	N.3L	CM73LP	S2112	25 IP
3632115	A24NER3	1.500	2.000	14.000	1.000	1/4-18 NPT	N.3L	CM73LP	S2112	25 IP
3632132	A28NER3	1.750	2.250	14.000	1.125	1/4-18 NPT	N.3L	CM73LP	S2112	25 IP
3632122	A32NER3	2.000	2.500	16.000	1.250	1/4-18 NPT	N.3L	CM73LP	S2112	25 IP
3632146	A40NER3	2.500	3.000	16.000	1.500	1/4-18 NPT	N.3L	CM73LP	S2112	25 IP
3632123	A28NER4	1.750	2.500	14.000	1.250	1/4-18 NPT	N.4L	CM73LP	S2112	25 IP
3632125	A32NER4	2.000	2.750	16.000	1.375	1/4-18 NPT	N.4L	CM73LP	S2112	25 IP
3632136	A40NER4	2.500	3.250	16.000	1.625	1/4-18 NPT	N.4L	CM73LP	S2112	25 IP
3637514	A32NER5	2.000	2.812	16.000	1.406	1/4-18 NPT	N.5L	CM81	S352	1/4
3632143	A32NER6	2.000	2.750	16.000	1.375	1/4-18 NPT	N.6L	CM121	S412	5/32
3637498	A40NER6	2.500	3.250	16.000	1.625	1/4-18 NPT	N.6L	CM121	S412	5/32
	Left hand									
3632131	A08NEL2	.500	.730	8.000	.437	1/16-27 NPT	N.2R	CM146	S39	7/64
3632127	A10NEL2	.625	1.000	10.000	.500	1/8-27 NPT	N.2R	CM74	S310	7/64
3632126	A12NEL2	.750	1.125	10.000	.562	1/8-27 NPT	N.2R	CM74	S310	7/64
3632142	A16NEL2	1.000	1.375	12.000	.688	1/4-18 NPT	N.2R	CM74	S310	7/64
3632120	A16NEL3	1.000	1.375	12.000	.688	1/4-18 NPT	N.3R	CM72LP	S2112	25 IP
3632124	A20NEL3	1.250	1.750	14.000	.875	1/4-18 NPT	N.3R	CM72LP	S2112	25 IP
3632128	A24NEL3	1.500	2.000	14.000	1.000	1/4-18 NPT	N.3R	CM72LP	S2112	25 IP
3637490	A28NEL3	1.750	2.250	14.000	1.125	1/4-18 NPT	N.3R	CM72LP	S2112	25 IP
3632139	A32NEL3	2.000	2.500	16.000	1.250	1/4-18 NPT	N.3R	CM72LP	S2112	25 IP
3637504	A40NEL3	2.500	3.000	16.000	1.500	1/4-18 NPT	N.3R	CM72LP	S2112	25 IP
3632141	A28NEL4	1.750	2.500	14.000	1.250	1/4-18 NPT	N.4R	CM72LP	S2112	25 IP
3632149	A32NEL4	2.000	2.750	16.000	1.375	1/4-18 NPT	N.4R	CM72LP	S2112	25 IP
3637491	A40NEL4	2.500	3.250	16.000	1.625	1/4-18 NPT	N.4R	CM72LP	S2112	25 IP
3637527	A32NEL5	2.000	2.812	16.000	1.406	1/4-18 NPT	N.5R	CM80	S352	1/4
3637512	A32NEL6	2.000	2.750	16.000	1.375	1/4-18 NPT	N.6R	CM120	S412	5/32

NOTE: Minimum bore capability varies with depth of groove. See pages D66–D67 for details.

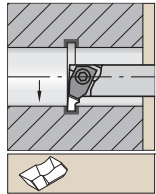

Necked steel shank with through coolant.

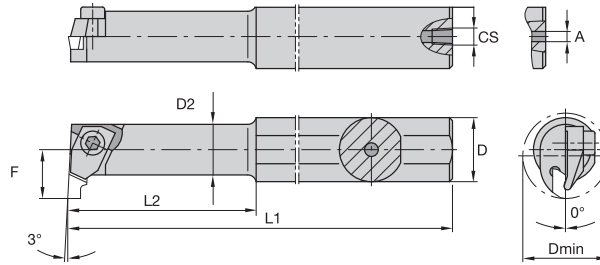

■ **A-NE-1**

order number	catalog number	D	D min	D2	L1	L2	F	A	CS	gage insert	clamp	clamp screw	hex/ Torx Plus
	Right hand												
3632121	A06NER1	.375	.440	.312	6	1.25	.258	.125	—	N.1L	CM109	S304	5/64
3632119	A08NER1	.500	.440	.312	8	1.25	.258	—	1/16-27 NPT	N.1L	CM109	S304	5/64
3632148	A10NER1	.625	.800	—	10	—	.406	—	1/8-27 NPT	N.1L	CM109	S304	5/64

NOTE: Minimum bore capability varies with depth of groove. See pages D66–D67 for details.

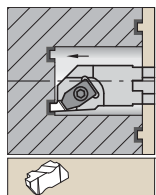

Steel shank with through coolant.

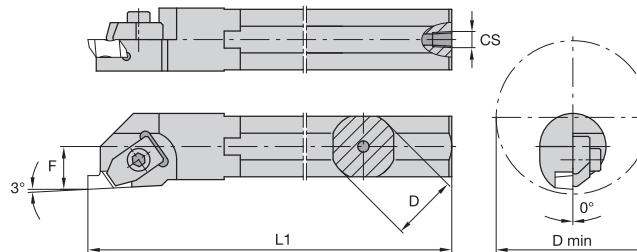

■ **A-NS**

order number	catalog number	D	D min	L1	F	CS	gage insert	clamp	clamp screw	hex/ Torx Plus
	Right hand									
3632129	A16TNSR3	1.000	2.250	12	.640	1/4-18 NPT	N.3R	CM72LP	S2112	25 IP
3632135	A20UNSR3	1.250	2.250	14	.765	1/4-18 NPT	N.3R	CM72LP	S2112	25 IP
3632134	A24UNSR3	1.500	2.250	14	.890	1/4-18 NPT	N.3R	CM72LP	S2112	25 IP
3637516	A28UNSR3	1.750	2.250	14	1.015	1/4-18 NPT	N.3R	CM72LP	S2112	25 IP
3632160	A32VNSR3	2.000	2.375	16	1.281	1/4-18 NPT	N.3R	CM72LP	S2112	25 IP
3637513	A40VNSR3	2.500	2.875	16	1.531	1/4-18 NPT	N.3R	CM72LP	S2112	25 IP
	Left hand									
3632137	A16TNSL3	1.000	2.250	12	.640	1/4-18 NPT	N.3L	CM73LP	S2112	25 IP
3637495	A20UNSL3	1.250	2.250	14	.765	1/4-18 NPT	N.3L	CM73LP	S2112	25 IP
3637488	A24UNSL3	1.500	2.250	14	.890	1/4-18 NPT	N.3L	CM73LP	S2112	25 IP
3637502	A32VNSL3	2.000	2.375	16	1.281	1/4-18 NPT	N.3L	CM73LP	S2112	25 IP

NOTE: Minimum bore capability varies with depth of groove. See pages D66–D67 for details.

insert style	application	rake angle	page(s)	insert style	application	rake angle	page(s)
NG 	<ul style="list-style-type: none"> • General-purpose grooving. • O-ring grooving. • Circlip grooving. 	neutral	D49	NFD-KI* 	<ul style="list-style-type: none"> • Internal deep face grooving with chip control. • For use in boring bars for internal face grooves. 	10° positive	—
NG-K 	<ul style="list-style-type: none"> • Chip control geometry. • General-purpose grooving. • O-ring grooving. • Circlip grooving. • Light turning. 	10° positive	D50	NP-K 	<ul style="list-style-type: none"> • Turning. • Back turning positive. • Profiling with chip control. 	10° positive	D56
NGC-K* 	<ul style="list-style-type: none"> • Combined groove and chamfered edge break in one positive plunge with chip control. • Designed for DIN 471/472 standard circlip grooves. 	10° positive	—	NR 	<ul style="list-style-type: none"> • Full radius grooving. • Turning and profiling. 	neutral	D56
NGD* 	<ul style="list-style-type: none"> • Deep grooving. 	neutral	—	NR-K 	<ul style="list-style-type: none"> • Chip control geometry. • Full radius grooving, turning, and profiling. 	10° positive	D58
NGD-K 	<ul style="list-style-type: none"> • Chip control geometry. • Deep grooving. • Light turning. 	10° positive	D53	NRD 	<ul style="list-style-type: none"> • Deep grooving. • Full radius end-form. 	neutral	D58
NGP 	<ul style="list-style-type: none"> • General-purpose grooving. • O-ring grooving. • Circlip grooving. 	5° positive	D54	NRP* 	<ul style="list-style-type: none"> • Full radius grooving. • Light-turning profiling. 	5° positive	—
NF* 	<ul style="list-style-type: none"> • Face grooving. • Additional side clearance. 	neutral	—	NU* 	<ul style="list-style-type: none"> • Undercutting. 	neutral	—
NF-K 	<ul style="list-style-type: none"> • Face grooving with chip control. • Additional side clearance. 	10° positive	D55	NV* 	<ul style="list-style-type: none"> • Poly-Vee grooving. 	neutral	—
NFD-K 	<ul style="list-style-type: none"> • Deep face grooving with chip control. • Additional side clearance. 	10° positive	D55	NB/NBD 	<ul style="list-style-type: none"> • Blanks. • Blanks for deep grooving. • Available in uncoated grades only. 	—	D59

*Inserts are available as custom solutions.

TopGroove • NG-K, NG-1L, and NG

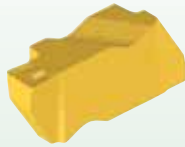

NG-K

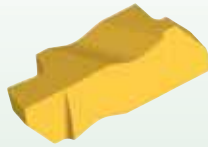

NG

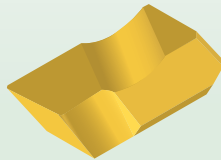

NG-1L

- Chip control enables true optimization and productivity.
- For general-purpose, O-ring, and circlip grooving applications.
- Precision ground for accurate edge location.
- Can be used in both toolholders and boring bars.

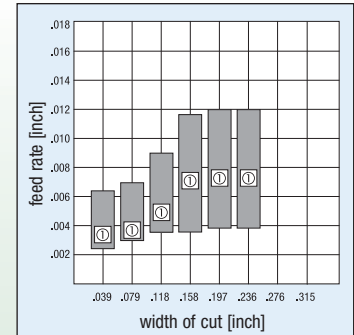

① Recommended feed

TopGroove • NGP and NGD-K

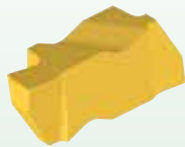

NGP

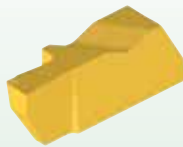

NGD-K

- Positive rake angles.
- For deep, O-ring, circlip, and general-purpose grooving applications.
- Chip geometry for excellent chip control.
- Precision ground for accurate edge location.
- Can be used in both toolholders and boring bars.

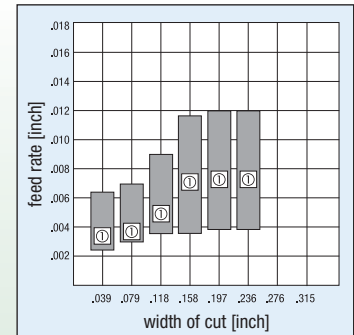

① Recommended feed

TopGroove • NR and NR-K

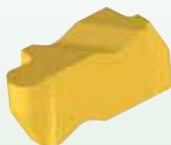

NR

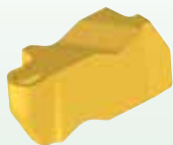

NR-K

- For full radius grooving and turning profiling applications.
- Chip geometry for excellent chip control.
- Precision ground for accurate edge location.
- Can be used in both toolholders and boring bars.

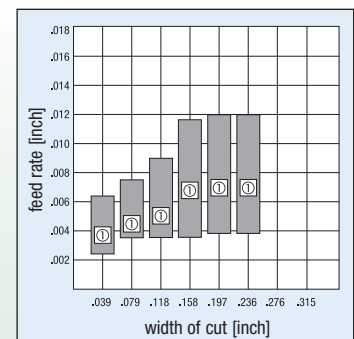

① Recommended feed

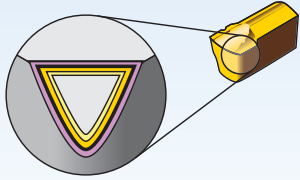

Coatings provide high-speed capability and are engineered for finishing to light roughing.

P	Steel
M	Stainless Steel
K	Cast Iron
N	Non-Ferrous Materials
S	High-Temp Alloys
H	Hardened Materials

Grade	Coating		Grade Description	Material																		
	Coating	Grade Description		05	10	15	20	25	30	35	40	45										
TN6010		Coated carbide. PVD — TiAlN Nano-multi-layer. Light machining. For difficult-to-machine alloys.	P																			
	HC-S10		M																			
TN6025		Coated carbide. PVD — TiAlN Nano-multi-layer. Light and medium machining. For difficult-to-machine alloys.	K																			
	HC-S25		N																			
TN7110		Coated carbide. MTCVD/CVD — TiN-TiCN-Al ₂ O ₃ -TiN. Very wear resistant. Light and medium machining. For steels and nodular cast iron.	S																			
	HC-P10		H																			
THM		Uncoated carbide. Extraordinarily good balance of hardness, wear resistance, edge stability, and toughness. Light and medium machining. For cast iron and all non-ferrous metals and non-metals. Useful in unfavorable conditions.	P																			
	HW-K15		M																			



TopGroove Insert Identification System

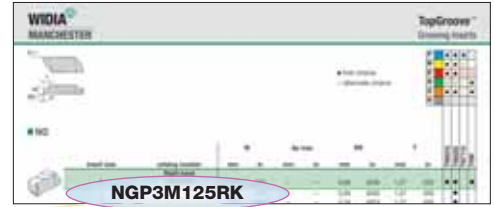

N

Type of Insert

N — TopGroove

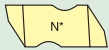

G

Insert Style

- B — Blank (for special forms)
- F — Face grooving
- G — Grooving
- P — Back turning
- R — Full radius
- U — Undercutting (or relieving)
- V — Poly-Vee

P

Additional Information

- D — Deep grooving
- P — Positive
- C — Groove and chamfer

3

Insert Size

insert size	S		W1	
	inch	mm	inch	mm
1	.100	2,54	.100	2,54
2	.219	5,56	.150	3,81
3	.344	8,74	.195	4,95
4	.453	11,51	.255	6,98
5	.688	17,48	.380	9,65
6	.453	11,51	.383	9,73

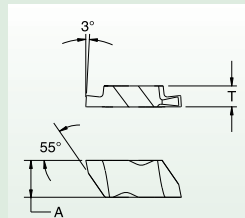

M

Size Identification

- M — Metric insert groove width
- C — Circlip groove insert width is nominal circlip size
- Blank — indicates inch width insert

Groove width for F-, G-, and U-style inserts; radii for R-style grooving inserts; and circlip size for groove and chamfer inserts. Dimension in .001".

inch example
1/32 = .031"

Width Tolerance: ±.001" unless otherwise specified

**Omit position for TopGroove NB-style blanks.

125

Groove Size**

R

Hand of Insert

- L — Left hand
- R — Right hand

Shown for groove and chamfer inserts in .0004" increments.

Blank

Cutting Depth

K

Chipbreaker Design

- K — Standard chip control
- E — Hone only

Groove size

- J or L — Poly-Vee inserts
- I — Internal face grooving

Grooving, Cut-Off, and Turning • TopGroove

ANSI ISO 513	VDI 3323	Cutting Speed • vc SFM											
Material Group		Cutting Speed • vc SFM											
		min	Start	max	min	Start	max	min	Start	max	min	Start	max
P		TN6010			TN6025			TN7110			THM		
	1	455	570	685	425	455	490	655	705	750	295	310	325
	2	425	520	620	390	520	655	620	800	980	295	340	455
	3	360	455	555	325	425	520	520	670	820	225	295	360
	4	390	490	590	390	490	590	590	750	915	260	340	425
	5	325	425	520	325	425	520	490	635	785	225	295	360
	6	390	490	590	390	490	590	590	750	915	260	340	425
	7	325	425	520	295	410	520	455	620	785	195	275	360
	8	295	390	490	260	360	455	390	555	720	160	245	325
	9	195	295	390	195	260	325	295	410	520	130	160	225
	10	295	340	390	260	310	360	425	490	555	195	225	260
	11	160	210	260	160	210	260	260	340	425	130	160	195
	12	390	505	620	390	455	520	590	685	785	260	310	360
13.1	295	390	490	260	340	425	425	540	655	195	245	295	
13.2	145	195	245	130	180	210	210	275	325	95	130	145	
M		TN6010			TN6025			TN7110			THM		
	14.1	295	390	490	195	245	295				195	245	295
	14.2	245	325	390	160	195	245				160	195	245
	14.3	180	245	310	130	160	180				130	160	180
14.4	145	195	245	95	130	145				95	130	145	
K		TN6010			TN6025			TN7110			THM		
	15	455	555	655	225	295	325	620	790	980	225	295	325
	16	325	425	520	160	210	260	520	650	820	160	210	260
	17	390	490	590	195	225	260	590	750	920	195	225	260
	18	295	390	490	130	180	225	390	560	720	130	180	225
	19	490	590	685	260	310	360	620	790	980	260	310	360
20	360	455	555	195	245	295	590	750	920	195	245	295	
N		TN6010			TN6025			TN7110			THM		
	21	1965	2460	2950	1965	2460	2950				1965	2460	2950
	22	1640	2130	2620	1640	2130	2620				1640	2130	2620
	23	1965	2460	2950	1965	2460	2950				1965	2460	2950
	24	1640	2130	2620	1640	2130	2620				1640	2130	2620
	25	750	980	1210	750	980	1210				750	980	1210
	26	490	655	820	490	655	820				490	655	820
	27	490	655	820	490	655	820				490	655	820
	28	360	455	555	360	455	555				360	455	555
	29	195	260	325	195	260	325				195	260	325
	30	260	325	390	260	325	390				260	325	390
S		TN6010			TN6025			TN7110			THM		
	31	120	145	180	85	120	145				85	120	145
	32	95	115	145	65	95	115				65	95	115
	33	75	90	115	55	75	90				55	75	90
	34	45	55	80	35	45	55				35	45	55
	35	50	55	80	35	50	55				35	50	55
	36	195	235	260	135	195	235				135	195	235
	37	95	115	145	65	95	115				65	95	115

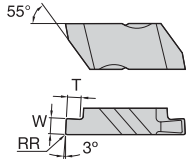

● first choice
○ alternate choice

P	●	●	●	●
M	●	●	○	○
K	●	●	○	○
N	○	○	○	○
S	○	○	○	○
H	○	○	○	○

■ NG

catalog number	W		Ap max		RR		T		insert size	TN6010	TN6025	TN7110	THM
	mm	in	mm	in	mm	in	mm	in					
Right hand													
NG2031R	0,79	.031	—	—	0,09	.0035	1,27	.050	2	●	●	●	●
NG2041R	1,04	.041	—	—	0,09	.0035	1,27	.050	2		●		
NG2058R	1,47	.058	—	—	0,19	.0075	1,27	.050	2		●		
NG2062R	1,58	.062	—	—	0,19	.0075	2,79	.110	2	●	●	●	●
NG3047R	1,19	.047	—	—	0,19	.0075	1,91	.075	3	●	●	●	●
NG3062R	1,58	.062	—	—	0,19	.0075	2,39	.094	3	●	●	●	●
NG3094R	2,39	.094	—	—	0,19	.0075	3,81	.150	3	●	●	●	●
NG3125R	3,18	.125	—	—	0,19	.0075	3,81	.150	3	●	●	●	●
NG4250R	6,35	.250	—	—	0,57	.0225	6,35	.250	4	●	●	●	●
Left hand													
NG2031L	0,79	.031	—	—	0,09	.0035	1,27	.050	2		●		
NG2058L	1,47	.058	—	—	0,19	.0075	1,27	.050	2		●		
NG2062L	1,58	.062	—	—	0,19	.0075	2,79	.110	2		●		
NG3047L	1,19	.047	—	—	0,19	.0075	1,91	.075	3	●	●	●	●
NG3062L	1,58	.062	—	—	0,19	.0075	2,39	.094	3	●	●	●	●
NG3094L	2,39	.094	—	—	0,19	.0075	3,81	.150	3	●	●	●	●
NG3125L	3,18	.125	—	—	0,19	.0075	3,81	.150	3	●	●	●	●
NG4250L	6,35	.250	—	—	0,57	.0225	6,35	.250	4	●	●	●	●
NG5M500L	5,00	.197	—	—	0,32	.0125	9,52	.375	5		●		

NOTE: Right-hand insert shown; left-hand insert is mirror image.

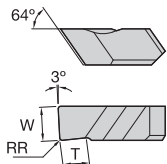

■ NG-1L

catalog number	W		Ap max		RR		T		insert size	cutting edges	TN6010	TN6025	TN7110	THM
	mm	in	mm	in	mm	in	mm	in						
Left hand														
NG1047L	1,19	.047	—	—	0,19	.0075	1,91	.075	1	1		●		
NG1062L	1,58	.062	—	—	0,19	.0075	1,91	.075	1	1		●		
NG1094L	2,39	.094	—	—	0,19	.0075	1,91	.075	1	1		●		

NOTE: Width tolerance is +/- .003" (+/- 0,076mm) on NG-1L inserts.

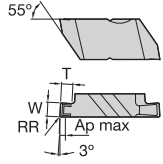

● first choice
○ alternate choice

P	●	●	●	●
M	●	●	○	○
K	●	●	○	○
N	○	○	○	●
S	●	●	○	●
H	○	○	○	○

■ NG-K

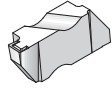

catalog number	W		Ap max		RR		T		insert size	TN6010	TN6025	TN7110	THM
	mm	in	mm	in	mm	in	mm	in					
Right hand NG2M050RK	0,50	.020	0,64	.025	0,09	.0035	0,64	.025	2	●	●		
NG2031RK	0,79	.031	0,76	.030	0,09	.0035	1,27	.050	2	●	●		
NG2M080RK	0,80	.032	0,76	.030	0,09	.0035	1,27	.050	2	●	●		
NG2M100RK	1,00	.039	0,76	.030	0,09	.0035	1,27	.050	2	●	●		
NG2047RK	1,19	.047	0,76	.030	0,09	.0035	1,27	.050	2	●	●		
NG2M120RK	1,20	.047	0,76	.030	0,09	.0035	1,27	.050	2	●	●		
NG2M140RK	1,40	.055	0,76	.030	0,09	.0035	1,27	.050	2	●	●		
NG2M150RK	1,50	.059	1,09	.043	0,19	.0075	2,79	.110	2	●	●		
NG2062RK	1,58	.062	1,09	.043	0,19	.0075	2,79	.110	2	●	●		
NG2M170RK	1,70	.067	1,09	.043	0,19	.0075	2,79	.110	2	●	●		
NG2M175RK	1,75	.069	1,09	.043	0,19	.0075	2,79	.110	2	●	●		
NG2M195RK	1,95	.077	1,09	.043	0,19	.0075	2,79	.110	2	●	●		
NG2M200RK	2,00	.079	1,09	.043	0,19	.0075	2,79	.110	2	●	●		
NG2M220RK	2,20	.087	1,09	.043	0,19	.0075	2,79	.110	2	●	●		
NG2M225RK	2,25	.088	1,09	.043	0,19	.0075	2,79	.110	2	●	●		
NG2094RK	2,39	.094	1,09	.043	0,19	.0075	2,79	.110	2	●	●		
NG2M250RK	2,50	.098	1,09	.043	0,19	.0075	2,79	.110	2	●	●		
NG2M275RK	2,75	.108	1,09	.043	0,19	.0075	2,79	.110	2	●	●		
NG2M300RK	3,00	.118	1,09	.043	0,19	.0075	2,79	.110	2	●	●		
NG2125RK	3,18	.125	1,09	.043	0,19	.0075	2,79	.110	2	●	●		
NG2M325RK	3,25	.128	1,09	.043	0,19	.0075	2,79	.110	2	●	●		
NG3M100RK	1,00	.039	0,76	.030	0,19	.0075	1,91	.075	3	●	●		
NG3047RK	1,19	.047	0,76	.030	0,19	.0075	1,91	.075	3	●	●		
NG3M120RK	1,20	.047	0,76	.030	0,19	.0075	1,91	.075	3	●	●		
NG3M150RK	1,50	.059	1,02	.040	0,19	.0075	2,39	.094	3	●	●	●	
NG3062RK	1,58	.062	1,02	.040	0,19	.0075	2,39	.094	3	●	●	●	
NG3M175RK	1,75	.069	1,02	.040	0,19	.0075	2,39	.094	3	●	●	●	
NG3072RK	1,83	.072	1,02	.040	0,19	.0075	2,39	.094	3	●	●	●	
NG3078RK	1,98	.078	1,02	.040	0,19	.0075	2,39	.094	3	●	●	●	
NG3M200RK	2,00	.079	1,02	.040	0,19	.0075	2,39	.094	3	●	●	●	
NG3M220RK	2,20	.087	1,02	.040	0,19	.0075	2,39	.094	3	●	●	●	
NG3M225RK	2,25	.088	1,02	.040	0,19	.0075	2,39	.094	3	●	●	●	
NG3094RK	2,39	.094	1,02	.040	0,19	.0075	3,81	.150	3	●	●	●	
NG3M250RK	2,50	.098	1,02	.040	0,19	.0075	3,81	.150	3	●	●	●	
NG3M275RK	2,75	.108	1,02	.040	0,19	.0075	3,81	.150	3	●	●	●	
NG3M300RK	3,00	.118	1,02	.040	0,19	.0075	3,81	.150	3	●	●	●	
NG3125RK	3,18	.125	1,02	.040	0,19	.0075	3,81	.150	3	●	●	●	
NG3M320RK	3,20	.126	1,02	.040	0,19	.0075	3,81	.150	3	●	●	●	
NG3M325RK	3,25	.128	1,02	.040	0,19	.0075	3,81	.150	3	●	●	●	
NG3M350RK	3,50	.138	2,92	.115	0,32	.0125	3,81	.150	3	●	●	●	
NG3156RK	3,96	.156	2,92	.115	0,19	.0075	3,81	.150	3	●	●	●	

(continued)

(continued)

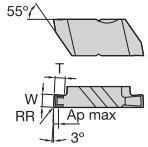

● first choice
○ alternate choice

P	●	●	●	●
M	●	●	○	○
K	●	●	○	○
N	○	○	○	○
S	○	○	○	○
H	○	○	○	○

■ NG-K

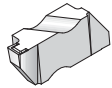

catalog number	W		Ap max		RR		T		insert size	TNG610	TNG625	TNG710	THM
	mm	in	mm	in	mm	in	mm	in					
NG3M400RK	4,00	.158	2,92	.115	0,32	.0125	3,81	.150	3	●	●	●	
NG3M425RK	4,25	.167	2,92	.115	0,32	.0125	3,81	.150	3	●	●	○	
NG3M450RK	4,50	.177	2,92	.115	0,32	.0125	3,81	.150	3	●	●	○	
NG3189RK	4,80	.189	2,92	.115	0,57	.0225	3,81	.150	3	●	●	○	
NG4M300RK	3,00	.118	1,02	.040	0,19	.0075	3,81	.150	4	●	●	○	
NG4125RK	3,18	.125	1,02	.040	0,19	.0075	3,81	.150	4	●	●	○	
NG4M350RK	3,50	.138	2,92	.115	0,57	.0225	6,35	.250	4	●	●	○	
NG4M400RK	4,00	.158	2,92	.115	0,57	.0225	6,35	.250	4	●	●	○	
NG4M450RK	4,50	.177	2,92	.115	0,57	.0225	6,35	.250	4	●	●	○	
NG4189RK	4,80	.189	2,92	.115	0,57	.0225	6,35	.250	4	●	●	○	
NG4M500RK	5,00	.197	2,92	.115	0,32	.0125	6,35	.250	4	●	●	○	
NG4M550RK	5,50	.217	3,81	.150	0,57	.0225	6,35	.250	4	●	●	○	
NG4M600RK	6,00	.236	3,81	.150	0,57	.0225	6,35	.250	4	●	●	○	
NG4250RK	6,35	.250	3,81	.150	0,57	.0225	6,35	.250	4	●	●	○	
Left hand													
NG2M050LK	0,50	.020	0,64	.025	0,09	.0035	0,64	.025	2	●	●	○	
NG2031LK	0,79	.031	0,76	.030	0,09	.0035	1,27	.050	2	●	●	○	
NG2M080LK	0,80	.032	0,76	.030	0,09	.0035	1,27	.050	2	●	●	○	
NG2M100LK	1,00	.039	0,76	.030	0,09	.0035	1,27	.050	2	●	●	○	
NG2047LK	1,19	.047	0,76	.030	0,09	.0035	1,27	.050	2	●	●	○	
NG2M120LK	1,20	.047	0,76	.030	0,09	.0035	1,27	.050	2	●	●	○	
NG2M140LK	1,40	.055	0,76	.030	0,09	.0035	1,27	.050	2	●	●	○	
NG2M150LK	1,50	.059	1,09	.043	0,19	.0075	2,79	.110	2	●	●	○	
NG2062LK	1,58	.062	1,09	.043	0,19	.0075	2,79	.110	2	●	●	○	
NG2M170LK	1,70	.067	1,09	.043	0,19	.0075	2,79	.110	2	●	●	○	
NG2M175LK	1,75	.069	1,09	.043	0,19	.0075	2,79	.110	2	●	●	○	
NG2M195LK	1,95	.077	1,09	.043	0,19	.0075	2,79	.110	2	●	●	○	
NG2M200LK	2,00	.079	1,09	.043	0,19	.0075	2,79	.110	2	●	●	○	
NG2M220LK	2,20	.087	1,09	.043	0,19	.0075	2,79	.110	2	●	●	○	
NG2M225LK	2,25	.088	1,09	.043	0,19	.0075	2,79	.110	2	●	●	○	
NG2094LK	2,39	.094	1,09	.043	0,19	.0075	2,79	.110	2	●	●	○	
NG2M250LK	2,50	.098	1,09	.043	0,19	.0075	2,79	.110	2	●	●	○	
NG2M275LK	2,75	.108	1,09	.043	0,19	.0075	2,79	.110	2	●	●	○	
NG2M300LK	3,00	.118	1,09	.043	0,19	.0075	2,79	.110	2	●	●	○	
NG2125LK	3,18	.125	1,09	.043	0,19	.0075	2,79	.110	2	●	●	○	
NG2M325LK	3,25	.128	1,09	.043	0,19	.0075	2,79	.110	2	●	●	○	
NG3M100LK	1,00	.039	0,76	.030	0,19	.0075	1,91	.075	3	●	●	○	
NG3047LK	1,19	.047	0,76	.030	0,19	.0075	1,91	.075	3	●	●	○	
NG3M120LK	1,20	.047	0,76	.030	0,19	.0075	1,91	.075	3	●	●	○	
NG3M150LK	1,50	.059	1,02	.040	0,19	.0075	2,39	.094	3	●	●	○	
NG3062LK	1,58	.062	1,02	.040	0,19	.0075	2,39	.094	3	●	●	○	
NG3M175LK	1,75	.069	1,02	.040	0,19	.0075	2,39	.094	3	●	●	○	

(continued)

Grooving, Cut-Off, and Turning • TopGroove

(continued)

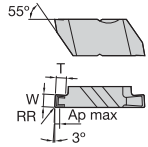

● first choice
○ alternate choice

P	●	●	●	●
M	●	●	○	○
K	●	●	○	○
N	○	○	○	●
S	●	●	○	●
H	○	○	○	○

■ NG-K

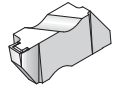

catalog number	W		Ap max		RR		T		insert size	TN6010	TN6025	TN7110	THM
	mm	in	mm	in	mm	in	mm	in					
NG3072LK	1,83	.072	1,02	.040	0,19	.0075	2,39	.094	3	●	●	○	○
NG3078LK	1,98	.078	1,02	.040	0,19	.0075	2,39	.094	3	●	●	○	○
NG3M200LK	2,00	.079	1,02	.040	0,19	.0075	2,39	.094	3	●	●	○	○
NG3M220LK	2,20	.087	1,02	.040	0,19	.0075	2,39	.094	3	●	●	○	○
NG3M225LK	2,25	.088	1,02	.040	0,19	.0075	2,39	.094	3	●	●	○	○
NG3094LK	2,39	.094	1,02	.040	0,19	.0075	3,81	.150	3	●	●	○	○
NG3M250LK	2,50	.098	1,02	.040	0,19	.0075	3,81	.150	3	●	●	○	○
NG3M275LK	2,75	.108	1,02	.040	0,19	.0075	3,81	.150	3	●	●	○	○
NG3M300LK	3,00	.118	1,02	.040	0,19	.0075	3,81	.150	3	●	●	○	○
NG3125LK	3,18	.125	1,02	.040	0,19	.0075	3,81	.150	3	●	●	○	○
NG3M320LK	3,20	.126	1,02	.040	0,19	.0075	3,81	.150	3	●	●	○	○
NG3M325LK	3,25	.128	1,02	.040	0,19	.0075	3,81	.150	3	●	●	○	○
NG3M350LK	3,50	.138	2,92	.115	0,32	.0125	3,81	.150	3	●	●	○	○
NG3156LK	3,96	.156	2,92	.115	0,19	.0075	3,81	.150	3	●	●	○	○
NG3M400LK	4,00	.158	2,92	.115	0,32	.0125	3,81	.150	3	●	●	○	○
NG3M425LK	4,25	.167	2,92	.115	0,32	.0125	3,81	.150	3	●	●	○	○
NG3M450LK	4,50	.177	2,92	.115	0,32	.0125	3,81	.150	3	●	●	○	○
NG3189LK	4,80	.189	2,92	.115	0,57	.0225	3,81	.150	3	●	●	○	○
NG4M300LK	3,00	.118	1,02	.040	0,19	.0075	3,81	.150	4	●	●	○	○
NG4125LK	3,18	.125	1,02	.400	0,19	.0075	3,81	.150	4	●	●	○	○
NG4M350LK	3,50	.138	2,92	.115	0,57	.0225	6,35	.250	4	●	●	○	○
NG4M400LK	4,00	.158	2,92	.115	0,57	.0225	6,35	.250	4	●	●	○	○
NG4M450LK	4,50	.177	2,92	.115	0,57	.0225	6,35	.250	4	●	●	○	○
NG4189LK	4,80	.189	2,92	.115	0,57	.0225	6,35	.250	4	●	●	○	○
NG4M500LK	5,00	.197	2,92	.115	0,32	.0125	6,35	.250	4	●	●	○	○
NG4M550LK	5,50	.217	3,81	.150	0,57	.0225	6,35	.250	4	●	●	○	○
NG4M600LK	6,00	.236	3,81	.150	0,57	.0225	6,35	.250	4	●	●	○	○
NG4250LK	6,35	.250	3,81	.150	0,57	.0225	6,35	.250	4	●	●	○	○

Grooving, Cut-Off, and Turning • TopGroove

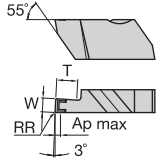

● first choice
○ alternate choice

P	●	●	●	●
M	●	●	○	○
K	●	●	○	○
N	○	○	○	●
S	○	○	○	●
H	○	○	○	○

■ **NGD-K**

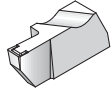

catalog number	W		Ap max		RR		T		insert size	cutting edges	TN6010	TN6025	TN7110	THM
	mm	in	mm	in	mm	in	mm	in						
Right hand														
NGD2M150RK	1,50	.059	1,09	.043	0,19	.0075	4,06	.160	2	1	●	●		
NGD2M200RK	2,00	.079	1,09	.043	0,19	.0075	5,08	.200	2	1	●	●		
NGD2M250RK	2,50	.098	1,09	.043	0,19	.0075	5,08	.200	2	1	●	●		
NGD3062RK	1,58	.062	1,02	.040	0,19	.0075	3,18	.125	3	2	●	●		
NGD3M200RK	2,00	.079	1,02	.040	0,19	.0075	4,06	.160	3	1	●	●		
NGD3094RK	2,39	.094	1,02	.040	0,19	.0075	6,35	.250	3	1	●	●		●
NGD3M250RK	2,50	.098	1,02	.040	0,19	.0075	6,35	.250	3	1	●	●		
NGD3M300RK	3,00	.118	1,02	.040	0,19	.0075	6,35	.250	3	1	●	●		
NGD3125RK	3,18	.125	1,02	.040	0,19	.0075	6,35	.250	3	1	●	●		
NGD3M350RK	3,50	.138	2,92	.115	0,32	.0125	6,35	.250	3	1	●	●		
NGD3M400RK	4,00	.157	2,92	.115	0,32	.0125	6,35	.250	3	1	●	●		
NGD3189RK	4,80	.189	2,92	.115	0,57	.0225	6,35	.250	3	1	●	●		
NGD4125RK	3,18	.125	1,02	.040	0,19	.0075	6,35	.250	4	2	●	●		
NGD4M400RK	4,00	.157	2,92	.115	0,57	.0225	9,53	.375	4	1	●	●		
NGD4M450RK	4,50	.177	2,92	.115	0,57	.0225	12,70	.500	4	1	●	●		
NGD4189RK	4,80	.189	2,92	.115	0,57	.0225	9,53	.375	4	1	●	●		
NGD4M500RK	5,00	.197	2,92	.115	0,57	.0225	12,70	.500	4	1	●	●		
NGD4M550RK	5,50	.217	3,81	.150	0,57	.0225	12,70	.500	4	1	●	●		
NGD4250RK	6,35	.250	3,81	.150	0,57	.0225	12,70	.500	4	1	●	●		
Left hand														
NGD2M150LK	1,50	.059	1,09	.043	0,19	.0075	4,06	.160	2	1	●	●		
NGD2M200LK	2,00	.079	1,09	.043	0,19	.0075	5,08	.200	2	1	●	●		
NGD2M250LK	2,50	.098	1,09	.043	0,19	.0075	5,08	.200	2	1	●	●		
NGD3062LK	1,58	.062	1,02	.040	0,19	.0075	3,18	.125	3	2	●	●		
NGD3M200LK	2,00	.079	1,02	.040	0,19	.0075	4,06	.160	3	1	●	●		
NGD3094LK	2,39	.094	1,02	.040	0,19	.0075	6,35	.250	3	1	●	●		●
NGD3M250LK	2,50	.098	1,02	.040	0,19	.0075	6,35	.250	3	1	●	●		
NGD3M300LK	3,00	.118	1,02	.040	0,19	.0075	6,35	.250	3	1	●	●		
NGD3125LK	3,18	.125	1,02	.040	0,19	.0075	6,35	.250	3	1	●	●		
NGD3M350LK	3,50	.138	2,92	.115	0,32	.0125	6,35	.250	3	1	●	●		
NGD3M400LK	4,00	.157	2,92	.115	0,32	.0125	6,35	.250	3	1	●	●		
NGD3189LK	4,80	.189	2,92	.115	0,57	.0225	6,35	.250	3	1	●	●		
NGD4125LK	3,18	.125	1,02	.040	0,19	.0075	6,35	.250	4	2	●	●		
NGD4M400LK	4,00	.157	2,92	.115	0,57	.0225	9,53	.375	4	1	●	●		
NGD4M450LK	4,50	.177	2,92	.115	0,57	.0225	12,70	.500	4	1	●	●		
NGD4189LK	4,80	.189	2,92	.115	0,57	.0225	9,53	.375	4	1	●	●		
NGD4M500LK	5,00	.197	2,92	.115	0,57	.0225	12,70	.500	4	1	●	●		
NGD4M550LK	5,50	.217	3,81	.150	0,57	.0225	12,70	.500	4	1	●	●		
NGD4250LK	6,35	.250	3,81	.150	0,57	.0225	12,70	.500	4	1	●	●		

NOTE: Right-hand insert shown; left-hand insert is mirror image.

Grooving, Cut-Off, and Turning • TopGroove

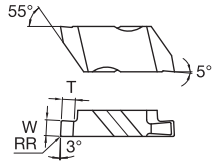

● first choice
○ alternate choice

P	●	●	●	●
M	●	●	○	○
K	●	●	○	○
N	○	○	○	○
S	●	●	○	○
H	○	○	○	○

■ **NGP**

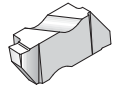

catalog number	W		Ap max		RR		T		insert size	TNG010	TNG025	TN7110	THM
	mm	in	mm	in	mm	in	mm	in					
Right hand													
NGP2M150R	1,50	.059	—	—	0,19	.0075	2,79	.110	2	●			●
NGP2062R	1,58	.062	—	—	0,19	.0075	2,79	.110	2	●			
NGP2M200R	2,00	.079	—	—	0,19	.0075	2,79	.110	2	●			●
NGP2M250R	2,50	.098	—	—	0,19	.0075	2,79	.110	2	●			●
NGP2M300R	3,00	.118	—	—	0,19	.0075	2,79	.110	2	●			●
NGP3M150R	1,50	.059	—	—	0,19	.0075	1,90	.075	3	●			●
NGP3M200R	2,00	.079	—	—	0,19	.0075	2,79	.110	3	●			●
NGP3M250R	2,50	.098	—	—	0,19	.0075	3,81	.150	3	●			●
NGP3M300R	3,00	.118	—	—	0,19	.0075	3,81	.150	3	●			●
Left hand													
NGP2M150L	1,50	.059	—	—	0,19	.0075	2,79	.110	2	●			●
NGP2062L	1,58	.062	—	—	0,19	.0075	2,79	.110	2	●			
NGP2M200L	2,00	.079	—	—	0,19	.0075	2,79	.110	2	●			●
NGP2M250L	2,50	.098	—	—	0,19	.0075	2,79	.110	2	●			●
NGP2M300L	3,00	.118	—	—	0,19	.0075	2,79	.110	2	●			●
NGP3M150L	1,50	.059	—	—	0,19	.0075	1,90	.075	3	●			●
NGP3M200L	2,00	.079	—	—	0,19	.0075	2,79	.110	3	●			●
NGP3M250L	2,50	.098	—	—	0,19	.0075	3,81	.150	3	●			●
NGP3M300L	3,00	.118	—	—	0,19	.0075	3,81	.150	3	●			●

NOTE: Right-hand insert shown; left-hand insert is mirror image.

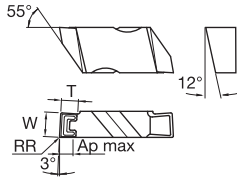

● first choice
○ alternate choice

P	●	●	●	●
M	●	●	○	○
K	●	●	○	○
N	○	○	○	●
S	○	○	○	○
H	○	○	○	○

■ **NF-K**

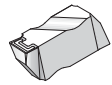

catalog number	W		Ap max		RR		T		insert size	TN6010	TN6025	TN7110	THM
	mm	in	mm	in	mm	in	mm	in					
Right hand													
NF3M200RK	2,00	.079	1,02	.040	0,19	.0075	1,78	.070	3		●		
NF3M300RK	3,00	.118	1,02	.040	0,19	.0075	3,81	.150	3		●		
NF3125RK	3,18	.125	1,02	.040	0,19	.0075	3,81	.150	3		●		
Left hand													
NF3M200LK	2,00	.079	1,02	.040	0,19	.0075	1,78	.070	3		●		
NF3M300LK	3,00	.118	1,02	.040	0,19	.0075	3,81	.150	3		●		
NF3125LK	3,18	.125	1,02	.040	0,19	.0075	3,81	.150	3		●		
NF3156LK	3,96	.156	2,92	.115	0,19	.0075	3,81	.150	3		●		

NOTE: Right-hand insert shown; left-hand insert is mirror image.

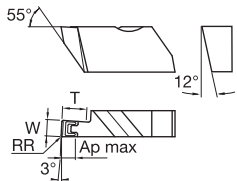

■ **NFD-K**

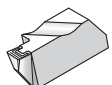

catalog number	W		Ap max		RR		T		insert size	cutting edges	TN6010	TN6025	TN7110	THM
	mm	in	mm	in	mm	in	mm	in						
Right hand														
NFD3M300RK	3,00	.118	1,02	.040	0,19	.0075	6,35	.250	3	1		●		
NFD3125RK	3,18	.125	1,02	.040	0,19	.0075	6,35	.250	3	1		●		
NFD4189RK	4,80	.189	2,92	.115	0,57	.0225	9,53	.375	4	1		●		
Left hand														
NFD4250RK	6,35	.250	3,81	.150	0,57	.0225	12,70	.500	4	1		●		
NFD3M300LK	3,00	.118	1,02	.040	0,19	.0075	6,35	.250	3	1		●		
NFD3125LK	3,18	.125	1,02	.040	0,19	.0075	6,35	.250	3	1		●		
NFD4189LK	4,80	.189	2,92	.115	0,57	.0225	9,53	.375	4	1		●		

NOTE: Right-hand insert shown; left-hand insert is mirror image.

Grooving, Cut-Off, and Turning • TopGroove

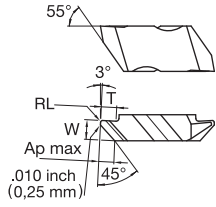

NP-K

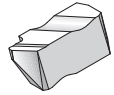

catalog number	W		Ap max		RL		T		insert size	TN6010	TN6025	TN7110	THM
	mm	in	mm	in	mm	in	mm	in					
Right hand NP2002RK	3,68	.145	—	—	0,25	.0100	2,79	.110	2	●	●		
NP3002RK	4,83	.190	—	—	0,25	.0100	5,08	.200	3	●	●		
NP3012RK	4,83	.190	—	—	0,25	.0100	5,08	.200	3		●		

NOTE: Right-hand insert shown; left-hand insert is mirror image.
Width tolerance is +/- .005" (+/- 0,13mm).

● first choice
○ alternate choice

P	●	●	●	●
M	●	●	○	○
K	●	●	○	○
N	○	○	○	●
S	●	●	○	●
H	○	○	○	○

Grooving, Cut-Off, and Turning • TopGroove

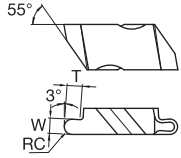

NR

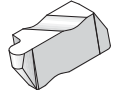

catalog number	W		Ap max		RC		T		insert size	TN6010	TN6025	TN7110	THM
	mm	in	mm	in	mm	in	mm	in					
Right hand NR2M050R	1,00	.039	—	—	0,50	.0197	1,27	.050	2	●	●	●	
NR2M075R	1,50	.059	—	—	0,75	.0295	2,79	.110	2	●	●	●	
NR2031R	1,58	.062	—	—	0,79	.0310	2,79	.110	2	●	●		
NR2M100R	2,00	.079	—	—	1,00	.0394	2,79	.110	2	●	●	●	
NR2047R	2,39	.094	—	—	1,19	.0470	2,79	.110	2		●		
NR2M125R	2,50	.098	—	—	1,25	.0492	2,79	.110	2	●	●	●	
NR2M150R	3,00	.118	—	—	1,50	.0591	2,79	.110	2	●	●	●	
NR2M175R	3,50	.138	—	—	1,75	.0689	2,79	.110	2	●	●	●	
NR3031R	1,58	.062	—	—	0,79	.0310	2,39	.094	3	●	●		●
NR3M100R	2,00	.079	—	—	1,00	.0394	2,39	.094	3	●	●	●	
NR3047R	2,39	.094	—	—	1,19	.0470	3,81	.150	3	●	●		●
NR3M125R	2,50	.098	—	—	1,25	.0492	3,81	.150	3	●	●	●	
NR3M150R	3,00	.118	—	—	1,50	.0591	3,81	.150	3	●	●	●	
NR3062R	3,18	.125	—	—	1,59	.0625	3,81	.150	3	●	●		●
NR3M175R	3,50	.138	—	—	1,75	.0689	3,81	.150	3	●	●	●	
NR3M200R	4,00	.157	—	—	2,00	.0787	3,81	.150	3	●	●	●	
NR3M225R	4,50	.177	—	—	2,25	.0886	3,81	.150	3	●	●	●	
NR3094R	4,78	.188	—	—	2,39	.0940	3,81	.150	3	●	●		
NR4M200R	4,00	.157	—	—	2,00	.0787	6,35	.250	4	●	●	●	
NR4M225R	4,50	.177	—	—	2,25	.0886	6,35	.250	4	●	●	●	
NR4M250R	5,00	.197	—	—	2,50	.0984	6,35	.250	4	●	●	●	
NR4125R	6,35	.250	—	—	3,18	.1250	6,35	.250	4	●	●		

NOTE: Right-hand insert shown; left-hand insert is mirror image.

(continued)

(continued)

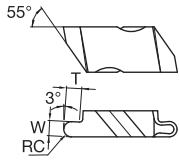

● first choice
○ alternate choice

P	●	●	●	●
M	●	●	○	○
K	●	●	○	○
N	○	○	○	●
S	○	○	○	○
H	○	○	○	○

■ NR

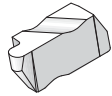

catalog number	W		Ap max		RC		T		insert size	TN6010	TN6025	TN7110	THM
	mm	in	mm	in	mm	in	mm	in					
Left hand													
NR2M050L	1,00	.039	—	—	0,50	.0197	1,27	.050	2	●	●	●	
NR2M075L	1,50	.059	—	—	0,75	.0295	2,79	.110	2	●	●	●	
NR2031L	1,58	.062	—	—	0,79	.0310	2,79	.110	2	●	●	●	
NR2M100L	2,00	.079	—	—	1,00	.0394	2,79	.110	2	●	●	●	
NR2047L	2,39	.094	—	—	1,19	.0470	2,79	.110	2	●	●	●	
NR2M125L	2,50	.098	—	—	1,25	.0492	2,79	.110	2	●	●	●	
NR2M150L	3,00	.118	—	—	1,50	.0591	2,79	.110	2	●	●	●	
NR2M175L	3,50	.138	—	—	1,75	.0689	2,79	.110	2	●	●	●	
NR3031L	1,58	.062	—	—	0,79	.0310	2,39	.094	3	●	●	●	●
NR3M100L	2,00	.079	—	—	1,00	.0394	2,39	.094	3	●	●	●	●
NR3047L	2,39	.094	—	—	1,19	.0470	3,81	.150	3	●	●	●	●
NR3M125L	2,50	.098	—	—	1,25	.0492	3,81	.150	3	●	●	●	●
NR3M150L	3,00	.118	—	—	1,50	.0591	3,81	.150	3	●	●	●	●
NR3062L	3,18	.125	—	—	1,59	.0625	3,81	.150	3	●	●	●	●
NR3M175L	3,50	.138	—	—	1,75	.0689	3,81	.150	3	●	●	●	●
NR3M200L	4,00	.157	—	—	2,00	.0787	3,81	.150	3	●	●	●	●
NR3M225L	4,50	.177	—	—	2,25	.0886	3,81	.150	3	●	●	●	●
NR3094L	4,78	.188	—	—	2,39	.0940	3,81	.150	3	●	●	●	●
NR4M200L	4,00	.157	—	—	2,00	.0787	6,35	.250	4	●	●	●	●
NR4M225L	4,50	.177	—	—	2,25	.0886	6,35	.250	4	●	●	●	●
NR4M250L	5,00	.197	—	—	2,50	.0984	6,35	.250	4	●	●	●	●
NR4125L	6,35	.250	—	—	3,18	.1250	6,35	.250	4	●	●	●	●

Grooving, Cut-Off, and Turning • TopGroove

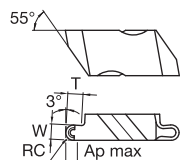

● first choice
○ alternate choice

P	●	●	●	●
M	●	●	○	○
K	●	●	○	○
N	○	○	○	●
S	●	●	○	●
H	○	○	○	○

NR-K

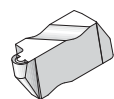

catalog number	W		Ap max		RC		T		insert size	TN6010	TN6025	TN7110	THM
	mm	in	mm	in	mm	in	mm	in					
Right hand													
NR3031RK	1,58	.062	1,98	.078	0,79	.0310	2,39	.094	3	●	●		
NR3047RK	2,39	.094	1,91	.075	1,19	.0470	3,81	.150	3	●	●		
NR3062RK	3,18	.125	2,92	.115	1,59	.0625	3,81	.150	3	●	●		
NR3078RK	3,96	.156	2,54	.100	1,98	.0780	3,81	.150	3	●	●		
NR4062RK	3,18	.125	2,92	.115	1,59	.0625	3,81	.150	4	●	●		
NR4094RK	4,78	.188	3,81	.150	2,39	.0940	6,35	.250	4	●	●		
NR4125RK	6,35	.250	3,81	.150	3,18	.1250	6,35	.250	4	●	●		
Left hand													
NR3031LK	1,58	.062	1,98	.078	0,79	.0310	2,39	.094	3	●	●		
NR3047LK	2,39	.094	1,91	.075	1,19	.0470	3,81	.150	3	●	●		
NR3062LK	3,18	.125	2,92	.115	1,59	.0625	3,81	.150	3	●	●		
NR3078LK	3,96	.156	2,54	.100	1,98	.0780	3,81	.150	3	●	●		
NR4062LK	3,18	.125	2,92	.115	1,59	.0625	3,81	.150	4	●	●		
NR4094LK	4,78	.188	3,81	.150	2,39	.0940	6,35	.250	4	●	●		
NR4125LK	6,35	.250	3,81	.150	3,18	.1250	6,35	.250	4	●	●		

NOTE: Right-hand insert shown; left-hand insert is mirror image.

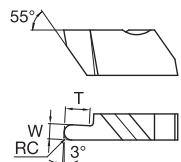

NRD

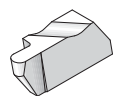

catalog number	W		Ap max		RC		T		insert size	cutting edges	TN6010	TN6025	TN7110	THM
	mm	in	mm	in	mm	in	mm	in						
Right hand														
NRD3031R	1,58	.062	—	—	0,79	.0310	3,18	.125	3	2	●	●		
NRD3062R	3,18	.125	—	—	1,59	.0625	6,35	.250	3	1	●	●		
NRD4062R	3,18	.125	—	—	1,59	.0625	6,35	.250	4	2	●	●		
NRD4125R	6,35	.250	—	—	3,18	.1250	12,70	.500	4	1	●	●		
Left hand														
NRD3031L	1,58	.062	—	—	0,79	.0310	3,18	.125	3	2	●	●		
NRD3062L	3,18	.125	—	—	1,59	.0625	6,35	.250	3	1	●	●		
NRD4062L	3,18	.125	—	—	1,59	.0625	6,35	.250	4	2	●	●		
NRD4125L	6,35	.250	—	—	3,18	.1250	12,70	.500	4	1	●	●		

NOTE: Right-hand insert shown; left-hand insert is mirror image.

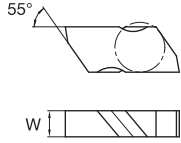

● first choice
○ alternate choice

P	●	●	●	●
M	●	●	○	○
K	●	●	○	○
N	○	○	○	●
S	○	○	○	●
H	○	○	○	○

■ NB

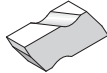
catalog number	W		insert size	TN6010	TN6025	TN7110	THM
	mm	in					
 Right hand NB2R	3,81	.150	2				●
NB3R Left hand	4,95	.195	3				●
NB2L	3,81	.150	2				●
NB3L	4,95	.195	3				●

NOTE: Right-hand insert shown; left-hand insert is mirror image.
NB blanks are designed to allow modification of the W dimension and end-form.
W dimension is provided to indicate maximum possible width.
Available in uncoated grades only.

Grooving, Cut-Off, and Turning • TopGroove

TopGroove Inserts: The Best Platform for Customization

All TopGroove custom order inserts benefit from the superior rigidity of our TopGroove toolholder and clamping system. For added productivity, most custom orders can be incorporated into the double-ended inserts.

Custom orders start with proven WIDIA™ carbide grade technology as the basis for optimizing tool performance. Positive top rake angles are also available in most inserts.

State-of-the-art CAD enables rapid development of your custom insert design. For convenience, a concept drawing is always available to facilitate engineering development of an insert.

There are limitless variations of the flat-top TopGroove design. Additionally, chip control in the most common styles enables true optimization and productivity. WIDIA offers NB- and NBD-style insert blanks as well. These blanks can be end-form ground in your own shop.

Whatever your special grooving requirements may be, WIDIA can provide an effective solution. We have the technical expertise, resources, and commitment to help you develop insert designs that satisfy your metalcutting application demands.

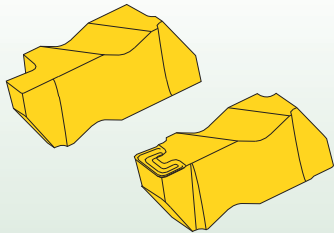

top rake

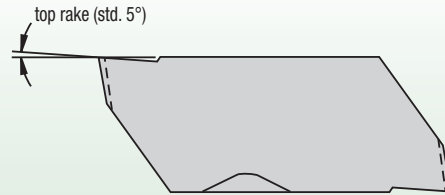

style A

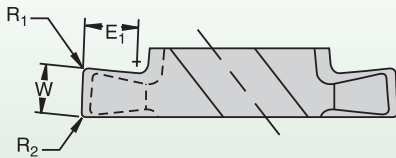

style B1

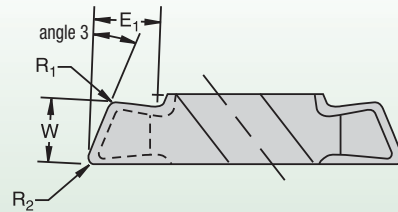

style B2

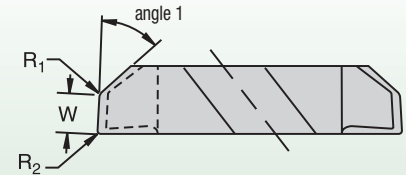

style B3

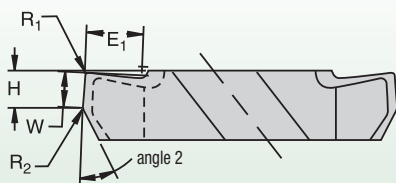

style B4

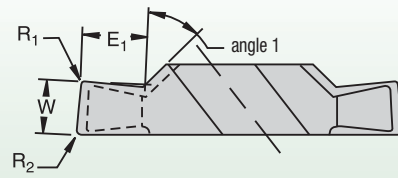

style C1

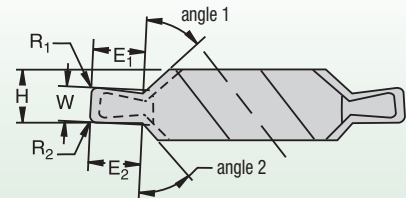

style D

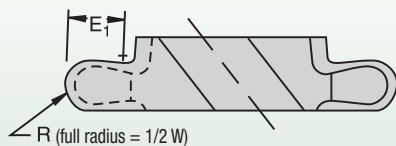

style F

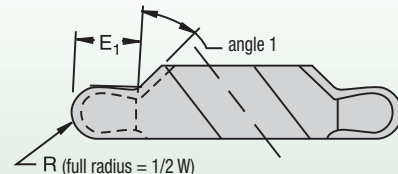

style G

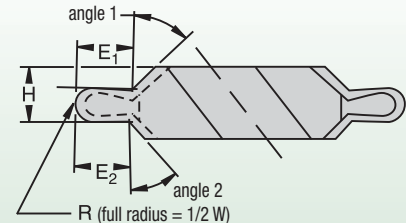

NOTE: Common styles are shown here in right-hand versions. Left-hand versions are also available.

TopGroove™ Grooving Systems

Use this Custom-Order Worksheet to modify an existing product to meet your specifications. If your custom requirements do not fall into these categories, simply contact your WIDIA™ Distributor.

Trust our experienced distributors and WIDIA engineering team to design the best solution for you.

Date

Customer-Specified Dimensions

Style (circle one)

A B1 B2 B3 B4 C1 D F G

Orientation (circle one)

left hand

right hand

Top Rake

Total Width (T)

Cutting Width (W)

Angle 1

Corner Radius 1 (R₁)

Angle 2

Corner Radius 2 (R₂)

Offset (H)

Cutting Depth (E₁)

Other (please specify)

Special Instructions

(please make any necessary notes or sketches in the box at right)

Closest Catalog Standard

Customer

Distributor

Shipping Requirements

Ground Next Day Air 2nd Day Air 3rd Day Air

Attention Distributors: Use this worksheet to collect information for your customer.

■ A-SK Specials

10° positive cutting action

- Grooving
- Face grooving

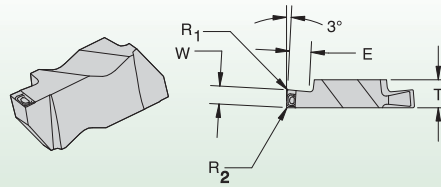

insert catalog number		width range W	corner radii range R ₁ and R ₂	E	T	grades
right hand	left hand					
NG2-R-SK or NF2-R-SK	NG2-L-SK or NF2-L-SK	.026-.056 .057-.135	.000-.007 .003-.013	.050 .110	.150	carbide grades quoted upon request. See page D46.
NG3-R-SK or NF3-R-SK	NG3-L-SK or NF3-L-SK	.042-.067 .068-.076 .077-.094 .095-.105 .106-.125 .126-.134 .135-.156 .157-.174 .184-.196	.003-.013 .005-.020 .005-.030 .005-.020 .005-.030 .005-.020 .005-.030 .008-.018 .018-.028	.094 .094 .150 .150 .150 .150 .150 .150 .150	.195	
NG4-R-SK or NF4-R-SK	NG4-L-SK or NF4-L-SK	.100-.110 .111-.125 .126-.131 .132-.156 .157-.162 .163-.189 .190-.191 .192-.204 .245-.257	.005-.020 .005-.030 .005-.020 .005-.030 .005-.020 .005-.030 .018-.028 .008-.018 .018-.025	.150 .150 .150 .150 .150 .250 .250 .250 .250	.255	

NG-SK, NF-SK, NGD-SK, and NFD-SK inserts may be specially ordered within the specifications listed in the above charts.

Order example: NF3R-SK W=.090, R₁=.010, R₂=.010, grade TN6010.

Unless otherwise specified, a standard tolerance of ±.001" on width (W) will be applied, and a standard tolerance of ±.0025" on radii (R₁ and R₂) will be applied.

If deeper cutting depth (E) is required, please specify. Refer to the application drawing and charts for maximum face groove depths and minimum face groove diameters.

In addition to the guidelines above, full radius face groove inserts may be quoted. Under certain conditions, chip control performance may vary from standard insert styles.

■ A-SK Specials

10° positive cutting action

- Deep grooving
- Deep face grooving

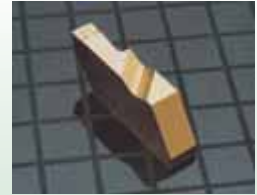
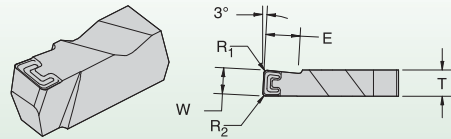

insert catalog number		width range W	corner radii range R ₁ and R ₂	E	T	grades
right hand	left hand					
NGD3-R-SK or NFD3-R-SK	NGD3-L-SK or NFD3-L-SK	.057–.069	.003–.013	.125	.195	carbide grades quoted upon request. See page D46.
		.089–.101*	.003–.013	.250		
		.120–.132*	.003–.013	.250		
		.184–.196*	.018–.028	.250		
NGD4-R-SK or NFD4-R-SK	NG4-L-SK or NF4-L-SK	.120–.132*	.003–.013	.250	.255	
		.180–.196*	.018–.028	.375		
		.245–.257*	.018–.028	.500		

*One cutting edge.

NG-SK, NF-SK, NGD-SK, and NFD-SK inserts may be specially ordered within the specifications listed in the above charts.

Order example: NF3R-SK W=.090,
R₁=.010, R₂=.010, grade TN6010.

Unless otherwise specified, a standard tolerance of ±.001" on width (W) will be applied, and a standard tolerance of ±.0025" on radii (R₁ and R₂) will be applied.

If deeper cutting depth (E) is required, please specify. Refer to the application drawing and charts for maximum face groove depths and minimum face groove diameters.

In addition to the guidelines above, full radius face groove inserts may be quoted. Under certain conditions, chip control performance may vary from standard insert styles.

■ C1-SK Specials

- Groove and chamfer

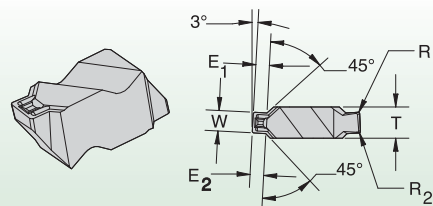







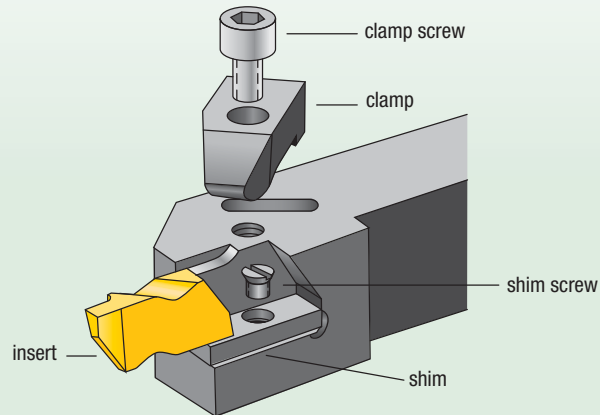



insert catalog number		width range W	corner radii range R ₁ and R ₂	E	T	grades
right hand	left hand					
NB2-R-K	NB2-L-K	.047–.125	.005–.015	.100	.150	carbide grades quoted upon request.
NB3-R-K	NB3-L-K	.094–.170	.005–.025	.150	.195	See page D46.

NOTE: The above insert style is for simultaneous groove and chamfer operations with chip control.

TopGroove Toolholders and Boring Bars



insert size and style	 clamp	 clamp screw	 shim	 shim screw
NG-1L 	CM-109	S-304	—	—
NG-2R	CM-182	S-310	—	—
NG-2L	CM-183	S-310	—	—
NG-2R 	CM-74	S-310	—	—
NG-2L	CM-75	S-310	—	—
NG-3R	CM-184	S-412	—	—
NG-3L	CM-185	S-412	—	—
NG-3R	CM-72	S-412	—	—
NG-3L 	CM-73	S-412	—	—
NG-3R*	CM-78	S-412	—	—
NG-3L*	CM-70	S-412	—	—
NG-4R	CM-72	S-412	SM-420	SL-344
NG-4L 	CM-73	S-412	SM-420	SL-344
NG-5R	CM-80	S-352	—	—
NG-5L 	CM-81	S-352	—	—
NG-6R	CM-120	S-412	SM-416	S-111
NG-6L 	CM-121	S-412	SM-416	S-111
TopGroove relief grooving				
NU-3125R	CM-72	S-412	—	—
NU-3125L	CM-73	S-412	—	—
NU-3125R**	CM-72	S-618	—	—
NU-3125L**	CM-73	S-618	—	—
Utility threading				
NTU-4R	CM-72	S-412	—	—
NTU-4L	CM-73	S-412	—	—

*1" diameter boring head.

**Boring head.

Grooving Tool Failure and Solution Guide

Practical Solutions to Common Grooving Problems

Holder Position for Grooving Operation

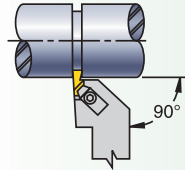

How to Cut a Groove Slightly Wider than the Groove Tool

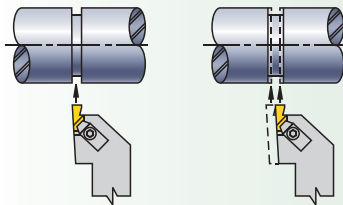

1. Plunge the center of the groove.
2. Plunge each side of the groove to get the specified width. Use a slower feed rate when cutting groove sides.

How to Cut Wider Grooves

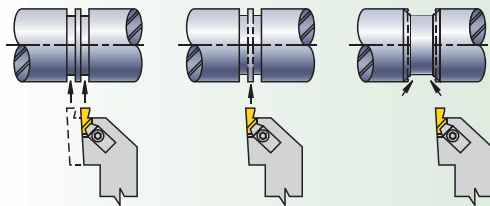

1. Plunge out both sides of groove width.
2. Plunge center area to remove web of material remaining.
3. Plunge both sides of groove at the required angle, using approximately one-half the width of the grooving tool for maximum width of cut.

Finish Turning the Groove

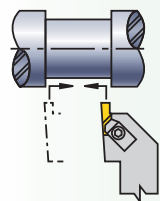

1. Follow recommendations explained above.
2. To avoid insert chipping and to achieve groove wall perpendicularity, follow the tool path outlined here.
3. Use the lightest depth of cut that still enables good chip surface finishing.

problem	solution
burr	<ol style="list-style-type: none"> 1. Ensure tool center height. 2. Use sharp tool (index more often). 3. Use positive rake PVD-coated insert. 4. Use correct grade for workpiece material. 5. Use correct geometry (e.g., positive rake for work-hardening material). 6. Chamfer before grooving. 7. Change tool path.
poor surface finish	<ol style="list-style-type: none"> 1. Increase speed. 2. Use sharp tool (index more often). 3. Dwell tool in bottom 1–3 revolutions (max). 4. Use proper chip control geometry. 5. Increase coolant flow/concentration. 6. Ensure proper setup (overhang, shank size). 7. Use correct geometry (e.g., positive rake for work-hardening material).
groove bottom that is not flat	<ol style="list-style-type: none"> 1. Use sharp tool (index more often). 2. Dwell tool in bottom 1–3 revolutions (max). 3. Reduce tool overhang (increase rigidity). 4. Ensure correct tool alignment. 5. Reduce feed rate at groove bottom. 6. Use a wider insert. 7. Ensure tool center height.
poor chip control	<ol style="list-style-type: none"> 1. Use “K” chip control geometry insert. 2. Use sharp tool (index more often). 3. Increase coolant concentration. 4. Adjust feed rate (usually increase first).
chatter	<ol style="list-style-type: none"> 1. Reduce tool and workpiece overhang. 2. Adjust speed and feed (usually increase first). 3. Ensure center height.
insert chipping	<ol style="list-style-type: none"> 1. Use correct grade for workpiece material. 2. Increase speed. 3. Reduce feed. 4. Use a stronger grade. 5. Increase tool and setup rigidity.
side walls not straight	<ol style="list-style-type: none"> 1. Check tool alignment for square. 2. Use correct insert hand. 3. Reduce workpiece and tool overhang. 4. Use sharp insert (index more often).

Machining Guidelines for Chip Control • Grooving

When the proper cutter diameter is not available, proper cutter positioning will provide positive results.

- Center height of insert should be positioned at the center of the workpiece or up to .005" (0,13mm) above.
- Dwell time in the bottom of the groove (more than three revolutions) is not recommended.
- Chip control is feed rate related and should be adjusted to fit the particular situation. Recommended feed range is .003"–.012" IPR (0,08–0,3 mm/rev).

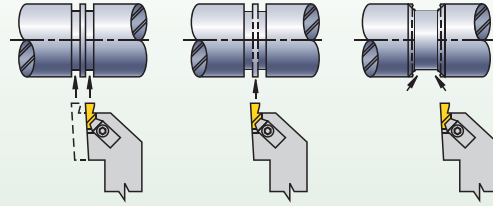

Machining Guidelines for Chip Control • Turning/Profiling

Maximum depth of cut for side cutting (turning/profiling) depends on the material being cut and the width of the tool.

- .031"–.062" (0,79mm–1,6mm) wide insert can cut up to .025" (0,6mm) deep.
- .067"–.128" (1,7mm–3,3mm) wide insert can cut up to .040" (1,0mm) deep.
- .138"–.189" (3,5mm–4,8mm) wide insert can cut up to .080" (2,0mm) deep.
- .197"–.250" (5,0mm–6,35mm) wide insert can cut up to .120" (3,0mm) deep.

Finish Turning the Groove

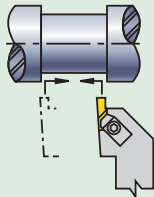

1. Plunge both sides of groove width.
2. Plunge center area to remove web of material remaining.
3. To avoid insert chipping and to achieve groove wall perpendicularity, follow the tool path outlined.
4. Use the lightest depth of cut that still allows good chipbreaking, tool life, and surface finish.

Groove Limits				
insert catalog number	maximum internal groove depth		minimum bore diameter	
	inch	mm	inch	mm
NG-1094L	.075	1,91	.800	20,32
—	.040	1,02	.440	11,18
NG-2031R/L	.050	1,27	.730	18,54
NG-2041R/L	—	—	—	—
NG-2047R/L	—	—	—	—
NG-2058R/L	—	—	—	—
—	.110	2,79	2,500	63,50
NG-2062R/L	.102	2,59	1,750	44,45
NG-2094R/L	.098	2,49	1,500	38,10
NG-2125R/L	.080	2,03	1,000	25,40
—	.055	1,40	.730	18,54
NG-3047R/L	—	—	—	—
NG-3062R/L	.094	2,39	1,750	44,45
NG-3072R/L	.090	2,29	1,625	41,28
NG-3078R/L	.075	1,91	1,375	34,93
NG-3088R/L	—	—	—	—
NG-3094R/L	—	—	—	—
NG-3097R/L	.150	3,81	2,375	60,33
NG-3105R/L	—	—	—	—
NG-3110R/L	.145	3,68	2,125	53,98
NG-3122R/L	—	—	—	—
NG-3125R/L	.138	3,51	1,875	47,63
NG-3142R/L	—	—	—	—
NG-3156R/L	.125	3,18	1,625	41,28
NG-3178R/L	—	—	—	—
NG-3185R/L	.110	2,79	1,375	34,93
NG-3189R/L	—	—	—	—
NG-4125R/L	.150	3,81	2,750	69,85
—	.250	6,35	5,750	146,05
NG-4189R/L	.245	6,22	5,000	127,00
NG-4213R/L	.240	6,10	4,500	114,30
NG-4219R/L	.218	5,54	3,250	82,55
NG-4250R/L	.200	5,08	2,500	63,50

NOTE: The same maximum groove depth and minimum bore diameter values also apply to metric, NG-K (chip control), and NR (full radius) inserts of similar size.

The same internal grooving depth limits are a function of bar clearance versus bore diameters.

Internal Groove Depth versus Bar Interference

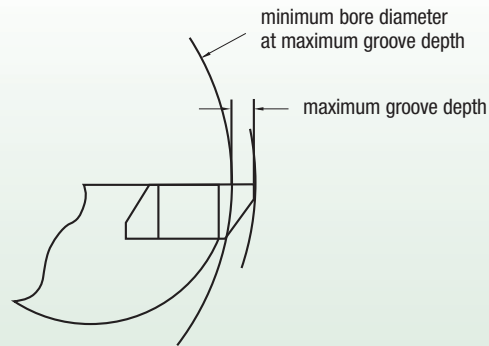

NOTE: Internal grooving depth limits are a function of bar clearance versus bore diameters.

Machining Guidelines for Back Turning/Turning/Profiling

The NP-K-style TopGroove inserts were engineered specifically for back turning on small automatic lathes, but they also find applications for other light turning and profiling operations. For general applications, maximum depth of cut should not exceed .108" (2,74mm) for size 2 inserts or .151" (3,84mm) for size 3 inserts.

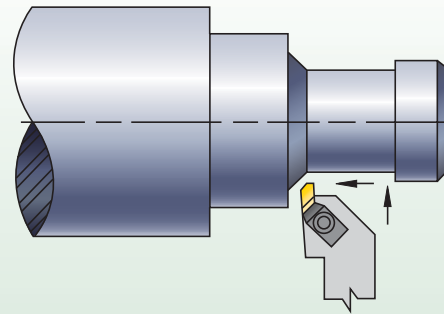

Machining Guidelines for Using TopGroove Deep Grooving Inserts (NGD)

Typically, those NGD- and NRD-style inserts with two cutting edges require no machine offset changes. However, those inserts with only one cutting edge do require offset changes. Refer to the chart here to ensure proper offset adjustments.

insert catalog number	add to C dimension		add to F dimension	
	inch	mm	inch	mm
NGD-3062	.000	0,00	.000	0,00
NGD-3094	.100	2,54	.100	2,54
NGD-3125	.100	2,54	.100	2,54
NGD-3189	.100	2,54	.100	2,54
NGD-4125	.000	0,00	.000	0,00
NGD-4189	.125	3,18	.125	3,18
NGD-4250	.250	6,35	.250	6,35
NRD-3031	.000	0,00	.000	0,00
NRD-3062	.100	2,54	.100	2,54
NRD-4062	.000	0,00	.000	0,00
NRD-4094	.250	6,35	.250	6,35
NRD-4125	.250	6,35	.250	6,35

TopGroove Insert Selection Guide

- All TopGroove inserts are precision ground to provide accurate edge location and secure locking of the insert in the toolholder pocket.
- TopGroove inserts can be used in either toolholders or boring bars.
- Right-hand TopGroove toolholders use right-hand inserts.
Left-hand TopGroove toolholders use left-hand inserts.
- Right-hand TopGroove boring bars use left-hand inserts.
Left-hand TopGroove boring bars use right-hand inserts.

See page D46 for carbide grade selection and more technical information.

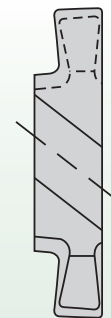

left-hand insert

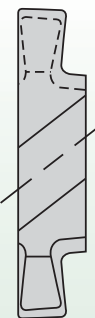

right-hand insert

Machining Guidelines for Poly-Vee Grooving with Custom Solution and TopGroove NV Inserts (NV3-J and NV4-L)

- To machine cross section “J”, use insert NV3-J.
- To machine cross section “L”, use insert NV4-L.

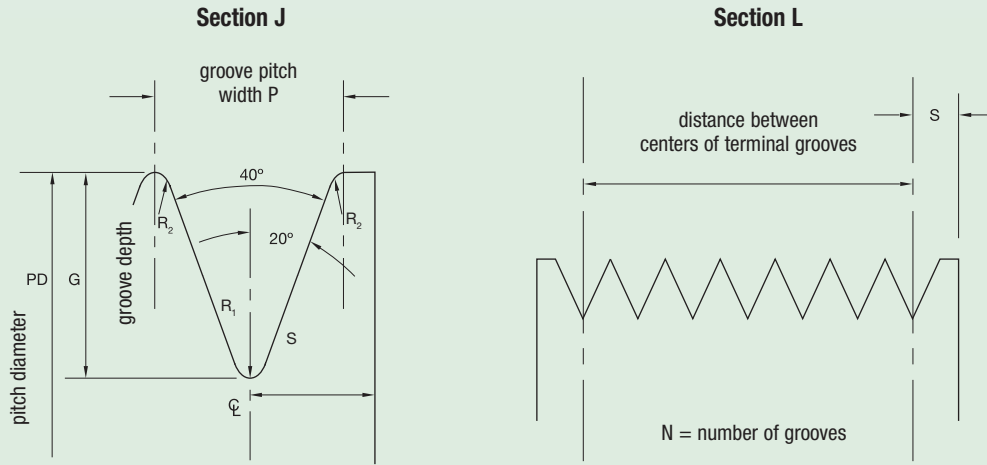

Groove Dimensions and Tolerances for Sheaves

groove cross section	pitch width (P)	groove depth (G)	minimum radius (R2)	radius (R1)	terminal distance	distance between centers of terminal grooves and maximum accumulated tolerance
J	.092 ±.001	.087 ±.005	.008	.0125 ±.0025	1/8	(N-1).092 ±.010
L	.185 ±.002	.201 ±.005	.015	.0125 ±.0025	3/8	(N-1).185 ±.010

Multiple Tooth Poly-Vee Grooving

Let WIDIA™ quote your multiple tooth poly-vee grooving applications. Semi-standard inserts and holders are available. The strong TopGroove design holds the insert rigid and outperforms any other tooling method for this application.

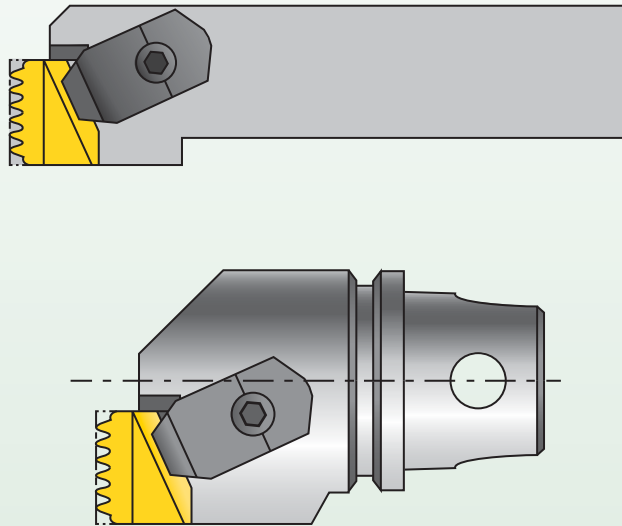

Machining Guidelines for Undercutting Operations Performed with Custom Solution and TopGroove NU Inserts (NU3094, NU3125, and NU3156)

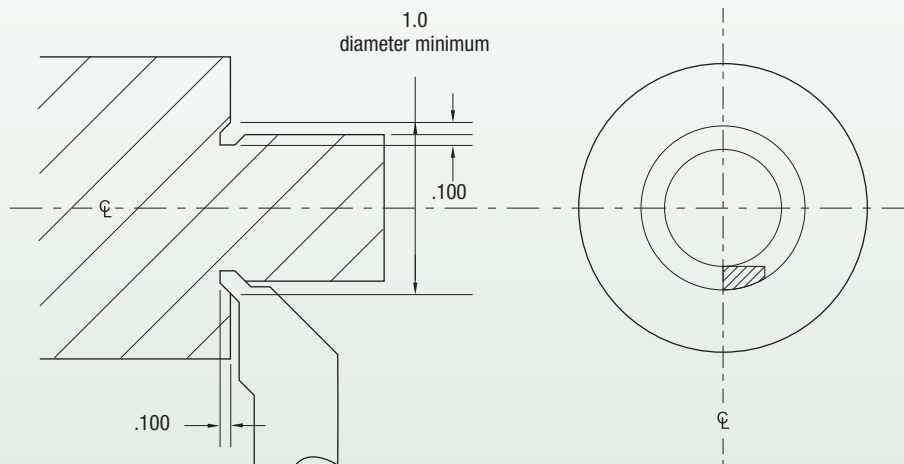

Machining Guidelines for Face Grooving Operations • External

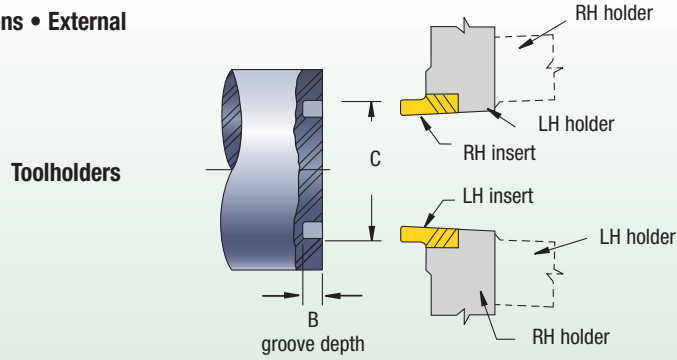

Standard NF/NDF Inserts				
insert family	maximum groove depth B		minimum groove diameter C	
	inch	mm	inch	mm
NF-3	.060	1,52	.94	23,9
NF-3	.094	2,39	1.20	30,5
NF-3	.125	3,18	1.42	36,1
NF-3	.150	3,81	1.63	41,3
NFD-3	.250	6,35	1.88	47,6
NFD-4	.375	9,53	2.25	57,2
NFD-4	.500	12,70	2.25	57,2

Machining Guidelines for Face Grooving Operations • External

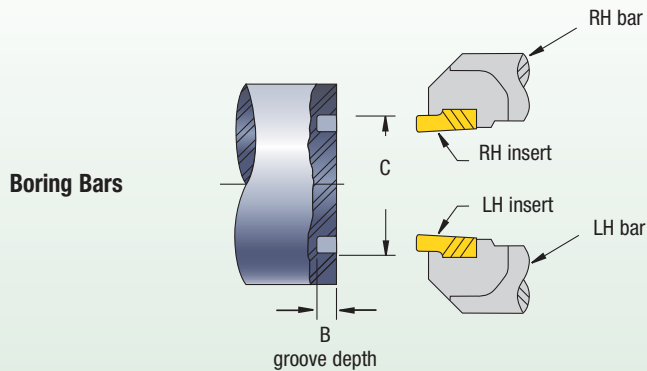

Standard NG/NGD Inserts				
insert family	maximum groove depth B		minimum groove diameter C	
	inch	mm	inch	mm
NG-2	.050	1,27	2.13	54,0
NG-2	.110	2,79	3.50	88,9
NG-3	.094	2,39	4.00	101,6
NG-3	.125	3,18	5.00	127,0
NG-3	.150	3,81	5.50	139,7
NGD-3	.250	6,35	6.88	174,6
NG-4	.150	3,81	6.00	152,4
NG-4	.250	6,35	8.25	209,6
NGD-4	.375	9,53	8.75	222,3
NGD-4	.500	12,70	8.75	222,3

Machining Guidelines for Face Grooving Operations • Internal

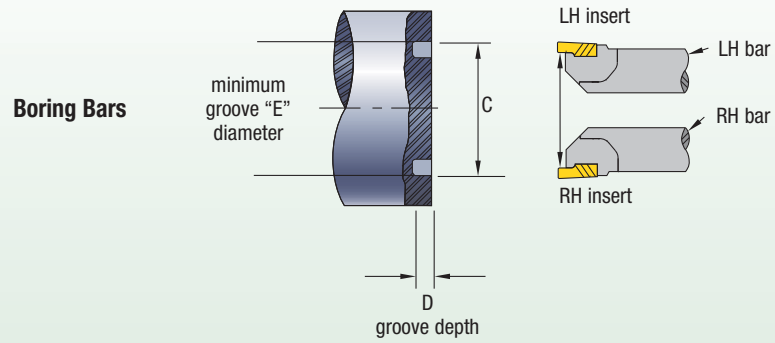

Standard NG/NGD Inserts				
insert family	maximum groove depth D		minimum groove diameter E	
	inch	mm	inch	mm
NFD-3-KI	.250	6,35	2.250	63,5
<p><i>NOTE: Also check minimum bore diameter of boring bar. See page D42.</i></p>				

ProGroove™

ProGroove™ Grooving and Cut-Off

Features and Benefits:

- Single-end grooving and cut-off inserts.
- Offered with integral toolholders and blades.
- Shallow, deep grooving, and cut-off capabilities.
- Available in four different geometries.



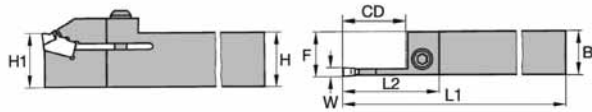

Right Hand Tool

■ Grooving and Cut-Off

order number	catalog number	W	CD	H	B	F	L1	L2	H1	cap screw	wrench
Right hand											
2962743	12250023000	.118	.787	.750	.750	.764	5.000	1.260	.750	12148596200	12148041200
2962745	12250023200	.118	.984	1.000	1.000	1.012	6.000	1.575	1.000	12148596200	12148041200
2962747	12250024000	.158	.984	.750	.750	.768	5.000	1.575	.750	12148596200	12148041200
2962749	12250024200	.158	.984	1.000	1.000	10.160	6.000	1.575	1.000	12148596200	12148041200
2962751	12250025200	.197	1.260	1.000	1.000	1.016	6.000	2.087	1.000	12148596200	12148041200
Left hand											
2962744	12250023100	.118	.787	.750	.750	.764	5.000	1.260	.750	12148596200	12148041200
2962746	12250023300	.118	.984	1.000	1.000	1.012	6.000	1.575	1.000	12148596200	12148041200
2962748	12250024100	.158	.984	.750	.750	.768	5.000	1.575	.750	12148596200	12148041200
2962750	12250024300	.158	.984	1.000	1.000	1.016	6.000	1.575	1.000	12148596200	12148041200
2962752	12250025300	.197	1.260	1.000	1.000	1.016	6.000	2.087	1.000	12148596200	12148041200

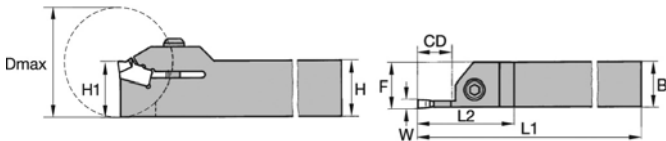

Right Hand Tool

■ Grooving and Profiling

order number	catalog number	W	CD	D max	H	B	F	L1	L2	H1	cap screw	wrench
Right hand												
2962733	12250013000	.118	.394	1.000	.984	.984	.764	5.906	1.221	.750	12148596200	12148041200
2962735	12250013200	.118	.394	1.000	1.000	1.000	1.016	6.000	1.024	1.000	12148596200	12148041200
2962737	12250014000	.158	.492	1.260	.750	.750	.768	5.000	1.221	.750	12148596200	12148041200
2962739	12250014200	.158	.492	1.260	1.000	1.000	1.016	6.000	1.221	1.000	12148596200	12148041200
2962741	12250015200	.197	.492	—	1.000	1.000	1.016	6.000	1.221	1.000	12148596200	12148041200
Left hand												
2962734	12250013100	.118	.394	1.000	.750	.750	.764	5.000	1.024	.750	12148596200	12148041200
2962736	12250013300	.118	.394	1.000	1.000	1.000	1.016	6.000	1.024	1.000	12148596200	12148041200
2962738	12250014100	.158	.492	1.260	.750	.750	.768	5.000	1.221	.750	12148596200	12148041200
2962740	12250014300	.158	.492	1.260	1.000	1.000	1.016	6.000	1.221	1.000	12148596200	12148041200
2962742	12250015300	.197	.492	—	1.000	1.000	1.016	6.000	1.221	1.000	12148596200	12148041200

NOTE: Select shorter CD dimension for added stability.

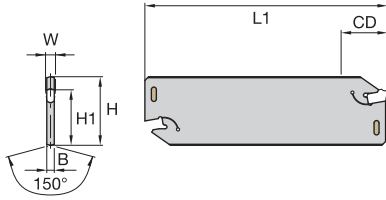

■ **Cut-Off Blades**

order number	catalog number	W	H	H1	L1	B	CD	wrench
2021629	12251332000	.079	.748	.618	3.543	.067	.787	12146003800
2021639	12251342000	.079	1.024	.843	4.331	.067	.984	12146003800
2008113	12251352000	.079	1.260	.984	5.906	.067	.984	12146003800
2021640	12251343000	.118	1.024	.843	4.331	.095	1.575	12146003800
2008116	12251353000	.118	1.260	.984	5.906	.095	1.969	12146003800
2021641	12251344000	.158	1.024	.843	4.331	.126	1.575	12146003800
2008119	12251354000	.158	1.260	.984	5.906	.126	1.969	12146003800
2008122	12251355000	.197	1.260	.984	5.906	.165	2.362	12146003800
2008135	12251356000	.236	1.260	.984	5.906	.197	2.362	12146009500
2008138	12251358000	.315	1.260	.984	5.906	.268	2.362	12146009500
2021743	12251368000	.315	2.067	1.772	9.843	.268	3.937	12146009500

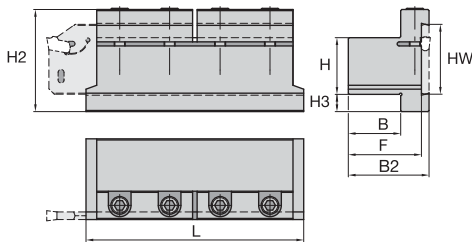

■ **Cut-Off Blade Holders**

order number	catalog number	HW	H	B	F	H2	B2	H3	L	cap screw	wrench
2968845	32251221200	1.024	.750	.750	1.161	1.57	1.34	.32	3.39	125.625	12148041300
2968846	32251221600	1.260	1.000	1.000	1.417	1.89	1.63	.30	4.33	125.630	12148041300
2968847	32251222000	1.260	1.250	1.250	1.673	1.97	1.89	.13	4.33	125.630	12148041300

Grooving, Cut-Off, and Turning • ProGroove

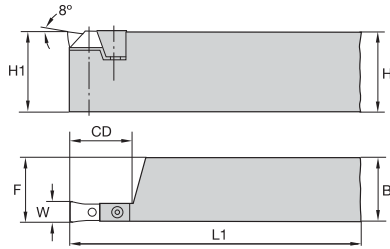

■ Grooving

order number	catalog number	W	CD	H	H1	B	L1	F
Right hand								
2983280	32250110100	.321	.866	1.250	1.250	1.000	6.020	1.021
2983281	32250110300	.400	.906	1.250	1.250	1.000	6.020	1.021
2983282	32250110500	.480	1.181	1.500	1.500	1.250	7.020	1.272
2983973	32250110700	.559	1.181	1.500	1.500	1.250	7.020	1.272
2983974	32250110900	.638	1.339	1.500	1.500	1.250	7.020	1.272
Left hand								
2983975	32250110200	.321	.866	1.250	1.250	1.000	6.020	1.021
2983976	32250110400	.400	.906	1.250	1.250	1.000	6.020	1.021
2983977	32250110600	.480	1.181	1.500	1.500	1.250	7.020	1.272
2983978	32250110800	.559	1.181	1.500	1.500	1.250	7.020	1.272
2983979	32250111000	.638	1.339	1.500	1.500	1.250	7.020	1.272

■ Spare Parts

catalog number	clamping bolt	wedge clamp	clamping screw	wrench for clamp screw	wrench for clamping bolt
Right hand					
32250110100	12148060600	12148094300	12148574100	12148041000	12148046000
32250110300	12148060600	12148094400	12148574700	12148041100	12148046000
32250110500	12148060700	12148094500	12148574900	12148041100	12148040900
32250110700	12148060700	12148094600	12148574000	12148041200	12148040900
32250110900	12148060800	12148094700	12148574000	12148041200	12148041000
Left hand					
32250110200	12148060600	12148094300	12148574100	12148041000	12148046000
32250110400	12148060600	12148094400	12148574700	12148041100	12148046000
32250110600	12148060700	12148094500	12148574900	12148041100	12148040900
32250110800	12148060700	12148094600	12148574000	12148041200	12148040900
32250111000	12148060800	12148094700	12148574000	12148041200	12148041000

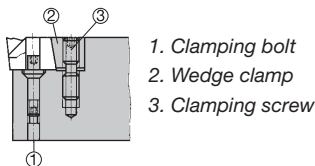

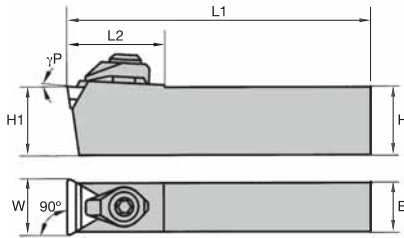

■ Grooving

order number	catalog number	W	H	H1	B	L1	L2	γP°	insert 1
2022921	12191061900	.409	.787	.787	.374	4.921	.827	3	TP..1103../TP..22..
2007414	12191062086	.602	.787	.787	.512	5.906	1.063	3	TP..1603../TP..32..
2022922	12191062586	.602	.984	.984	.512	5.906	1.063	3	TP..1603../TP..32..
2058066	12191062686	.795	.984	.984	.709	5.906	1.378	3	TP..2204../TP..43..
2022923	12191063286	.795	1.260	1.260	.709	7.087	1.378	3	TP..2204../TP..43..

NOTE: Holders 276-STP are supplied without chipbreaker. For chipbreaker order numbers, see below.

■ For Grooving without Chipbreaker

catalog number	clamp	clamp screw	shim	shim screw	washer	wrench
12191061900	12148589300	12148589800	12148032586	12148021900		12148041100
12191062086	12148583800	12148586000	12148031686	12148024100	12148024200	12148041200
12191062686	12148586900	12148021100	12148032086	12148024500	12148024800	12148041200
12191062586	12148583800	12148586000	12148031686	12148024100	12148024200	12148041200
12191063286	12148586900	12148021100	12148032086	12148024500	12148024800	12148041200

■ For Grooving with Chipbreaker (order additional clamp and chipbreaker)

insert	clamp with chipbreaker	D	chipbreakers					
			B — edge width					
			.016	.047	.071	.098	.126	.158
TP...22...	12148589200	.250	12148591011	12148588211	12148588311	12148588411	—	—
TP...32...	12148589300	.375	12148591111	12148586611	12148587011	12148587111	12148580011	—
TP...43...	12148586900	.500	—	—	12148580411	12148580511	12148580611	12148582511

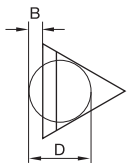

Grooving, Cut-Off, and Turning • 276

WIN WITH WIDIA™

WIDIA™



ProGroove™

With easy-to-change inserts available in multiple high-performance carbide grades, the ProGroove system ensures accurate, reliable, and reproducible cutting edge performance.

ProGroove Grooving and Cut-Off

- Single-end inserts for grooving and cut-off.
- Offered with integral shanks and blades.
- Shallow, deep grooving, and cut-off capabilities.
- Available in four different geometries.

To learn more, contact your local Authorized Distributor or visit www.widia.com.

WIDIA™
Win with WIDIA™

ProGroove System

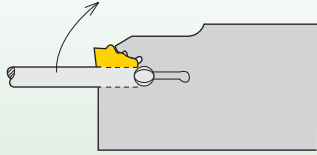

To change the cutting insert, place the wrench into the blade recess. The blade mouth is opened by turning through 90°.

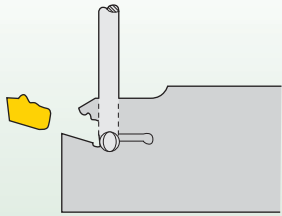

In this position, the wrench is self-locking, leaving both hands free for changing the cutting insert.

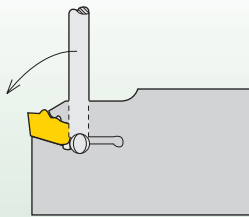

The cutting insert is pressed against the rear seat in the blade mouth, releasing the wrench. The insert is accurately positioned and securely clamped.



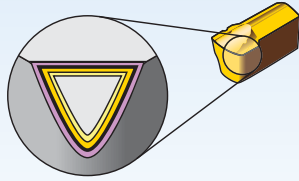





Coatings provide high-speed capability and are engineered for finishing to light roughing.

- Reduce cycle times — high speed and feed capability.
- Longer tool life — new multi-layer coating provides better wear resistance.

P	Steel
M	Stainless Steel
K	Cast Iron
N	Non-Ferrous Materials
S	High-Temp Alloys
H	Hardened Materials

Grade

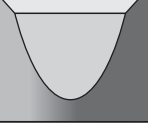
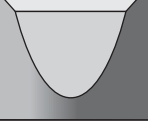
Coating	Grade Description	05	10	15	20	25	30	35	40	45	
TN6030  HC-P30	PVD-TiAlN Nano-layer coated carbide. Medium and heavy machining for steels and nodular cast irons. Recommended at medium cutting speeds when good toughness properties are required.	P									
		M									
		K									
TN7525  HC-P25	MT-CVD/CVD — TiN-TiCN-Al ₂ O ₃ -TiN coated carbide. Light and medium machining for steels and nodular cast irons.	P									
		K									
TN7535  HC-P35	MT-CVD/CVD — TiN-TiCN-Al ₂ O ₃ coated carbide. Medium and heavy machining for steels and nodular cast iron.	P									
		K									
TN8025  HC-M25	MT-CVD/CVD-TiN-TiCN-Al ₂ O ₃ -ZrCN coated carbide. Light and medium machining for all stainless steels. Can be used both with or without coolant.	M									
THM  HW-K15	Uncoated carbide for light and medium machining. For cast iron and all non-ferrous metals and non-metals. Also capable of machining hardened materials at low cutting speeds.	K									
		N									
		S									
		H									
TTM  HW-P25	Uncoated carbide with good toughness and wear properties. Medium machining for steels.	P									
		M									

ProGroove • U

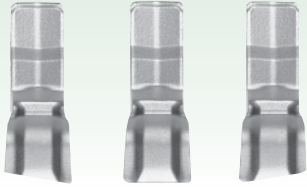

left-hand neutral right-hand

For grooving and parting operations, universal use. Positive chipbreaker groove for light cutting action. Right-hand and left-hand styles with 6° front angle.

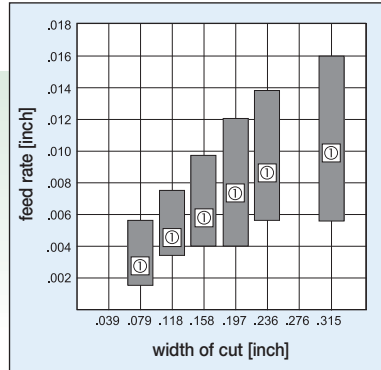

① Recommended feed

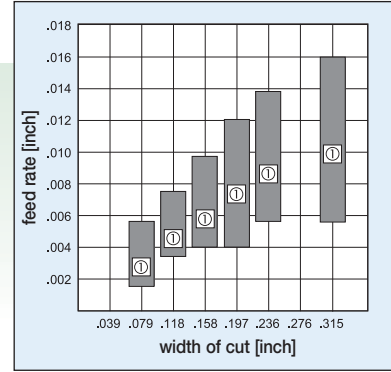

① Recommended feed

ProGroove • M



neutral

For grooving and parting, also capable of copy and straight turning as well as chamfering. With additional chip forming element for good chip control with varying depths of cut.

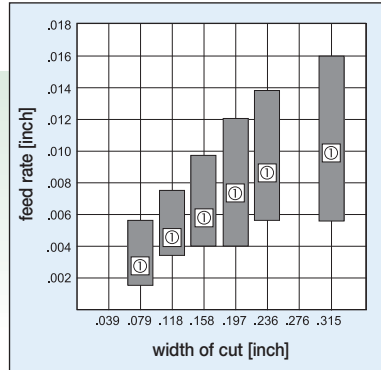

① Recommended feed

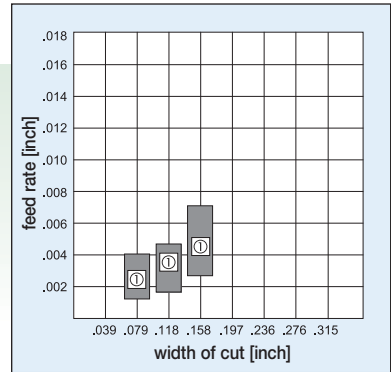

① Recommended feed

ProGroove • S

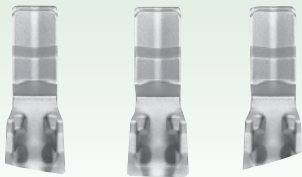

left-hand neutral right-hand

For low-burr parting with straight flanks and smooth surface finishes. All inserts are recommended for parting and grooving slender workpieces, part diameter <1.25", and thin-wall tubes.

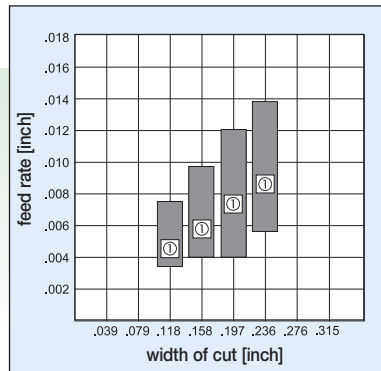

① Recommended feed

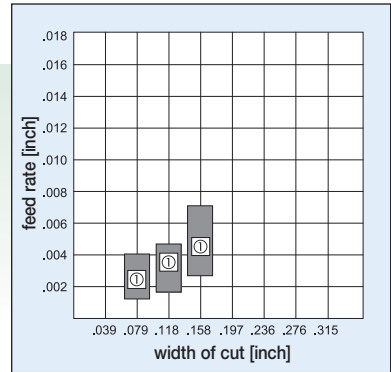

① Recommended feed

ProGroove • R



Full round inserts for profiling, grooving, and copy turning. Very good chip control for broad general use. Accurate, reproducible cutting edge positioning.

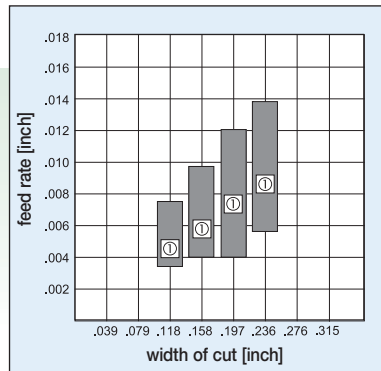

① Recommended feed

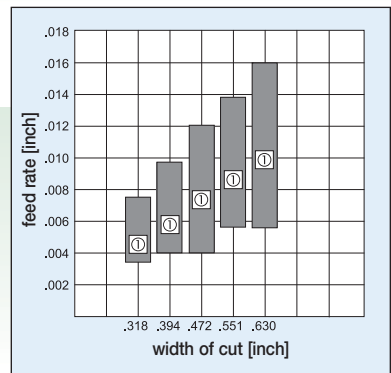

① Recommended feed

LG System • 0 and 1



0 1

...0 Inserts with wide range of applications in grooving and deep grooving. With additional chip control element for good chip control, even with varying widths of cut.

...1 Inserts with wide range of uses in grooving and deep grooving of short chipping materials.

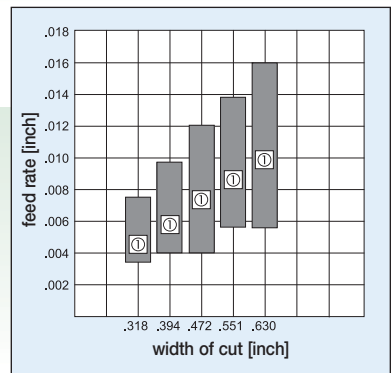

① Recommended feed

ANSI ISO 513	VDI 3323	Cutting Speed • vc SFM																	
Material Group		Cutting Speed • vc SFM																	
		min	Start	max	min	Start	max	min	Start	max	min	Start	max	min	Start	max	min	Start	max
P		TN6030			TN7525			TN7535			TN8025			THM			TTM		
	1	425	455	490	655	705	750	455	570	685							295	310	325
	2	390	520	655	620	800	980	425	520	620							295	340	455
	3	325	425	520	520	670	820	360	455	555							225	295	360
	4	390	490	590	590	750	915	390	490	590							260	340	425
	5	325	425	520	490	635	785	325	425	520							225	295	360
	6	390	490	590	590	750	915	390	490	590							260	340	425
	7	295	410	520	455	620	785	325	425	520							195	275	360
	8	260	360	455	390	555	720	295	390	490							160	245	325
	9	195	260	325	295	410	520	195	295	390							130	160	225
	10	260	310	360	425	490	555	295	340	390							195	225	260
	11	160	210	260	260	340	425	160	210	260							130	160	195
	12	390	455	520	590	685	785	390	505	620							260	310	360
	13.1	260	340	425	425	540	655	295	390	490							195	245	295
13.2	130	180	210	210	275	325	145	195	245							95	130	145	
M		TN6030			TN7525			TN7535			TN8025			THM			TTM		
	14.1	295	390	490							295	390	490				195	245	295
	14.2	245	325	390							245	325	390				160	195	245
	14.3	180	245	310							180	245	310				130	160	180
14.4	145	195	245							145	195	245				95	130	145	
K		TN6030			TN7525			TN7535			TN8025			THM			TTM		
	15	225	295	325	455	555	655							225	295	325			
	16	160	210	260	325	425	520							160	210	260			
	17	195	225	260	390	490	590							195	225	260			
	18	130	180	225	295	390	490							130	180	225			
	19	260	310	360	490	590	685							260	310	360			
20	195	245	295	360	455	555							195	245	295				
N		TN6030			TN7525			TN7535			TN8025			THM			TTM		
	21													1965	2460	2950			
	22													1640	2130	2620			
	23													1965	2460	2950			
	24													1640	2130	2620			
	25													750	980	1210			
	26													490	655	820			
	27													490	655	820			
	28													360	455	555			
	29													195	260	325			
30													260	325	390				
S		TN6030			TN7525			TN7535			TN8025			THM			TTM		
	31													85	120	145			
	32													65	95	115			
	33													55	75	90			
	34													35	45	55			
	35													35	50	55			
	36													135	195	235			
	37													65	95	115			

Grooving, Cut-Off, and Turning • ProGroove

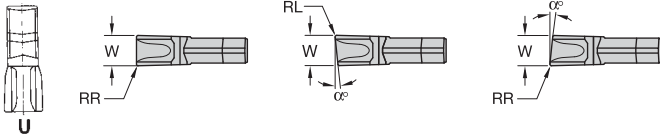

● first choice
○ alternate choice

P	●	●	●	●	●	●	●	●	●
M	●	●	●	●	●	●	●	●	●
K	●	●	●	●	●	●	●	●	●
N	●	●	●	●	●	●	●	●	●
S	●	●	●	●	●	●	●	●	●
H	●	●	●	●	●	●	●	●	●

■ PGU

catalog number	W		RR		α°	hand	TN6030	TN7525	TN7535	TN8025	THM	TTM
	mm	in	mm	in								
123567320	2,10	.083	0,20	.008	—	N - Neutral	●	●	●	●	●	●
123567330	3,10	.122	0,30	.012	—	N - Neutral	●	●	●	●	●	●
123567340	4,10	.161	0,30	.012	—	N - Neutral	●	●	●	●	●	●
123567350	5,10	.201	0,30	.012	—	N - Neutral	●	●	●	●	●	●
123567360	6,10	.240	0,40	.016	—	N - Neutral	●	●	●	●	●	●
123567380	8,15	.321	0,60	.024	—	N - Neutral	●	●	●	●	●	●

catalog number	W		RR		α°	hand	TN6030	TN7525	TN7535	TN8025	THM	TTM
	mm	in	mm	in								
123567231	3,10	.122	0,25	.010	6	L - Left	●	●	●	●	●	●
123567241	4,10	.161	0,25	.010	6	L - Left	●	●	●	●	●	●

catalog number	W		RL		α°	hand	TN6030	TN7525	TN7535	TN8025	THM	TTM
	mm	in	mm	in								
123567230	3,10	.122	0,25	.010	6	R - Right	●	●	●	●	●	●
123567240	4,10	.161	0,25	.010	6	R - Right	●	●	●	●	●	●

NOTE: W tolerance on all = ± 0.002 " ($\pm 0,05$ mm).

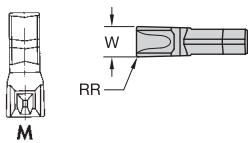

■ PGM

catalog number	W		RR		α°	TN6030	TN7525	TN7535	TN8025	THM	TTM
	mm	in	mm	in							
123567420	2,10	.083	0,20	.008	—	●	●	●	●	●	●
123567430	3,10	.122	0,30	.012	—	●	●	●	●	●	●
123567440	4,10	.161	0,30	.012	—	●	●	●	●	●	●
123567450	5,10	.201	0,30	.012	—	●	●	●	●	●	●
123567460	6,10	.240	0,40	.016	—	●	●	●	●	●	●
123567480	8,15	.321	0,60	.024	—	●	●	●	●	●	●

NOTE: W tolerance on all = ± 0.002 " ($\pm 0,05$ mm).

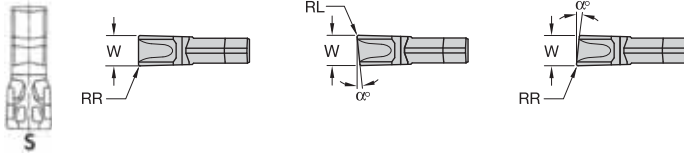

● first choice
○ alternate choice

P	●	●	●	●	●	●	●	●	●
M	●	●	●	●	●	●	●	●	●
K	●	●	●	●	●	●	●	●	●
N	●	●	●	●	●	●	●	●	●
S	●	●	●	●	●	●	●	●	●
H	●	●	●	●	●	●	●	●	●

■ PGS

catalog number	W		RR		α°	hand	TN6030	TN7525	TN7535	TN8025	THM	TTM
	mm	in	mm	in								
123567702	2,25	.089	0,20	.008	—	N - Neutral			●	●		
123567703	3,25	.128	0,20	.008	—	N - Neutral			●	●		
123567704	4,25	.167	0,20	.008	—	N - Neutral			●	●		

catalog number	W		RR		α°	hand	TN6030	TN7525	TN7535	TN8025	THM	TTM
	mm	in	mm	in								
123567721	2,25	.089	0,20	.008	6	L - Left			●	●		
123567731	3,25	.128	0,20	.008	6	L - Left			●	●		
123567741	4,25	.167	0,20	.008	6	L - Left			●	●		

catalog number	W		RL		α°	hand	TN6030	TN7525	TN7535	TN8025	THM	TTM
	mm	in	mm	in								
123567720	2,25	.089	0,20	.008	6	R - Right			●	●		
123567730	3,25	.128	0,20	.008	6	R - Right			●	●		
123567740	4,25	.167	0,20	.008	6	R - Right			●	●		

NOTE: W tolerance on all = ±.002" (±0,05mm).

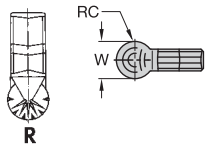

■ PGR

catalog number	W		RC		TN6030	TN7525	TN7535	TN8025	THM	TTM
	mm	in	mm	in						
123567803	3,00	.118	1,50	.059				●		
123567804	4,00	.158	2,00	.079				●		
123567805	5,00	.197	2,50	.098				●		
123567806	6,00	.236	3,00	.118				●		

NOTE: W tolerance on all = ±.003" (±0,07mm).

LG

Grooving Inserts

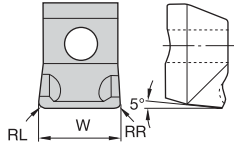

RR = RL

- first choice
- alternate choice

P	●	●	●	●	●	●	●
M	●	●	●	●	●	●	●
K	●	●	●	●	●	●	●
N	●	●	●	●	●	●	●
S	●	●	●	●	●	●	●
H	●	●	●	●	●	●	●

■ LGN0

catalog number	W		RR		TN6030	TN7525	TN7535	TN8025	TFM	TTM
	mm	in	mm	in						
123568080	8,15	.321	0,80	.032	●	●	●	●	●	●
123568100	10,15	.400	0,80	.032	●	●	●	●	●	●
123568120	12,20	.480	0,80	.032	●	●	●	●	●	●
123568140	14,20	.559	0,80	.032	●	●	●	●	●	●
123568160	16,20	.638	0,80	.032	●	●	●	●	●	●

NOTE: W tolerance on all = ±.002" (±0,05mm).

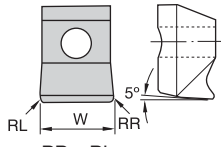

RR = RL

■ LGN1

catalog number	W		RR		TN6030	TN7525	TN7535	TN8025	TFM	TTM
	mm	in	mm	in						
123568081	8,15	.321	0,80	.032					●	
123568101	10,15	.400	0,80	.032					●	
123568121	12,20	.480	0,80	.032					●	
123568141	14,20	.559	0,80	.032					●	
123568161	16,20	.638	0,80	.032					●	

NOTE: W tolerance on all = ±.002" (±0,05mm).

Grooving, Cut-Off, and Turning • LG

On the Web



Fast, Free, and Easy Registration

You can easily register with www.widia.com to obtain full access to the features of the site.

Find a Local Authorized WIDIA™ Distributor in Your Area

The WIDIA Products Group offers world-class products and services globally. Our distributors know us, and more importantly, they know you. They know better than anyone in the industry how to put the global power of WIDIA to work for you — in your industry, in your region, and for your business.

Contact Us

Our customers are important to us. We want to provide you the best customer service in the industry. If you have a comment or question, please send it to us. We strive to respond to all inquiries within 24 hours.

WIDIA Products

Whether your operation is turning, milling, or holmaking, WIDIA brands are the high-performance tooling you need. We offer standard and custom solutions for the general engineering market.

Separator™

Specifically engineered to deliver toolholder flexibility with integral, component, universal, and blade-style designs.

Features:

- Insert widths .063"–.157" (2,0mm–4,0mm).
- Toolholder shank sizes .375"–1.250" (10,0mm–31,75mm).
- Cut-off up 3.0" (76,0mm) bar capacity.

Benefits:

- Quick, reliable insert indexing.
- Positive mechanical clamping.
- CNC square shank, screw machine, and PL blade-style toolholders.



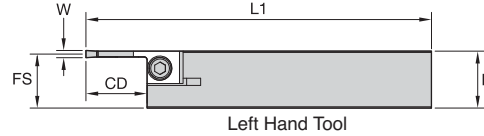
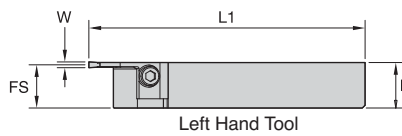
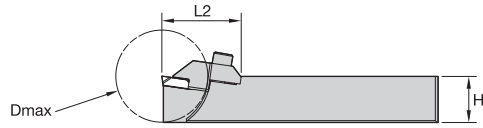

Right Hand Tool

■ Square Shank

order number	catalog number	W	D max	CD	B	FS	H	L2	L1	clamp	clamp screw
Right hand											
3538685	206173	.094	1.063	—	.365	.328	.375	.987	2.630	435152	619122
3538687	206175	.094	1.063	—	.490	.453	.500	.978	6.000	435152	619122
3538679	206167	.094	1.500	—	.615	.578	.625	1.293	4.500	435140	619123
3538683	206171	.094	1.500	—	.740	.703	.750	1.293	4.500	435140	619120
3538672	206145	.125	1.000	—	.488	.437	.500	.928	6.000	435130	619122
3538681	206169	.125	1.500	—	.613	.562	.625	1.293	4.500	435126	619123
3563787	206139	.125	1.500	—	.738	.687	.750	1.293	4.500	435126	619120
3538744	206420	.125	—	1.000	.988	.937	1.000	1.687	6.000	435180	619164
3538745	206421	.188	—	1.000	.978	.906	1.000	1.691	6.000	435180	619164
Left hand											
3538686	206174	.094	1.063	—	.365	.328	.375	.987	2.630	435153	619122
3538688	206176	.094	1.063	—	.490	.453	.500	.978	6.000	435153	619122
3538680	206168	.094	1.500	—	.615	.578	.625	1.293	4.500	435141	619123
3538684	206172	.094	1.500	—	.740	.703	.750	1.293	4.500	435141	619120
3538673	206146	.125	1.000	—	.488	.437	.500	.928	6.000	435131	619122
3538682	206170	.125	1.500	—	.613	.562	.625	1.293	4.500	435127	619123
3563800	206140	.125	1.500	—	.738	.687	.750	1.293	4.500	435127	619120
3538746	206422	.125	—	1.000	.988	.937	1.000	1.687	6.000	435181	619164
3538747	206423	.188	—	1.000	.978	.906	1.000	1.687	6.000	435181	619164

NOTE: Above toolholders are supplied with clamp.

Grooving, Cut-Off, and Turning • Separator

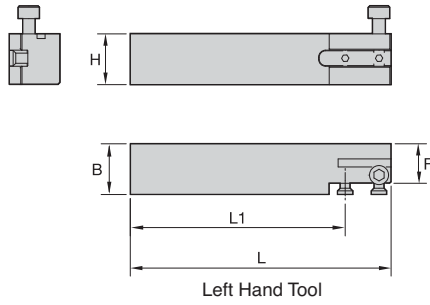

Left Hand Tool

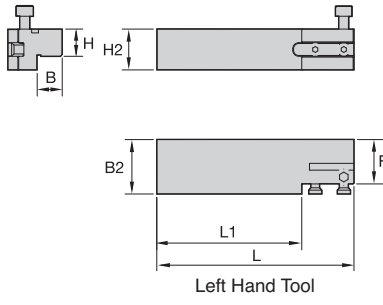

Left Hand Tool



Right Hand Tool

■ 1/2" and 3/4" Shank Toolholders

order number	catalog number	H	B	B2	L	L1	H2	F	hand	support blade screw	clamp screw
3538689	206178	.745	.750	—	3.625	2.913	—	.575	N - Neutral	606167	619124
3563801	206179	.500	.460	1.000	3.625	2.913	.750	.815	R - Right	606167	619124

NOTE: 206178 can use right- or left-hand blade and clamp.

Grooving, Cut-Off, and Turning • Separator • Separator

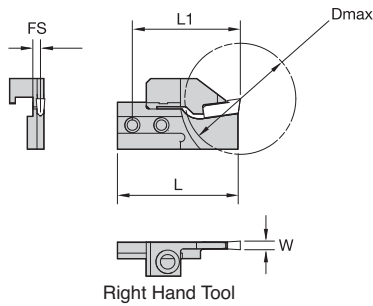

Right Hand Tool

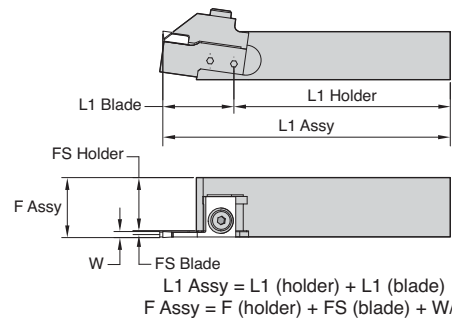

L1 Assy = L1 (holder) + L1 (blade)
F Assy = F (holder) + FS (blade) + W/2

■ 1/2" and 3/4" Shank Blades

order number	catalog number	W	D max	FS	L	L1	clamp
Right hand							
3539515	333101	.094	1.625	.128	1.767	1.580	435154
3539516	333102	.125	1.625	.112	1.767	1.580	435155
Left hand							
3539517	333103	.094	1.625	.128	1.767	1.580	435156
3539518	333104	.125	1.625	.112	1.767	1.580	435157

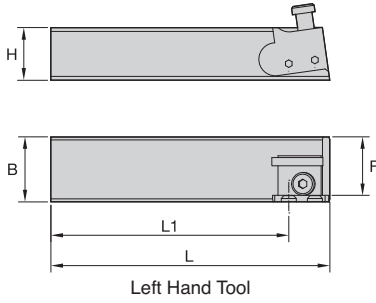

■ 1" and 1-1/4" Shank Toolholders

order number	catalog number	H	B	L	L1	F	support blade screw	clamp screw
Right hand								
3538669	206141	1.000	1.234	5.291	4.510	1.109	606164	619121
3538670	206143	1.250	1.484	5.291	4.510	1.359	606164	619121
Left hand								
3563786	206142	1.000	1.234	5.291	4.510	1.109	606164	619121

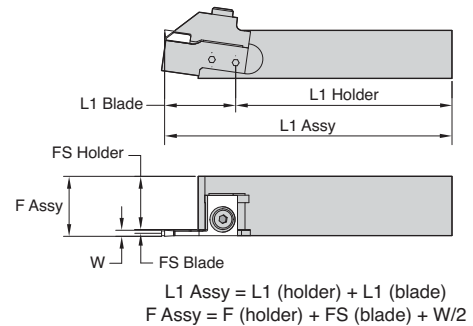
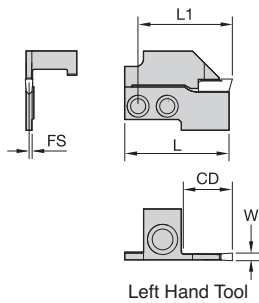

■ 1" and 1-1/4" Shank Blades

order number	catalog number	W	CD	FS	L	L1	clamp
Right hand							
3563591	331117	.094	.500	.094	1.419	1.165	435142
3539504	331101	.125	.813	.078	1.724	1.482	435128
3539506	331103	.188	.813	.078	1.724	1.482	435128
Left hand							
3539510	331118	.094	.500	.094	1.419	1.165	435143
3539505	331102	.125	.813	.078	1.724	1.482	435129
3539507	331104	.188	.813	.078	1.724	1.482	435129

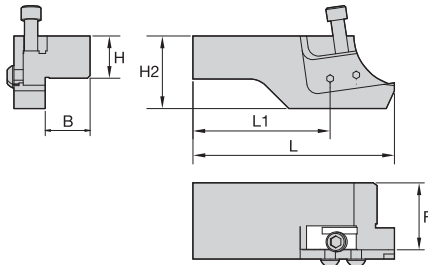

Left Hand Tool



Right Hand Tool

■ Universal Style 2-1/4" Bar Capacity

order number	catalog number	B	H	H2	F	L1	L	support blade screw	clamp screw
Right hand									
3538667	206128	.812	.750	1.719	1.334	2.747	4.270	606171	619112
3538659	206114	.912	1.000	1.719	1.434	3.867	5.390	606171	619112
3538665	206123	1.062	1.000	1.719	1.584	3.247	4.770	606171	S352
3538658	206113	1.062	1.000	1.719	1.584	4.247	5.770	606171	S352
Left hand									
3538662	206118	.812	.750	1.719	1.334	2.747	4.270	606171	619112
3563798	206108	1.062	1.000	1.719	1.434	3.867	5.390	606171	619112
3538668	206136	1.062	1.000	1.719	1.584	3.247	4.770	606171	619112

NOTE: .750" shank holders 206118 and 206128 use different clamps.

■ Components

W	L1	FS	left hand clamp	clamp for toolholder 206118 only	support blade	clamp for toolholder 206128 only	right hand clamp
.094	1.752	.036	435149	435151	310109	435150	435148
.125	1.752	.050	435104	435110	310102	435116	435101
.188	1.752	.072	435105	435109	310108	435117	435102

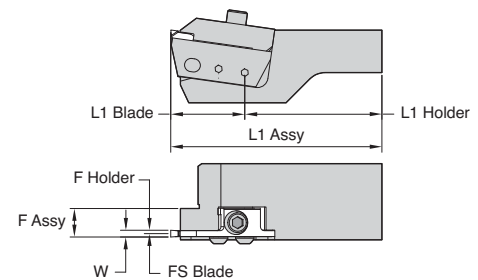

L1 Assy = L1 (holder) + L1 (blade)
 F Assy = F (holder) + FS (blade) + W/2

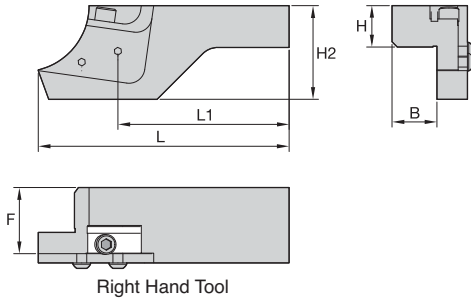

■ Universal Style 3" Bar Capacity

order number	catalog number	B	H	H2	F	L1	L	support blade screw	clamp screw
Right hand									
3538660	206115	.964	1.000	2.219	1.454	3.754	5.640	606171	S352
3538661	206116	1.064	1.000	2.219	1.554	3.754	5.640	606171	619112
3587587	206121	1.194	1.250	2.219	1.684	4.004	5.890	606171	619112
Left hand									
3563799	206110	1.074	1.000	2.219	1.554	3.304	5.190	606171	619112
3538663	206119	1.104	1.000	2.219	1.554	3.754	5.640	606171	619112

■ Components

W	L1	FS	left hand clamp	support blade	right hand clamp
.125	2.246	.050	435137	309111	435136
.188	2.246	.072	435106	309105	435103
.250	2.246	.094	435107	309106	435108

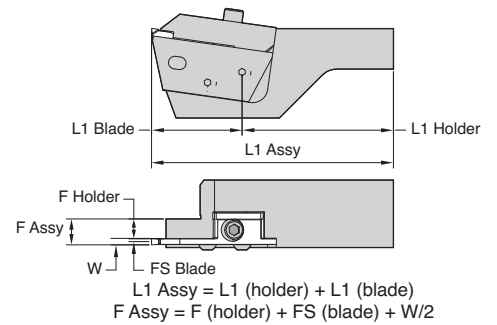

Grooving, Cut-Off, and Turning • Separator

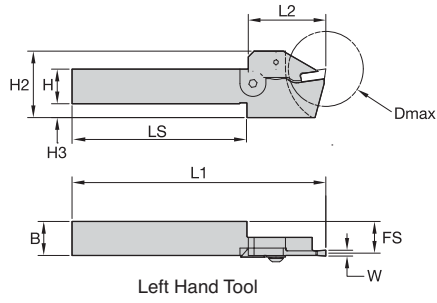

■ Sub-Spindle

order number	catalog number	W	D max	B	FS	H	H2	H3	L1	LS	L2	button-head cap screw	clamp	flat-head cap screw	washer
Right hand															
3538762	206502	.094	1.630	.740	.703	.750	1.444	.300	5.500	3.790	1.680	619174	409184	619177	613139
3538760	206500	.126	2.630	.987	.937	1.000	1.754	.375	6.000	3.600	2.375	619174	409182	619175	613139
3538761	206501	.126	2.630	.987	.937	1.000	1.754	.375	6.000	3.600	2.375	619174	409183	619175	613139
Left hand															
3538765	206505	.126	1.630	.737	.687	.750	1.439	.300	5.500	3.790	1.681	619174	409187	619176	613139
3538764	206504	.126	1.630	.737	.687	.750	1.439	.300	5.500	3.790	1.681	619174	409186	619176	613139

Grooving, Cut-Off, and Turning • Separator • Separator

WIN WITH WIDIA™

WIDIA 



Separator™

Specifically engineered to deliver toolholder flexibility with integral, component, universal, and blade-style designs.

Separator Toolholders and Inserts

- Insert widths .079"–.157" (2,0mm–4,0mm).
- Toolholder shank sizes .394"–1.25" (10,0mm–31,75mm).
- Cut-off up to 2.99" (76,0mm) bar capacity.
- Quick, reliable insert indexing.
- Positive mechanical clamping.
- CNC square shank, screw machine, and PL blade-style toolholders.

To learn more, contact your local Authorized Distributor or visit www.widia.com.

WIDIA 
Win with WIDIA™

1 Choose the application to be performed:
Choose lead angle of insert for application.

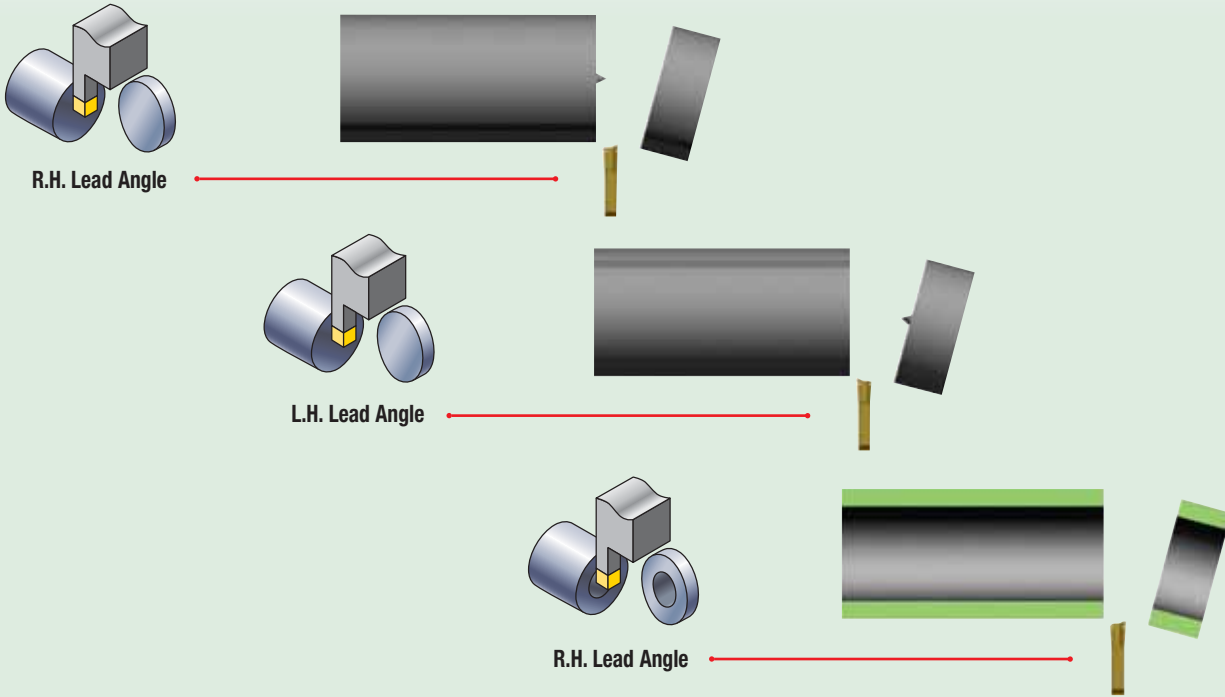

2 Identify the material to be machined:
Each tool has a material grid marked with a letter indicating the materials that can be machined.

P	Steel
M	Stainless Steel
K	Cast Iron
N	Non-Ferrous Materials
S	High-Temp Alloys
H	Hardened Materials

3 Select your toolholder based on the application:

- A Choose the appropriate width of insert required for the application.
- B Choose the shortest cutting depth "CD" dimension for increased tool rigidity.
- C Select the largest toolholder shank "H" and "B" dimensions for maximum rigidity.

Separator™ Toolholders **WIDIA MANCHESTER**

■ Square Shank

order number	catalog number	A		B		C		FS	H	L2	L1	clamp	clamp screw
		W	D max	CD	B	H							
	Right hand												
3530685	206173	.094	1.063	—	.365	.328	.375	.987	2.630			435152	619122
3530667	206175	.094	1.063	—	.490	.453	.500	.976	6.000			435152	619122
3530679	206167	.094	1.500	—	.815	.578	.625	1.293	4.500			435140	619123
3530663	206171	.094	1.500	—	.740	.703	.750	1.293	4.500			435140	619120
3530672	206145	.125	1.000	—	.448	.437	.500	.908	6.000			435130	619122
3530681	206166	.125	1.500	—	.815	.562	.625	1.293	4.500			435126	619123
3563787	206139	.125	1.500	—	.738	.687	.750	1.293	4.500			435126	619120
3530744	206430	.125	—	1.000	.958	.937	1.000	1.687	6.000			435180	619164
3530745	206421	.188	—	1.000	.978	.906	1.000	1.691	6.000			435180	619164
	Left hand												
3530666	206174	.094	1.063	—	.365	.328	.375	.987	2.630			435153	619122
3530666	206176	.094	1.063	—	.490	.453	.500	.976	6.000			435153	619122

4 Select chipbreaker style for the application:

See the application guide on page D97 for a complete list of insert styles.

insert type	steel	stainless steel	cast iron	non-ferrous metals	high-temp alloys	hardened materials
first choice	X²-Ultra (X ² has wipers)	X²-Ultra	X²-Ultra	X²-Ultra	X²-Ultra	—
second choice	S²-Ultra	S²-Ultra	Classic	S²-Ultra	S²-Ultra	—

5 Select grade:

machining condition	Recommended Grades				
	steel	stainless steel	cast iron	non-ferrous metals	high-temp alloys
high performance for optimal conditions (clean cuts, good machine condition, higher speed capability)	M-93	M433B	M-93	M-93	M-433B
	—	M-93	—	—	M-93
general purpose (1st choice for general machining)	M-43	M-43	M-43	M-43	M-43
unfavorable conditions (interrupted cuts, low speeds, etc.)	M-45	M-45	M-45	M-45	M-45
	M-40	M-40	M-40	M-40	M-40

See page D96 for Grades and Grade Descriptions.

6 Determine cutting data:

- A Based on material group and grade, identify starting speed (vc).
- B First choice starting speed is in **bold**.

See page D98 for cutting data.

ANSI ISO 513		VDI 3323		Cutting Speed • vc SFM																							
Material Group				min		Start		max		min		Start		max		min		Start		max							
P	1	1	1	C2						CS						GC						M40					
				300		400		500		570		645		720		125		260		370							
				240		350		460		490		560		630		110		220		330							
				210		275		340		418		485		520		90		165		240							
				220		305		390		460		500		540		100		185		290							
				190		270		350		370		420		470		80		155		230							
				225		308		390		460		500		540		100		195		290							
				190		270		350		390		440		490		85		160		235							
				180		260		340		340		395		450		75		150		220							
				125		198		270		230		295		360		60		120		180							
				150		250		310		360		395		430		80		155		230							
				105		188		270		205		305		405		60		115		170							
				235		313		390		450		510		570		120		225		330							
220		290		300		348		390		440		95		155		215											
100		140		180		170		200		230		55		90		125											
M	14.1	14.1	14.1	C2						CS						GC						M40					
				180		190		220		100		145		190													
				150		178		205		85		130		170													
				125		140		155		70		95		120													
K	15	15	15	C2						CS						GC						M40					
				450		550		650		250		350		450													
375		440		500		170		265		360																	
425		500		570		200		310		420																	
300		375		450		130		240		330																	

Separator • X² and X²-Ultra



X²

This insert has the same geometry as the WMT-SX™. Chip control geometry offers the widest range of speed and feed capabilities and provides excellent flatness and finish. This chipbreaker cuts with the least amount of tool pressure, extending tool life. The geometry also includes wipers and a corner radius. This geometry works well on a variety of materials.



X²-Ultra

This insert has the same geometry as the WMT-SX-Ultra. The X²-Ultra is an enhanced version of the X² and is ideal for stainless steels, nickel-based alloys, tool steel, INCONEL®, and titanium.

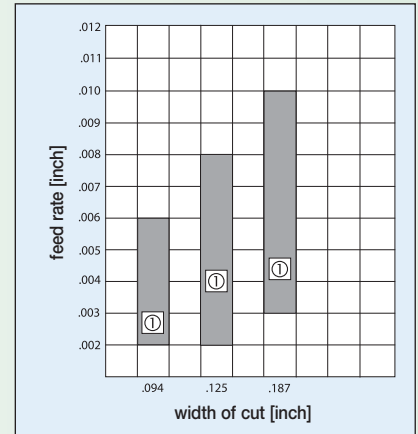

① Recommended feed

Separator • S² and S²-Ultra



S²

High positive rake with a more open chipbreaker enables increased speeds and feeds for moderate- to high-speed applications. The geometry includes wipers and a corner radius that provides superior flatness and finish. This insert is also available with sharp corners. Its greatest strengths can be seen on stainless steels and soft gummy steels.



S²-Ultra

The S²-Ultra is an enhanced version of the S² and is ideal for 300 series stainless steels, nickel-based alloys, tool steel, INCONEL, and titanium at moderate to high speeds and feeds.

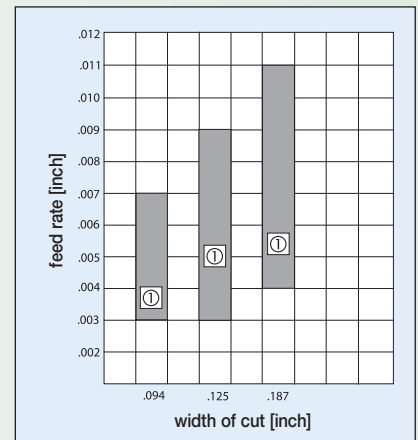

① Recommended feed

Separator • Classic and F²



Classic

A good general-purpose insert for carbon steels, alloy steels, and most stainless steels. The Separator Classic chipbreaker is designed to perform well at moderate to slow speeds and feeds. The Classic provides standard high lead angles and sharp corners, making it the first choice when choosing an insert for nib-free cut-off.

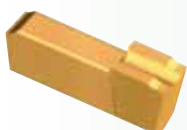

F²

This insert provides superior flatness and finish on a wide variety of materials. Ideal for thick wall parts or cutting off larger diameter parts to center. The Separator F² performs well at slow to moderate speeds and feeds.

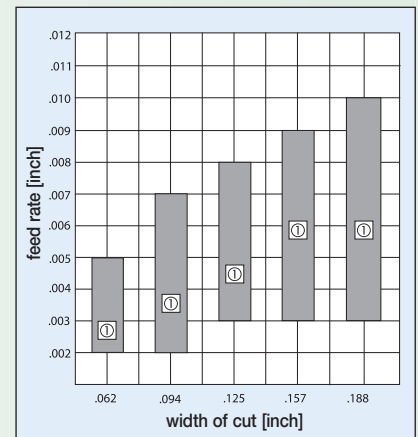

① Recommended feed

Grooving, Cut-Off, and Turning • Separator

ANSI ISO 513	VDI 3323	Cutting Speed • vc SFM											
Material Group		C2			C5			GC			M40		
		min	Start	max	min	Start	max	min	Start	max	min	Start	max
P	1				300	400	500	570	645	720	125	260	370
	2				240	350	460	490	560	630	110	220	330
	3				210	275	340	410	465	520	90	165	240
	4				220	305	390	460	500	540	100	195	290
	5				190	270	350	370	420	470	80	155	230
	6				225	308	390	460	500	540	100	195	290
	7				190	270	350	390	440	490	85	160	235
	8				180	260	340	340	395	450	75	150	220
	9				125	198	270	230	295	360	60	120	180
	10				190	250	310	360	395	430	80	155	230
	11				105	188	270	205	305	405	60	115	170
	12				235	313	390	450	510	570	120	225	330
	13.1				220	260	300	340	390	440	95	155	215
13.2				100	140	180	170	200	230	55	90	125	
M	14.1	160	190	220							100	145	190
	14.2	150	178	205							85	130	170
	14.3	125	140	155							70	95	120
	14.4	90	105	120							50	75	100
K	15	450	550	650							250	350	450
	16	375	440	500							170	265	360
	17	425	500	570							200	310	420
	18	300	375	450							150	240	330
	19	500	600	700							275	375	475
20	400	475	550							180	290	400	
N	21	1000	1350	1700							700	1200	1700
	22	800	1150	1500							500	1000	1500
	23	1000	1350	1700							700	1200	1700
	24	800	1150	1500							500	1000	1500
	25	700	800	900							450	675	900
	26	500	550	600							300	450	600
	27	500	550	600							300	450	600
	28	300	350	400							200	300	400
	29	200	250	300							150	225	300
	30	250	300	350							150	250	350
S	31	120	145	170							90	125	160
	32	90	100	110							70	85	100
	33	70	75	80							45	60	75
	34	60	65	70							40	50	60
	35	60	65	70							40	50	60
	36	180	195	210							110	155	200
	37	90	100	110							60	80	100

Cutting Speed • vc SFM												VDI 3323	ANSI ISO 513
min	Start	max	min	Start	max	min	Start	max	min	Start	max	Material Group	
M43			M433B			M45			M93			1 2 3 4 5 6 7 8 9 10 11 12 13.1 13.2	P
350	525	700	—	—	—	150	275	400	500	650	800		
280	455	630	—	—	—	140	250	360	425	550	700		
240	365	490	—	—	—	115	190	265	360	475	570		
260	405	550	—	—	—	130	225	320	400	490	600		
210	340	470	—	—	—	100	175	250	325	425	520		
260	405	550	—	—	—	130	225	320	400	500	600		
215	345	475	—	—	—	110	175	245	340	440	540		
200	330	455	—	—	—	90	160	230	300	400	500		
140	255	370	—	—	—	70	135	200	200	300	400		
210	305	400	—	—	—	100	170	240	320	400	475		
115	245	375	100	235	370	70	130	190	180	320	450		
280	395	510	280	405	530	130	245	360	390	505	620		
260	330	400	260	340	420	110	180	250	295	390	490		
110	160	210	110	170	230	65	100	140	150	200	250		
M43			M433B			M45			M93			14.1 14.2 14.3 14.4	M
170	250	330	180	300	420	110	165	220	295	390	490		
140	205	270	150	245	340	105	155	205	245	325	390		
110	160	210	120	195	270	85	120	155	180	245	310		
85	125	165	90	150	210	60	90	120	145	195	245		
M43			M433B			M45			M93			15 16 17 18 19 20	K
350	500	650	750	950	1150	300	400	500	500	650	800		
250	375	500	550	750	950	200	325	450	350	500	650		
300	435	570	650	850	1050	230	360	490	400	550	700		
200	325	450	600	800	1000	175	275	375	375	525	675		
400	550	700	800	1000	1200	320	420	520	550	590	850		
270	410	550	700	900	1100	210	340	470	360	460	700		
M43			M433B			M45			M93			21 22 23 24 25 26 27 28 29 30	N
900	1450	2000				800	1300	1800	1000	1600	2200		
700	1250	1800				600	1100	1600	800	1400	2000		
900	1450	2000				800	1300	1800	1000	1600	2200		
700	1250	1800				600	1100	1600	800	1400	2000		
600	850	1100				500	750	1000	700	1000	1300		
400	550	700				350	500	650	500	650	800		
400	550	700				350	500	650	500	650	800		
250	350	450				225	325	425	300	450	600		
180	265	350				150	240	325	200	300	400		
200	300	400				175	275	375	250	400	500		
M43			M433B			M45			M93			31 32 33 34 35 36 37	S
100	140	180	110	155	200	100	135	170	120	170	220		
75	95	120	80	105	130	75	90	110	95	115	150		
50	70	90	60	80	100	50	65	80	75	90	115		
45	55	70	50	65	80	45	55	70	60	75	90		
45	55	70	50	65	80	45	55	70	60	75	90		
120	170	220	130	180	230	120	165	210	180	220	260		
75	95	115	80	105	130	75	90	110	95	115	145		

Grooving, Cut-Off, and Turning • Separator

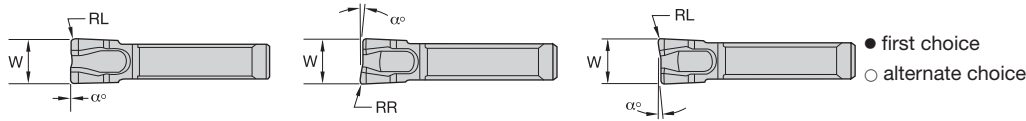

P	■	○	○	●	●	●	●	●	●
M	■	○	○	●	●	●	●	●	●
K	■	○	○	○	○	○	○	○	○
N	■	○	○	○	○	○	○	○	○
S	■	○	○	○	○	○	○	○	○
H	■	○	○	○	○	○	○	○	○

■ X²

catalog number	W		RR		α°	hand	C2	C5	GC	M40	M43	M43B	M45	M83
	mm	in	mm	in										
507305	2,39	.094	0,14	.006	—	N - Neutral					●	●	●	●
507308	3,20	.126	0,17	.007	—	N - Neutral					●	●	●	●

catalog number	W		RR		α°	hand	C2	C5	GC	M40	M43	M43B	M45	M83
	mm	in	mm	in										
507307	2,39	.094	0,14	.006	5	L - Left					●	●	●	●
507310	3,20	.126	0,17	.007	5	L - Left					●	●	●	●

catalog number	W		RL		α°	hand	C2	C5	GC	M40	M43	M43B	M45	M83
	mm	in	mm	in										
507306	2,39	.094	0,14	.006	5	R - Right					●	●	●	●
507309	3,20	.126	0,17	.007	5	R - Right					●	●	●	●

■ X² Ultra

catalog number	W		RR		α°	hand	C2	C5	GC	M40	M43	M43B	M45	M83
	mm	in	mm	in										
507354	2,39	.094	0,15	.006	—	N - Neutral					●	●	●	●
507357	3,20	.126	0,15	.006	—	N - Neutral					●	●	●	●

catalog number	W		RR		α°	hand	C2	C5	GC	M40	M43	M43B	M45	M83
	mm	in	mm	in										
507356	2,39	.094	0,13	.005	5	L - Left					●	●	●	●
507359	3,20	.126	0,15	.006	5	L - Left					●	●	●	●

catalog number	W		RL		α°	hand	C2	C5	GC	M40	M43	M43B	M45	M83
	mm	in	mm	in										
507355	2,39	.094	0,13	.005	5	R - Right					●	●	●	●
507358	3,20	.126	0,15	.006	5	R - Right					●	●	●	●

Grooving, Cut-Off, and Turning • Separator • Separator

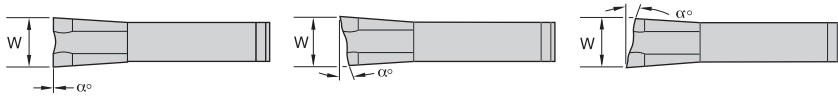

● first choice
○ alternate choice

P	●	○	○	○	○	○	○	○	○
M	○	○	○	○	○	○	○	○	○
K	○	○	○	○	○	○	○	○	○
N	○	○	○	○	○	○	○	○	○
S	○	○	○	○	○	○	○	○	○
H	○	○	○	○	○	○	○	○	○

■ F2

catalog number	W			hand	C2	C5	GC	M40	M43	M43B	M45	M93
	mm	in	α°									
507240	2,39	.094	—	N - Neutral				●			●	
507244	3,20	.126	—	N - Neutral				●			●	
catalog number	W			hand	C2	C5	GC	M40	M43	M43B	M45	M93
	mm	in	α°									
507255	2,39	.094	12	L - Left				●				
507257	3,18	.125	4	L - Left							●	
507258	3,18	.125	12	L - Left							●	
507259	3,18	.125	18	L - Left							●	
catalog number	W			hand	C2	C5	GC	M40	M43	M43B	M45	M93
	mm	in	α°									
507241	2,39	.094	4	R - Right				●			●	
507242	2,39	.094	12	R - Right				●			●	
507243	2,39	.094	18	R - Right				●			●	
507245	3,18	.125	4	R - Right				●			●	
507246	3,18	.125	12	R - Right				●			●	
507247	3,18	.125	18	R - Right				●			●	
507252	4,75	.187	4	R - Right				●			●	
507253	4,78	.188	12	R - Right				●	●		●	

Grooving, Cut-Off, and Turning • Separator

Definitions and Guidelines

1. Width of cut (W) = width of the insert.
2. Lead angle = 0° (neutral); 4°, 5°, 12°, 18° (RH or LH).

Reduce burr of cut-off faces:

- Use lead angle-type inserts (Figures 1 and 2). Lead angle on a cut-off insert reduces the burr that remains on the part but decreases tool life and increases tool side deflection and possibly cycle time.

Figure 1
Insert selection **left-hand lead**

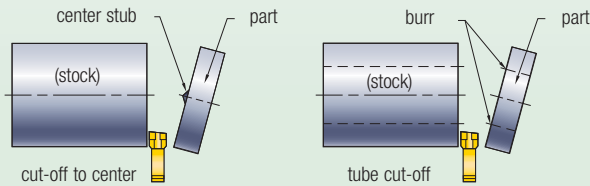

Left-hand lead insert leaves center stub or burr on part and produces clean stock surface.

Figure 2
Insert selection **right-hand lead**

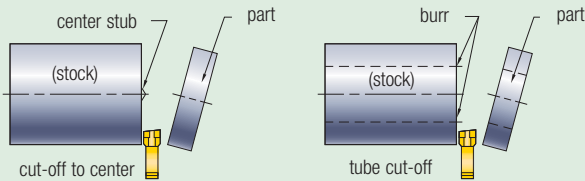

Right-hand lead insert leaves center stub or burr on stock and produces clean part surface.

- Check total height and maintain on center with part diameter.
- The cutting edge height should be within $\pm .004"$ (0,1mm) to the center; recommended cutting position is $.002"$ (0,05mm) above center.

Figure 3
Above center

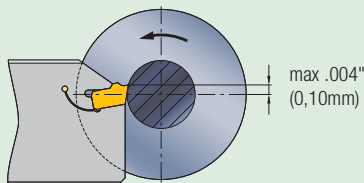

- If 0° lead angle is mandatory, use the narrowest possible cut-off insert and blade. This will minimize the center stub or cut-off burr length. Decrease the feed rate to maximum $.002"$ (0,05mm) or less at the point where diameter equals insert width.

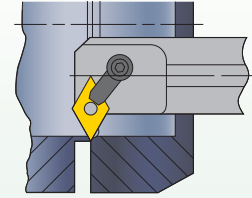

Figure 4
Internal chamfer line up

- On tubing-type parts that require a chamfer on the ID, align ID chamfer tool with cut-off surface. This will enable the chamfering operation to actually separate the part from the bar (see Figure 4). Note the part may drop onto the chamfering bar, which, in this case, will act like a catcher for the part.

Improve surface finish of cut-off faces:

- Use insert with 0° lead angle.
- Increase coolant flow or improve application technique, as shown in Figure 5.
- Decrease the feed rate near the break-through point of the cut.
- Check that the grooving tool is set at the correct angle.
- Use blades with the greatest possible face height and smallest possible cutting width.
- Increase the speed.

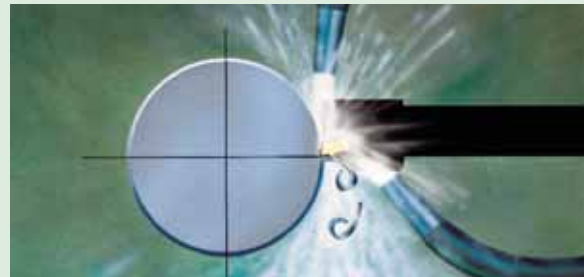

Figure 5
Preferred method for applying coolant

- Mount cut-off tool upside down. This enables gravity to remove chips and avoid cutting the chips twice. Another benefit of mounting the tool upside down is preventing chips from wedging between the tool insert and the groove side walls, which galls the side wall surfaces.

Improve chip control:

- Adjust feed rate up or down to accommodate chip formation.
- Use a 0° or smallest lead available.
- Use ample amounts of well-directed coolant (see Figure A).
- Maintain sharp cutting edge and corners.

Improve flatness of cut-off surfaces:

- Maintain 90° position (perpendicular alignment) between cut-off tool and workpiece.
- For low to moderate speed (sfpm), use Separator F2.
- For moderate to high speed (sfpm), use Separator S² or X².
- Use strongest toolholder system possible.
- Use 0° lead angle inserts when possible. If lead angle inserts are needed, reduce the feed rate.
- Check for minimum overhang of holder and blade.
- Set up for minimum workpiece overhang (distance out of chuck).
- Reduce feed rate.
- Maintain sharp edge and corners on cut-off insert.
- Increase speed (RPM).
- Use ample amounts of well-directed coolant (see Figure A).
- Maintain proper tool center height .000"–.005" (0,0mm–0,0001mm) above center (see Figure B).

Improve surface finish:

- For low to moderate speed (sfpm), use Separator F2.
- For moderate to high speed (sfpm), use Separator S² or X².
- Avoid overly aggressive chip control.
- Increase speed.
- Reduce lead angle and feed rate.
- Determine if corner radius is too large or small.
- Use a coated grade.
- Use coolant (see Figure A).

Figure A

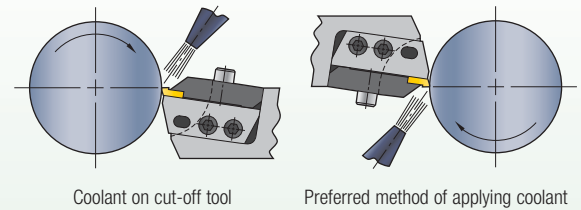
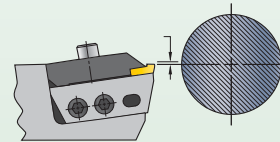

Figure B



Minimize edge chipping:

- Check to see if tool is significantly above or below center.
- Reduce feed prior to part drop off.
- Use Separator S² or X².
- Choose the proper speed associated with the insert grade used.
- Call Technical Support to see if a larger hone size is needed.
- Eliminate chatter.
- Avoid chip re-cutting.
- Check for these part and machine problems:
 - Slide is loose.
 - Slide travel is irregular.
 - Bar/tube ID and/or OD is out of round.
 - Bar/tube is bent.
 - Thin wall collapses (deforms) in the cut.
 - Part is unstable.
 - Cut-off through unturned stock.
 - Excessive tool overhang.
 - Bent or partly attached flash ring.

(continued)

(continued)

Eliminate chatter:

- Minimize tool blade and holder overhang.
- Minimize part overhang.
- Use strongest toolholder system.
- Use a more narrow width of insert.
- Chipbreaker might be too aggressive. (Call Technical Support.)
- Adjust speed and feed rate up or down.
- Hold workpiece rigidly.
- With a longer part, support with steady rest or live center.
- Avoid machine dwell.
- Use S² or X² to reduce cutting forces.

Reduce cut-off nib on solid bar or ID burr on tubing:

- Check tool height. Insert cutting edge should be on center to .002" (0,05mm) above centerline of workpiece.
- To reduce nib on part, use a high lead angle-type insert. Lead angle on a cut-off insert reduces the nib, which remains on the workpiece. CAUTION: the higher the lead, the more tool-side deflection.
- Use the narrowest possible cut-off insert to minimize the cut-off burr length.
- Reduce feed rate at the end of a cut.
- On most tubing-type parts, a 4° or 5° lead angle will be sufficient.
- Add support to a long slender-type part.
- Maintain proper sub-spindle alignment.
- If nib or burr persists, call Technical Support about reducing hone size.
- Use small- or no-corner radius.

Eliminate built-up edge:

- Select proper grade for insert.
- Increase speed (RPM).
- Increase the feed rate.
- Use ample amounts of well-directed coolant (see Figure A on page D105).

Chamfer and cut-off operations:

- Use Separator S² or X².
- Groove or breakdown workpiece surface being machined.
- Machine the chamfer.
- For jobs requiring a chamfer on both ends of the part, begin by plunging to a depth just beyond the depth of the chamfers. Then, return to the part OD and profile each chamfer individually. Finish the cut-off after completion of the second chamfer.
- Cut off the workpiece (see Figure C).

Figure C

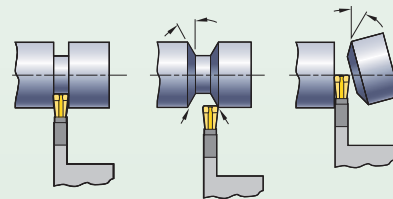

Modifications for Increased Depth of Cut

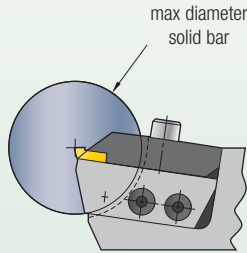

Figure 1
Standard bar capacity shown

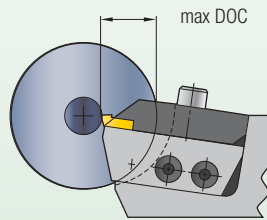

Figure 2
Larger bar diameter shown

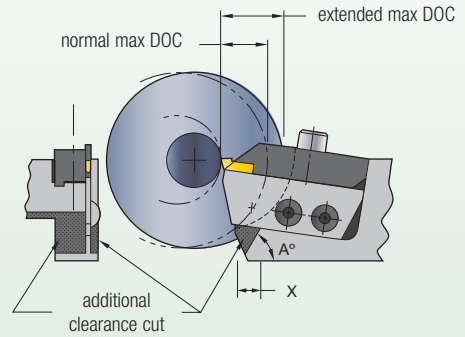

Figure 3
Modified toolholder with larger bar diameter shown

Capacity Chart for 2-1/4" Diameter Bar Capacity Tooling

bar diameter	2.5"	3.0"	3.5"	4.0"	4.5"	5.0"	6.0"	NOTE
max DOC	0.94"	0.75"	0.62"	0.56"	0.50"	0.47"	0.44"	with no modification on toolholder
	1.12"	1.03"	0.97"	0.91"	0.87"	0.84"	0.78"	with no modification on toolholder X = .40" A = 50"

Capacity Chart for 3" Diameter Bar Capacity Tooling

bar diameter	3.5"	4.0"	4.5"	5.0"	6.0"	NOTE
max DOC	1.12"	1.00"	0.88"	0.78"	0.69"	with no modification on toolholder
	1.44"	1.37"	1.31"	1.25"	1.12"	with no modification on toolholder X = .40" A = 50"

Ranger™

Ranger™ Adjustable Face Grooving System

Features:

- Enables the adjustment of the support blade from 2.25" (57,0mm) to 16" (406,0mm) diameter for initial plunge.
- Insert widths .126" (3,2mm); .188" (4,9mm); and .250" (6,4mm).

Benefits:

- Available in both CW and CCW rotation and in both sweep-in or sweep-out styles.
- 2.25" (57,0mm) to 16" (406,0mm) OD face grooving with one adjustable assembly.



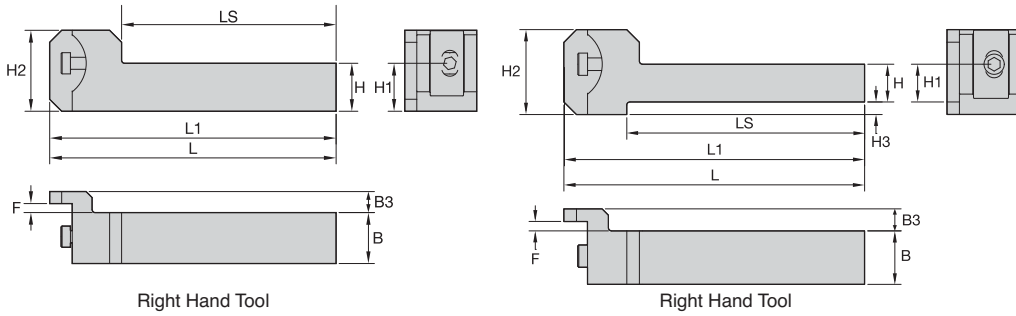

Left Hand Assembly

■ Square Shank

order number	catalog number	B	B3	F	H	H1	H2	H3	L	L1	LS	support blade screw	nut
Right hand													
3538796	235103	1.06	.44	-0.19	.75	.75	1.69	.25	5.98	5.963	4.475	606218	613137
3538797	235104	1.06	.44	-0.19	1.00	1.00	1.69	—	5.98	5.963	5.090	606218	613137
3538798	235105	1.06	.47	-0.19	1.25	1.25	1.94	—	5.98	5.963	5.090	606218	613137
Left hand													
3538799	235106	1.06	.44	-0.19	.75	.75	1.69	.25	5.98	5.963	4.475	606218	613137
3538800	235107	1.06	.44	-0.19	1.00	1.00	1.69	—	5.98	5.963	5.090	606218	613137
3538801	235108	1.06	.44	-0.19	1.25	1.25	1.94	—	5.98	5.963	5.090	606218	613137

NOTE: These holders can only use curve-out cartridge assembly.
Right-hand holder uses left-hand cartridge assembly.

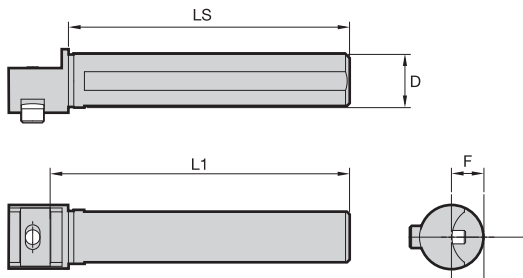

Left Hand Assembly

■ Round Shank

order number	catalog number	D	L1	LS	F	support blade screw	washer
3538803	235110	1.000	6.750	6.750	.763	619155	613135
3538802	235109	1.250	6.750	6.750	.763	619155	613135
3538794	235101	1.500	6.750	6.750	.763	619155	613135

NOTE: Toolholders can be used as left hand or right hand.
These holders can use curve-in and curve-out cartridge assembly.

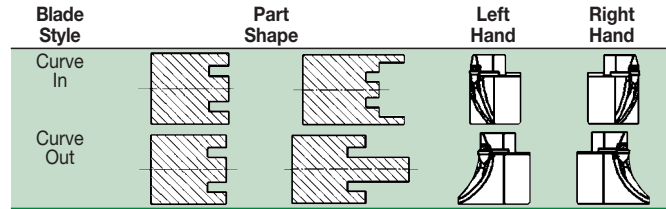
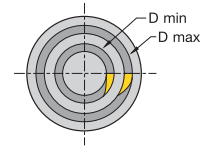
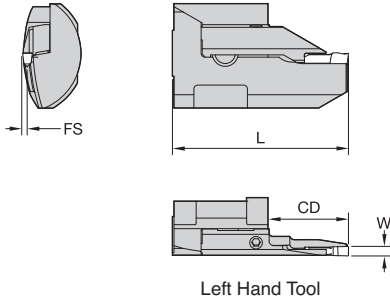

■ Curve In

order number	catalog number	W	CD	D min	D max	FS	L	hand	clamp	clamp screw
3539537	338123	.125	.75	2.25	15.75	-0.071	2.30	L - Left	440203	606219
3539538	338124	.188	1.00	2.25	15.75	-0.094	2.30	L - Left	440204	606219
3539546	338132	.250	1.00	2.25	15.75	-0.125	2.30	L - Left	4402122	606219
3539535	338121	.125	.75	2.25	15.75	-0.071	2.30	R - Right	440201M	606219
3539536	338122	.188	1.00	2.25	15.75	-0.094	2.30	R - Right	440202	606219
3539545	338131	.250	1.00	2.25	15.75	-0.125	2.30	R - Right	440211	606219

NOTE: RH cartridge goes with LH toolholder.
LH cartridge goes with RH toolholder.

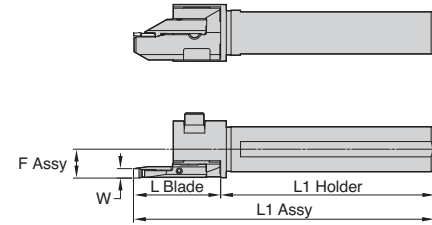

For Round Shank
 $F \text{ Assy} = W/2 + F \text{ (holder)} + FS \text{ (blade)}$
 $L1 \text{ Assy} = L1 \text{ (holder)} + L \text{ (blade)}$

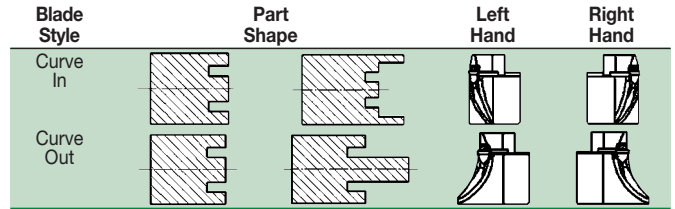
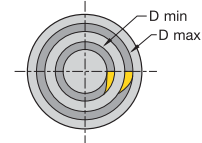
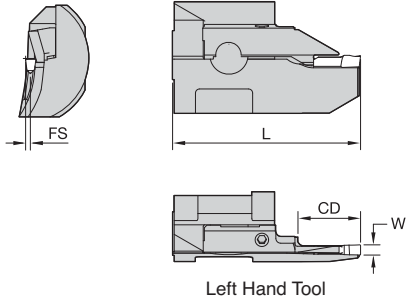

■ Curve Out

order number	catalog number	W	CD	D min	D max	FS	L	hand	clamp	clamp screw
3539539	338125	.125	.75	2.25	15.75	-0.058	2.30	L - Left	440205	606219
3539540	338126	.188	1.00	2.25	15.75	-0.094	2.30	L - Left	440206	606219
3539541	338127	.250	1.00	2.25	15.75	-0.125	2.30	L - Left	440207	606219
3539542	338128	.125	.75	2.25	15.75	-0.058	2.30	R - Right	440208	606219
3539543	338129	.188	1.00	2.25	15.75	-0.094	2.30	R - Right	440209	606219
3539544	338130	.250	1.00	2.25	15.75	-0.125	2.30	R - Right	440210M	606219

NOTE: RH cartridge goes with LH toolholder.
LH cartridge goes with RH toolholder.

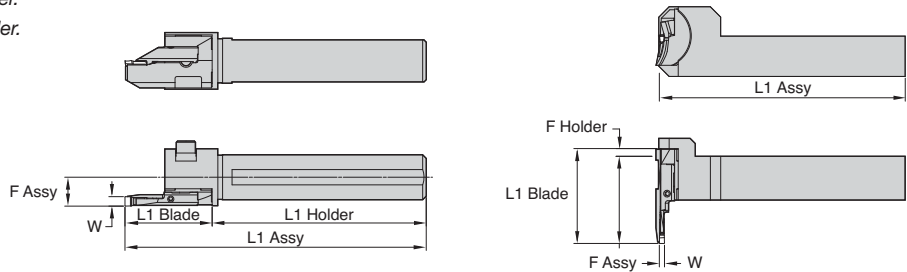

For Round Shank

$$F \text{ Assy} = W/2 + F \text{ (holder)} + FS \text{ (blade)}$$

$$L1 \text{ Assy} = L1 \text{ (holder)} + L1 \text{ (blade)}$$

For Square Shank

$$F \text{ Assy} = F \text{ (holder)} + L1 \text{ (blade)}$$

$$L1 \text{ Assy} = W/2 + L1 \text{ (holder)} + FS \text{ (blade)}$$

Grades and Grade Descriptions

Ranger™

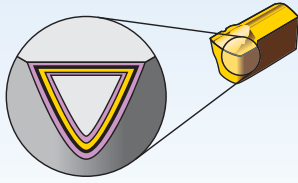

Coatings provide high-speed capability and are engineered for finishing to light roughing.

P	Steel
M	Stainless Steel
K	Cast Iron
N	Non-Ferrous Materials
S	High-Temp Alloys
H	Hardened Materials

Grade	Coating	Grade Description	Speed (ft/min)																				
			05	10	15	20	25	30	35	40	45												
C2	 HW-K15	A general-purpose tungsten carbide for use on cast irons, non-ferrous alloys, and many high-temperature alloys.	M																				
			K																				
			N																				
			S																				
GC	 HC-P15	Coated carbide. CVD — TiC-TiCN-TiN. Tri-phase coating on a hard, low binder content, fine-grained grade. High-speed, general-purpose grade for all kinds of steel. Gold in color.	P																				
			M																				
			K																				
			N																				
M40	 HC-P35	A premium, single-phase PVD TiN coating over a tough, specially formulated substrate that performs well under extremely low to moderate speed conditions found on screw machines. Ideal for carbon steels, alloy steels, most stainless steels, and many high-temperature alloys.	P																				
			M																				
			K																				
			N																				
M43	 HC-P30	PVD-TiAlN multi-layer coating over a tough, shock-resistant, fine-grained carbide substrate with increased oxidation resistance. Recommended on low to medium cutting speeds when good toughness properties are required.	P																				
			M																				
			K																				
			S																				

Ranger • Face Grooving



- Inserts available for plunge-groove and full-nose radii.
- Geometry design to provide clearance deep grooving.
- Superior chip control.

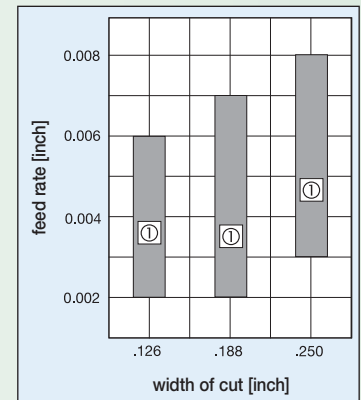

Ⓢ Recommended feed

ANSI ISO 513	VDI 3323	Cutting Speed • vc SFM											
Material Group		Cutting Speed • vc SFM											
		min	Start	max	min	Start	max	min	Start	max	min	Start	max
P		C2			GC			M40			M43		
	1				570	645	720	125	260	370	350	525	700
	2				490	560	630	110	220	330	280	455	630
	3				410	465	520	90	165	240	240	365	490
	4				460	500	540	100	195	290	260	405	550
	5				370	420	470	80	155	230	210	340	470
	6				460	500	540	100	195	290	260	405	550
	7				390	440	490	85	160	235	215	345	475
	8				340	395	450	75	150	220	200	330	455
	9				230	295	360	60	120	180	140	255	370
	10				360	395	430	80	155	230	210	305	400
	11				205	305	405	60	115	170	115	245	375
	12				450	510	570	120	225	330	280	395	510
	13.1				340	390	440	95	155	215	260	330	400
13.2				170	200	230	55	90	125	110	160	210	
M		C2			GC			M40			M43		
	14.1	160	190	220				100	145	190	170	250	330
	14.2	150	178	205				85	130	170	140	205	270
	14.3	125	140	155				70	95	120	110	160	210
14.4	90	105	120				50	75	100	85	125	165	
K		C2			GC			M40			M43		
	15	450	550	650				250	350	450	350	500	650
	16	375	440	500				170	265	360	250	375	500
	17	425	500	570				200	310	420	300	435	570
	18	300	375	450				150	240	330	200	325	450
	19	500	600	700				275	375	475	400	550	700
20	400	475	550				180	290	400	270	410	550	
N		C2			GC			M40			M43		
	21	1000	1350	1700				700	1200	1700	900	1450	2000
	22	800	1150	1500				500	1000	1500	700	1250	1800
	23	1000	1350	1700				700	1200	1700	900	1450	2000
	24	800	1150	1500				500	1000	1500	700	1250	1800
	25	700	800	900				450	675	900	600	850	1100
	26	500	550	600				300	450	600	400	550	700
	27	500	550	600				300	450	600	400	550	700
	28	300	350	400				200	300	400	250	350	450
	29	200	250	300				150	225	300	180	265	350
	30	250	300	350				150	250	350	200	300	400
S		C2			GC			M40			M43		
	31	120	145	170				90	125	160	100	140	180
	32	90	100	110				70	85	100	75	95	120
	33	70	75	80				45	60	75	50	70	90
	34	60	65	70				40	50	60	45	55	70
	35	60	65	70				40	50	60	45	55	70
	36	180	195	210				110	155	200	120	170	220
	37	90	100	110				60	80	100	75	95	115

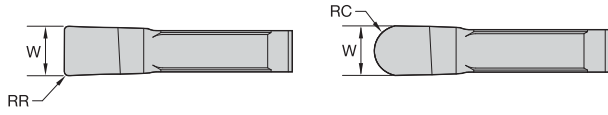

● first choice
○ alternate choice

P	●	○	●	●
M	●	○	●	●
K	●	○	●	●
N	●	○	●	●
S	●	○	○	○
H	○	○	○	○

■ Face Grooving

catalog number	W		RR		RC		C2	GC	M40	M43
	mm	in	mm	in	mm	in				
506101	3,18	.125	0,25	.010	—	—	●	●	●	●
506102	3,18	.125	0,25	.010	—	—	●	●	●	○
506104	3,18	.125	—	—	1,59	.063	●	○	●	○
506105	3,18	.125	—	—	1,59	.063	●	○	●	○
506103	4,78	.188	0,25	.010	—	—	●	●	○	●
506106	4,78	.188	—	—	2,39	.094	○	○	●	○
506107	6,35	.250	0,25	.010	—	—	○	○	●	○
506108	6,35	.250	—	—	3,18	.125	○	○	●	○

NOTE: Inserts 506101 and 506104 are to be used for counterclockwise rotation only.
Inserts 506102 and 506105 are to be used for clockwise rotation only.

Grooving, Cut-Off, and Turning • Ranger

Technical Recommendations • Ranger Tool Systems

Application Information:

- When changing inserts, be sure the new insert locates against the positive stop on the clamp.
- Never tighten the insert clamping screw without an insert in the pocket. Permanent damage to the clamp could occur.
- Toolholder projection length out of the tool block should be as short as possible to maintain rigidity.
- Slower speeds and feeds are recommended compared to OD grooving.

Face Grooving Ranges per Setting

given diameter setting	plunge range at diameter setting	
	smallest OD	largest OD
2-1/4	2-1/4	2-3/8
2-1/2	2-3/8	2-5/8
2-3/4	2-9/16	2-15/16
3.0	2-5/8	3-3/8
3-1/2	3-1/16	3-15/16
4.0	3-1/2	4-1/2
5.0	4-1/4	5-3/4
6.0	5	7
8.0	6-1/2	9-1/2
10.0	8	11
11-16	9	16

NOTE: This chart is a general guide for face groove entry at outside diameters both smaller and larger than each given OD setting on the tool.

Example: If the tool is adjusted for 4" OD, plunge cuts from 3-1/2" OD to 4-1/2" OD can be made without changing the 4" OD setting.

Widening a Face Groove

Additional clearance is generated on the workpiece after the first groove cut. Without further adjustment, the tool may then be used to widen the groove toward the center or the OD of the workpiece.

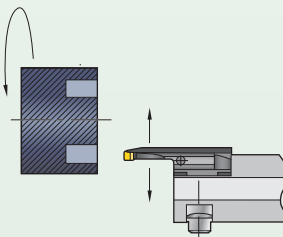

WMT™ Face Grooving Clearances

The cutting edge of the WMT face grooving system is +.030" above center to improve cutting clearances. This tool should not be repositioned on center. When facing toward center, this system does not have sufficient clearance to cut at <.850" diameters.

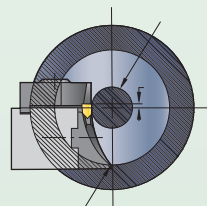

Adjusting Information for Ranger Tooling

The following instructions are for style 1 Ranger tools. Instructions for style 2 tools are in [brackets].

- Appropriate diameter range setting can be accomplished as follows:

Step 1 Loosen the support blade locking screw and rotate the support blade so that the 2.25 mark is above the top line on the toolholder. [Below the line on toolholder for style 2.]

2.25 diameter settings

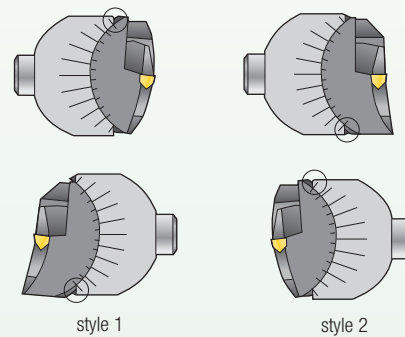

Step 2 Slowly rotate the support blade down until the 2.25 mark is aligned with the top line of the toolholder. [Rotate the support blade up until the 2.25 mark is aligned with the bottom line on the toolholder for style 2.] At this point, the support blade assembly is properly aligned to cut face grooves at 2.25" OD.

For diameters larger than 2.25" OD, continue to rotate the support blade in the same direction until the desired diameter range has been aligned.

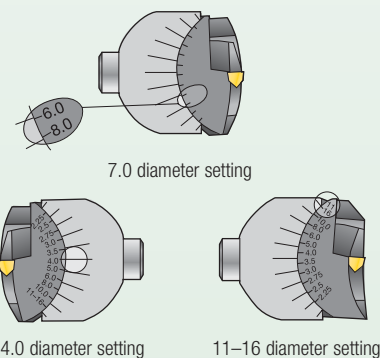

Example: The 7.0 diameter setting falls between the 6.0 and 8.0 diameter settings.

Step 3 Tighten the support blade screw. Inspect the scale to ensure that the desired diameter range is aligned.

NOTE: It is important that these instructions are followed. Failure to do so may result in damage to the tool and the workpiece.

S-LOC™

S-LOC • ID Boring, Grooving, Face Grooving, and Threading

Features and Benefits:

- Specifically for ID grooving and threading applications.
- Bar diameters range from .500" (12,5mm) to .750" (19,0mm).
- Maximum depth of cut .094" (2,39mm).

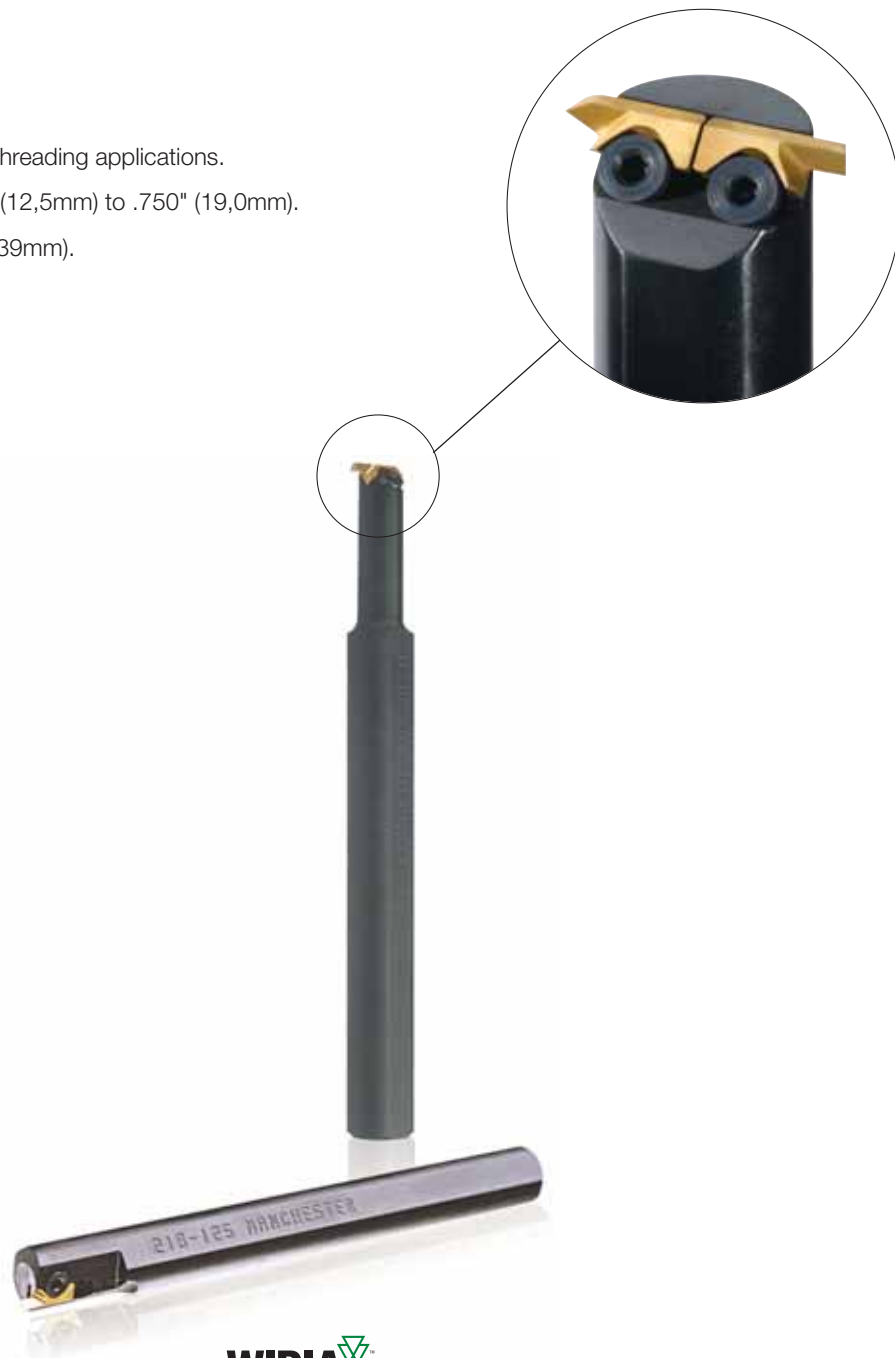

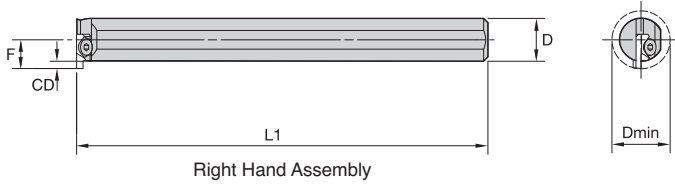

Right Hand Assembly

■ ID Grooving

order number	catalog number	CD	L1	D	F	D min	hand	clamp screw
3538777	218123	.094	6.004	.625	.419	.780	L - Left	606190
3636872	218119	.094	6.004	.500	.312	.560	N - Neutral	606190
3538775	218121	.094	6.004	.625	.312	.560	N - Neutral	606190
3538778	218124	.094	8.004	.750	.510	.940	N - Neutral	606190
3538776	218122	.094	6.004	.625	.419	.780	R - Right	606190

NOTE: Can be used with right- or left-hand inserts.
Right-hand assemblies use left-hand inserts.
218119, 218121, and 218124 may be used as either right- or left-hand holders.

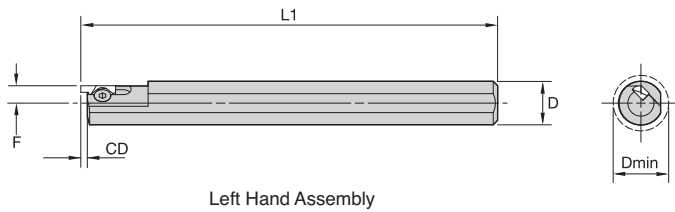

Left Hand Assembly

■ Face Grooving

order number	catalog number	CD	L1	D	F	D min	clamp screw
3538779	Right hand 218125	.094	6.000	.625	.250	.640	606190
	Left hand 218126	.094	6.000	.625	.250	.640	

NOTE: 1/2" and larger outside diameter.

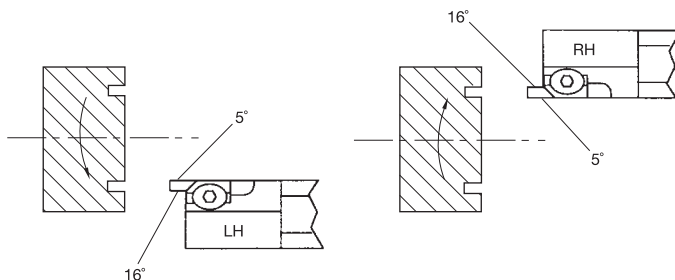

- Side clearance angles as noted.
- Use left-hand tooling for counterclockwise rotation only.
- Use right-hand tooling for clockwise rotation only.

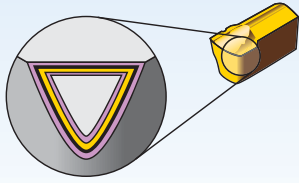

Coatings provide high-speed capability and are engineered for finishing to light roughing.

P	Steel
M	Stainless Steel
K	Cast Iron
N	Non-Ferrous Materials
S	High-Temp Alloys
H	Hardened Materials

Coating		Grade Description	05	10	15	20	25	30	35	40	45	
C2		A general-purpose tungsten carbide for use on cast irons, non-ferrous alloys, and many high-temperature alloys.										
	HW-K15											
	HW-P30											
C5		A general-purpose alloyed tungsten carbide for steel cutting.										
	HW-P30											
	HC-P15											
GC		Coated carbide. CVD — TIC-TiCN-TiN. Tri-phase coating on a hard, low binder content, fine-grained grade. High-speed, general-purpose grade for all kinds of steel. Gold in color.										
	HC-P15											
	HC-P35											
M40		A premium, single-phase PVD TiN coating over a tough, specially formulated substrate that performs well under extremely low to moderate speed conditions found on screw machines. Ideal for carbon steels, alloy steels, most stainless steels, and many high-temperature alloys.										
	HC-P35											
	HW-K15											

S-LOC



- Unique clamping surface on inserts.
- Used in ID boring and grooving applications.
- Superior chip control.

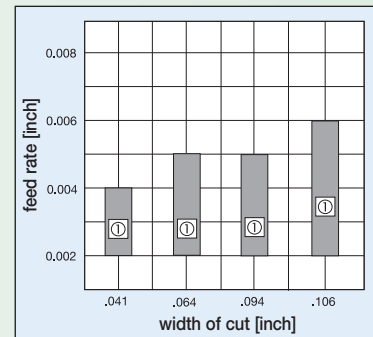

① Recommended feed

ANSI ISO 513	VDI 3323	Cutting Speed • vc SFM											
Material Group		Cutting Speed • vc SFM											
		min	Start	max	min	Start	max	min	Start	max	min	Start	max
P		C2			C5			GC			M40		
	1				300	400	500	570	645	720	125	260	370
	2				240	350	460	490	560	630	110	220	330
	3				210	275	340	410	465	520	90	165	240
	4				220	305	390	460	500	540	100	195	290
	5				190	270	350	370	420	470	80	155	230
	6				225	308	390	460	500	540	100	195	290
	7				190	270	350	390	440	490	85	160	235
	8				180	260	340	340	395	450	75	150	220
	9				125	198	270	230	295	360	60	120	180
	10				190	250	310	360	395	430	80	155	230
	11				105	188	270	205	305	405	60	115	170
	12				235	313	390	450	510	570	120	225	330
	13.1				220	260	300	340	390	440	95	155	215
13.2				100	140	180	170	200	230	55	90	125	
M		C2			C5			GC			M40		
	14.1	160	190	220							100	145	190
	14.2	150	178	205							85	130	170
	14.3	125	140	155							70	95	120
14.4	90	105	120							50	75	100	
K		C2			C5			GC			M40		
	15	450	550	650							250	350	450
	16	375	440	500							170	265	360
	17	425	500	570							200	310	420
	18	300	375	450							150	240	330
	19	500	600	700							275	375	475
20	400	475	550							180	290	400	
N		C2			C5			GC			M40		
	21	1000	1350	1700							700	1200	1700
	22	800	1150	1500							500	1000	1500
	23	1000	1350	1700							700	1200	1700
	24	800	1150	1500							500	1000	1500
	25	700	800	900							450	675	900
	26	500	550	600							300	450	600
	27	500	550	600							300	450	600
	28	300	350	400							200	300	400
	29	200	250	300							150	225	300
	30	250	300	350							150	250	350
S		C2			C5			GC			M40		
	31	120	145	170							90	125	160
	32	90	100	110							70	85	100
	33	70	75	80							45	60	75
	34	60	65	70							40	50	60
	35	60	65	70							40	50	60
	36	180	195	210							110	155	200
	37	90	100	110							60	80	100

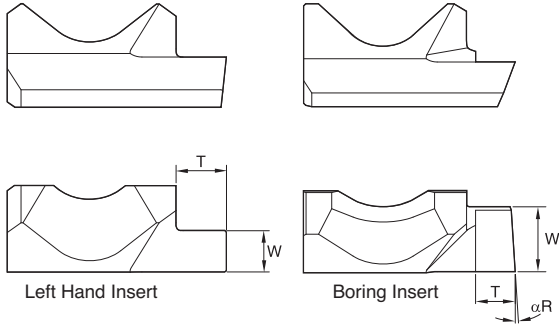

● first choice
○ alternate choice

P	●
M	●
K	○
N	●
S	○
H	○

■ ID Grooving

catalog number	W		T		αR	M40
	mm	in	mm	in		
Right hand						
510124	1,04	.041	2,08	.082	—	●
510128	1,63	.064	2,92	.115	—	●
510104	2,39	.094	2,92	.115	—	●
510132	2,50	.099	2,92	.115	—	●
510134	2,71	.107	2,92	.115	—	●
Left hand						
510113	1,04	.041	2,08	.082	—	●
510114	1,21	.048	2,08	.082	—	●
510115	1,36	.054	2,08	.082	—	●
510116	1,37	.057	2,08	.082	—	●
510117	1,63	.064	2,92	.115	—	●
510118	1,80	.071	2,92	.115	—	●
510119	1,94	.077	2,39	.094	—	●
510120	2,22	.088	2,92	.115	—	●
510101	2,39	.094	2,92	.115	—	●
510121	2,50	.099	2,92	.115	—	●
510122	2,64	.104	2,92	.115	—	●
510123	2,71	.107	2,92	.115	—	●
510102	3,81	.150	2,39	.094	4,00	●

NOTE: Insert 510102 is used for boring.

Grooving, Cut-Off, and Turning • S-LOC

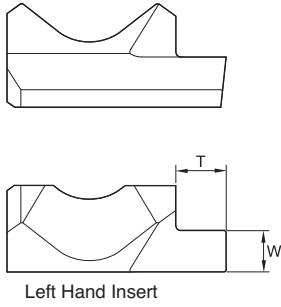

Left Hand Insert

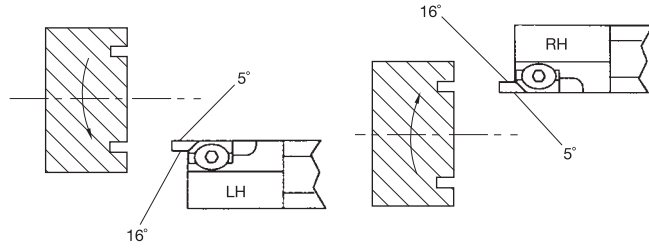

- Side clearance angles as noted.
- Use left-hand tooling for counterclockwise rotation only.
- Use right-hand tooling for clockwise rotation only.

- first choice
- alternate choice

P	●	●	●	●
M	●	●	●	●
K	○	○	○	○
N	●	●	●	●
S	○	○	○	○
H				

■ Face Grooving

catalog number	W		T		C2	C5	GC	M40
	mm	in	mm	in				
Right hand								
510136	1,98	.078	2,39	.094	●	●	●	●
510108	2,39	.094	2,39	.094	●			●
510138	2,59	.102	2,39	.094				●
Left hand								
510135	1,98	.078	2,39	.094		●		●
510107	2,39	.094	2,39	.094				●
510137	2,59	.102	2,39	.094				●

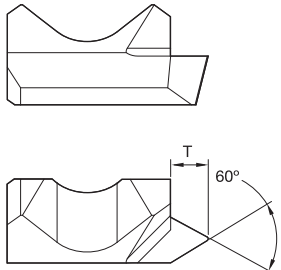

Left Hand Insert

■ Threading

catalog number	T		C2	C5	GC	M40
	mm	in				
Right hand						
510106	2,38	.094	●			●
Left hand						
510103	2,38	.094	●	●	●	●

NOTE: Minimum 10 threads per inch.

Grooving, Cut-Off, and Turning • S-LOC

Chipmaker™

Chipmaker • OD and ID Boring, Grooving, and Face Grooving

OD and ID Grooving Toolholders are specifically engineered with integral- and component-style toolholders, and single- and multi-edge Chipmaker grooving inserts, to provide a complete grooving portfolio.

- OD and ID grooving toolholders.
- Utilize double-ended “dog bone-style” inserts.
- Component toolholder systems.
- Contouring, and turning capabilities.
- Toolholder shank sizes 5/8"–1.50" (16,0mm–38,0mm).
- Grooving depths 5/16"–13/16" (7,94mm–19,0mm).
- Positive mechanical clamping system.
- Toolholders for straight OD and end mount applications.



OD and ID Grooving Inserts



- Double end, vee-bottom, mechanically clamped.
- .010"–.030" (0,3mm–0,6mm) corner radii and full nose radius.
- Multiple chip management geometries:
 - Flat-top with no chip geometry.
 - Flat-top with positive rake.
 - Molded bump and vee-chip control geometry.
 - Plow breaker-style chipbreaker.
- Various substrates — PVD and CVD coating.

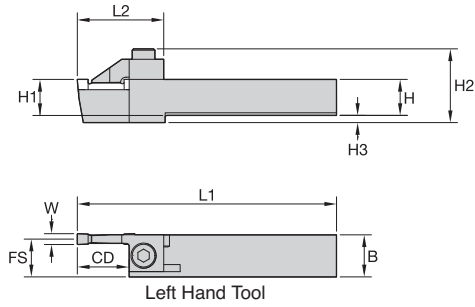

■ Square Shank

order number	catalog number	W	CD	H	B	H1	H2	H3	L1	L2	FS	clamp	clamp screw
Right hand													
3538825	236125	.126	.750	.625	.737	.625	1.274	.125	4.500	1.375	.687	441101	619168
3538819	236107	.126	.750	.750	.737	.750	1.274	—	5.000	1.375	.687	441101	619168
3538813	236101	.126	.750	1.000	.987	1.000	1.524	—	5.000	1.375	.937	441101	619168
3538826	236126	.188	.875	.625	.730	.625	1.280	.125	4.500	1.500	.656	441102	619168
3538820	236108	.188	.875	.750	.730	.750	1.280	—	5.000	1.500	.656	441102	619168
3538814	236102	.188	.875	1.000	.980	1.000	1.530	—	5.000	1.500	.906	441102	619168
3538821	236109	.250	.875	.750	.730	.750	1.280	—	5.000	1.500	.625	441102	619168
3538815	236103	.250	.875	1.000	.980	1.000	1.530	—	5.000	1.500	.875	441102	619168
Left hand													
3538827	236127	.126	.750	.625	.737	.625	1.274	.125	4.500	1.375	.687	441103	619168
3538822	236110	.126	.750	.750	.737	.750	1.274	—	5.000	1.375	.687	441103	619168
3538816	236104	.126	.750	1.000	.987	1.000	1.524	—	5.000	1.375	.937	441103	619168
3538828	236128	.188	.875	.625	.730	.625	1.280	.125	4.500	1.500	.656	441104	619168
3538823	236111	.188	.875	.750	.730	.750	1.280	—	5.000	1.500	.656	441104	619168
3538817	236105	.188	.875	1.000	.980	1.000	1.530	—	5.000	1.500	.906	441104	619168
3538824	236112	.250	.875	.750	.730	.750	1.280	—	5.000	1.500	.625	441104	619168
3538818	236106	.250	.875	1.000	.980	1.000	1.530	—	5.000	1.500	.875	441104	619168

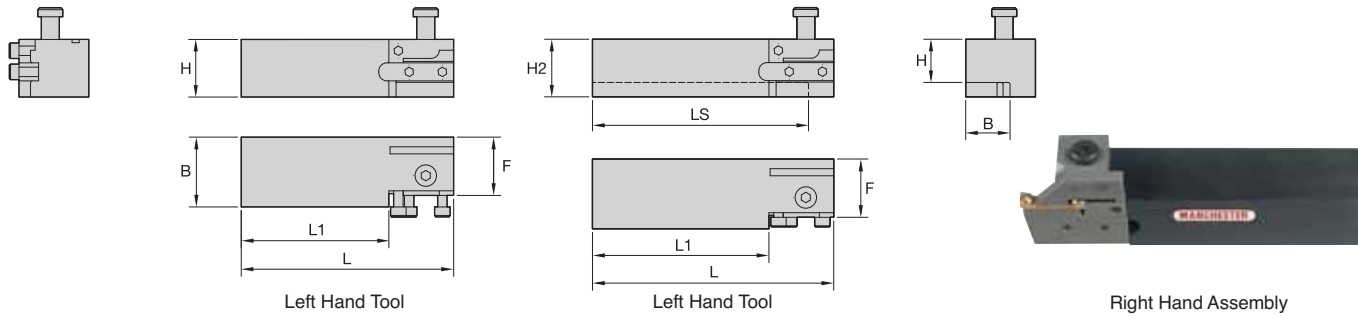

■ 5/16" and 1/2" Depth of Cut

order number	catalog number	B	H	H2	L1	LS	L	F	clamp screw	support blade screw
Right hand										
3538632	203344	.770	.750	1.000	3.063	3.750	4.188	1.012	619111	619102
3538631	203343	.770	.750	1.000	2.563	3.250	3.688	1.012	619111	619102
3563789	203235	1.212	1.250	—	4.563	4.563	5.688	1.012	619111	619102
3538624	203281	1.212	1.000	—	4.563	4.563	5.688	1.012	619111	619102
3634221	203223	1.212	1.000	—	3.563	3.563	4.688	1.012	619111	619102
3634219	203219	1.212	1.000	—	2.563	2.563	3.688	1.012	619111	619102
Left hand										
3538634	203346	.770	.750	1.000	3.063	3.750	4.188	1.012	619111	619102
3565414	203308	1.212	1.250	—	4.563	4.563	5.688	1.012	619111	619102
3634246	203234	1.212	1.000	—	2.563	2.563	3.688	1.012	619121	619102
3538622	203275	1.212	1.000	—	3.563	3.563	4.688	1.012	619111	619102
3538625	203285	1.212	1.000	—	4.563	4.563	5.688	1.012	619111	619102

■ Components for 5/16" Depth of Cut

W	L1	FS	left hand support blade	clamp	stop	clamp	right hand support blade
.126	1.437	.172	308123	407118	601101	407101	308106
.156	1.437	.157	308124	407119	601101	407102	308107M
.188	1.437	.141	308125	407120	601102	407103	308108
.250	1.437	.110	308126	407121	601102	407104	308109
.312	1.437	.192	308127	407122	601103	407105	308110

■ Components for 1/2" Depth of Cut

W	L1	FS	left hand support blade	clamp	stop	clamp	right hand support blade
.126	1.625	.172	308130	407124	601104	407107	308113
.156	1.625	.192	308143	407129	601104	407108	308114
.188	1.625	.157	308131	407125	601105	407109	308115
.250	1.625	.110	308137	407127	601105	407110	308116
.312	1.625	.192	308145	407130	601106	407111	308117

Grooving, Cut-Off, and Turning • Chipmaker

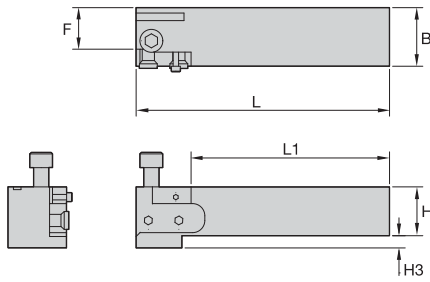

Right Hand Tool

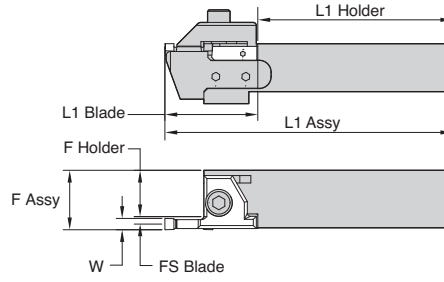

Right Hand Assembly
L1 Assy = L1 (holder) + L1 (blade)
F Assy = F (holder) + FS (blade) + W/2



Right Hand Assembly

■ 5/8" or 13/16" Depth of Cut

order number	catalog number	B	H	H3	L1	L	F	support blade screw	clamp screw
Right hand									
3634247	203287	1.199	1.000	.250	4.063	5.188	.850	606160	619110
3538619	203245	1.199	1.250	—	4.563	5.688	.850	606160	619110
3634244	203231	1.449	1.250	—	4.063	5.188	1.100	606160	619110
Left hand									
3538617	203112	1.949	1.500	—	4.563	5.688	1.600	606160	619110
3538640	203352	1.199	1.000	.250	4.063	5.188	.850	606160	619110
3538621	203271	1.449	1.250	—	3.813	4.938	1.100	606160	619110
3538618	203232	1.449	1.250	—	4.063	5.188	1.100	606160	619110
3634245	203233	1.949	1.500	—	4.563	5.688	1.600	606160	619110

■ Components for 5/8" Depth of Cut

W	L1	FS	left hand support blade	clamp	stop	clamp	right hand support blade
.126	1.750	.334	308148	407133	601112	407131	308146
.156	1.750	.319	308149	407134	601112	407132	308147

■ Components for 13/16" Depth of Cut

W	L1	FS	left hand support blade	clamp	stop	clamp	right hand support blade
.126	1.937	.303	308150	407135	601107	407113	308119
.250	1.937	.272	308151	407144	601107	407143	308120
.312	1.937	.241	308152	407137	601108	407115	308121
.376	1.937	.209	308153	407138	601108	407116	308122

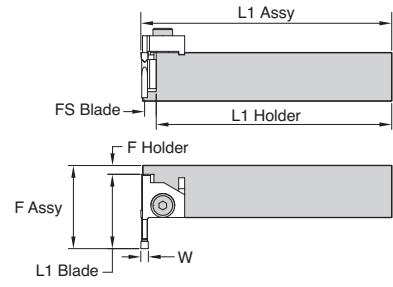
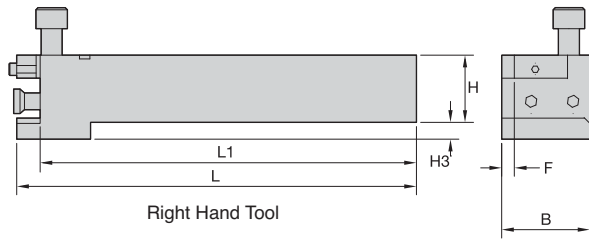

Right Hand Assembly

Left Hand Assembly

L1 Assy = L1 (holder) + FS (blade) + W/2
F Assy = F (holder) + L1 (blade)

■ Right Angle • 5/8" and 13/16" Depth of Cut

order number	catalog number	B	F	H	H3	L	L1	support blade screw	clamp screw	stop screw
Right hand										
3538653	204270	1.313	.188	1.000	.250	5.949	5.600	606160	619110	619101
3538644	204215	1.313	.188	1.250	—	5.949	5.600	606160	619110	619101
3538647	204259	1.500	.376	1.500	—	5.949	5.600	606160	619110	619101
Left hand										
3538652	204269	1.313	.188	1.000	.250	5.949	5.600	606160	619110	619101
3615158	204214	1.313	.188	1.250	—	5.949	5.600	606160	619110	619101
3538646	204258	1.500	.375	1.500	—	5.949	5.600	606160	619110	619101

■ Components for 5/8" Depth of Cut

W	L1	FS	left hand support blade	clamp	stop	clamp	right hand support blade
.126	1.750	.334	308148	407133	601112	407131	308146
.156	1.750	.319	308149	407134	601112	407132	308147

■ Components for 13/16" Depth of Cut

W	L1	FS	left hand support blade	clamp	stop	clamp	right hand support blade
.126	1.937	.303	308150	407135	601107	407113	308119
.250	1.937	.272	308151	407144	601107	407143	308120
.312	1.937	.241	308152	407137	601108	407115	308121
.376	1.937	.209	308153	407138	601108	407116	308122

NOTE: Use left-hand components in right-hand toolholders. Use right-hand components in left-hand toolholders.

Grooving, Cut-Off, and Turning • Chipmaker

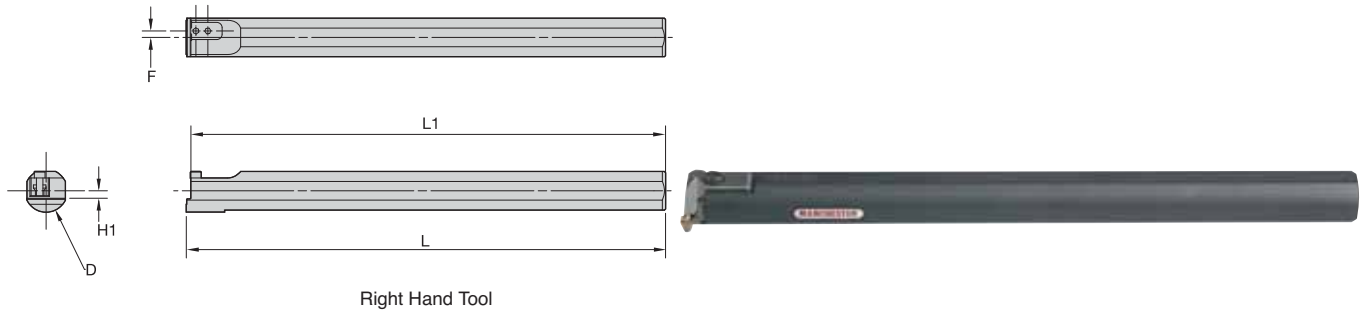

■ ID Grooving 1-1/4" Diameter

order number	catalog number	D	F	H1	L1	L	support blade screw	clamp screw
	Right hand							
3538648	204263	1.250	.188	-0.238	13.865	14.000	606192	619120
3538792	226262	1.260	.188	-0.238	13.865	14.000	606225	619152
	Left hand							
3538791	226261	.984	.000	-0.238	11.865	12.000	606225	619152
3563796	204262	1.000	.000	-0.238	11.865	12.000	606192	619120
3538649	204264	1.250	.188	-0.238	13.865	14.000	606192	619120
3538789	226252	1.260	.188	-0.238	13.865	14.000	606225	619152

NOTE: Toolholders 204261 and 204262 can be used as a right or left hand.
 Left-hand toolholders use right-hand components.
 Right-hand toolholders use left-hand components.
 Use inserts that have additional clearance for ID boring.

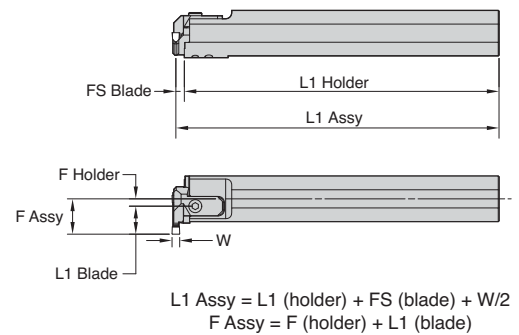

Grooving, Cut-Off, and Turning • Chipmaker

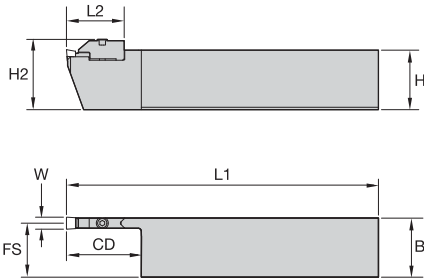

Left Hand Tool



Right Hand Assembly

■ **DAG Extended DOC**

order number	catalog number	W	CD	B	H	L1	L2	FS	H2	clamp	clamp screw
Right hand											
3538848	237101	.250	1.500	.980	.990	6.500	1.203	.875	1.214	442101	619170
3538852	237105	.250	1.500	1.230	1.240	6.500	1.203	1.125	1.464	442101	619170
3538849	237102	.313	1.500	.980	.990	6.500	1.229	.845	1.229	442102	619170
3538853	237106	.313	1.500	1.230	1.240	6.500	1.229	1.095	1.479	442102	619170
Left hand											
3538850	237103	.250	1.500	.980	.990	6.500	1.203	.875	1.214	442101	619170
3538854	237107	.250	1.500	1.230	1.240	6.500	1.203	1.125	1.464	442101	619170
3538851	237104	.313	1.500	.980	.990	6.500	1.229	.845	1.229	442102	619170
3538855	237108	.313	1.500	1.230	1.240	6.500	1.229	1.095	1.479	442102	619170

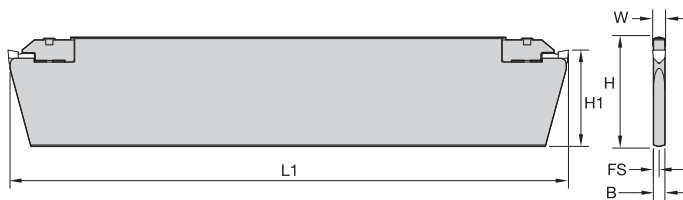

■ **DAG Blades**

order number	catalog number	W	L1	H	H1	FS	B	clamp	clamp screw
3539595	341101	.236	10.300	2.068	1.770	.106	.212	442101	619170
3539596	341102	.315	10.300	2.067	1.770	.135	.270	442102	619170

Grooving, Cut-Off, and Turning • Chipmaker

Chipmaker



First choice for chip control and reduced cutting forces for most materials. Precision width for deep grooving. Plunge and turn capable.

Positive Rake Inserts



Reduced cutting pressures versus neutral rake-style for deep grooving. Plunge and turn capable.

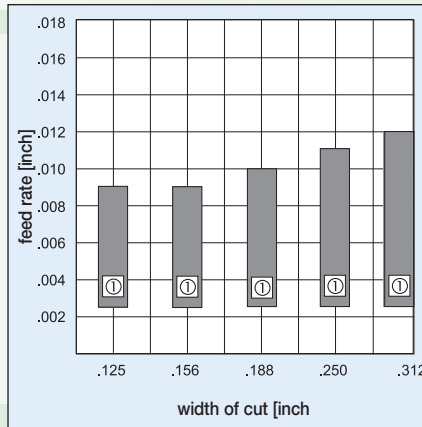

① Recommended feed

Neutral Rake Inserts



First choice for cast iron or other short chipping materials. Widest selection of corner radii. Precision width for deep grooving. Plunge and turn capable.

Chipmaker 95



Chip control for applications using aggressive feed rates to deliver productivity. Plunge mode only. Precision width for deep grooving.

ANSI ISO 513	VDI 3323	Cutting Speed • vc SFM														
Material Group		Cutting Speed • vc SFM														
		min	Start	max	min	Start	max	min	Start	max	min	Start	max	min	Start	max
P		GC			M40			M43			M45			M93		
	1	570	645	720	125	260	370	350	525	700	150	275	400	500	650	800
	2	490	560	630	110	220	330	280	455	630	140	250	360	425	550	700
	3	410	465	520	90	165	240	240	365	490	115	190	265	360	475	570
	4	460	500	540	100	195	290	260	405	550	130	225	320	400	490	600
	5	370	420	470	80	155	230	210	340	470	100	175	250	325	425	520
	6	460	500	540	100	195	290	260	405	550	130	225	320	400	500	600
	7	390	440	490	85	160	235	215	345	475	110	175	245	340	440	540
	8	340	395	450	75	150	220	200	330	455	90	160	230	300	400	500
	9	230	295	360	60	120	180	140	255	370	70	135	200	200	300	400
	10	360	395	430	80	155	230	210	305	400	100	170	240	320	400	475
	11	205	305	405	60	115	170	115	245	375	70	130	190	180	320	450
	12	450	510	570	120	225	330	280	395	510	130	245	360	390	505	620
	13.1	340	390	440	95	155	215	260	330	400	110	180	250	295	390	490
13.2	170	200	230	55	90	125	110	160	210	65	100	140	150	200	250	
M					M40			M43			M45			M93		
	14.1				100	145	190	170	250	330	110	165	220	295	390	490
	14.2				85	130	170	140	205	270	105	155	205	245	325	390
	14.3				70	95	120	110	160	210	85	120	155	180	245	310
14.4				50	75	100	85	125	165	60	90	120	145	195	245	
K		M24			M40			M43			M45			M93		
	15	750	950	1150	250	350	450	350	500	650	300	400	500	500	650	800
	16	550	750	950	170	265	360	250	375	500	200	325	450	350	500	650
	17	650	850	1050	200	310	420	300	435	570	230	360	490	400	550	700
	18	600	800	1000	150	240	330	200	325	450	175	275	375	375	525	675
	19	800	1000	1200	275	375	475	400	550	700	320	420	520	550	590	850
20	700	900	1100	180	290	400	270	410	550	210	340	470	360	460	700	
N					M40			M43			M45			M93		
	21				700	1200	1700	900	1450	2000	800	1300	1800	1000	1600	2200
	22				500	1000	1500	700	1250	1800	600	1100	1600	800	1400	2000
	23				700	1200	1700	900	1450	2000	800	1300	1800	1000	1600	2200
	24				500	1000	1500	700	1250	1800	600	1100	1600	800	1400	2000
	25				450	675	900	600	850	1100	500	750	1000	700	1000	1300
	26				300	450	600	400	550	700	350	500	650	500	650	800
	27				300	450	600	400	550	700	350	500	650	500	650	800
	28				200	300	400	250	350	450	225	325	425	300	450	600
	29				150	225	300	180	265	350	150	240	325	200	300	400
	30				150	250	350	200	300	400	175	275	375	250	400	500
S					M40			M43			M45			M93		
	31				90	125	160	100	140	180	100	135	170	120	170	220
	32				70	85	100	75	95	120	75	90	110	95	115	150
	33				45	60	75	50	70	90	50	65	80	75	90	115
	34				40	50	60	45	55	70	45	55	70	60	75	90
	35				40	50	60	45	55	70	45	55	70	60	75	90
	36				110	155	200	120	170	220	120	165	210	180	220	260
	37				60	80	100	75	95	115	75	90	110	95	115	145

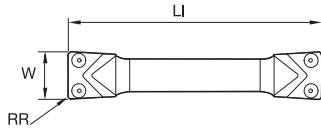

- first choice
- alternate choice

P	●	○	●	●	●	●	●
M	●	●	●	●	●	●	●
K	●	●	●	●	●	●	●
N	●	●	●	●	●	●	●
S	●	○	●	●	●	●	○
H	●	●	●	●	●	●	●

Chipmaker

catalog number	W		RR		LI		GC	M24	M40	M43	M45	M53	M83
	mm	in	mm	in	mm	in							
508238	3,20	.126	0,25	.010	22,23	.875	●	●	●	●	●	●	●
508250	3,20	.126	0,25	.010	22,23	.875	●	●	●	●	●	●	●
508244	3,20	.126	0,76	.030	22,23	.875	●	●	●	●	●	●	●
508245	3,96	.156	0,76	.030	22,23	.875	●	●	●	●	●	●	●
508251	4,78	.188	0,25	.010	25,40	1.000	●	●	●	●	●	●	●
508239	4,78	.188	0,25	.010	25,40	1.000	●	●	●	●	●	●	●
508246	4,78	.188	0,76	.030	25,40	1.000	●	●	●	●	●	●	●
508240	6,35	.250	0,25	.010	25,40	1.000	●	●	●	●	●	●	●
508252	6,35	.250	0,25	.010	25,40	1.000	●	●	●	●	●	●	●
508247	6,35	.250	0,76	.030	25,40	1.000	●	●	●	●	●	●	●
508242	7,93	.312	0,25	.010	28,58	1.125	●	●	●	●	●	●	●
508248	7,93	.312	0,76	.030	28,58	1.125	●	●	●	●	●	●	●
508243	9,55	.376	0,25	.010	28,58	1.125	●	●	●	●	●	●	●
508249	9,55	.376	0,76	.030	28,58	1.125	●	●	●	●	●	●	●

NOTE: 508250, 508251, and 508252 have additional clearance for ID Boring.

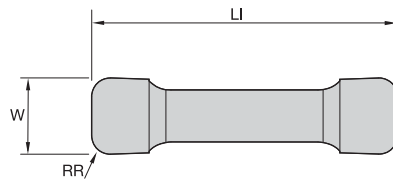
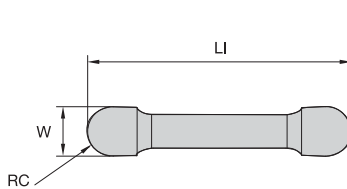

OD Neutral

catalog number	W		RR		RC		LI		GC	M24	M40	M43	M45	M53	M83
	mm	in	mm	in	mm	in	mm	in							
508301	3,20	.126	0,25	.010	—	—	22,23	.875	●	●	●	●	●	●	●
508307	3,20	.126	0,76	.030	—	—	22,23	.875	●	●	●	●	●	●	●
508313	3,20	.126	—	—	1,60	.063	22,23	.875	●	●	●	●	●	●	●
508302	3,96	.156	0,25	.010	—	—	22,23	.875	●	●	●	●	●	●	●
508314	3,96	.156	—	—	1,98	.078	22,23	.875	●	●	●	●	●	●	●
508303	4,78	.188	0,25	.010	—	—	25,40	1.000	●	●	●	●	●	●	●
508309	4,78	.188	0,76	.030	—	—	25,40	1.000	●	●	●	●	●	●	●
508315	4,78	.188	—	—	2,39	.094	25,40	1.000	●	●	●	●	●	●	●
508304	6,35	.250	0,25	.010	—	—	25,40	1.000	●	●	●	●	●	●	●
508340	6,35	.250	1,52	.060	—	—	25,40	1.000	●	●	●	●	●	●	●
508316	6,35	.250	—	—	3,18	.125	25,40	1.000	●	●	●	●	●	●	●

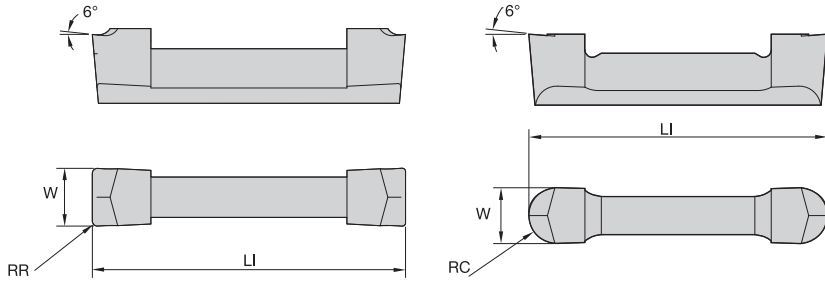

● first choice
○ alternate choice

P	○	●	●	●	●	●	●	●	●
M	●	●	●	●	●	●	●	●	●
K	●	●	●	●	●	●	●	●	●
N	●	●	●	●	●	●	●	●	●
S	○	●	●	●	●	●	●	○	●
H	●	●	●	●	●	●	●	●	●

■ **Chipmaker 95**

catalog number	W		RR		RC		LI		GC	M24	M40	M43	M45	M53	M93
	mm	in	mm	in	mm	in	mm	in							
508403	3,20	.126	0,25	.010	—	—	22,23	.875			●			●	
508404	3,20	.126	0,76	.030	—	—	22,23	.875			●			●	
508405	3,20	.126	—	—	1,60	.063	22,23	.875			●			●	
508412	4,78	.188	0,25	.010	—	—	25,40	1.000			●			●	
508413	4,78	.188	0,76	.030	—	—	25,40	1.000			●			●	
508422	6,35	.250	0,25	.010	—	—	25,40	1.000			●			●	
508423	6,35	.250	0,76	.030	—	—	25,40	1.000			●			●	
508424	6,35	.250	1,52	.060	—	—	25,40	1.000			●			●	

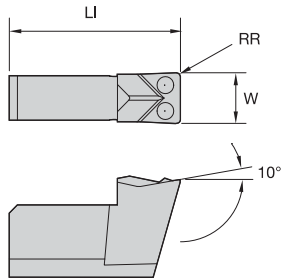

■ **DAG • Grooving and Cut-Off**

catalog number	W		RR		LI	
	mm	in	mm	in	mm	in
507172	3,20	.126	0,25	.010	10,77	.424
507182	6,35	.250	0,25	.010	12,34	.486
507183	6,35	.250	0,76	.030	12,34	.486
507185	7,93	.312	0,25	.010	13,95	.549
507186	7,93	.312	0,76	.030	13,95	.549

NOTE: 507172 has additional clearance for ID Boring.

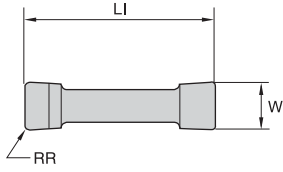

- first choice
- alternate choice

P			
M			
K	●		
N			
S			
H			●

■ CBN

catalog number	W		RR		LI		CBNGI	CBNHT
	mm	in	mm	in	mm	in		
528301	3,18	.125	0,25	.010	22,23	.875	●	●
528325	4,78	.188	0,76	.030	25,40	1.000	●	●
528303	4,78	.188	0,25	.010	25,40	1.000	●	●

Grooving, Cut-Off, and Turning • Chipmaker