

_INNOVATIONS

Groundbreaking products to move you forward.



Sharpening your cutting edge.



Why not take your technology to the next level? It's easy with solutions that are leaps ahead of the standard. That's because each of our innovations represents our collective experience and engineering expertise – just what's needed to boost your productivity and your cutting edge.

walter-tools.com

 **WALTER**
Engineering Kompetenz

“We do not **reinvent**
the wheel every day.

But we do **when it**
makes sense.”



Technologies at Walter.

Tiger-tec® Silver

With Tiger-tec® Silver, Walter offers a coating technology for indexable inserts that is unique worldwide, recognisable by the designation key "-S" at the end of the grade description: The special aluminium oxide layer with optimised microstructure reduces wear during turning, milling and drilling operations, and increases toughness and temperature resistance at the same time. This enables users to achieve significantly higher cutting data.

Walter BLAXX

Walter BLAXX is the benchmark for a new generation of milling cutters: The milling bodies are extremely robust thanks to their manufacturing process and special surface treatment. The milling systems, which are of tangential insert orientation in the main, are equipped with Tiger-tec® Silver indexable inserts. Tools with the Walter BLAXX designation combine the highest possible wear resistance with unbeatable performance data.



Walter Capto™ is a modular tool body adaptor system. It is suitable for all turning, milling, drilling and threading processes. Its ISO-standardised polygon taper absorbs torsional and bending moments extremely well and ensures optimal repeat accuracy.



Walter ConeFit is an extremely flexible solid carbide milling system with a wide range of high-performance replaceable heads and shank variants. Its conical thread is self centring, thereby guaranteeing maximum stability and concentricity.



Walter ScrewFit users benefit from maximum flexibility. Its modular interface is suitable for a wide variety of spindle adaptors and a wide range of tool diameters and lengths for milling and drilling.



The Walter precision cooling system provides cooling at the centre of chip formation. Its dual coolant jets are directed precisely onto the flank face and rake face. This system provides significantly increased tool life, improved chip breaking and greater efficiency for turning and grooving applications.

Walter Green

Walter Green: Sustainability and responsible use of resources are central components of our company principles. We use our "Walter Green" seal to show how we implement these principles, such as by offsetting our CO₂ emissions with environmental conservation projects. The result is highly efficient machining solutions that work in harmony with nature and the environment.

TURNING	Walter	
	ISO turning	4
	Grooving	8
	Order pages	10
	Technical appendix	30
DRILLING	Walter Titex	
	Solid carbide drills	32
	Walter	
	Indexable insert drills	36
	Walter Titex	
	Order pages	38
	Walter	
	Order pages	45
	Technical appendix	50
	THREADING	Walter Prototyp
Taps		52
Order pages		54
MILLING	Walter Prototyp	
	Solid carbide cutters	58
	Order pages	63
	Walter	
	Face, shoulder and slot milling cutters	84
	Order pages	90
Technical appendix	106	
GENERAL	Walter product lines	110
	Walter Reconditioning Service	111
	Alphanumeric index	112

Walter's new order code:
Scan this QR code or go directly
to <http://goo.gl/asvBQn>



Watch the innovations video:
Scan this QR code or go directly
to <http://goo.gl/t1XcwN>



RM5 coolant jet guiding geometry – maximum cooling and tool life with ISO M & ISO S.

NEW FOR 2016

THE APPLICATION

- ISO M stainless steels:
Austenitic (DIN 1.4571/AISI 316Ti),
Duplex steels (DIN 1.4462/AISI 318 LN),
Superaustenitic (DIN 1.4539/AISI 904L)
- ISO S high-temperature alloys

Machining parameters:

- f : 0.2–0.6 mm
- a_p : 1.0–5.0 mm

THE GEOMETRY

- Coolant jet guiding geometry for optimum internal coolant supply beneath the chip
- Basic shapes: CNMG, DNMG, TNMG, WNMG
- Tiger-tec® Silver PVD Al_2O_3 cutting tool materials: WSM10S, WSM20S, WSM30S
- Tiger-tec® Silver CVD cutting tool material: WMP20S

THE TOOL

- Walter Turn turning toolholder with lever-type, rigid or wedge-type clamping system
- Walter Turn turning toolholder with precision cooling



Powered by
Tiger-tec® Silver



Grades: WSM10S, WSM20S, WSM30S

Fig.: RM5 geometry

BENEFITS FOR YOU

- Optimal cooling and maximum productivity
- The design of the cutting edges reduces notch formation and crater wear
- Tiger-tec® Silver coating with PVD Al_2O_3 heat shield for maximum tool life
- For universal use in standard ISO turning toolholders or tools with Walter precision cooling toolholders



THE SYSTEM

Precision cooling:

In tools with precision cooling, the adaptor, the turning toolholder and the indexable insert geometry are designed to ensure ideal cooling.

The new RM5 jet guiding geometry directs the coolant beneath the chip – and thereby even closer to the cutting edge.

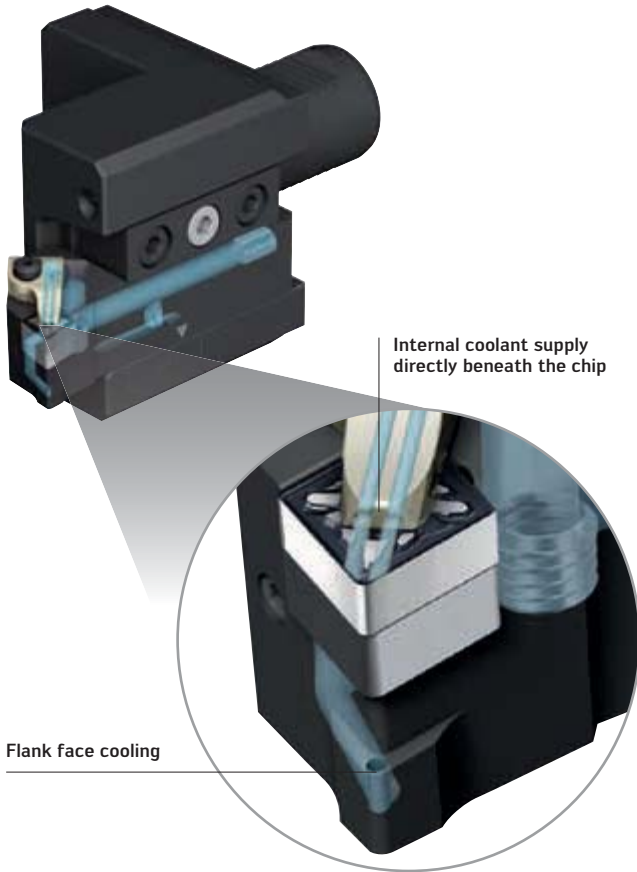

DCLN-P shank tool, A2120-P VDI adaptor and RM5 coolant jet guiding geometry

Ordering information from page 10.

APPLICATION EXAMPLE

Roughing – flange outer contour, forged

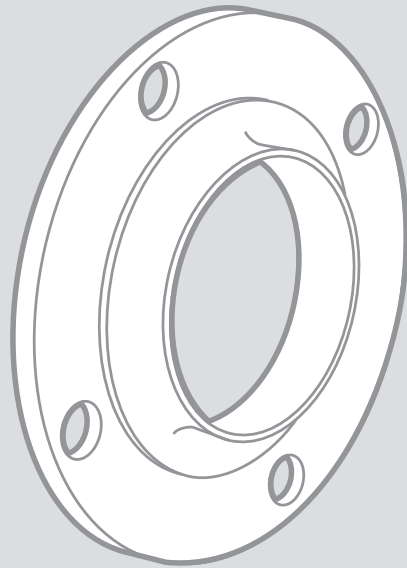

Material: 1.4404 (X2CrNiMo17-12-2)
Machine: Index C200
Operation: Roughing, outer contour
Insert: CNMG120412-RM5
Cutting material: Tiger-tec® Silver WSM20S

Cutting data:

	Competitors	Walter Test 1	Walter Test 2
Toolholder	C5-PCLNL35060-12 standard turning toolholder	C5-PCLNL35060-12 standard turning toolholder	C5-DCLNL35060-12-P precision cooling toolholder
Geometry	MRR	RM5	RM5
Grade	2015	WSM20S	WSM20S
v_c	180 m/min	180 m/min	180 m/min
f	0.35 mm	0.35 mm	0.35 mm
a_p	1.0–4.0 mm	1.0–4.0 mm	1.0–4.0 mm
Tool life	70	110	160

Comparison of the number of components:

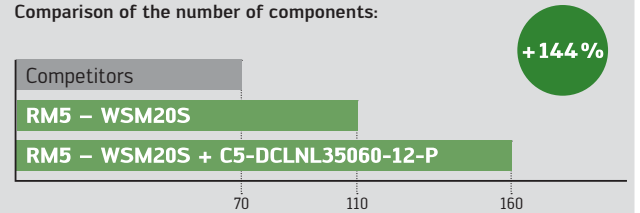

Watch product animation:
 Scan this QR code or go directly to <http://goo.gl/H1guhe>



Tiger-tec® Silver PVD – new grades with maximum toughness and wear resistance.

NEW TO THE RANGE

NEW ADDITION TO THE PRODUCT RANGE

Additional sizes and corner radii for:

- FM4, MM4 and RM4 positive geometries

The new grades:

- WSM10S, WSM20S, WSM30S

THE APPLICATION

Primary application:

ISO M – stainless steels

- Austenitic stainless steels (e.g. 1.4571/AISI 316Ti)
- Duplex steels

ISO S – high-temperature alloys

- Nickel-based alloys (e.g. Inconel 718)
- Cobalt-based alloys

Secondary application:

ISO P – steel

THE GEOMETRIES

- FM4: Finishing and fine machining
- MM4: Easy-cutting, universal machining
- RM4: Medium machining and roughing operations

THE TECHNOLOGY

Tiger-tec® Silver PVD

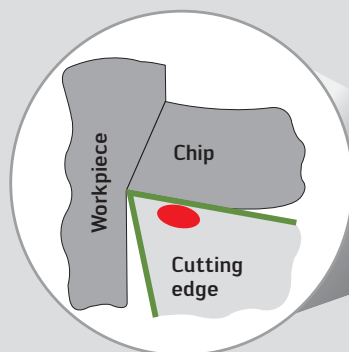

Low transfer of heat into the carbide thanks to Al₂O₃ heat shield

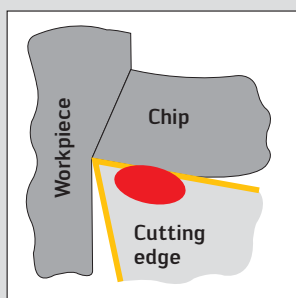

Competitors

High transfer of heat into the carbide due to conventional PVD layer



-  = Temperature
-  = Aluminium oxide (Al₂O₃)
-  = Conventional PVD coating

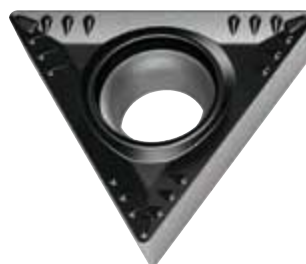

Powered by
Tiger-tec® Silver

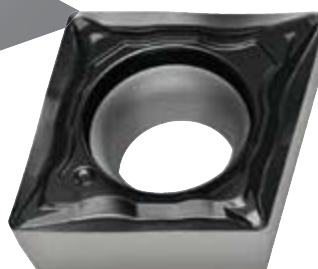

Fig.: FM4, RM4 and MM4 geometries

BENEFITS FOR YOU

- Maximum toughness thanks to minimal thermal loads with the newly developed coating process
- Reduced friction thanks to extremely smooth rake face
- Excellent chip breaking
- High wear resistance thanks to optimised Al₂O₃
- Burr-free components and reduced workpiece material build up on the edge

Overview of the Tiger-tec® Silver cutting tool materials and geometries.

PRODUCT RANGE OVERVIEW

ISO P

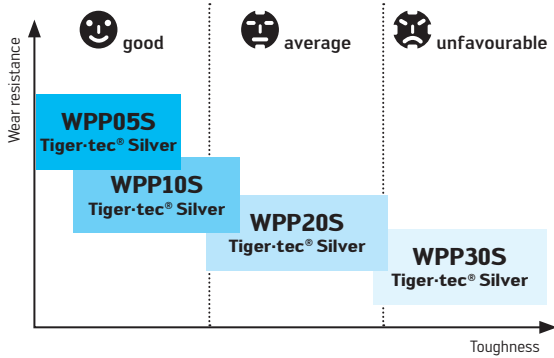

Negative basic shape

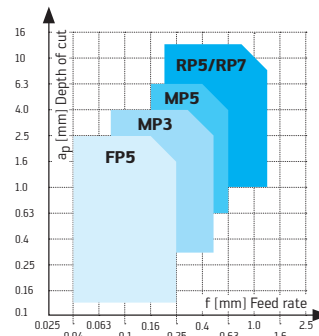

Positive basic shape

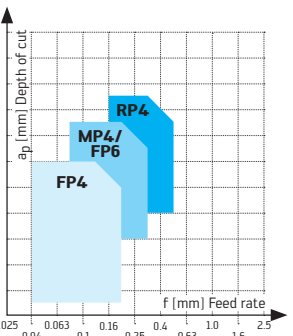

ISO K

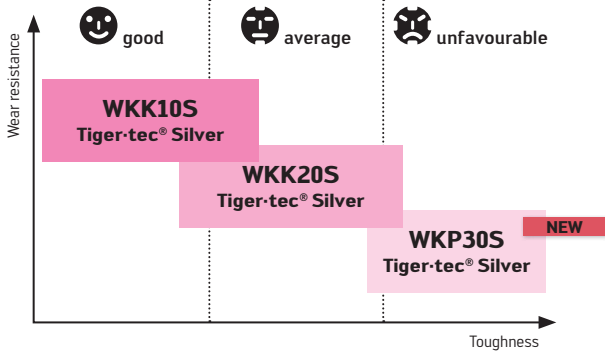

Negative basic shape

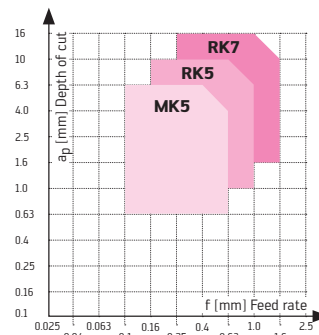

Positive basic shape

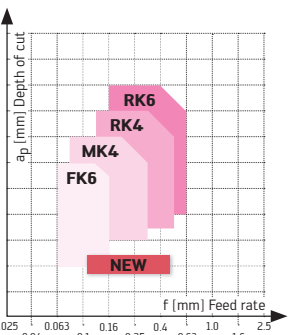

ISO M/S

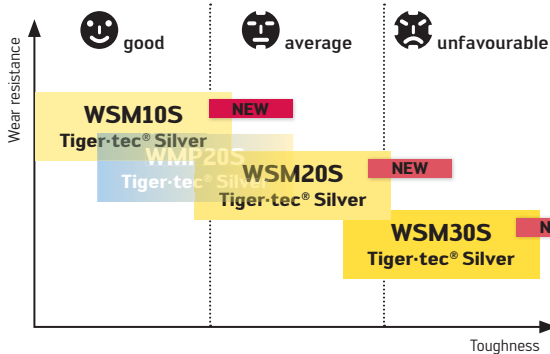

Negative basic shape

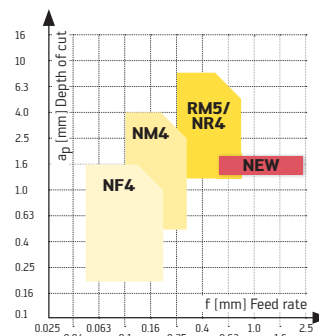

Positive basic shape

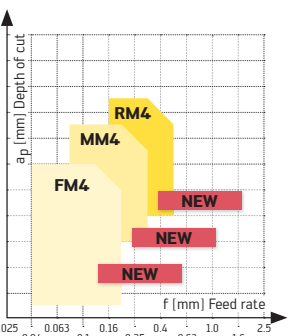

Ordering information from page 10.

Walter Cut G1511-P tool holder: With precision cooling, for universal use.

NEW FOR 2016

THE TOOL

- G1511-P in the following sizes: 16 × 16 mm, 20 × 20 mm and 25 × 25 mm
- For GX insert widths from 0.6 mm to 6.35 mm
- 4 mm cutting depth with GX16 inserts, up to 6 mm cutting depth with GX24 inserts

THE APPLICATION

- Grooving and recessing with precision cooling in radial and axial machining directions
- Can be used from 10 bar up to a maximum coolant pressure of 150 bar
- Can be used on all types of lathes

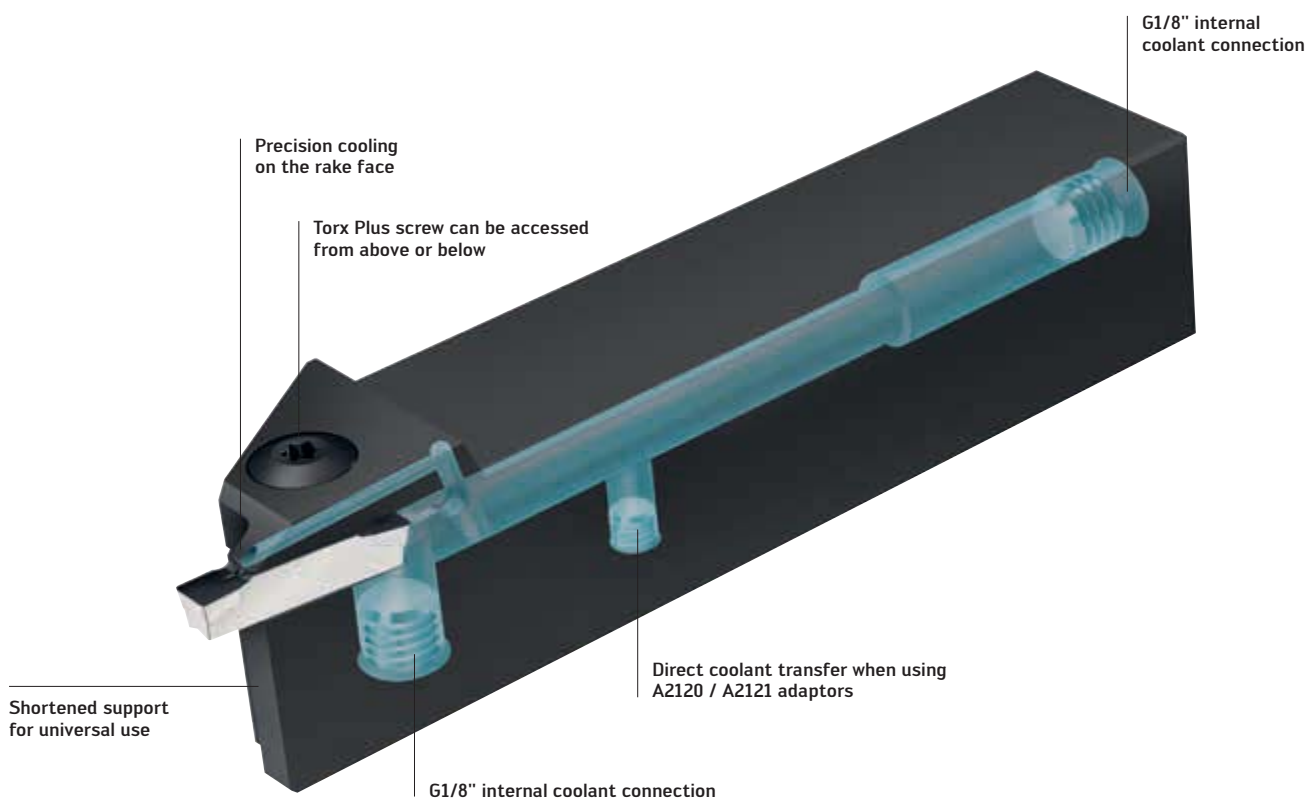

GX monoblock tool with precision cooling

Fig.: G1511-P

Ordering information
from page 26.



Watch product animation:
Scan this QR code or go directly
to <http://goo.gl/UDD6C1>

BENEFITS FOR YOU

- Universal use – carry out radial and axial grooving operations with a single tool, without loss of stability
- Suitable for universal use with all cutting edges from 0.6 mm to 6.35 mm
- Longer tool life and higher productivity
- Optimum cooling directly in the cutting zone starting from a coolant pressure as low as 10 bar
- Low head height for perfect chip evacuation

Walter Cut G1041-P: Reinforced contra parting blades with precision cooling.

NEW FOR 2016

THE TOOL

- G1041..R/L-C-P parting blades with reinforced shank and precision cooling
- Blade heights 26–32 mm
- Grooving widths 2–4 mm
- Diameter up to 65 mm
- Available in right-hand and left-hand contra version

THE APPLICATION

- Parting off operations where space is limited
- Parting off using long tool projections
- First choice when using parting blades
- Can be used from 10 bar up to a maximum coolant pressure of 80 bar

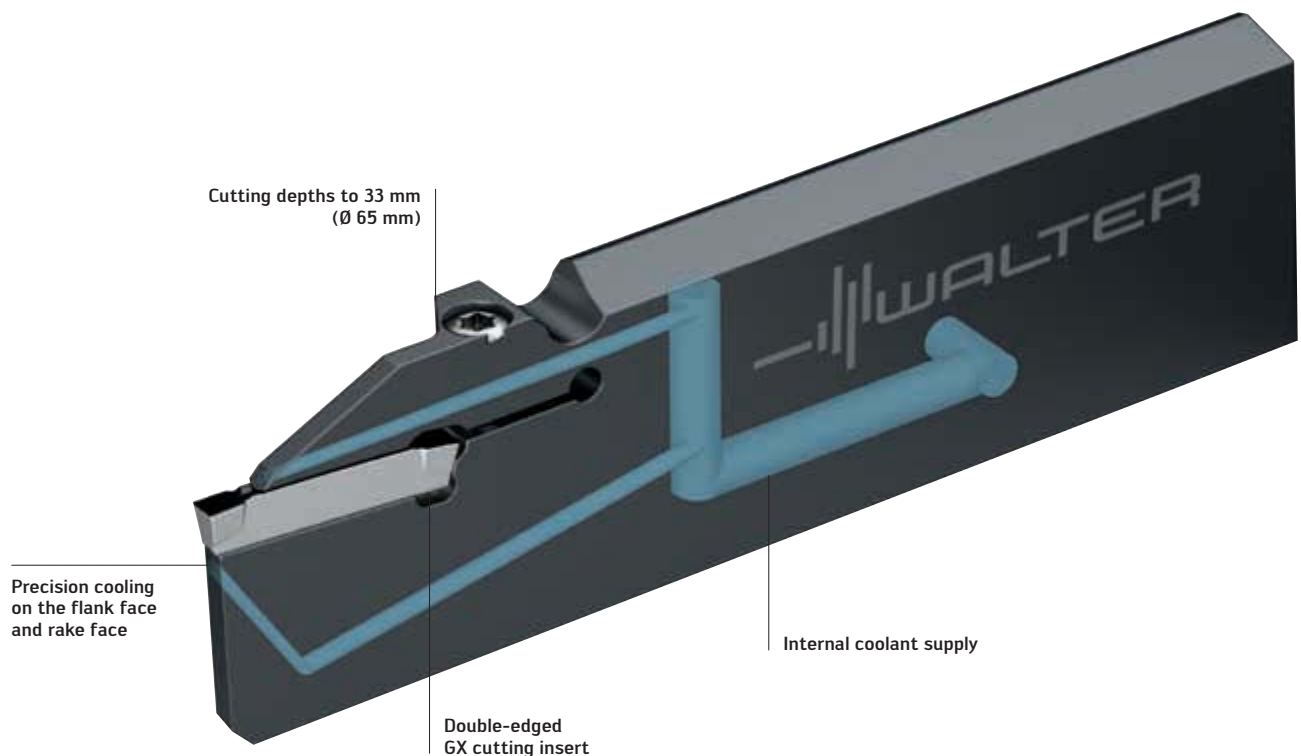

Reinforced blade with precision cooling

Fig.: G1041 ..R/L-C-P

BENEFITS FOR YOU

- Longer tool life and higher productivity
- Optimum cooling directly in the cutting zone starting from a coolant pressure as low as 10 bar
- Perfect chip control through precision cooling
- Reduced vibration tendency thanks to reinforced shank

Ordering information from page 28.



Watch product animation:
Scan this QR code or go directly to <http://goo.gl/UDD6C1>

Negative rhombic 80° CNMG Tiger-tec® Silver

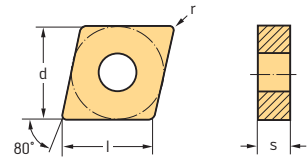

Indexable inserts

Designation	r mm	f mm	a _p mm	P							M						K			S							
				HC							HC						HC			HC							
				WPP01	WPP05S	WPP10S	WPP20S	WPP30S	WMP20S	WMP20S	WSM10S	WSM20S	WSM30S	WSM10	WSM20	WSM30	WKK10S	WKK20S	WKP30S	WSM10S	WSM20S	WSM30S	WSM10	WSM20	WSM30		
 Wiper	CNMG120404-NF	0,4	0,10–0,40	0,4–2,0	☺		☺	☹									☹										
	CNMG120408-NF	0,8	0,15–0,55	0,5–3,0	☺		☺	☹										☹									☹
	CNMG120404-MP5	0,4	0,16–0,25	0,5–4,0	☹	☺	☺	☹																			
	CNMG120408-MP5	0,8	0,18–0,40	0,6–5,0	☺	☺	☺	☹										☹									
	CNMG120412-MP5	1,2	0,20–0,45	1,0–5,0	☺	☺	☺	☹																			
	CNMG120416-MP5	1,6	0,25–0,50	1,2–5,0			☺	☺	☹																		
	CNMG160608-MP5	0,8	0,25–0,50	0,8–7,0	☺	☺	☺	☹																			
	CNMG160612-MP5	1,2	0,30–0,50	1,0–7,0	☺	☺	☺	☹																			
	CNMG160616-MP5	1,6	0,35–0,55	1,2–7,0			☺	☺	☹																		
	CNMG120408-RM5	0,8	0,20–0,40	1,2–5,0					☹	☹	☹	☹	☹							☹	☹	☹	☹				
	CNMG120412-RM5	1,2	0,25–0,50	1,5–5,0					☹	☹	☹	☹	☹								☹	☹	☹	☹			
	CNMG120416-RM5	1,6	0,30–0,55	2,0–5,0						☹	☹	☹	☹									☹	☹	☹			
	CNMG120408-RP7	0,8	0,25–0,50	0,8–5,0			☺	☺	☹																		
	CNMG120412-RP7	1,2	0,30–0,50	1,2–5,0			☺	☺	☹																		
	CNMG120416-RP7	1,6	0,35–0,50	1,5–5,0			☺	☺	☹																		
	CNMG160608-RP7	0,8	0,30–0,50	0,8–6,0			☺	☺	☹																		
	CNMG160612-RP7	1,2	0,35–0,60	1,2–6,0			☺	☺	☹																		
	CNMG160616-RP7	1,6	0,40–0,60	1,5–6,0			☺	☺	☹																		
	CNMG190612-RP7	1,2	0,35–0,60	1,2–7,0			☺	☺	☹																		
	CNMG190616-RP7	1,6	0,40–0,60	1,5–7,0			☺	☺	☹																		
	CNMG250924-RP7	2,4	0,45–1,00	3,0–9,0			☺	☺	☹																		

For dimensions, see the ISO 1832 designation key

HC = Coated carbide

Negative square SNMG Tiger-tec® Silver

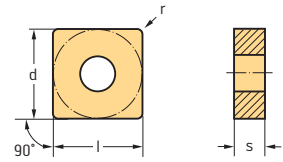

Indexable inserts

Designation	r mm	f mm	a _p mm	P				M			K			S		
				HC				HC			HC			HC		
				WPP05S	WPP10S	WPP20S	WPP30S	WMP20S	WSM10	WSM20	WSM30	WKK10S	WKK20S	WKP30S	WSM10	WSM20
 SNMG120408-RP7	0,8	0,25–0,50	0,8–5,0	☺	☺	☺	☺									
SNMG120412-RP7	1,2	0,30–0,50	1,2–5,0	☺	☺	☺	☺									
SNMG120416-RP7	1,6	0,35–0,50	1,5–5,0	☺	☺	☺	☺									
SNMG150608-RP7	0,8	0,30–0,50	0,8–6,0			☺	☺									
SNMG150612-RP7	1,2	0,35–0,60	1,2–6,0	☺	☺	☺	☺						☺			
SNMG150616-RP7	1,6	0,40–0,60	1,5–6,0	☺	☺	☺	☺						☺			
SNMG190612-RP7	1,2	0,35–0,60	1,2–7,0	☺	☺	☺	☺									
SNMG190616-RP7	1,6	0,40–0,60	1,5–7,0	☺	☺	☺	☺						☺			
SNMG190624-RP7	2,4	0,40–0,60	2,5–7,0			☺	☺						☺			
SNMG250924-RP7	2,4	0,55–1,00	3,0–10,0			☺							☺			

For dimensions, see the ISO 1832 designation key

HC = Coated carbide

New addition to the product range

Negative rhombic 35° VNMG Tiger-tec® Silver

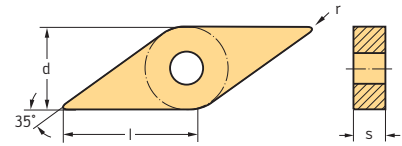

Indexable inserts

Designation	r mm	f mm	a _p mm	P				M			K			S		
				HC				HC			HC			HC		
				WPP05S	WPP10S	WPP20S	WPP30S	WMP20S	WSM10	WSM20	WSM30	WKK10S	WKK20S	WKP30S	WSM10	WSM20
 VNMG160404-MP5	0,4	0,10–0,18	0,5–2,0	☺	☺	☺	☺									
VNMG160408-MP5	0,8	0,18–0,35	0,6–4,0	☺	☺	☺	☺									
VNMG160412-MP5	1,2	0,20–0,40	0,8–4,0	☺	☺	☺	☺									
VNMG220408-MP5	0,8	0,18–0,35	0,6–4,0	☺	☺											



For dimensions, see the ISO 1832 designation key

HC = Coated carbide

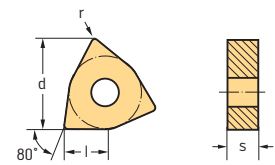
Negative Trigon 80° WNMG Tiger-tec® Silver



Indexable inserts

Designation	r mm	f mm	a _p mm	P				M					K			S								
				HC				HC					HC			HC								
				WPP05S	WPP10S	WPP20S	WPP30S	WMP20S	WMP20S	WSM10S	WSM20S	WSM30S	WSM10	WSM20	WSM30	WKK10S	WKK20S	WKP30S	WSM10S	WSM20S	WSM30S	WSM10	WSM20	WSM30
 WNMG060408-RM5	0,8	0,20–0,40	1,2–3,5					☺	☺	☺	☺													
WNMG080408-RM5	0,8	0,20–0,40	1,2–4,5					☺	☺	☺	☺						☺	☺	☺					
WNMG080412-RM5	1,2	0,25–0,50	1,5–4,5					☺	☺	☺	☺						☺	☺	☺					
 WNMG080408-RP7	0,8	0,16–0,45	1,0–5,0	☺	☺	☺																		
WNMG080412-RP7	1,2	0,20–0,45	1,5–5,0	☺	☺	☺																		
WNMG100608-RP7	0,8	0,25–0,45	1,0–8,0		☺	☺	☺																	
WNMG100612-RP7	1,2	0,25–0,60	1,5–8,0		☺	☺	☺																	
WNMG100616-RP7	1,6	0,35–0,70	2,0–8,0		☺	☺																		

For dimensions, see the ISO 1832 designation key

HC = Coated carbide

New addition to the product range

Positive rhombic 80°
CCMT
Tiger-tec® Silver

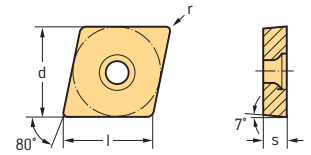

Indexable inserts

Designation	r mm	f mm	a _p mm	P					M					K		S				
				HC					HC					HC		HC				
				WPP01	WPP10S	WPP20S	WPP30S	WMP20S	WMP20S	WSM10S	WSM20S	WSM30S	WSM20	WSM30	WKK10S	WKK20S	WSM10S	WSM20S	WSM30S	WSM20
CCMT060204-PF	0,4	0,05–0,30	0,3–2,0	☺	☺	☺						☺	☺					☺	☺	
CCMT060208-PF	0,8	0,09–0,35	0,3–2,0	☺	☺	☺						☺	☺					☺	☺	
CCMT09T304-PF	0,4	0,07–0,30	0,3–3,0	☺	☺	☺						☺	☺					☺	☺	
CCMT09T308-PF	0,8	0,12–0,45	0,3–3,0	☺	☺	☺						☺	☺					☺	☺	
CCMT060202-FM4	0,2	0,04–0,12	0,1–1,0							☺	☺							☺	☺	
CCMT060204-FM4	0,4	0,05–0,16	0,1–1,5							☺	☺							☺	☺	
CCMT060208-FM4	0,8	0,08–0,20	0,1–1,5							☺	☺							☺	☺	
CCMT09T302-FM4	0,2	0,04–0,12	0,1–1,0							☺	☺							☺	☺	
CCMT09T304-FM4	0,4	0,05–0,16	0,1–1,5							☺	☺							☺	☺	
CCMT09T308-FM4	0,8	0,08–0,20	0,1–1,5							☺	☺							☺	☺	
CCMT120404-FM4	0,4	0,05–0,16	0,1–1,5							☺	☺							☺	☺	
CCMT120408-FM4	0,8	0,08–0,20	0,1–1,5							☺	☺							☺	☺	
CCMT09T304-PM	0,4	0,12–0,40	0,5–4,0		☺	☺														
CCMT09T308-PM	0,8	0,15–0,50	0,7–4,0		☺	☺														
CCMT09T312-PM	1,2	0,17–0,50	0,7–4,0			☺														
CCMT120408-PM	0,8	0,15–0,50	0,7–4,0			☺														
CCMT060204-RM4	0,4	0,12–0,25	0,4–2,5							☺	☺							☺	☺	
CCMT060208-RM4	0,8	0,16–0,30	0,6–2,5							☺	☺							☺	☺	
CCMT09T304-RM4	0,4	0,12–0,25	0,4–3,0							☺	☺							☺	☺	
CCMT09T308-RM4	0,8	0,16–0,35	0,6–4,0							☺	☺							☺	☺	
CCMT120404-RM4	0,4	0,12–0,25	0,4–3,0							☺	☺							☺	☺	
CCMT120408-RM4	0,8	0,16–0,40	0,6–5,0							☺	☺							☺	☺	
CCMT120412-RM4	1,2	0,20–0,50	0,8–5,0							☺	☺							☺	☺	



For dimensions, see the ISO 1832 designation key

HC = Coated carbide

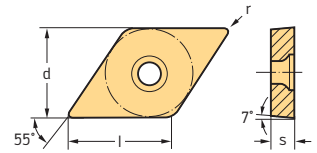
Positive rhombic 55°
DCMT
Tiger-tec® Silver



Indexable inserts

Designation	r mm	f mm	a _p mm	P					M					K		S					
				HC					HC					HC		HC					
				WPP01	WPP10S	WPP20S	WPP30S	WMP20S	WMP20S	WSM10S	WSM20S	WSM30S	WSM20	WSM30	WKK10S	WKK20S	WSM10S	WSM20S	WSM30S	WSM20	WSM30
 DCMT070204-PF	0,4	0,05–0,25	0,3–2,0	☺	☺	☹						☹	☹						☹	☹	
DCMT070208-PF	0,8	0,05–0,25	0,3–2,0																	☹	☹
DCMT11T304-PF	0,4	0,07–0,30	0,3–3,0	☺	☺	☺						☹	☹						☹	☹	
DCMT11T308-PF	0,8	0,12–0,40	0,3–3,0	☺	☺	☺						☹	☹						☹	☹	
 DCMT070202-FM4	0,2	0,04–0,12	0,1–1,0													☹	☹	☹			
DCMT070204-FM4	0,4	0,05–0,16	0,1–1,5						☹	☹	☹	☹				☹	☹	☹			
DCMT070208-FM4	0,8	0,08–0,20	0,1–2,5						☹	☹	☹					☹	☹	☹			
DCMT11T302-FM4	0,2	0,04–0,12	0,1–1,0						☹	☹	☹					☹	☹	☹			
DCMT11T304-FM4	0,4	0,05–0,16	0,1–1,5						☹	☹	☹					☹	☹	☹			
DCMT11T308-FM4	0,8	0,08–0,20	0,1–1,5						☹	☹	☹					☹	☹	☹			
 DCMT070204-RM4	0,4	0,12–0,20	0,4–2,0						☹	☹	☹					☹	☹	☹			
DCMT070208-RM4	0,8	0,16–0,25	0,6–2,0						☹	☹	☹					☹	☹	☹			
DCMT11T304-RM4	0,4	0,12–0,25	0,4–3,0						☹	☹	☹					☹	☹	☹			
DCMT11T308-RM4	0,8	0,16–0,30	0,6–4,0						☹	☹	☹					☹	☹	☹			
DCMT11T312-RM4	1,2	0,20–0,35	0,8–4,0						☹	☹	☹					☹	☹	☹			

For dimensions, see the ISO 1832 designation key

HC = Coated carbide

**Positive round
RCMT
Tiger-tec® Silver**

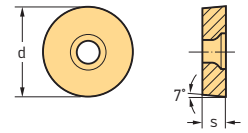

Indexable inserts

Designation	d mm	f mm	a _p mm	P				M			K		S		
				HC				HC			HC		HC		
				WPP10S	WPP20S	WPP30S	WMP20S	WMP20S	WSM10S	WSM20S	WSM30S	WKK10S	WKK20S	WSM10S	WSM20S
	RCMT0602M0-FM4	6	0,07–0,30	0,6–2,5											
	RCMT0803M0-FM4	8	0,08–0,30	0,8–3,0											
	RCMT10T3M0-FM4	10	0,10–0,35	1,0–4,0											
	RCMT1204M0-FM4	12	0,12–0,40	1,2–5,0											
	RCMT0602M0-RM4	6	0,08–0,50	0,6–2,5											
	RCMT060300-RM4	6,35	0,08–0,50	0,6–2,5											
	RCMT0803M0-RM4	8	0,10–0,60	0,8–3,0											
	RCMT09T300-RM4	9,525	0,08–0,50	0,6–2,5											
	RCMT10T3M0-RM4	10	0,12–0,80	1,0–4,0											
	RCMT1204M0-RM4	12	0,12–1,00	1,2–5,0											
	RCMT120400-RM4	12,7	0,12–1,00	1,2–5,0											
	RCMT1606M0-RM4	16	0,15–1,20	1,6–7,0											
	RCMT0602M0-RK4	6	0,08–0,50	0,6–2,5											
	RCMT0803M0-RK4	8	0,10–0,60	0,8–3,0											
	RCMT10T3M0-RK4	10	0,12–0,80	1,0–4,0											
	RCMT1204M0-RK4	12	0,12–1,00	1,2–5,0											
	RCMT1605M0-RK4	16	0,15–1,20	1,6–7,0											
	RCMT1606M0-RK4	16	0,15–1,20	1,6–7,0											

For dimensions, see the ISO 1832 designation key

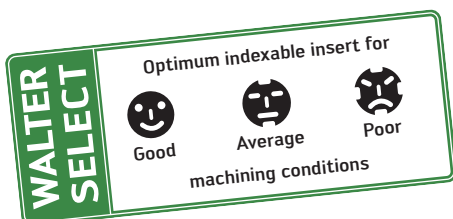

HC = Coated carbide

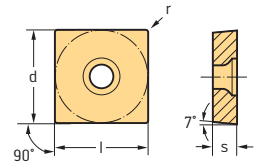

Positive square
SCMT
Tiger-tec® Silver



Indexable inserts

Designation	r mm	f mm	a _p mm	P			M			K		S									
				HC			HC			HC		HC									
				WPP10S	WPP20S	WPP30S	WMP20S	WSM10S	WSM20S	WSM30S	WKK10S	WKK20S	WSM10S	WSM20S	WSM30S						
 SCMT09T304-FM4 SCMT09T308-FM4 SCMT120408-FM4	0,4	0,05–0,15	0,1–1,5																		
	0,8	0,05–0,18	0,1–1,8																		
	0,8	0,05–0,18	0,1–1,8																		
 SCMT09T304-RM4 SCMT09T308-RM4 SCMT120404-RM4 SCMT120408-RM4 SCMT120412-RM4	0,4	0,12–0,25	0,4–3,0																		
	0,8	0,16–0,35	0,6–4,0																		
	0,4	0,12–0,25	0,4–3,0																		
	0,8	0,16–0,40	0,6–5,0																		
	1,2	0,20–0,50	0,8–5,0																		

For dimensions, see the ISO 1832 designation key

HC = Coated carbide

New addition to the product range

**Positive triangular 60°
TCMT
Tiger-tec® Silver**

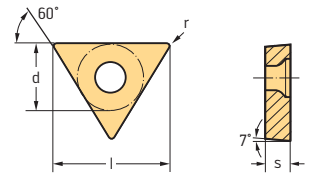

Indexable inserts

Designation	r mm	f mm	a _p mm	P				M				K		S		
				HC				HC				HC		HC		
				WPP10S	WPP20S	WPP30S	WMP20S	WMP20S	WSM10S	WSM20S	WSM30S	WSM21	WKK10S	WKK20S	WSM10S	WSM20S
	TCMT06T102-FM4	0,2	0,02-0,10	0,1-1,0												
	TCMT06T104-FM4	0,4	0,04-0,17	0,1-1,0												
	TCMT090202-FM4	0,2	0,04-0,12	0,1-1,0												
	TCMT090204-FM4	0,4	0,05-0,16	0,1-1,5												
	TCMT090208-FM4	0,8	0,08-0,20	0,1-1,5												
	TCMT110202-FM4	0,2	0,04-0,12	0,1-1,0												
	TCMT110204-FM4	0,4	0,05-0,16	0,1-1,5												
	TCMT110208-FM4	0,8	0,08-0,20	0,1-1,5												
	TCMT16T302-FM4	0,2	0,04-0,12	0,1-1,0												
	TCMT16T304-FM4	0,4	0,05-0,16	0,1-1,5												
	TCMT16T308-FM4	0,8	0,08-0,20	0,1-1,5												
	TCMT090204-RM4	0,4	0,12-0,25	0,4-3,0												
	TCMT090208-RM4	0,8	0,16-0,30	0,6-3,0												
	TCMT110204-RM4	0,4	0,12-0,25	0,4-3,0												
	TCMT110208-RM4	0,8	0,16-0,30	0,6-3,0												
	TCMT16T304-RM4	0,4	0,12-0,25	0,4-3,0												
	TCMT16T308-RM4	0,8	0,16-0,30	0,6-4,0												
	TCMT16T312-RM4	1,2	0,20-0,40	0,8-4,0												

For dimensions, see the ISO 1832 designation key

HC = Coated carbide

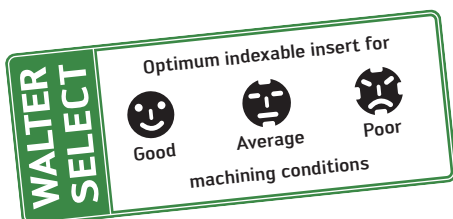

Positive rhombic 35° VCMT / VBMT Tiger-tec® Silver

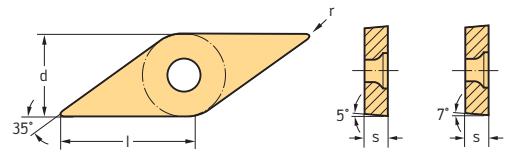

Indexable inserts

Designation	r mm	f mm	a _p mm	P		M				K		S		
				HC		HC				HC		HC		
				WPP10S	WPP20S	WPP30S	WMP20S	WMP20S	WSM10S	WSM20S	WSM30S	WKK10S	WKK20S	WSM10S
VCMT110302-FM4	0,2	0,04–0,12	0,1–1,0			☺	☺	☺	☺			☺	☺	☺
VCMT110304-FM4	0,4	0,05–0,16	0,1–1,5			☺	☺	☺	☺			☺	☺	☺
VCMT160402-FM4	0,2	0,04–0,12	0,1–1,0			☺	☺	☺	☺			☺	☺	☺
VCMT160404-FM4	0,4	0,05–0,16	0,1–1,5			☺	☺	☺	☺			☺	☺	☺
VCMT160408-FM4	0,8	0,08–0,20	0,1–1,5			☺	☺	☺	☺			☺	☺	☺
VBMT110304-FP6	0,4	0,06–0,18	0,3–2,0	☹	☹									
VBMT110308-FP6	0,8	0,10–0,20	0,5–2,0	☹	☹									
VBMT160404-FP6	0,4	0,08–0,20	0,3–2,0	☹	☹									
VBMT160406-FP6	0,6	0,10–0,25	0,4–2,0	☹	☹									
VBMT160408-FP6	0,8	0,10–0,25	0,5–2,0	☹	☹									
VBMT160412-FP6	1,2	0,12–0,30	0,6–2,0	☹	☹									
VBMT110304-FK6	0,4	0,06–0,18	0,3–2,0							☹	☹			
VBMT110308-FK6	0,8	0,10–0,20	0,5–2,0							☹	☹			
VBMT160404-FK6	0,4	0,08–0,20	0,3–2,0							☹	☹			
VBMT160406-FK6	0,6	0,10–0,25	0,4–2,0							☹	☹			
VBMT160408-FK6	0,8	0,10–0,25	0,5–2,0							☹	☹			
VBMT160412-FK6	1,2	0,12–0,30	0,6–2,0							☹	☹			
VBMT110304-MM4	0,4	0,08–0,20	0,4–1,5			☺	☺						☺	
VBMT110308-MM4	0,8	0,12–0,25	0,5–1,5					☺	☺				☺	☺
VBMT160404-MM4	0,4	0,08–0,20	0,4–2,0			☺	☺	☺	☺				☺	☺
VBMT160408-MM4	0,8	0,12–0,30	0,5–2,0			☺	☺	☺	☺				☺	☺
VBMT160412-MM4	1,2	0,12–0,32	0,5–2,0					☺	☺				☺	☺
VCMT110304-RM4	0,4	0,12–0,20	0,4–2,5			☹	☹	☹	☹				☹	☹
VCMT110308-RM4	0,8	0,16–0,25	0,6–3,0										☹	☹
VCMT160404-RM4	0,4	0,12–0,25	0,4–2,5			☺	☺	☺	☺				☺	☺
VCMT160408-RM4	0,8	0,16–0,30	0,6–3,0			☺	☺	☺	☺				☺	☺
VCMT160412-RM4	1,2	0,20–0,35	0,8–4,0					☹	☹				☹	☹



For dimensions, see the ISO 1832 designation key

HC = Coated carbide

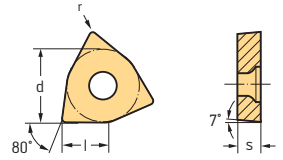
**Positive Trigon 80°
WCMT
Tiger-tec® Silver**



Indexable inserts

Designation	r mm	f mm	a _p mm	P				M				K		S			
				HC				HC				HC		HC			
				WPP10S	WPP20S	WPP30S	WMP20S	WMP20S	WSM10S	WSM20S	WSM30S	WSM20	WKK10S	WKK20S	WSM10S	WSM20S	WSM30S
 Wiper	WCMT040204-PF	0,4	0,05–0,30	0,3–1,5	☹	☹										☹	
	WCMT06T304-PF	0,4	0,07–0,30	0,3–2,0	☹												☹
	WCMT06T308-PF	0,8	0,07–0,35	0,3–2,0	☹												☹
	WCMT040202-FM4	0,2	0,04–0,12	0,1–1,0						☹	☹					☹	☹
	WCMT040204-FM4	0,4	0,05–0,16	0,1–1,5						☹	☹					☹	☹
	WCMT06T304-FM4	0,4	0,05–0,16	0,1–1,5						☹	☹					☹	☹
	WCMT06T308-FM4	0,8	0,08–0,20	0,1–1,5						☹	☹					☹	☹
	WCMT030202-RM4	0,2	0,08–0,12	0,2–1,5						☹						☹	
	WCMT040202-RM4	0,2	0,08–0,12	0,4–2,0						☹	☹					☹	☹
	WCMT040204-RM4	0,4	0,12–0,25	0,4–2,5						☹	☹					☹	☹
	WCMT06T304-RM4	0,4	0,12–0,25	0,4–3,0						☹	☹					☹	☹
	WCMT06T308-RM4	0,8	0,16–0,35	0,6–4,0						☹	☹					☹	☹
	WCMT080408-RM4	0,8	0,16–0,40	0,6–4,0						☹	☹					☹	☹
	WCMT080412-RM4	1,2	0,20–0,55	0,8–5,0						☹	☹					☹	☹

For dimensions, see the ISO 1832 designation key

HC = Coated carbide

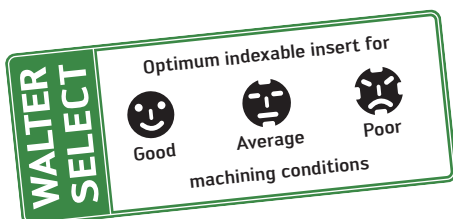

Grooving and copy turning

GX cutting inserts

Tiger-tec® Silver

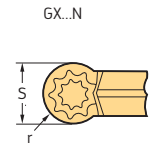
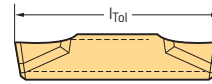

Cutting inserts

Designation	s mm	r mm	l mm	f mm	a _p mm	S _{Tol} mm	l _{Tol} mm	P				M				K		S			
								HC				HC				HC		HC			
								WKP23S	WSM13S	WSM23S	WSM33S	WSM43S	WKP23S	WSM13S	WSM23S	WSM33S	WSM43S	WKP23S	WSM13S	WSM23S	WSM33S
GX16-1E200N10-RF8	2	1	16	0,08–0,25	0,1–1,0	±0,02	±0,02	☺	☺	☺		☺	☺			☺	☺				
GX16-2E300N15-RF8	3	1,5	16	0,10–0,30	0,1–1,5	±0,02	±0,02	☺	☺	☺		☺	☺			☺	☺				
GX24-2E300N15-RF8	3	1,5	24	0,10–0,30	0,1–1,5	±0,02	±0,02	☺	☺			☺	☺			☺	☺				
GX24-2E318N16-RF8	3,18	1,59	24	0,10–0,30	0,1–1,5	±0,02	±0,02		☺				☺				☺	☺			
GX24-3E400N20-RF8	4	2	24	0,12–0,45	0,1–2,0	±0,02	±0,02	☺	☺			☺	☺			☺	☺				
GX24-3E475N24-RF8	4,75	2,38	24	0,13–0,48	0,1–2,3	±0,02	±0,02		☺				☺				☺	☺			
GX24-3E500N25-RF8	5	2,5	24	0,15–0,50	0,1–2,5	±0,02	±0,02	☺	☺			☺	☺			☺	☺				
GX24-4E600N30-RF8	6	3	24	0,15–0,55	0,1–3,0	±0,02	±0,02	☺	☺			☺	☺			☺	☺				
GX24-4E635N32-RF8	6,35	3,18	24	0,15–0,55	0,1–3,0	±0,02	±0,02		☺				☺				☺	☺			
GX30-5E800N40-RF8	8	4	30	0,18–0,60	0,2–4,0	±0,02	±0,02	☺	☺			☺	☺			☺	☺				

l_{Tol} = Repeat accuracy after changing indexable inserts
 Radius tolerance r_{Tol} = ± 0.05 mm

HC = Coated carbide

☺ ☹ ☹ ☹ New addition to the product range

Grooving and parting off SX cutting inserts Tiger-tec® Silver

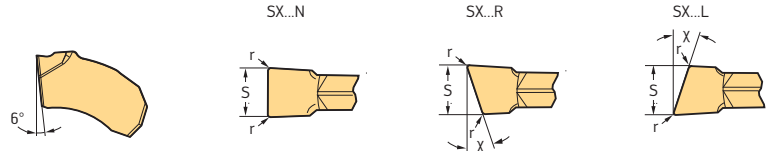

Cutting inserts

Designation	s mm	r mm	κ	f mm	S _{Tol} mm	l _{Tol} mm	P		M		K	N	S		
							HC		HC		HC	HW	HC		
							WKP23S	WSM23S	WSM33S	WSM43S	WSM23S	WSM33S	WSM43S	WKP23S	WK1
SX-1E150N01-CF5	1,5	0,15		0,03-0,10	±0,05	±0,01		⊗	⊗	⊗				⊗	⊗
SX-1E150R/L6-CF5	1,5	0,15	6°	0,03-0,08	±0,05	±0,01		⊗	⊗	⊗				⊗	⊗
SX-1E150R/L7-CF5	1,5	0	7°	0,03-0,08	±0,05	±0,01		⊗	⊗	⊗				⊗	⊗
SX-1E150R/L15-CF5	1,5	0	15°	0,03-0,08	±0,05	±0,01		⊗	⊗	⊗				⊗	⊗
SX-2E200N02-CF5	2	0,2		0,04-0,12	±0,05	±0,01		⊗	⊗	⊗		⊗		⊗	⊗
SX-2E200R/L6-CF5	2	0,2	6°	0,04-0,10	±0,05	±0,01		⊗	⊗	⊗				⊗	⊗
SX-2E200R/L7-CF5	2	0	7°	0,04-0,10	±0,05	±0,01		⊗	⊗	⊗				⊗	⊗
SX-2E200R/L15-CF5	2	0	15°	0,03-0,08	±0,05	±0,01		⊗	⊗	⊗				⊗	⊗
SX-3E300N02-CF5	3	0,2		0,08-0,20	±0,05	±0,01		⊗	⊗	⊗		⊗		⊗	⊗
SX-3E300R/L6-CF5	3	0,2	6°	0,08-0,17	±0,05	±0,01		⊗	⊗	⊗				⊗	⊗
SX-3E300R/L7-CF5	3	0	7°	0,08-0,17	±0,05	±0,01		⊗	⊗	⊗				⊗	⊗
SX-3E300R/L15-CF5	3	0	15°	0,05-0,15	±0,05	±0,01		⊗	⊗	⊗				⊗	⊗
SX-3E310N03-CF5	3,1	0,3		0,08-0,20	±0,05	±0,01		⊗	⊗	⊗				⊗	⊗
SX-4E400N02-CF5	4	0,2		0,10-0,22	±0,05	±0,01		⊗	⊗	⊗				⊗	⊗
SX-4E400R/L6-CF5	4	0,2	6°	0,10-0,20	±0,05	±0,01		⊗	⊗	⊗				⊗	⊗
SX-5E500N04-CF5	5	0,4		0,10-0,25	±0,05	±0,01		⊗	⊗	⊗				⊗	⊗
SX-5E500R/L6-CF5	5	0,4	6°	0,10-0,20	±0,05	±0,01		⊗	⊗	⊗				⊗	⊗
SX-6E600N04-CF5	6	0,4		0,10-0,30	±0,05	±0,01		⊗	⊗	⊗				⊗	⊗
SX-1E150N01-CE4	1,5	0,15		0,03-0,12	±0,05	±0,01		⊗	⊗	⊗				⊗	⊗
SX-1E150R/L6-CE4	1,5	0,15	6°	0,03-0,08	±0,05	±0,01		⊗	⊗	⊗				⊗	⊗
SX-2E200N02-CE4	2	0,2		0,06-0,15	±0,05	±0,01	⊗	⊗	⊗	⊗		⊗		⊗	⊗
SX-2E200R/L6-CE4	2	0,2	6°	0,06-0,10	±0,05	±0,01		⊗	⊗	⊗				⊗	⊗
SX-2E260N03-CE4	2,6	0,3		0,06-0,18	±0,05	±0,01	⊗	⊗	⊗	⊗			⊗	⊗	⊗
SX-3E300N02-CE4	3	0,2		0,09-0,30	±0,05	±0,01	⊗	⊗	⊗	⊗		⊗		⊗	⊗
SX-3E300R/L6-CE4	3	0,2	6°	0,09-0,20	±0,05	±0,01	⊗	⊗	⊗	⊗				⊗	⊗
SX-3E310N03-CE4	3,1	0,3		0,09-0,30	±0,05	±0,01	⊗	⊗	⊗	⊗				⊗	⊗
SX-4E400N02-CE4	4	0,2		0,10-0,32	±0,05	±0,01	⊗	⊗	⊗	⊗			⊗	⊗	⊗
SX-4E400R/L6-CE4	4	0,2	6°	0,10-0,22	±0,05	±0,01	⊗	⊗	⊗	⊗				⊗	⊗
SX-4E410N03-CE4	4,1	0,3		0,10-0,32	±0,05	±0,01	⊗	⊗	⊗	⊗				⊗	⊗
SX-4E480N03-CE4	4,8	0,3		0,12-0,35	±0,05	±0,01	⊗	⊗	⊗	⊗				⊗	⊗
SX-5E500N04-CE4	5	0,4		0,12-0,35	±0,05	±0,01	⊗	⊗	⊗	⊗			⊗	⊗	⊗
SX-5E500R/L6-CE4	5	0,4	6°	0,12-0,25	±0,05	±0,01		⊗	⊗	⊗				⊗	⊗
SX-6E600N04-CE4	6	0,4		0,12-0,40	±0,05	±0,01	⊗	⊗	⊗	⊗				⊗	⊗
SX-6E600R/L6-CE4	6	0,4	6°	0,12-0,30	±0,05	±0,01		⊗	⊗	⊗				⊗	⊗
SX-8E800N08-CE4	8	0,8		0,20-0,55	±0,05	±0,01	⊗	⊗	⊗	⊗				⊗	⊗
SX-10E1000N08-CE4	10	0,8		0,25-0,60	±0,05	±0,01	⊗	⊗	⊗	⊗				⊗	⊗

l_{Tol} = Repeat accuracy after changing indexable inserts
Radius tolerance r_{Tol} = ± 0.05 mm

HC = Coated carbide
HW = Uncoated carbide

Shank type tool – 0°/90° universal G1511...-P

Walter Cut

- Screw clamping
- Precision cooling

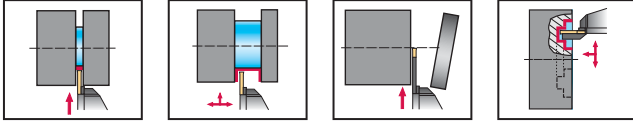

Tool	Designation	s mm	T _{max} mm	h = h ₁ mm	b mm	f ₁ mm	l ₁ mm	l ₄ mm	Type
	★ G1511.1616R/L-T4GX16-P	2-6	4	16	16	13,85	120	31,5	GX16- ..
	★ G1511.1616R/L-T6GX24-P	3-6	6	16	16	13,85	120	33	GX24- ..
	★ G1511.2020R/L-T4GX16-P	2-6	4	20	20	17,85	120	31,1	GX16- ..
	★ G1511.2525R/L-T4GX16-P		4	25	25	22,85	130	31,2	
	★ G1511.2020R/L-T6GX24-P	3-6	6	20	20	17,85	120	33,5	GX24- ..
	★ G1511.2525R/L-T6GX24-P		6	25	25	22,85	130	32,9	

$$f = f_1 + s/2$$

Connection set for internal coolant supply with G1/8" thread

The recommended maximum coolant pressure is 150 bar (2175 psi).

Ordering example, right-hand tool: G1511.1616R-T4GX16-P/ordering example, left-hand tool: G1511.1616L-T4GX16-P

Bodies and assembly parts are included in the scope of delivery.

- ★ New addition to the product range

Assembly parts	Type	GX16- ..	GX24- ..
	Clamping screw for grooving insert Tightening torque	FS2118 (Torx 20 IP) 5.0 Nm	FS2118 (Torx 20 IP) 5.0 Nm
	G 1/8" threaded plug	FS2258 (SW 5)	FS2258 (SW 5)
	M6 threaded plug	FS2288 (SW 3)	FS2288 (SW 3)
	Torx key	FS1464 (Torx 20 IP)	FS1464 (Torx 20 IP)

Shank type tool – 0°/90° universal G1511...-P inch

Walter Cut

- Screw clamping
- Precision cooling

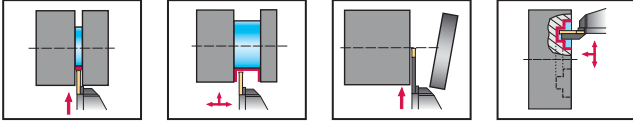

Tool		s	T _{max}	h = h ₁	b	f ₁	l ₁	l ₄	Type
Designation		mm	mm	mm	mm	mm	mm	mm	
	★ G1511.16R/L-T4GX16-P	2-6	4	25,4	25,4	23,25	150	31	GX16- ..
	★ G1511.16R/L-T6GX24-P	3-6	6	25,4	25,4	23,25	150	33	GX24- ..

f = f₁ + s/2
 Connection set for internal coolant supply with G1/8" thread
 The recommended maximum coolant pressure is 150 bar (2175 psi).
 Ordering example, right-hand tool: G1511.16R-T4GX16-P/ordering example, left-hand tool: G1511.16L-T4GX16-P
 Bodies and assembly parts are included in the scope of delivery.

★ New addition to the product range

Assembly parts		GX16- ..	GX24- ..
	Clamping screw for grooving insert Tightening torque	FS2118 (Torx 20 IP) 5.0 Nm	FS2118 (Torx 20 IP) 5.0 Nm
	G 1/8" threaded plug	FS2258 (SW 5)	FS2258 (SW 5)
	Torx key	FS1464 (Torx 20 IP)	FS1464 (Torx 20 IP)

Cutting data for turning inserts – Negative basic shape

Carbide grades

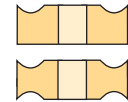

Material group	Overview of the main material groups and code letters		Brinell hardness HB	Tensile strength R_m N/mm ²	Machining group ¹		Cutting material grades				
							Starting values for cutting speed v_c [m/min]				
							HC				
							WMP20S				
							f [mm/U]				
							0,10	0,40	0,60		
P	Non-alloyed steel	C ≤ 0.25%	Annealed	125	430	P1	●●	●	340	230	190
		C > 0.25... ≤ 0.55%	Annealed	190	640	P2	●●	●	290	190	150
		C > 0.25... ≤ 0.55%	Heat-treated	210	710	P3	●●	●	210	170	130
		C > 0.55%	Annealed	190	640	P4	●●	●	270	170	130
		C > 0.55%	Heat-treated	300	1010	P5	●●	●	160	110	90
		Free cutting steel (short-chipping)	Annealed	220	750	P6	●●	●			
	Low-alloyed steel	Annealed		175	590	P7	●●	●	240	170	150
		Heat-treated		285	960	P8	●●	●	160	100	70
		Heat-treated		380	1280	P9	●●	●	120	80	50
		Heat-treated		430	1480	P10	●●	●			
High-alloyed steel and high-alloyed tool steel	Annealed		200	680	P11	●●	●	240	170	100	
	Hardened and tempered		300	1010	P12	●●	●	100	70	60	
	Hardened and tempered		380	1280	P13	●●	●				
Stainless steel	Ferritic/martensitic, annealed		200	680	P14	●●	●	280	240	200	
	Martensitic, heat-treated		330	1110	P15	●●	●	190	150	130	
M	Stainless steel	Austenitic, quench hardened		200	680	M1	●●	●	250	190	120
		Austenitic, precipitation hardened (PH)		300	1010	M2	●●	●	150	130	
		Austenitic/ferritic, duplex		230	780	M3	●●	●	160	140	100
K	Malleable cast iron	Ferritic		200	400	K1	●●	●			
		Pearlitic		260	700	K2	●●	●			
	Grey cast iron	Low tensile strength		180	200	K3	●●	●			
		High tensile strength/austenitic		245	350	K4	●●	●			
	Cast iron with spheroidal graphite	Ferritic		155	400	K5	●●	●			
Pearlitic			265	700	K6	●●	●				
	GGV (CGI)		230	400	K7	●●	●				
N	Aluminium wrought alloys	Cannot be hardened		30	–	N1					
		Hardenable, hardened		100	340	N2					
	Cast aluminium alloys	≤ 12% Si, cannot be hardened		75	260	N3					
		≤ 12% Si, hardenable, hardened		90	310	N4					
		> 12% Si, cannot be hardened		130	450	N5					
	Magnesium alloys ³		70	250	N6						
	Copper and copper alloys (bronze/brass)	Non-alloyed, electrolytic copper		100	340	N7					
Brass, bronze, red brass			90	310	N8						
Cu-alloys, short-chipping			110	380	N9						
High-strength, Ampco			300	1010	N10						
S	Heat-resistant alloys	Fe-based	Annealed	200	680	S1	●●	●	90	60	
			Hardened	280	940	S2	●●	●	70	50	
		Ni or Co base	Annealed	250	840	S3	●●	●	70	50	
			Hardened	350	1180	S4	●●	●	60	60	
		Cast	320	1080	S5	●●	●	50	30		
	Titanium alloys	Pure titanium		200	680	S6					
		α and β alloys, hardened		375	1260	S7	●●	●	70	45	40
		β alloys		410	1400	S8	●●	●	40	30	25
Tungsten alloys		300	1010	S9	●●						
Molybdenum alloys		300	1010	S10	●●						
H	Hardened steel	Hardened and tempered	50 HRC	–	H1						
		Hardened and tempered	55 HRC	–	H2						
		Hardened and tempered	60 HRC	–	H3						
	Hardened cast iron	Hardened and tempered	55 HRC	–	H4						
O	Thermoplastics	Without abrasive fillers			O1						
	Thermosetting plastics	Without abrasive fillers			O2						
	Plastic, glass-fibre-reinforced	GFRP			O3						
	Plastic, carbon-fibre-reinforced	CFRP			O4						
	Plastic, aramid-fibre-reinforced	AFRP			O5						
	Graphite (technical)		80 Shore		O6						

- Recommended application (the specified cutting data is regarded as starting values for the recommended application)
- Possible application, reduce cutting data by 30–50% (increase by approx. 70–80% for ISO M)

Note: If dry machining is possible, the tool life is reduced by 20–30% on average

¹ The classification of the machining groups can be found in the Walter General Catalogue 2012 from page H 8 onwards.

³ Water-miscible coolants must not be used when machining magnesium alloys.

DC170 Supreme – visibly different, completely reliable.

NEW TO THE RANGE

NEW ADDITIONS TO THE PRODUCT RANGE

- 25 × D_c
- 30 × D_c

Existing range :

- 3 × D_c (DIN 6537 short)
- 5 × D_c (DIN 6537 long)
- 8 × D_c
- 12 × D_c
- 16 × D_c
- 20 × D_c

THE APPLICATION

- ISO P, ISO K
- Can be used with emulsion and oil
- For interrupted cuts and inclined exits
- Areas of use: General mechanical engineering, tool and mould making, automotive and energy industries

THE TOOL

- Solid carbide high-performance drill with through coolant
- Grade: WJ30EJ, K30F, Tinal/AlCrN multilayer
- Diameter range 3–20 mm

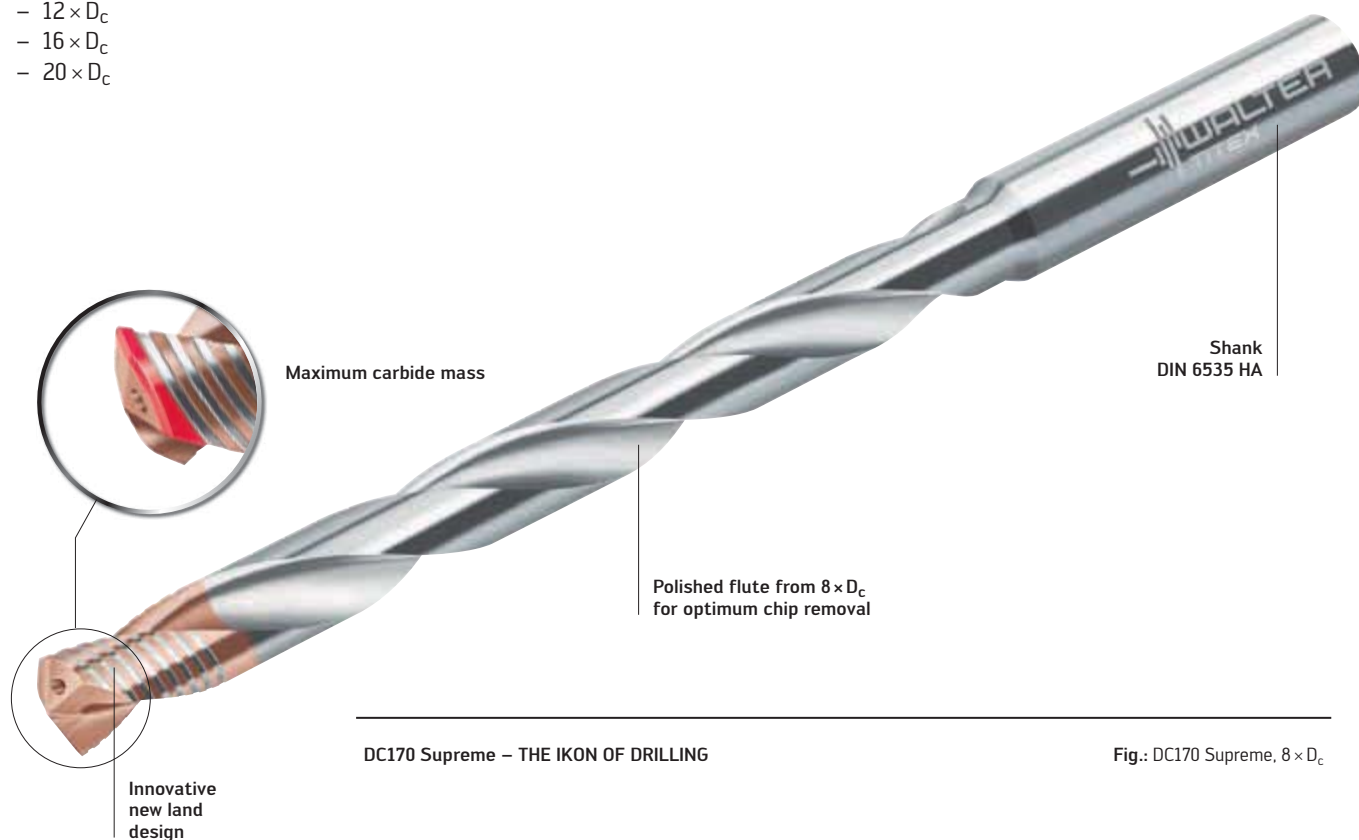

DC170 Supreme – THE IKON OF DRILLING

Fig.: DC170 Supreme, 8 × D_c

Ordering information
from page 43.



Watch product animation:
Scan this QR code or go directly
to <http://goo.gl/sdD3ri>



Watch product animation:
Scan this QR code or go directly
to <http://goo.gl/6JwZ8Y>

BENEFITS FOR YOU

- Increased productivity thanks to 50% longer tool life with 35% higher workpiece values (in comparison to conventional solid carbide drills)
- Better component quality due to the drill having constant guidance of its circumference
- Reduced manufacturing costs thanks to optimum tool use (the number of grooves indicates the service stage of the drill)
- Maximum carbide mass for maximum process reliability
- 360° coolant coverage for maximum cooling effect

DC150 Perform – flexible in use and wear-resistant.

NEW TO THE RANGE

NEW ADDITION TO THE PRODUCT RANGE

- 12 × D_c with internal coolant

Existing range:

- 3 × D_c (DIN 6537 short) without internal coolant
- 5 × D_c (DIN 6537 long) with internal coolant
- 8 × D_c with internal coolant

THE APPLICATION

- ISO P, M, K, N, S, H, O
- Can be used with oil and emulsion
- Areas of use: General mechanical engineering, tool and mould making, energy and automotive industries

THE TOOL

- Solid carbide twist drill
- Grades: WJ30RE and WJ30TA; K30F-TiAlN
- 140° point angle
- Diameter range 3–20 mm

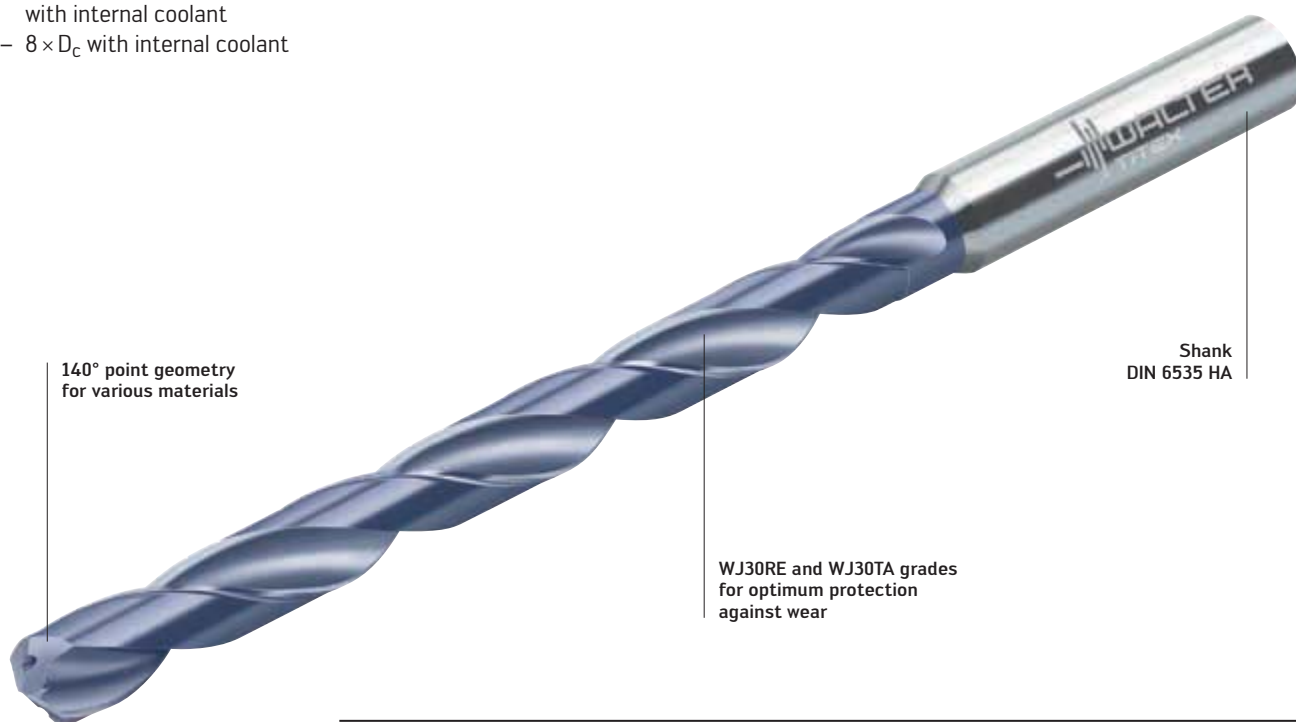

140° point geometry for various materials

WJ30RE and WJ30TA grades for optimum protection against wear

Shank
DIN 6535 HA

DC150 Perform

Fig.: DC150 Perform, 8 × D_c

BENEFITS FOR YOU

- Cost-efficient machining of small and medium batch sizes
- Universal in its use on all materials
- Shank variants for all adaptors typically used in drilling such as: Whistle Notch toolholders, hydraulic expansion chucks, collet chucks, shrink-fit chucks and power clamping chucks

Ordering information from page 40.

X-treme Inox – extremely high performance in stainless steel.

NEW TO THE RANGE

NEW ADDITION TO THE PRODUCT RANGE

- $8 \times D_c$

Existing range:

- $3 \times D_c$ (DIN 6537 short)
- $5 \times D_c$ (DIN 6537 long)

THE APPLICATION

- ISO M
- Can be used with emulsion and oil
- Areas of use: General mechanical engineering, automotive, aerospace, medical and food industries

THE TOOL

- Solid carbide high-performance drill with through coolant
- TTP coating
- Diameter range 3–20 mm

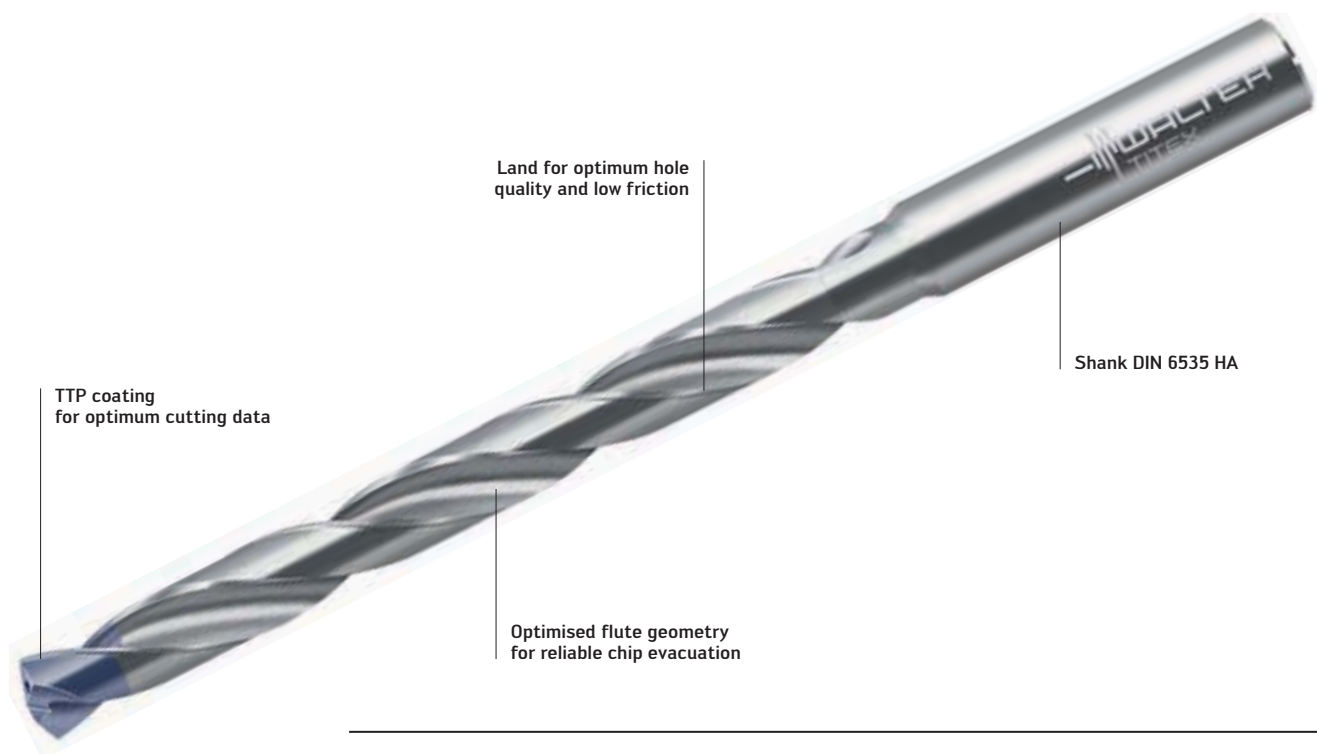

X-treme Inox

Fig.: A6493TTP, $8 \times D_c$

BENEFITS FOR YOU

- Reduced cutting forces thanks to new type of geometry
- Significant increase in productivity over universal drilling tools
- Low burr formation on entry and exit
- Excellent surface quality on the component
- Stable main cutting edges for maximum process reliability

DC173 – specialist tool for crankshaft machining with MMS.

SPECIAL TOOL

THE APPLICATION

- For all ISO P and ISO K materials
- For MMS and wet machining with oil and emulsion
- Specialist tool for oil holes in crankshafts and deep hole drilling for injector nozzles
- Areas of use: The automotive industry, general mechanical engineering, tool manufacturing and mould making

Dimensions:

- $12-35 \times D_c$

THE TOOL

- Solid carbide drill with through coolant
- 140° point angle
- Diameter range 3–12 mm

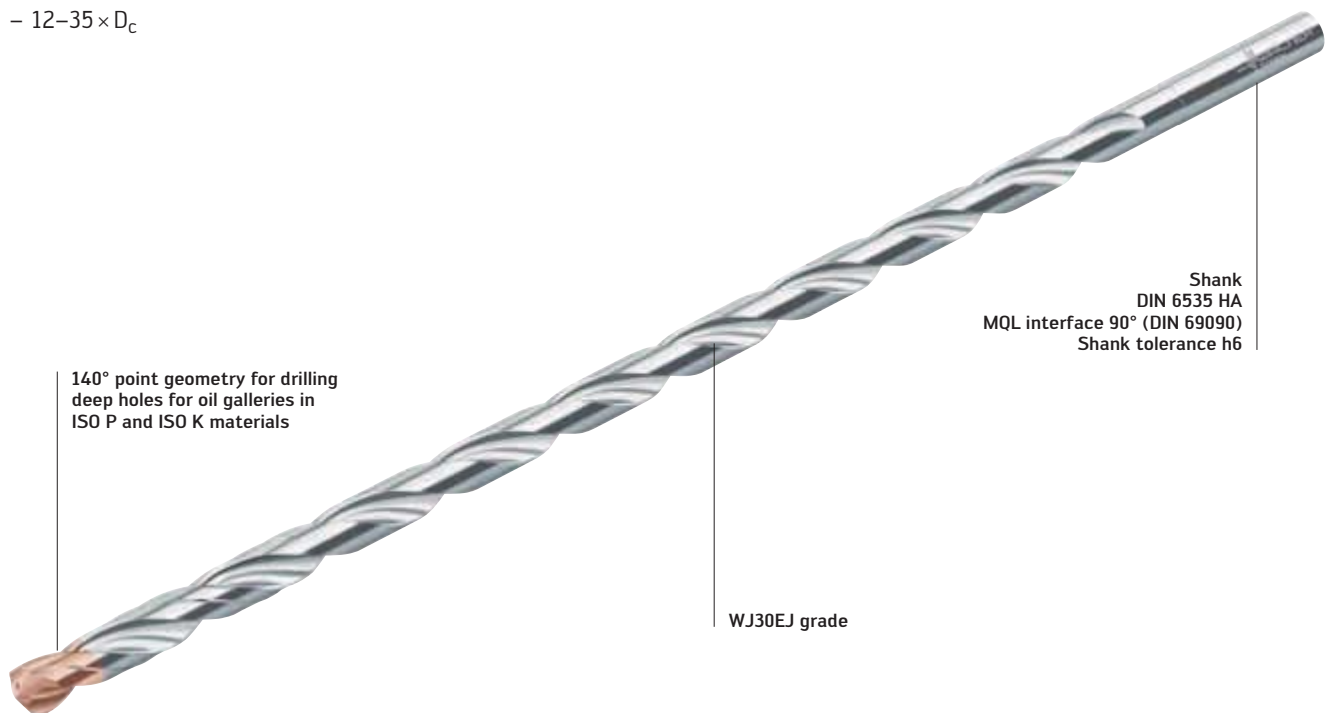

DC173

Fig.: DC173, $20 \times D_c$

BENEFITS FOR YOU

- Universal use for common materials in the automotive field
- Optimised for MQL and wet machining
- Improved cost per part (CPP) and process reliability
- World-wide Walter Reconditioning Service:
Reconditioning the tools can increase their cost efficiency by up to 3 times

Additional information regarding **special tools** is available from your local contact partner.

The new grade for cast iron: P6005-WKK45C – now with a larger diameter range.

NEW TO THE RANGE

NEW ADDITION TO THE PRODUCT RANGE

- Diameter range
12–37.99 mm

THE APPLICATION

- Continuous and stack drilling with
Walter Xtra-tec® point drill B401 . . .
- For all cast iron materials
- Areas of use: General mechanical
engineering and the automotive industry

THE INDEXABLE INSERT

- Specially developed for drilling
in cast iron
- Red ISO K coating
- Dia. 12–37.99 mm for hole
depths of up to $7 \times D_c$
- Dia. 18–25.80 mm for hole
depths of up to $10 \times D_c$

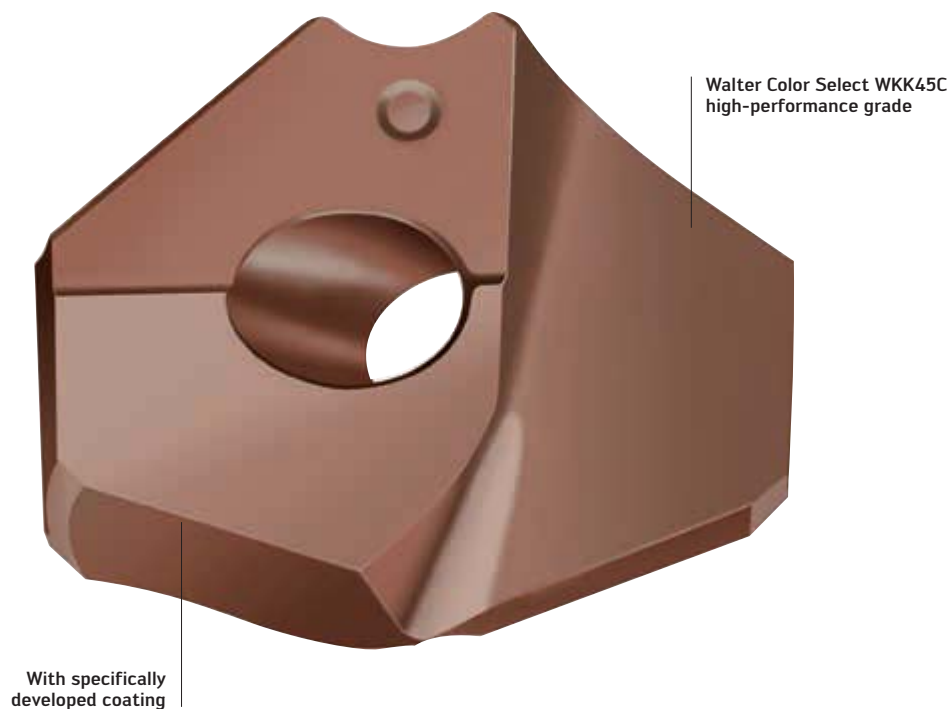

Walter Color Select

Fig.: P6005

BENEFITS FOR YOU

- Up to 100% increase in output at the cutting edge
- Excellent wear resistance with extraordinary temperature resistance
- Excellent wear detection
- Easy selection: The coating corresponds to the ISO colour of the material to be machined
- High degree of process reliability for drilling and withdrawing from deep holes due to force-locking insert clamping

P284 .. and LCMX .. – the new, wear-resistant cutting tool material for drilling.

NEW FOR 2016

THE INDEXABLE INSERTS

- Indexable insert with increased wear resistance thanks to unique aluminium oxide coating
- Tiger-tec® Silver grades optimised for performance: P284 (for Stardrill) and LCMX (for Mini-Stardrill)
- Extremely smooth, low-wear rake face
- Even greater toughness than previous Tiger-tec® CVD and PVD coatings

THE APPLICATION

- WKP25S for ISO P and ISO K materials
- WKP35S for ISO P and ISO K materials
- WSP45S for ISO P, ISO M and ISO S materials

THE GEOMETRIES

A 57 – the stable one:

- Replaces the previous P28467 and P28477 indexable inserts
- For unfavourable machining conditions, particularly for cast iron and steel

E 57 – the universal one:

- Replaces the previous P28475 indexable inserts
- For moderate machining conditions for cast iron and steel as well as stainless and difficult-to-cut materials

E 67 – the easy-cutting one:

- Replaces the previous P28469 and P28479 indexable inserts
- Special geometry for optimum chip formation
- For long-chipping materials (e.g. St37), stainless materials and materials with difficult cutting properties as well as aluminium



Tiger-tec® Silver indexable inserts for drilling

Fig.: P284 ..

BENEFITS FOR YOU

- Up to 100% higher performance thanks to Tiger-tec® Silver technology
- Easier to identify thanks to updated ordering code (P284 and P484)
- Higher workpiece values and productivity
- Shorter set-up and machining times
- Higher machine output and lower total costs
- High process reliability and wear detection

Ordering information
from page 48.

Solid carbide drill with through coolant

A6493TTP



X-treme Inox

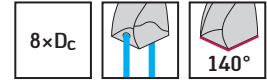
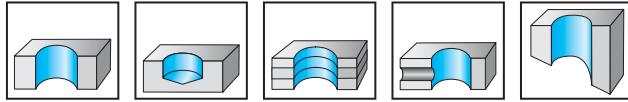

TTP	P	M	K	N	S	H	O
	●	●	●	●	●	●	●

Designation TTP	D _c m7 mm	D _c inches/no.	L _c mm	l ₁ mm	l ₂ mm	l ₅ mm	d ₁ h6 mm
Shank DIN 6535 HA							
★ A6493TTP-3	3		28	74	34	36	6
★ A6493TTP-3.1	3,1		28	74	34	36	6
★ A6493TTP-1/8IN	3,175	1/8"	28	74	34	36	6
★ A6493TTP-3.2	3,2		28	74	34	36	6
★ A6493TTP-3.3	3,3		28	74	34	36	6
★ A6493TTP-3.4	3,4		28	74	34	36	6
★ A6493TTP-3.5	3,5		28	74	34	36	6
★ A6493TTP-3.7	3,7		28	74	34	36	6
★ A6493TTP-3.8	3,8		37	85	45	36	6
★ A6493TTP-3.9	3,9		37	85	45	36	6
★ A6493TTP-4	4		37	85	45	36	6
★ A6493TTP-4.1	4,1		37	85	45	36	6
★ A6493TTP-4.2	4,2		37	85	45	36	6
★ A6493TTP-4.3	4,3		37	85	45	36	6
★ A6493TTP-4.5	4,5		37	85	45	36	6
★ A6493TTP-4.7	4,7		37	85	45	36	6
★ A6493TTP-3/16IN	4,763	3/16"	48	97	57	36	6
★ A6493TTP-4.8	4,8		48	97	57	36	6
★ A6493TTP-5	5		48	97	57	36	6
★ A6493TTP-5.1	5,1		48	97	57	36	6
★ A6493TTP-5.2	5,2		48	97	57	36	6
★ A6493TTP-5.5	5,5		48	97	57	36	6
★ A6493TTP-5.6	5,6		48	97	57	36	6
★ A6493TTP-5.8	5,8		48	97	57	36	6
★ A6493TTP-6	6		48	97	57	36	6
★ A6493TTP-6.1	6,1		55	106	66	36	8
★ A6493TTP-6.2	6,2		55	106	66	36	8
★ A6493TTP-6.3	6,3		55	106	66	36	8
★ A6493TTP-1/4IN	6,35	1/4"	55	106	66	36	8
★ A6493TTP-6.4	6,4		55	106	66	36	8
★ A6493TTP-6.5	6,5		55	106	66	36	8
★ A6493TTP-6.6	6,6		55	106	66	36	8
★ A6493TTP-6.7	6,7		55	106	66	36	8
★ A6493TTP-6.8	6,8		55	106	66	36	8
★ A6493TTP-6.9	6,9		55	106	66	36	8
★ A6493TTP-7	7		55	106	66	36	8
★ A6493TTP-9/32IN	7,144	9/32"	64	116	76	36	8
★ A6493TTP-7.5	7,5		64	116	76	36	8
★ A6493TTP-7.6	7,6		64	116	76	36	8
★ A6493TTP-7.7	7,7		64	116	76	36	8
★ A6493TTP-8	8		64	116	76	36	8
★ A6493TTP-8.1	8,1		80	139	95	40	10
★ A6493TTP-8.2	8,2		80	139	95	40	10
★ A6493TTP-8.4	8,4		80	139	95	40	10
★ A6493TTP-8.5	8,5		80	139	95	40	10
★ A6493TTP-8.6	8,6		80	139	95	40	10
★ A6493TTP-8.7	8,7		80	139	95	40	10

★ New addition to the product range

Continued

Continued

	Designation TTP	D _c m7 mm	D _c inches/no.	L _c mm	l ₁ mm	l ₂ mm	l ₅ mm	d ₁ h6 mm
<p>Shank DIN 6535 HA</p>	★ A6493TTP-8.8	8,8		80	139	95	40	10
	★ A6493TTP-9	9		80	139	95	40	10
	★ A6493TTP-9.2	9,2		80	139	95	40	10
	★ A6493TTP-9.3	9,3		80	139	95	40	10
	★ A6493TTP-9.5	9,5		80	139	95	40	10
	★ A6493TTP-9.8	9,8		80	139	95	40	10
	★ A6493TTP-10	10		80	139	95	40	10
	★ A6493TTP-10.2	10,2		96	163	114	45	12
	★ A6493TTP-10.5	10,5		96	163	114	45	12
	★ A6493TTP-11	11		96	163	114	45	12
	★ A6493TTP-11.5	11,5		96	163	114	45	12
	★ A6493TTP-12	12		96	163	114	45	12
	★ A6493TTP-12.5	12,5		119	182	133	45	14
	★ A6493TTP-13	13		119	182	133	45	14
	★ A6493TTP-14	14		119	182	133	45	14
	★ A6493TTP-15	15		136	204	152	48	16
★ A6493TTP-16	16		136	204	152	48	16	

★ New addition to the product range

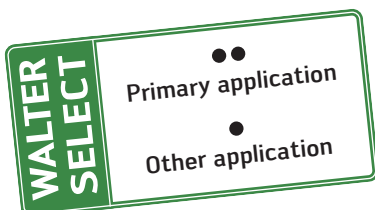

Solid carbide drill with through coolant DC150 Perform

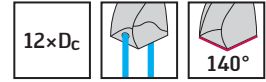
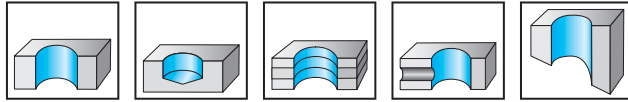

P	M	K	N	S	H	O
●	●	●	●	●	●	●

WJ30TA

Designation	D _c m7 mm	D _c inches/no.	L _c mm	l ₁ mm	l ₂ mm	l ₅ mm	d ₁ h6 mm	WJ30TA
Shank DIN 6535 HA								
DC150-12-03.000A1-	3		48	92	54	36	6	☺☺
DC150-12-03.100A1-	3,1		48	92	54	36	6	☺☺
DC150-12-03.175A1-	3,175	1/8"	48	92	54	36	6	☺☺
DC150-12-03.200A1-	3,2		48	92	54	36	6	☺☺
DC150-12-03.300A1-	3,3		48	92	54	36	6	☺☺
DC150-12-03.400A1-	3,4		48	92	54	36	6	☺☺
DC150-12-03.500A1-	3,5		48	92	54	36	6	☺☺
DC150-12-03.572A1-	3,572	9/64"	48	92	54	36	6	☺☺
DC150-12-03.600A1-	3,6		48	92	54	36	6	☺☺
DC150-12-03.700A1-	3,7		48	92	54	36	6	☺☺
DC150-12-03.800A1-	3,8		56	102	64	36	6	☺☺
DC150-12-03.900A1-	3,9		56	102	64	36	6	☺☺
DC150-12-03.969A1-	3,969	5/32"	56	102	64	36	6	☺☺
DC150-12-04.000A1-	4		56	102	64	36	6	☺☺
DC150-12-04.100A1-	4,1		56	102	64	36	6	☺☺
DC150-12-04.200A1-	4,2		56	102	64	36	6	☺☺
DC150-12-04.300A1-	4,3		56	102	64	36	6	☺☺
DC150-12-04.366A1-	4,366	11/64"	56	102	64	36	6	☺☺
DC150-12-04.400A1-	4,4		56	102	64	36	6	☺☺
DC150-12-04.500A1-	4,5		56	102	64	36	6	☺☺
DC150-12-04.600A1-	4,6		56	102	64	36	6	☺☺
DC150-12-04.700A1-	4,7		56	102	64	36	6	☺☺
DC150-12-04.763A1-	4,763	3/16"	74	121	83	36	6	☺☺
DC150-12-04.800A1-	4,8		74	121	83	36	6	☺☺
DC150-12-04.900A1-	4,9		74	121	83	36	6	☺☺
DC150-12-05.000A1-	5		74	121	83	36	6	☺☺
DC150-12-05.100A1-	5,1		74	121	83	36	6	☺☺
DC150-12-05.159A1-	5,159	13/64"	74	121	83	36	6	☺☺
DC150-12-05.200A1-	5,2		74	121	83	36	6	☺☺
DC150-12-05.300A1-	5,3		74	121	83	36	6	☺☺
DC150-12-05.400A1-	5,4		74	121	83	36	6	☺☺
DC150-12-05.500A1-	5,5		74	121	83	36	6	☺☺
DC150-12-05.550A1-	5,55		74	121	83	36	6	☺☺
DC150-12-05.556A1-	5,556	7/32"	74	121	83	36	6	☺☺
DC150-12-05.600A1-	5,6		74	121	83	36	6	☺☺
DC150-12-05.700A1-	5,7		74	121	83	36	6	☺☺
DC150-12-05.800A1-	5,8		74	121	83	36	6	☺☺
DC150-12-05.900A1-	5,9		74	121	83	36	6	☺☺
DC150-12-06.000A1-	6		74	121	83	36	6	☺☺
DC150-12-06.100A1-	6,1		98	148	110	36	8	☺☺
DC150-12-06.200A1-	6,2		98	148	110	36	8	☺☺
DC150-12-06.300A1-	6,3		98	148	110	36	8	☺☺
DC150-12-06.350A1-	6,35	1/4"	98	148	110	36	8	☺☺
DC150-12-06.400A1-	6,4		98	148	110	36	8	☺☺
DC150-12-06.500A1-	6,5		98	148	110	36	8	☺☺
DC150-12-06.600A1-	6,6		98	148	110	36	8	☺☺

Ordering example for the WJ30TA grade: DC150-12-03.000A1-WJ30TA

Continued

New addition to the product range

Continued

	Designation	D _c m7 mm	D _c inches/no.	L _c mm	l ₁ mm	l ₂ mm	l ₅ mm	d ₁ h6 mm	WJ30TA
	DC150-12-06.700A1-	6,7		98	148	110	36	8	☺☺
	DC150-12-06.747A1-	6,747	17/64"	98	148	110	36	8	☺☺
	DC150-12-06.800A1-	6,8		98	148	110	36	8	☺☺
	DC150-12-06.900A1-	6,9		98	148	110	36	8	☺☺
	DC150-12-07.000A1-	7		98	148	110	36	8	☺☺
	DC150-12-07.100A1-	7,1		98	148	110	36	8	☺☺
	DC150-12-07.144A1-	7,144	9/32"	98	148	110	36	8	☺☺
	DC150-12-07.200A1-	7,2		98	148	110	36	8	☺☺
	DC150-12-07.300A1-	7,3		98	148	110	36	8	☺☺
	DC150-12-07.400A1-	7,4		98	148	110	36	8	☺☺
	DC150-12-07.500A1-	7,5		98	148	110	36	8	☺☺
	DC150-12-07.541A1-	7,541	19/64"	98	148	110	36	8	☺☺
	DC150-12-07.800A1-	7,8		98	148	110	36	8	☺☺
	DC150-12-07.900A1-	7,9		98	148	110	36	8	☺☺
	DC150-12-07.938A1-	7,938	5/16"	98	148	110	36	8	☺☺
	DC150-12-08.000A1-	8		98	148	110	36	8	☺☺
	DC150-12-08.100A1-	8,1		123	180	138	40	10	☺☺
	DC150-12-08.200A1-	8,2		123	180	138	40	10	☺☺
	DC150-12-08.300A1-	8,3		123	180	138	40	10	☺☺
	DC150-12-08.400A1-	8,4		123	180	138	40	10	☺☺
	DC150-12-08.500A1-	8,5		123	180	138	40	10	☺☺
	DC150-12-08.600A1-	8,6		123	180	138	40	10	☺☺
	DC150-12-08.700A1-	8,7		123	180	138	40	10	☺☺
	DC150-12-08.731A1-	8,731	11/32"	123	180	138	40	10	☺☺
	DC150-12-08.800A1-	8,8		123	180	138	40	10	☺☺
	DC150-12-09.000A1-	9		123	180	138	40	10	☺☺
	DC150-12-09.128A1-	9,128	23/64"	123	180	138	40	10	☺☺
	DC150-12-09.200A1-	9,2		123	180	138	40	10	☺☺
	DC150-12-09.300A1-	9,3		123	180	138	40	10	☺☺
	DC150-12-09.500A1-	9,5		123	180	138	40	10	☺☺
DC150-12-09.525A1-	9,525	3/8"	123	180	138	40	10	☺☺	
DC150-12-09.600A1-	9,6		123	180	138	40	10	☺☺	
DC150-12-09.700A1-	9,7		123	180	138	40	10	☺☺	
DC150-12-09.800A1-	9,8		123	180	138	40	10	☺☺	
DC150-12-09.922A1-	9,922	25/64"	123	180	138	40	10	☺☺	
DC150-12-10.000A1-	10		123	180	138	40	10	☺☺	
DC150-12-10.100A1-	10,1		140	206	158	45	12	☺☺	
DC150-12-10.200A1-	10,2		140	206	158	45	12	☺☺	
DC150-12-10.300A1-	10,3		140	206	158	45	12	☺☺	
DC150-12-10.319A1-	10,319	13/32"	140	206	158	45	12	☺☺	
DC150-12-10.500A1-	10,5		140	206	158	45	12	☺☺	
DC150-12-10.716A1-	10,716	27/64"	140	206	158	45	12	☺☺	
DC150-12-10.800A1-	10,8		140	206	158	45	12	☺☺	
DC150-12-11.000A1-	11		140	206	158	45	12	☺☺	
DC150-12-11.100A1-	11,1		140	206	158	45	12	☺☺	
DC150-12-11.113A1-	11,113	7/16"	140	206	158	45	12	☺☺	
DC150-12-11.200A1-	11,2		140	206	158	45	12	☺☺	
DC150-12-11.500A1-	11,5		140	206	158	45	12	☺☺	
DC150-12-11.509A1-	11,509	29/64"	140	206	158	45	12	☺☺	
DC150-12-11.700A1-	11,7		140	206	158	45	12	☺☺	
DC150-12-11.800A1-	11,8		140	206	158	45	12	☺☺	
DC150-12-11.906A1-	11,906	15/32"	140	206	158	45	12	☺☺	
DC150-12-12.000A1-	12		140	206	158	45	12	☺☺	
DC150-12-12.100A1-	12,1		168	230	182	45	14	☺☺	
DC150-12-12.200A1-	12,2		168	230	182	45	14	☺☺	

Ordering example for the WJ30TA grade: DC150-12-03.000A1-WJ30TA

Continued

WALTER SELECT

Best tool for

☺
Good

☹
Average

☹☹
Poor

machining conditions

•• Primary application

• Other application

Continued

	Designation	D _c m7 mm	D _c inches/no.	L _c mm	l ₁ mm	l ₂ mm	l ₅ mm	d ₁ h6 mm	WJ30TA
	Shank DIN 6535 HA								
	DC150-12-12.300A1-	12,3		168	230	182	45	14	
	DC150-12-12.303A1-	12,303	31/64"	168	230	182	45	14	
	DC150-12-12.500A1-	12,5		168	230	182	45	14	
	DC150-12-12.600A1-	12,6		168	230	182	45	14	
	DC150-12-12.700A1-	12,7	1/2"	168	230	182	45	14	
	DC150-12-13.000A1-	13		168	230	182	45	14	
	DC150-12-13.494A1-	13,494	17/32"	168	230	182	45	14	
	DC150-12-13.500A1-	13,5		168	230	182	45	14	
	DC150-12-14.000A1-	14		168	230	182	45	14	
	DC150-12-14.288A1-	14,288	9/16"	192	260	208	48	16	
	DC150-12-14.500A1-	14,5		192	260	208	48	16	
	DC150-12-15.000A1-	15		192	260	208	48	16	
	DC150-12-15.500A1-	15,5		192	260	208	48	16	
	DC150-12-15.875A1-	15,875	5/8"	192	260	208	48	16	
	DC150-12-16.000A1-	16		192	260	208	48	16	
	DC150-12-16.500A1-	16,5		216	285	234	48	18	
	DC150-12-17.000A1-	17		216	285	234	48	18	
	DC150-12-17.500A1-	17,5		216	285	234	48	18	
	DC150-12-18.000A1-	18		216	285	234	48	18	
DC150-12-19.000A1-	19		238	310	258	50	20		
DC150-12-20.000A1-	20		238	310	258	50	20		

Ordering example for the WJ30TA grade: DC150-12-03.000A1-WJ30TA

New addition to the product range

Solid carbide drill with through coolant DC170 Supreme

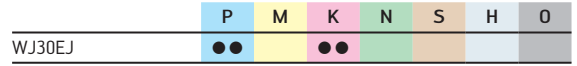
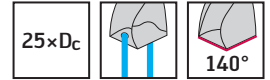
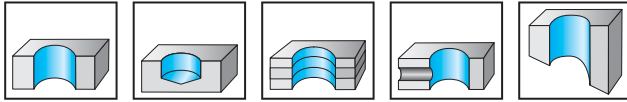

	Designation	D _c h7 mm	D _c inches/no.	L _c mm	l ₁ mm	l ₂ mm	l ₅ mm	d ₁ h6 mm	WJ30EJ
Shank DIN 6535 HA	DC170-25-03.000A1-	3		79	119	84	28	4	●●
	DC170-25-03.175A1-	3,175	1/8"	96	148	102	28	4	●●
	DC170-25-03.500A1-	3,5		108	148	114	28	4	●●
	DC170-25-03.572A1-	3,572	9/64"	108	148	114	28	4	●●
	DC170-25-03.969A1-	3,969	5/32"	108	148	114	28	4	●●
	DC170-25-04.000A1-	4		108	148	114	28	4	●●
	DC170-25-04.500A1-	4,5		138	177	145	28	5	●●
	DC170-25-04.763A1-	4,763	3/16"	137	177	145	28	5	●●
	DC170-25-04.800A1-	4,8		137	177	145	28	5	●●
	DC170-25-05.000A1-	5		137	177	145	28	5	●●
	DC170-25-05.500A1-	5,5		151	200	160	36	6	●●
	DC170-25-05.556A1-	5,556	7/32"	165	214	174	36	6	●●
	DC170-25-06.000A1-	6		165	214	174	36	6	●●
	DC170-25-06.100A1-	6,1		183	234	194	36	8	●●
	DC170-25-06.350A1-	6,35	1/4"	183	234	194	36	8	●●
	DC170-25-06.500A1-	6,5		183	234	194	36	8	●●
	DC170-25-06.800A1-	6,8		183	234	194	36	8	●●
	DC170-25-07.000A1-	7		183	234	194	36	8	●●
	DC170-25-07.144A1-	7,144	9/32"	208	260	220	36	8	●●
	DC170-25-07.938A1-	7,938	5/16"	208	260	220	36	8	●●
	DC170-25-08.000A1-	8		208	260	220	36	8	●●
	DC170-25-08.500A1-	8,5		229	289	243	40	10	●●
	DC170-25-08.731A1-	8,731	11/32"	229	289	243	40	10	●●
DC170-25-09.000A1-	9		229	289	243	40	10	●●	
DC170-25-09.525A1-	9,525	3/8"	255	314	270	40	10	●●	
DC170-25-09.800A1-	9,8		255	314	270	40	10	●●	
DC170-25-10.000A1-	10		255	314	270	40	10	●●	
DC170-25-10.200A1-	10,2		280	346	297	45	12	●●	
DC170-25-11.000A1-	11		280	346	297	45	12	●●	
DC170-25-11.113A1-	11,113	7/16"	306	373	324	45	12	●●	
DC170-25-11.500A1-	11,5		306	373	324	45	12	●●	
DC170-25-12.000A1-	12		306	373	324	45	12	●●	

Ordering example for the WJ30EJ grade: DC170-25-03.000A1-WJ30EJ

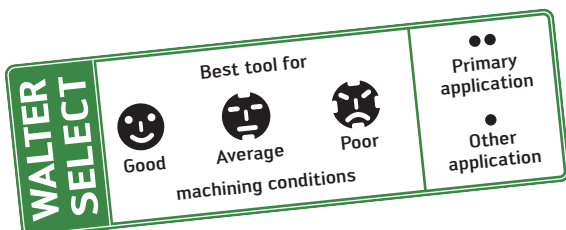

Solid carbide drill with through coolant DC170 Supreme

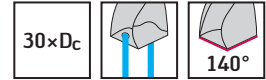
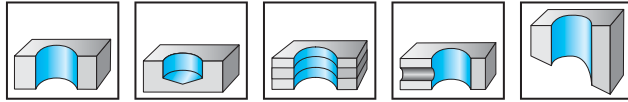

	P	M	K	N	S	H	O
WJ30EJ	●●		●●				

Designation	D _c h7 mm	D _c inches/no.	L _c mm	l ₁ mm	l ₂ mm	l ₅ mm	d ₁ h6 mm	WJ30EJ
Shank DIN 6535 HA								
DC170-30-03.000A1-	3		92	132	97	28	4	☺☺
DC170-30-03.175A1-	3,175	1/8"	114	166	120	28	4	☺☺
DC170-30-03.500A1-	3,5		127	166	133	28	4	☺☺
DC170-30-03.969A1-	3,969	5/32"	127	166	133	28	4	☺☺
DC170-30-04.000A1-	4		127	166	133	28	4	☺☺
DC170-30-04.500A1-	4,5		162	200	169	28	5	☺☺
DC170-30-04.763A1-	4,763	3/16"	161	200	169	28	5	☺☺
DC170-30-04.800A1-	4,8		161	200	169	28	5	☺☺
DC170-30-05.000A1-	5		161	200	169	28	5	☺☺
DC170-30-05.500A1-	5,5		178	225	187	36	6	☺☺
DC170-30-05.556A1-	5,556	7/32"	195	242	204	36	6	☺☺
DC170-30-06.000A1-	6		195	242	204	36	6	☺☺
DC170-30-06.350A1-	6,35	1/4"	217	268	228	36	8	☺☺
DC170-30-06.500A1-	6,5		217	268	228	36	8	☺☺
DC170-30-06.800A1-	6,8		217	268	228	36	8	☺☺
DC170-30-07.000A1-	7		217	268	228	36	8	☺☺
DC170-30-07.400A1-	7,4		244	294	256	36	8	☺☺
DC170-30-07.938A1-	7,938	5/16"	244	294	256	36	8	☺☺
DC170-30-08.000A1-	8		244	294	256	36	8	☺☺
DC170-30-08.500A1-	8,5		273	330	287	40	10	☺☺
DC170-30-08.731A1-	8,731	11/32"	273	330	287	40	10	☺☺
DC170-30-09.000A1-	9		273	330	287	40	10	☺☺
DC170-30-09.525A1-	9,525	3/8"	305	364	320	40	10	☺☺
DC170-30-10.000A1-	10		305	364	320	40	10	☺☺
DC170-30-10.200A1-	10,2		335	401	352	45	12	☺☺
DC170-30-11.000A1-	11		335	401	352	45	12	☺☺
DC170-30-11.113A1-	11,113	7/16"	364	430	382	45	12	☺☺
DC170-30-12.000A1-	12		364	430	382	45	12	☺☺

Ordering example for the WJ30EJ grade: DC170-30-03.000A1-WJ30EJ

☺☺☺ New addition to the product range

Drill Inserts P6001, P6003, P6004, P6005

For Xtra-tec® Point Drill

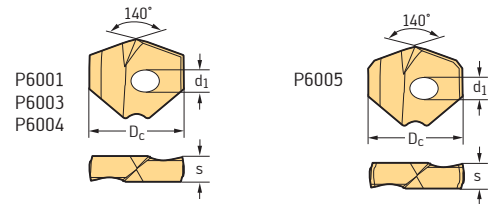

Drill Inserts						P6001	P6003	P6003	P6005	P6004	P6003
Designation	Cutting edges	D _c mm	D _c inches/no.	d ₁ mm	s mm	P	P	M	K	N	S
						HC	HC	HC	HC	HC	HC
						WPP45C	WMP35	WMP35	WKK45C	WNN25	WMP35
P6001 	P60...-D12,00R	2	12,00		3	3,6	☺	☺	☺	☺	☺
	P60...-D12,10R	2	12,10		3	3,6	☺	☺	☺	☺	☺
	P60...-D12,20R	2	12,20		3	3,6	☺	☺	☺	☺	☺
	P60...-D12,30R	2	12,30		3	3,6	☺	☺	☺	☺	☺
	P60...-D12,40R	2	12,40		3	3,6	☺	☺	☺	☺	☺
P6003 	P60...-D12,50R	2	12,50		3	3,6	☺	☺	☺	☺	☺
	P60...-D12,60R	2	12,60		3	3,6	☺	☺	☺	☺	☺
	P60...-D12,70R	2	12,70	1/2"	3	3,6	☺	☺	☺	☺	☺
	P60...-D12,80R	2	12,80		3	3,6	☺	☺	☺	☺	☺
	P60...-D12,90R	2	12,90		3	3,6	☺	☺	☺	☺	☺
P6004 	P60...-D12,95R	2	12,95		3	3,6	☺	☺	☺	☺	☺
	P60...-D13,00R	2	13,00		3	3,6	☺	☺	☺	☺	☺
	P60...-D13,11R	2	13,11	33/64"	3	3,6	☺	☺	☺	☺	☺
	P60...-D13,20R	2	13,20		3	3,6	☺	☺	☺	☺	☺
	P60...-D13,25R	2	13,25		3	3,6	☺	☺	☺	☺	☺
P6005 	P60...-D13,30R	2	13,30		3	3,6	☺	☺	☺	☺	☺
	P60...-D13,40R	2	13,40		3	3,6	☺	☺	☺	☺	☺
	P60...-D13,50R	2	13,50	17/32"	3	3,6	☺	☺	☺	☺	☺
	P60...-D13,60R	2	13,60		3	3,6	☺	☺	☺	☺	☺
	P60...-D13,70R	2	13,70		3	3,6	☺	☺	☺	☺	☺
	P60...-D13,80R	2	13,80		3	3,6	☺	☺	☺	☺	☺
	P60...-D13,89R	2	13,89	35/64"	3	3,6	☺	☺	☺	☺	☺
	P60...-D14,00R	2	14,00		3	4,0	☺	☺	☺	☺	☺
	P60...-D14,10R	2	14,10		3	4,0	☺	☺	☺	☺	☺
	P60...-D14,20R	2	14,20		3	4,0	☺	☺	☺	☺	☺
	P60...-D14,30R	2	14,30	9/16"	3	4,0	☺	☺	☺	☺	☺
	P60...-D14,40R	2	14,40		3	4,0	☺	☺	☺	☺	☺
	P60...-D14,50R	2	14,50		3	4,0	☺	☺	☺	☺	☺
	P60...-D14,60R	2	14,60		3	4,0	☺	☺	☺	☺	☺
	P60...-D14,68R	2	14,68	37/64"	3	4,0	☺	☺	☺	☺	☺
	P60...-D14,80R	2	14,80		3	4,0	☺	☺	☺	☺	☺
	P60...-D14,90R	2	14,90		3	4,0	☺	☺	☺	☺	☺
	P60...-D15,00R	2	15,00		3	4,0	☺	☺	☺	☺	☺
	P60...-D15,09R	2	15,09	19/32"	3	4,0	☺	☺	☺	☺	☺
	P60...-D15,20R	2	15,20		3	4,0	☺	☺	☺	☺	☺
	P60...-D15,30R	2	15,30		3	4,0	☺	☺	☺	☺	☺
	P60...-D15,40R	2	15,40		3	4,0	☺	☺	☺	☺	☺
	P60...-D15,47R	2	15,47	39/64"	3	4,0	☺	☺	☺	☺	☺
	P60...-D15,50R	2	15,50		3	4,0	☺	☺	☺	☺	☺
	P60...-D15,60R	2	15,60		3	4,0	☺	☺	☺	☺	☺
	P60...-D15,70R	2	15,70		3	4,0	☺	☺	☺	☺	☺
	P60...-D15,80R	2	15,80		3	4,0	☺	☺	☺	☺	☺
	P60...-D15,87R	2	15,87	5/8"	3	4,0	☺	☺	☺	☺	☺
	P60...-D16,00R	2	16,00		4	4,5	☺	☺	☺	☺	☺
	P60...-D16,13R	2	16,13		4	4,5	☺	☺	☺	☺	☺
P60...-D16,26R	2	16,26	41/64"	4	4,5	☺	☺	☺	☺	☺	

Ordering example: P60...-D13,00R is available as P6003 in grade WMP35 (ISO P, ISO M and ISO S) → **P6003-D13,00R WMP35** or as P6001 in grade WXP45 (ISO P) → **P6001-D13,00R WXP45**

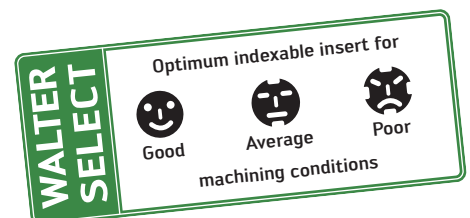

Drill Inserts

P6001, P6003, P6004, P6005

For Xtra-tec® Point Drill

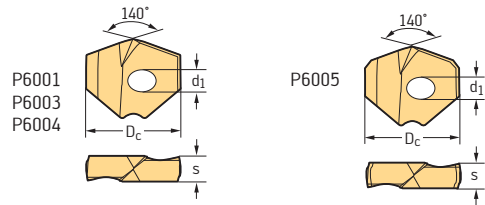

Drill Inserts

Designation	Cutting edges	D _c mm	D _c inches/no.	d ₁ mm	s mm	P6001	P6003	P6003	P6005	P6004	P6003
						P HC WPP45C	P HC WMP35	M HC WMP35	K HC WKK45C	N HC WNN25	S HC WMP35
P6001 	P60...-D16,43R	2	16,43		4	4,5	☺	☺	☺	☹	☺
	P60...-D16,50R	2	16,50		4	4,5	☺	☺	☺	☺	☺
	P60...-D16,66R	2	16,66	21/32"	4	4,5	☺	☺	☺	☺	☺
	P60...-D16,70R	2	16,70		4	4,5	☺	☺	☺	☺	☺
	P60...-D17,00R	2	17,00		4	4,5	☺	☺	☺	☺	☺
P6003 	P60...-D17,07R	2	17,07	43/64"	4	4,5	☺	☺	☺	☺	☺
	P60...-D17,45R	2	17,45	11/16"	4	4,5	☺	☺	☺	☺	☺
	P60...-D17,50R	2	17,50		4	4,5	☺	☺	☺	☺	☺
	P60...-D17,70R	2	17,70		4	4,5	☺	☺	☺	☺	☺
	P60...-D17,86R	2	17,86	45/64"	4	4,5	☺	☺	☺	☺	☺
P6004 	P60...-D18,00R	2	18,00		4	5,0	☺	☺	☺	☺	☺
	P60...-D18,24R	2	18,24	23/32"	4	5,0	☺	☺	☺	☺	☺
	P60...-D18,50R	2	18,50		4	5,0	☺	☺	☺	☺	☺
	P60...-D18,65R	2	18,65	47/64"	4	5,0	☺	☺	☺	☺	☺
	P60...-D18,70R	2	18,70		4	5,0	☺	☺	☺	☺	☺
P6005 	P60...-D18,80R	2	18,80		4	5,0	☺	☺	☺	☺	☺
	P60...-D19,00R	2	19,00		4	5,0	☺	☺	☺	☺	☺
	P60...-D19,05R	2	19,05	3/4"	4	5,0	☺	☺	☺	☺	☺
	P60...-D19,20R	2	19,20		4	5,0	☺	☺	☺	☺	☺
	P60...-D19,25R	2	19,25		4	5,0	☺	☺	☺	☺	☺
	P60...-D19,30R	2	19,30		4	5,0	☺	☺	☺	☺	☺
	P60...-D19,43R	2	19,43	49/64"	4	5,0	☺	☺	☺	☺	☺
	P60...-D19,50R	2	19,50		4	5,0	☺	☺	☺	☺	☺
	P60...-D19,60R	2	19,60		4	5,0	☺	☺	☺	☺	☺
	P60...-D19,70R	2	19,70		4	5,0	☺	☺	☺	☺	☺
	P60...-D19,84R	2	19,84	25/32"	4	5,0	☺	☺	☺	☺	☺
	P60...-D20,00R	2	20,00		5	5,5	☺	☺	☺	☺	☺
	P60...-D20,20R	2	20,20		5	5,5	☺	☺	☺	☺	☺
	P60...-D20,24R	2	20,24	51/64"	5	5,5	☺	☺	☺	☺	☺
	P60...-D20,50R	2	20,50		5	5,5	☺	☺	☺	☺	☺
P60...-D20,62R	2	20,62	13/16"	5	5,5	☺	☺	☺	☺	☺	
P60...-D20,70R	2	20,70		5	5,5	☺	☺	☺	☺	☺	
P60...-D21,00R	2	21,00		5	5,5	☺	☺	☺	☺	☺	
P60...-D21,41R	2	21,41	27/32"	5	5,5	☺	☺	☺	☺	☺	
P60...-D21,50R	2	21,50		5	5,5	☺	☺	☺	☺	☺	
P60...-D21,70R	2	21,70		5	5,5	☺	☺	☺	☺	☺	
P60...-D21,83R	2	21,83		5	5,5	☺	☺	☺	☺	☺	
P60...-D22,00R	2	22,00		5	6,0	☺	☺	☺	☺	☺	
P60...-D22,22R	2	22,22	7/8"	5	6,0	☺	☺	☺	☺	☺	
P60...-D22,42R	2	22,42		5	6,0	☺	☺	☺	☺	☺	
P60...-D22,47R	2	22,47		5	6,0	☺	☺	☺	☺	☺	
P60...-D22,50R	2	22,50		5	6,0	☺	☺	☺	☺	☺	
P60...-D22,62R	2	22,62		5	6,0	☺	☺	☺	☺	☺	
P60...-D22,70R	2	22,70		5	6,0	☺	☺	☺	☺	☺	
P60...-D22,77R	2	22,77		5	6,0	☺	☺	☺	☺	☺	
P60...-D23,00R	2	23,00	29/32"	5	6,0	☺	☺	☺	☺	☺	
P60...-D23,39R	2	23,39		5	6,0	☺	☺	☺	☺	☺	
P60...-D23,50R	2	23,50		5	6,0	☺	☺	☺	☺	☺	

Ordering example: P60...-D13,00R is available as P6003 in grade WMP35 (ISO P, ISO M and ISO S) → **P6003-D13,00R WMP35** or as P6001 in grade WXP45 (ISO P) → **P6001-D13,00R WXP45**

☺ ☹ ☹ New addition to the product range

Drill Inserts P6001, P6003, P6004, P6005

For Xtra-tec® Point Drill

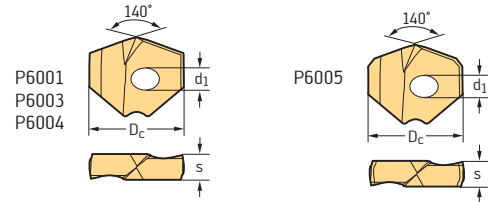

Drill Inserts						P6001	P6003	P6003	P6005	P6004	P6003
Designation	Cutting edges	D _c mm	D _c inches/no.	d ₁ mm	s mm	P	P	M	K	N	S
						HC	HC	HC	HC	HC	HC
						WPP45C	WMP35	WMP35	WKK45C	WNN25	WMP35
P6001 	P60...-D23,70R	2	23,70		5	6,0	☺	☺	☺		☺
	P60...-D23,80R	2	23,80	15/16"	5	6,0	☺	☺	☺		☺
	P60...-D24,00R	2	24,00		5	6,5	☺	☺	☺	☺	☺
	P60...-D24,21R	2	24,21		5	6,5	☺	☺	☺	☺	☺
	P60...-D24,50R	2	24,50		5	6,5	☺	☺	☺	☺	☺
P6003 	P60...-D24,59R	2	24,59	31/32"	5	6,5	☺	☺	☺		☺
	P60...-D24,70R	2	24,70		5	6,5	☺	☺	☺		☺
	P60...-D25,00R	2	25,00		5	6,5	☺	☺	☺	☺	☺
	P60...-D25,25R	2	25,25		5	6,5	☺	☺	☺	☺	☺
	P60...-D25,40R	2	25,40	1"	5	6,5	☺	☺	☺	☺	☺
P6004 	P60...-D25,50R	2	25,50		5	6,5	☺	☺	☺	☺	☺
	P60...-D25,65R	2	25,65		5	6,5	☺	☺	☺	☺	☺
	P60...-D25,70R	2	25,70		5	6,5	☺	☺	☺	☺	☺
	P60...-D25,80R	2	25,80		5	6,5	☺	☺	☺	☺	☺
	P60...-D26,00R	2	26,00		6	7,1	☺	☺	☺	☺	☺
P6005 	P60...-D26,25R	2	26,25		6	7,1	☺	☺	☺	☺	☺
	P60...-D26,50R	2	26,50		6	7,1	☺	☺	☺	☺	☺
	P60...-D26,59R	2	26,59		6	7,1	☺	☺	☺	☺	☺
	P60...-D27,00R	2	27,00		6	7,1	☺	☺	☺	☺	☺
	P60...-D27,38R	2	27,38		6	7,1	☺	☺	☺	☺	☺
	P60...-D27,50R	2	27,50		6	7,1	☺	☺	☺	☺	☺
	P60...-D27,78R	2	27,78		6	7,1	☺	☺	☺	☺	☺
	P60...-D28,00R	2	28,00		6	7,7	☺	☺	☺	☺	☺
	P60...-D28,17R	2	28,17		6	7,7	☺	☺	☺	☺	☺
	P60...-D28,50R	2	28,50		6	7,7	☺	☺	☺	☺	☺
P60...-D28,57R	2	28,57		6	7,7	☺	☺	☺	☺	☺	
P60...-D29,00R	2	29,00		6	7,7	☺	☺	☺	☺	☺	
P60...-D29,37R	2	29,37		6	7,7	☺	☺	☺	☺	☺	
P60...-D29,50R	2	29,50		6	7,7	☺	☺	☺	☺	☺	
P60...-D29,77R	2	29,77		6	7,7	☺	☺	☺	☺	☺	
P60...-D30,00R	2	30,00		6	8,0	☺	☺	☺	☺	☺	
P60...-D30,15R	2	30,15		6	8,0	☺	☺	☺	☺	☺	
P60...-D30,50R	2	30,50		6	8,0	☺	☺	☺	☺	☺	
P60...-D31,00R	2	31,00		6	8,0	☺	☺	☺	☺	☺	
P60...-D31,50R	2	31,50		6	8,0	☺	☺	☺	☺	☺	
P60...-D31,75R	2	31,75	1 1/4"	6	8,0	☺	☺	☺	☺	☺	
P60...-D31,99R	2	31,99		6	8,0	☺	☺	☺	☺	☺	
P60...-D32,00R	2	32,00		6,2	8,29	☺	☺	☺	☺	☺	
P60...-D32,10R	2	32,10		6,2	8,29	☺	☺	☺	☺	☺	
P60...-D33,00R	2	33,00		6,2	8,29	☺	☺	☺	☺	☺	
P60...-D34,00R	2	34,00		6,2	8,29	☺	☺	☺	☺	☺	
P60...-D35,00R	2	35,00		6,2	8,29	☺	☺	☺	☺	☺	
P60...-D36,00R	2	36,00		6,2	8,29	☺	☺	☺	☺	☺	
P60...-D37,00R	2	37,00		6,2	8,29	☺	☺	☺	☺	☺	
P60...-D37,99R	2	37,99		6,2	8,29	☺	☺	☺	☺	☺	

Ordering example: P60...-D13,00R is available as P6003 in grade WMP35 (ISO P, ISO M and ISO S) → P6003-D13,00R WMP35 or as P6001 in grade WXP45 (ISO P) → P6001-D13,00R WXP45

WALTER SELECT

Optimum indexable insert for

☺
Good

☹
Average

☹
Poor

machining conditions

Square insert - Stardrill P284..

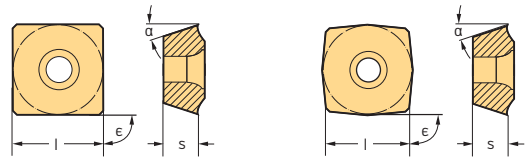

Indexable inserts

Designation	Number of cutting edges	l mm	s mm	α	ϵ	P					M			K			S		
						HC					HC			HC			HC		
						WKP255	WKP355	WSP45	WSP45S	WXP40	WSP45	WSP45S	WXP40	WAK15	WKP255	WKP355	WXP40	WSP45	WSP45S
	P2840S-1N-A57	4	6,35	2,38	14°	90°	☺	☺	☺	☺	☺	☺	☺	☺	☺	☺	☺	☺	☺
	P2840S-2N-A57	4	7,8	3,18	14°	90°	☺	☺	☺	☺	☺	☺	☺	☺	☺	☺	☺	☺	☺
	P2840S-3N-A57	4	9,52	3,97	11°	96°	☺	☺	☺	☺	☺	☺	☺	☺	☺	☺	☺	☺	☺
	P2840S-4N-A57	4	11	3,97	11°	96°	☺	☺	☺	☺	☺	☺	☺	☺	☺	☺	☺	☺	☺
	P2840S-5N-A57	4	12,7	4,76	11°	96°	☺	☺	☺	☺	☺	☺	☺	☺	☺	☺	☺	☺	☺
	P2840S-1N-E67	4	6,35	2,38	14°	90°	☺	☺	☺	☺	☺	☺	☺	☺	☺	☺	☺	☺	☺
	P2840S-2N-E67	4	7,8	3,18	14°	90°	☺	☺	☺	☺	☺	☺	☺	☺	☺	☺	☺	☺	☺
	P2840S-3N-E67	4	9,52	3,97	11°	96°	☺	☺	☺	☺	☺	☺	☺	☺	☺	☺	☺	☺	☺
	P2840S-4N-E67	4	11	3,97	11°	96°	☺	☺	☺	☺	☺	☺	☺	☺	☺	☺	☺	☺	☺
	P2840S-5N-E67	4	12,7	4,76	11°	96°	☺	☺	☺	☺	☺	☺	☺	☺	☺	☺	☺	☺	☺
	P2841S-1N-A57	4	6,35	2,38	14°	90°	☺	☺	☺	☺	☺	☺	☺	☺	☺	☺	☺	☺	☺
	P2841S-2N-A57	4	7,8	3,18	14°	90°	☺	☺	☺	☺	☺	☺	☺	☺	☺	☺	☺	☺	☺
	P2841S-3N-A57	4	9,52	3,97	11°	96°	☺	☺	☺	☺	☺	☺	☺	☺	☺	☺	☺	☺	☺
	P2841S-4N-A57	4	11	3,97	11°	96°	☺	☺	☺	☺	☺	☺	☺	☺	☺	☺	☺	☺	☺
	P2841S-5N-A57	4	12,7	4,76	11°	96°	☺	☺	☺	☺	☺	☺	☺	☺	☺	☺	☺	☺	☺
	P2841S-1N-E57	4	6,35	2,38	14°	90°	☺	☺	☺	☺	☺	☺	☺	☺	☺	☺	☺	☺	☺
	P2841S-2N-E57	4	7,8	3,18	14°	90°	☺	☺	☺	☺	☺	☺	☺	☺	☺	☺	☺	☺	☺
	P2841S-3N-E57	4	9,52	3,97	11°	96°	☺	☺	☺	☺	☺	☺	☺	☺	☺	☺	☺	☺	☺
	P2841S-4N-E57	4	11	3,97	11°	96°	☺	☺	☺	☺	☺	☺	☺	☺	☺	☺	☺	☺	☺
	P2841S-5N-E57	4	12,7	4,76	11°	96°	☺	☺	☺	☺	☺	☺	☺	☺	☺	☺	☺	☺	☺
	P2841S-1N-E67	4	6,35	2,38	14°	90°	☺	☺	☺	☺	☺	☺	☺	☺	☺	☺	☺	☺	☺
	P2841S-2N-E67	4	7,8	3,18	14°	90°	☺	☺	☺	☺	☺	☺	☺	☺	☺	☺	☺	☺	☺
	P2841S-3N-E67	4	9,52	3,97	11°	96°	☺	☺	☺	☺	☺	☺	☺	☺	☺	☺	☺	☺	☺
	P2841S-4N-E67	4	11	3,97	11°	96°	☺	☺	☺	☺	☺	☺	☺	☺	☺	☺	☺	☺	☺
	P2841S-5N-E67	4	12,7	4,76	11°	96°	☺	☺	☺	☺	☺	☺	☺	☺	☺	☺	☺	☺	☺



HC = Coated carbide

New addition to the product range

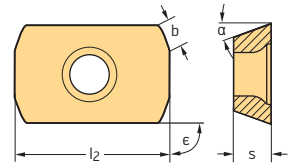
Rectangular insert - Mini Stardrill LCMX



Indexable inserts

Designation	Number of cutting edges	l ₂ mm	s mm	α	ε	P				M			K				S		
						HC				HC			HC				HC		
						WKP255	WKP355	WSP45	WSP45S	WXP40	WSP45	WSP45S	WXP40	WAK15	WKP255	WKP355	WXP40	WSP45	WSP45S
 LCMX050203-B57	2	5,2	2,38	7°	90°	☺	☺			☹			☺	☺	☹			☹	
LCMX06T204-B57	2	6,6	2,78	7°	90°	☺	☺			☹			☺	☺	☹			☹	
 LCMX050203-D57	2	5,2	2,38	7°	90°	☺	☺	☹	☹	☹	☹	☹	☺	☺	☹			☹	
LCMX06T204-D57	2	6,6	2,78	7°	90°	☺	☺	☹	☹	☹	☹	☹	☺	☺	☹			☹	
 LCMX050203-E57	2	5,2	2,38	7°	90°	☺	☺	☹	☹	☹	☹	☹	☺	☺	☹			☹	
LCMX06T204-E57	2	6,6	2,78	7°	90°	☺	☺	☹	☹	☹	☹	☹	☺	☺	☹			☹	

HC = Coated carbide

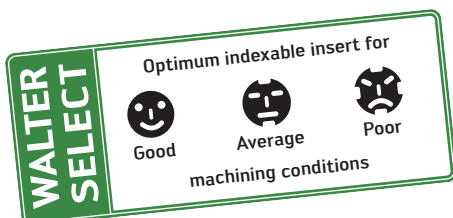

Cutting data for solid carbide drills

Material group	= Cutting data for wet machining = Dry machining is possible, cutting data must be selected from Walter GPS. E = Emulsion O = Oil M = MQL L = Dry v _c = Cutting speed VRR = Feed rate chart		Drilling depth			8 × D _c				
			Product family			A6493TTP				
			Product line			–				
			Dimensions			Walter standard				
Ø range (mm)			3,00–16,00							
Cooling			Internal coolant							
Cutting material			K30F - TTP							
Page			38							
Overview of the main material groups and code letters			Brinell hardness HB	Tensile strength R _m N/mm ²	Machining group					
Material						v _c	VRR			
P	Non-alloyed steel	C ≤ 0.25%	Annealed	125	430	P1	150	10	E O	M L
		C > 0.25... ≤ 0.55%	Annealed	190	640	P2	110	10	E O	M L
		C > 0.25... ≤ 0.55%	Heat-treated	210	710	P3	100	10	E O	M L
		C > 0.55%	Annealed	190	640	P4	110	10	E O	M L
		C > 0.55%	Heat-treated	300	1010	P5				
		Free cutting steel (short-chipping)	Annealed	220	750	P6	135	12	E O	M L
	Low-alloyed steel	Annealed	175	590	P7	110	10	E O	M L	
		Heat-treated	285	960	P8					
		Heat-treated	380	1280	P9					
		Heat-treated	430	1480	P10					
	High-alloyed steel and high-alloyed tool steel	Annealed	200	680	P11					
		Hardened and tempered	300	1010	P12					
		Hardened and tempered	380	1280	P13					
	Stainless steel	Ferritic/martensitic, annealed	200	680	P14	90	9	E O		
		Martensitic, heat-treated	330	1110	P15	50	8	E O		
M	Stainless steel	Austenitic, quench hardened	200	680	M1	50	6	E O		
		Austenitic, precipitation hardened (PH)	300	1010	M2	65	6	E O		
		Austenitic/ferritic, duplex	230	780	M3	50	6	E O		
K	Malleable cast iron	Ferritic	200	400	K1					
		Pearlitic	260	700	K2					
	Grey cast iron	Low tensile strength	180	200	K3					
		High tensile strength/austenitic	245	350	K4					
	Cast iron with spheroidal graphite	Ferritic	155	400	K5					
		Pearlitic	265	700	K6					
	GGV (CGI)		230	400	K7					
N	Aluminium wrought alloys	Cannot be hardened	30	–	N1	450	16	E O	M	
		Hardenable, hardened	100	340	N2	450	16	E O	M	
	Cast aluminium alloys	≤ 12% Si, cannot be hardened	75	260	N3	250	16	E O	M	
		≤ 12% Si, hardenable, hardened	90	310	N4	240	16	E O	M	
	Magnesium alloys ³	> 12% Si, cannot be hardened	130	450	N5	190	16	E O	M	
			70	250	N6	240	16		M L	
Copper and copper alloys (bronze/brass)	Non-alloyed, electrolytic copper		100	340	N7	210	9	E O	M	
	Brass, bronze, red brass		90	310	N8	180	12	E O		
	Cu-alloys, short-chipping		110	380	N9	190	16	E O	M	
	High-strength, Ampco		300	1010	N10	60	7	E O		
S	Heat-resistant alloys	Fe-based	Annealed	200	680	S1	48	6	E O	
			Hardened	280	940	S2	36	5	O E	
		Ni or Co base	Annealed	250	840	S3	40	5	E O	
			Hardened	350	1180	S4	24	4	O E	
			Cast	320	1080	S5	30	4	O E	
	Titanium alloys	Pure titanium	200	680	S6	60	6	O E		
	α and β alloys, hardened	375	1260	S7	53	5	O E			
	β alloys	410	1400	S8	18	4	O E			
	Tungsten alloys	300	1010	S9	120	9	E O			
	Molybdenum alloys	300	1010	S10	120	9	E O			
H	Hardened steel	Hardened and tempered	50 HRC	–	H1					
		Hardened and tempered	55 HRC	–	H2					
		Hardened and tempered	60 HRC	–	H3					
Hardened cast iron	Hardened and tempered	55 HRC	–	H4						
O	Thermoplastics	Without abrasive fillers			O1	130	16	E O		
	Thermosetting plastics	Without abrasive fillers			O2					
	Plastic, glass-fibre-reinforced	GFRP			O3					
	Plastic, carbon-fibre-reinforced	CFRP			O4					
	Plastic, aramid-fibre-reinforced	AFRP			O5					
	Graphite (technical)		80 Shore			O6				

¹ The classification of machining groups can be found from page H 8 onwards in the Walter General Catalogue 2012.

³ Water-miscible coolants must not be used when machining magnesium alloys.

The specified cutting data are average recommended values.
For special applications, adjustment is recommended.

	12 × D _c				25 × D _c				30 × D _c			
	DC150				DC170				DC170			
	Perform				Supreme				Supreme			
	Walter standard				Walter standard				Walter standard			
	3,00–20,00				3,00–12,00				3,00–12,00			
	Internal coolant				Internal coolant				Internal coolant			
	WJ30TA				WJ30EJ				WJ30EJ			
	40				43				44			
	v _c	VRR			v _c	VRR			v _c	VRR		
100	10	EO	ML		141	12	EO	ML	140	12	EO	ML
83	10	EO	ML		128	12	EO	ML	127	12	EO	ML
79	10	EO	ML		123	12	EO	ML	122	12	EO	ML
83	10	EO	ML		128	12	EO	ML	127	12	EO	ML
59	7	EO	ML		98	9	EO	ML	97	9	EO	ML
100	12	EO	ML		136	10	EO	ML	135	10	EO	ML
83	10	EO	ML		123	10	EO		122	10	EO	
59	7	EO	ML		98	9	EO		97	9	EO	
40	6	OE			59	7	OE		58	7	OE	
31	4	OE			39	6	OE		39	6	OE	
52	8	EO			66	9	EO		65	9	EO	
47	6	EO			83	8	EO		82	8	EO	
31	3	OE			39	6	OE		39	6	OE	
52	8	EO			65	8	EO		64	8	EO	
34	6	EO			37	7	EO		37	7	EO	
37	5	EO										
47	6	EO										
30	5	EO										
73	12	EO	ML		93	16	EO	ML	92	16	EO	ML
55	12	EO	ML		68	12	EO	ML	67	12	EO	ML
93	12	EO	ML		113	16	EO	ML	112	16	EO	ML
73	12	EO	ML		93	16	EO	ML	92	16	EO	ML
73	12	EO	ML		111	16	EO	ML	110	16	EO	ML
55	12	EO	ML		88	12	EO	ML	87	12	EO	ML
66	12	EO	ML		101	16	EO	ML	100	16	EO	ML
380	16	EO	M									
380	16	EO	M									
203	16	EO	M									
194	16	EO	M									
154	16	EO	M									
194	16		ML									
146	7	EO	M									
122	9	EO										
154	12	EO	M									
46	6	EO										
39	5	EO										
23	4	OE										
27	4	EO										
15	3	OE										
17	3	OE										
45	6	OE										
37	5	OE										
11	3	OE										
52	7	EO										
52	7	EO										
25	3	OE										
21	3	OE										
21	3	OE										
95	16	EO										

VRR: Feed rate charts for drills

VRR	Feed f (mm/rev) for Ø (mm)								
	2,5	4	5	6	8	10	12	15	20
1	0,008	0,013	0,017	0,018	0,021	0,024	0,026	0,029	0,033
2	0,017	0,027	0,033	0,037	0,042	0,047	0,052	0,058	0,067
3	0,025	0,040	0,050	0,055	0,063	0,071	0,077	0,087	0,10
4	0,033	0,053	0,067	0,073	0,084	0,094	0,10	0,12	0,13
5	0,042	0,067	0,083	0,091	0,11	0,12	0,13	0,14	0,17
6	0,050	0,080	0,10	0,11	0,13	0,14	0,15	0,17	0,20
7	0,058	0,093	0,12	0,13	0,15	0,16	0,18	0,20	0,23
8	0,067	0,11	0,13	0,15	0,17	0,19	0,21	0,23	0,27
9	0,075	0,12	0,15	0,16	0,19	0,21	0,23	0,26	0,30
10	0,083	0,13	0,17	0,18	0,21	0,24	0,26	0,29	0,33
12	0,10	0,16	0,20	0,22	0,25	0,28	0,31	0,35	0,40
16	0,13	0,21	0,27	0,29	0,34	0,38	0,41	0,46	0,53
20	0,17	0,27	0,33	0,37	0,42	0,47	0,52	0,58	0,67

TC115 Perform – blind hole machining for medium and small batch production.

NEW TO THE RANGE

NEW ADDITION TO THE PRODUCT RANGE

- MF: M8 × 1–M18 × 1.5
- UNC: UNC6–UNC3/4 (DIN/ANSI)*

Dimension range:

- M: M3–M20

THE APPLICATION

- Primary applications:
ISO P: 350–1000 N/mm²,
ISO M: < 800 N/mm², ISO K: GJS (GGG)
- Secondary application:
ISO N: Aluminium wrought alloy,
AlSi < 4% silicon
- Up to 3 × D_N

THE TOOL

- Blind-hole tap
- WY80AA (HSS-E + TiN)
- WY80FC (HSS-E + vap)
- Tolerance ISO 2/6H/2B

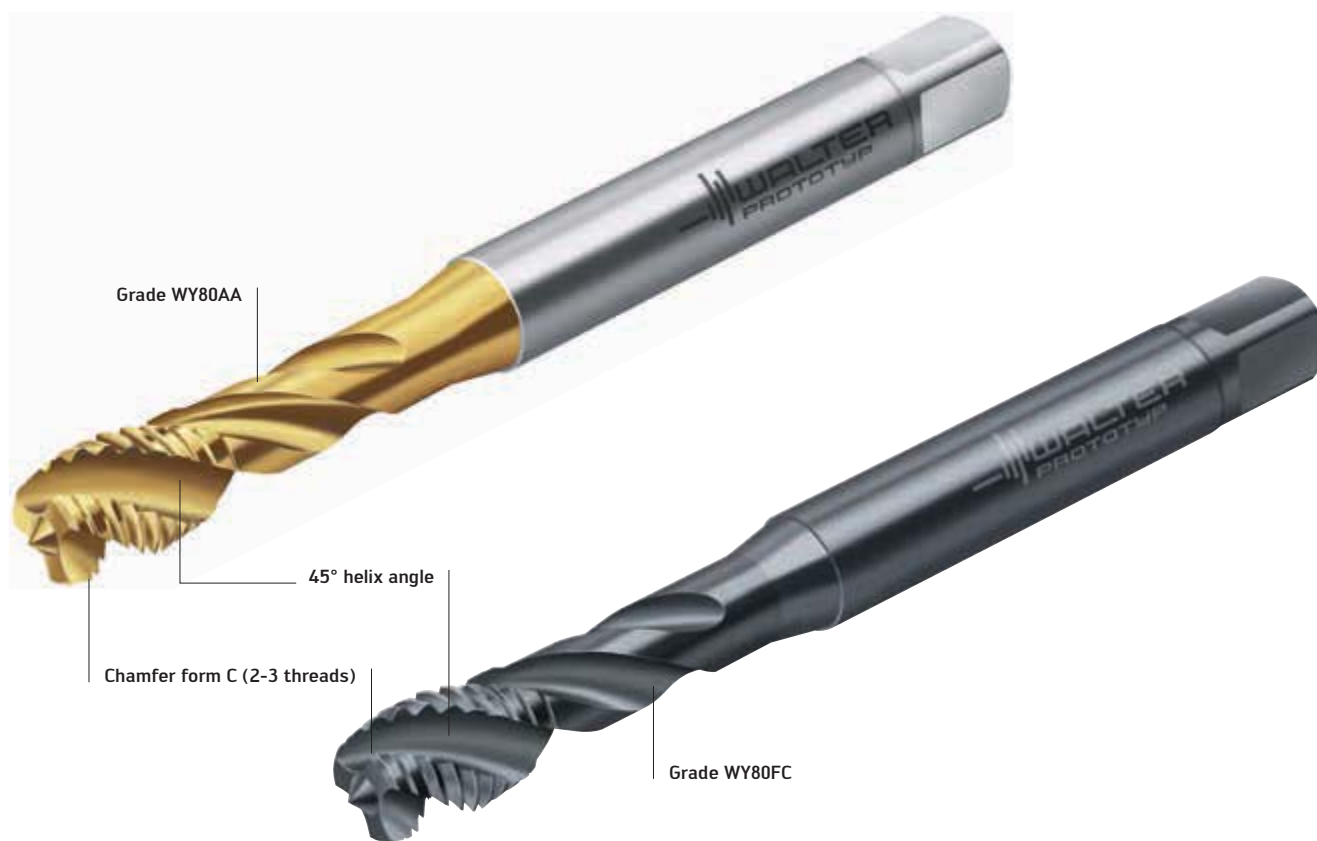

Walter Prototyp

Fig.: TC115 Perform

BENEFITS FOR YOU

- Cost-efficient machining of small and medium batch sizes
- Flexibility in blind hole machining thanks to a wide range of applications with a variety of materials
- TiN coating: Long tool life
- Vaporised: Very good chip control – minimises weld formation
- High process reliability

Ordering information from page 55.

* Overall length $\hat{=}$ DIN
Shank diameter $\hat{=}$ ANSI

TC216 Perform – through hole machining for medium and small batch production.

NEW TO THE RANGE

NEW ADDITION TO THE PRODUCT RANGE

- MF: M8 × 1–M18 × 1.5
- UNC: UNC6–UNC3/4 (DIN/ANSI)*

Dimension range:

- M: M3–M20

THE APPLICATION

- Primary applications:
 - ISO P: 350–1000 N/mm²,
 - ISO M: < 800 N/mm², ISO K: GJS (GGG),
 - ISO N: Al wrought alloy, AlSi < 4% silicon
- Up to 3.5 × D_N

THE TOOL

- Through-hole taps
- WY80AA (HSS-E + TiN)
- WY80FC (HSS-E + vap)
- Tolerance ISO 2/6H/2B



Walter Prototyp

Fig.: TC216 Perform

BENEFITS FOR YOU

- Cost-efficient machining of small and medium batch sizes
- Flexibility in through-hole machining thanks to a wide range of applications with a variety of materials
- TiN coating: Long tool life
- Vaporised: Very good chip control – minimises weld formation
- High process reliability

Ordering information from page 54.

* Overall length $\hat{=}$ DIN
Shank diameter $\hat{=}$ ANSI

HSS-E machine taps TC216 Perform



– For long-chipping materials

\leq
3xDN

B=3,5-5

32HRC
 1000
 -350
 N/mm²

MF

DIN 13

ISO2/6H

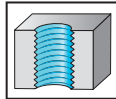

	P	M	K	N	S	H	O
WY80AA	●	●	●	●			
WY80FC	●	●	●	●			

DIN 374											WY80AA	WY80FC
Designation	D _N	P mm	l ₁ mm	L _c mm	l ₃ mm	d ₁ h9 mm	□ mm	l _g mm	N		WY80AA	WY80FC
TC216-M8X1-L0-	MF 8x1	1	90	18	67	6	4,9	8	3			
TC216-M10X1-L0-	MF 10x1	1	90	20	67	7	5,5	8	3			
TC216-M12X1.25-L0-	MF 12x1.25	1,25	100	21	73	9	7	10	4			
TC216-M12X1.5-L0-	MF 12x1.5	1,5	100	21	73	9	7	10	4			
TC216-M14X1.5-L0-	MF 14x1.5	1,5	100	21	71	11	9	12	4			
TC216-M16X1.5-L0-	MF 16x1.5	1,5	100	21	58	12	9	12	4			
TC216-M18X1.5-L0-	MF 18x1.5	1,5	110	24	66	14	11	14	4			

Ordering example for the WY80FC grade: TC216-M8X1-L0-WY80FC

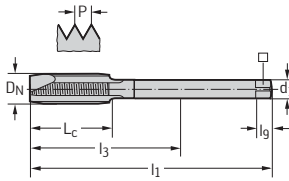

New addition to the product range

HSS-E machine taps TC115 Perform



– For long-chipping materials

≤
3×DN

C=2-3

45°

32HRC
1000
-350
N/mm²

MF
DIN 13

ISO2/6H

	P	M	K	N	S	H	O
WY80AA	●	●	●	●			
WY80FC	●	●	●	●			

DIN 374												WY80AA	WY80FC
Designation	D _N	P mm	l ₁ mm	L _c mm	l ₃ mm	d ₁ h9 mm	□ mm	l _g mm	N			WY80AA	WY80FC
TC115-M8X1-L0-	MF 8x1	1	90	12	67	6	4,9	8	3				
TC115-M10X1-L0-	MF 10x1	1	90	12	67	7	5,5	8	3				
TC115-M12X1.25-L0-	MF 12x1.25	1,25	100	13	73	9	7	10	4				
TC115-M12X1.5-L0-	MF 12x1.5	1,5	100	13	73	9	7	10	4				
TC115-M14X1.5-L0-	MF 14x1.5	1,5	100	15	71	11	9	12	4				
TC115-M16X1.5-L0-	MF 16x1.5	1,5	100	15	58	12	9	12	4				
TC115-M18X1.5-L0-	MF 18x1.5	1,5	110	17	66	14	11	14	4				

Ordering example for the WY80FC grade: TC115-M8X1-L0-WY80FC

WALTER SELECT

Best tool for

Good

Average

Poor

machining conditions

●● Primary application

● Other application

HSS-E machine taps TC216 Perform

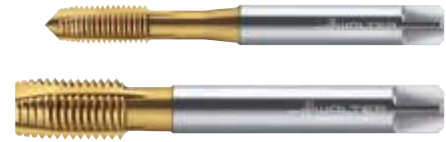

- For long-chipping materials

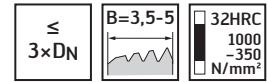

	P	M	K	N	S	H	O
WY80AA	●	●	●	●			

DIN/ANSI	Designation	D _N -P	D _N inches	l ₁ h9 inches	L _c inches	l ₃ inches	d ₁ inches	□ inches	l _g inches/ no.	N	WY80AA
	TC216DUNC6-C0-	UNC 6-32	0,138	2,205	0,433	0,787	0,141	0,110	3/16"	3	☞
	TC216DUNC8-C0-	UNC 8-32	0,164	2,480	0,472	0,827	0,168	0,131	1/4"	3	☞
	TC216DUNC10-C0-	UNC 10-24	0,190	2,756	0,512	0,984	0,194	0,152	1/4"	3	☞
	TC216DUNC1/4-C0-	UNC 1/4-20	0,250	3,150	0,591	1,181	0,255	0,191	5/16"	3	☞
	TC216DUNC5/16-C0-	UNC 5/16-18	0,313	3,543	0,709	1,378	0,318	0,238	3/8"	3	☞
	TC216DUNC3/8-C0-	UNC 3/8-16	0,375	3,937	0,787	1,535	0,381	0,286	7/16"	3	☞

DIN length/ANSI shank
Ordering example for the WY80AA grade: TC216DUNC6-C0-WY80AA

DIN/ANSI	Designation	D _N -P	D _N inches	l ₁ h9 inches	L _c inches	l ₃ inches	d ₁ inches	□ inches	l _g inches/ no.	N	WY80AA
	TC216DUNC1/2-L0-	UNC 1/2-13	0,500	4,331	0,906	3,224	0,367	0,275	7/16"	4	☞
	TC216DUNC5/8-L0-	UNC 5/8-11	0,625	4,331	0,984	2,587	0,480	0,360	9/16"	4	☞
	TC216DUNC3/4-L0-	UNC 3/4-10	0,750	4,921	1,181	3,051	0,590	0,442	11/16"	4	☞

DIN length/ANSI shank
Ordering example for the WY80AA grade: TC216DUNC1/2-L0-WY80AA

☞☞☞ New addition to the product range

HSS-E machine taps TC115 Perform



– For long-chipping materials

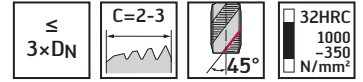
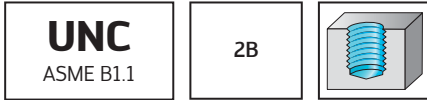

	P	M	K	N	S	H	O
WY80AA	●	●	●	●			

DIN/ANSI	Designation	D _N -P	D _N inches	l ₁ inches	L _c inches	l ₃ inches	d ₁ h9 inches	inches	l _g inches/ no.	N	WY80AA
	TC115DUNC6-C0-	UNC 6-32	0,138	2,205	0,256	0,787	0,141	0,110	3/16"	3	☘
	TC115DUNC8-C0-	UNC 8-32	0,164	2,480	0,276	0,827	0,168	0,131	1/4"	3	☘
	TC115DUNC10-C0-	UNC 10-24	0,190	2,756	0,315	0,984	0,194	0,152	1/4"	3	☘
	TC115DUNC1/4-C0-	UNC 1/4-20	0,250	3,150	0,394	1,181	0,255	0,191	5/16"	3	☘
	TC115DUNC5/16-C0-	UNC 5/16-18	0,313	3,543	0,472	1,378	0,318	0,238	3/8"	3	☘
	TC115DUNC3/8-C0-	UNC 3/8-16	0,375	3,937	0,591	1,535	0,381	0,286	7/16"	3	☘

DIN length/ANSI shank
Ordering example for the WY80AA grade: TC115DUNC6-C0-WY80AA

DIN/ANSI	Designation	D _N -P	D _N inches	l ₁ inches	L _c inches	l ₃ inches	d ₁ h9 inches	inches	l _g inches/ no.	N	WY80AA
	TC115DUNC1/2-L0-	UNC 1/2-13	0,500	4,331	0,709	3,224	0,367	0,275	7/16"	3	☘
	TC115DUNC5/8-L0-	UNC 5/8-11	0,625	4,331	0,787	2,587	0,480	0,360	9/16"	3	☘
	TC115DUNC3/4-L0-	UNC 3/4-10	0,750	4,921	0,984	3,051	0,590	0,442	11/16"	4	☘

DIN length/ANSI shank
Ordering example for the WY80AA grade: TC115DUNC1/2-L0-WY80AA

WALTER SELECT

Best tool for

Good

Average

Poor

machining conditions

●● Primary application

● Other application

MC341 Supreme – the new high-performance milling cutter specifically designed for machining steel.

NEW FOR 2016

THE TOOL

- Solid carbide high-performance milling cutters
- Diameter range 6–20 mm
- Helix angle $\lambda = 50^\circ$
- Reinforced core diameter
- Four cutting edges with differential pitch
- Reduced neck (d_2) and back cutting
- Shank DIN 6535 HA

THE APPLICATION

- Primary application: ISO P
- Secondary application: ISO M
- For roughing and finishing
- In cases where high machining volume is required
- Shoulder milling, full slotting, pocket milling, ramping, plunging and contour milling
- Usable for wet and dry machining
- Areas of use: General mechanical engineering, tool and mould making, and the automotive and energy industries

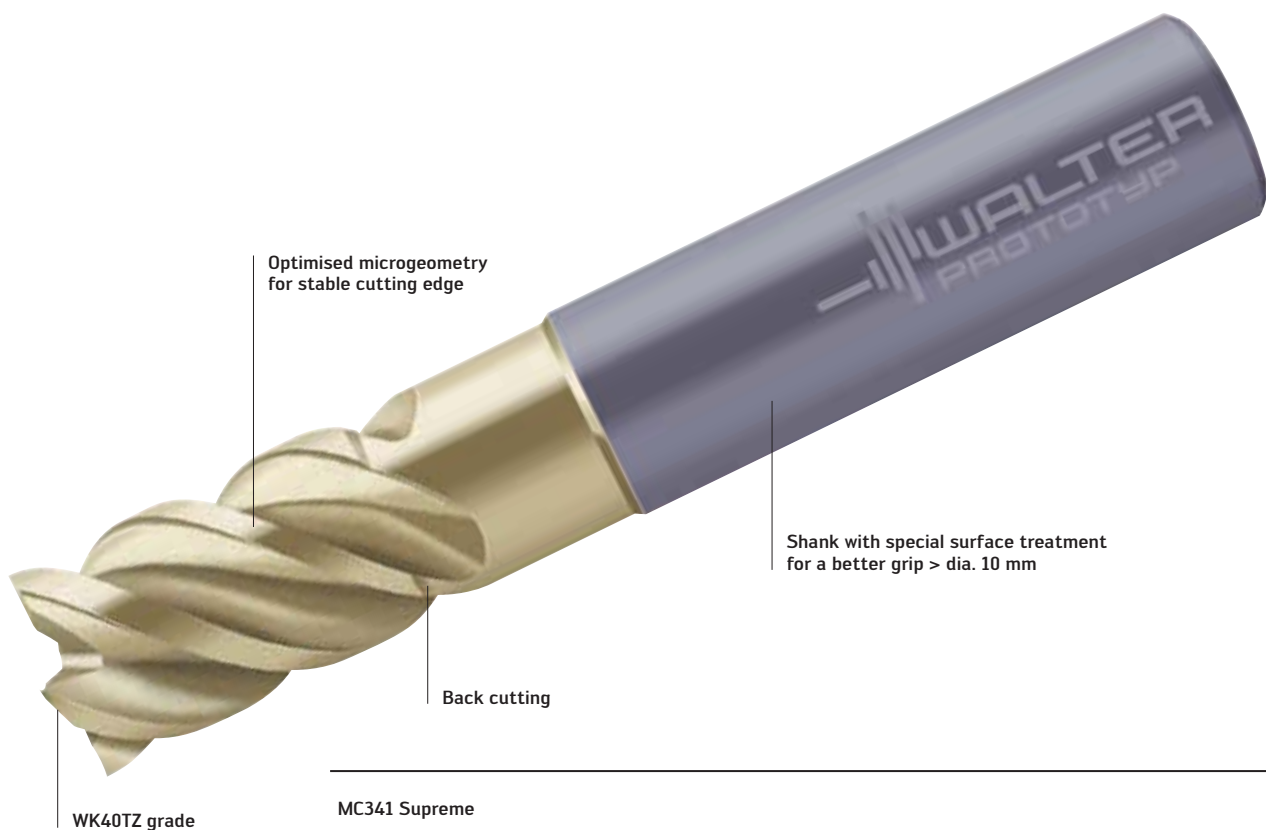

BENEFITS FOR YOU

- Exceptional tool life and performance increases of up to 50% thanks to the innovative new Walter WK40TZ grade as well as a special coating process
- Full slotting in steel materials (up to $1.5 \times D_c$)
- Low spindle load thanks to differential pitch
- Soft cutting action and optimal chip evacuation
- Back cutting reduces transitions when performing side face machining
- High level of process reliability due to stable core and optimised microgeometry

Ordering information
from page 63.

THE COATING

- Smooth and homogeneous surface
- High layer hardness and e-module

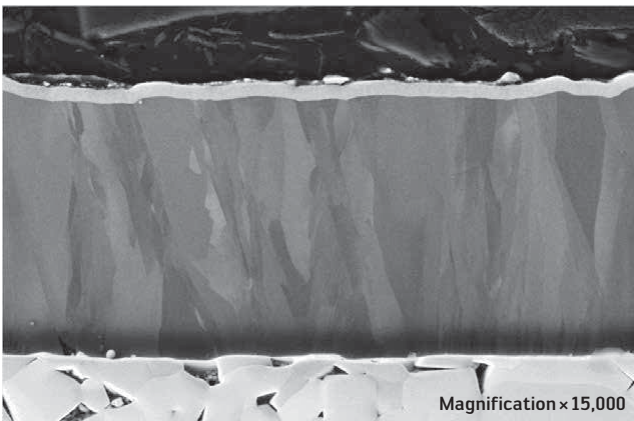

WK40TZ grinding pattern optimised for coating efficiency and tool life

APPLICATION EXAMPLE

Gearbox housing cover

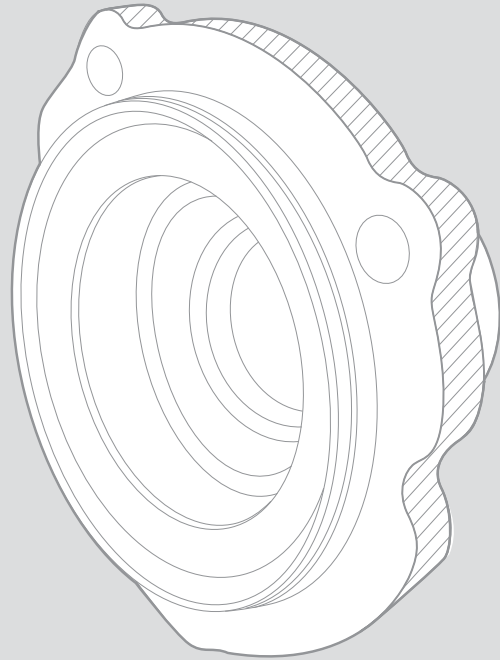

Material: 100Cr6
Tool: MC341-16.0A4P-WK40TZ
Cooling: 5% emulsion, external

Cutting data:

	Existing	MC341
a_e	16 mm	16 mm
a_p	11 mm	11 mm
	Full slot milling	Full slot milling
v_c	103 m/min	150 m/min
n	2049 rpm	2849 rpm
f_z	0.09 mm	0.09 mm
v_f	740 mm/min	1.025 mm/min

Comparison: Tool life [m]

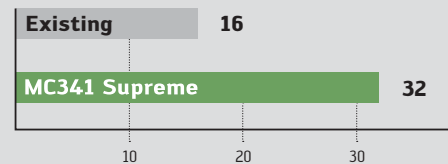

+100 %

Watch product animation:
 Scan this QR code or go directly
 to <http://goo.gl/vyJpg4>



The Walter Advance line of milling cutters – setting the standard for higher tool life.

NEW FOR 2016

NEW ADDITION TO THE PRODUCT RANGE



MC122 Advance shoulder milling cutter
45° helix angle



MC129 Advance shoulder milling cutter
60° helix angle



MC321 Advance shoulder/slot milling cutter
45° helix angle



MC324 Advance shoulder/slot milling cutter
45° helix angle



MC413 Advance ball-nose end mill
30° helix angle



MC416 Advance ball nose end mill
30° helix angle



MC500 Advance chamfer milling cutter
60° helix angle



MC501 Advance chamfer milling cutter
90° helix angle



MC502 Advance chamfer milling cutter
120° helix angle



MC503 Advance quarter-round profile milling cutter



MC504 Advance front & back chamfer/deburr



MC716 Advance routing milling cutter
30° helix angle

Walter Prototyp Advance line

Fig.: New milling cutter types

Custom geometries

WJ30TF grade

Up to **50%**
increase in tool life

THE APPLICATION

- Universal application in ISO P, M, K and S
- Shoulder milling, full slotting, pocket milling, ramping, plunging and drilling
- Copy milling of shapes and flank faces
- Profile milling of chamfers and radii
- Areas of use: General mechanical engineering, tool and mould making, the automotive and energy industries, medical technology and the aerospace industry

THE TOOLS

- 12 cutter types with 252 dimension variations
- Diameter range 1–20 mm
- Different geometry versions
- Available in various lengths

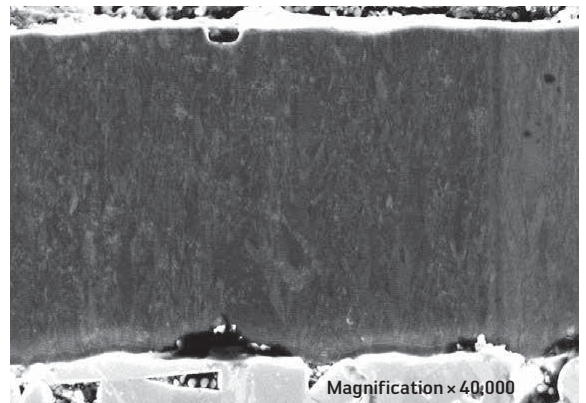

WJ30TF optimised grinding pattern



Watch product animation:
Scan this QR code or go directly
to <http://goo.gl/hdLw5k>

Ordering information
from page 69.

BENEFITS FOR YOU

- Particularly suitable for series production with medium batch sizes (more information regarding the advantages of the Walter Advance line is available on p. 110)
- Long tool life thanks to the high-performance WJ30TF grade
- Low inventory costs thanks to the broad spectrum of applications

An essential component of the WJ30TF grade is the newly developed coating with a nano laminated structure. It prevents any cracks from forming and provides a perfect balance of hardness and toughness.

Proto-max™_{ST} with Z5: More benefits in terms of metal removal rate – even on smaller diameters.

NEW TO THE RANGE

NEW ADDITIONS TO THE PRODUCT RANGE

- Small dimensions: 6–10 mm diameter with and without corner radius

THE APPLICATION

- Primary application: ISO P
- Secondary application: ISO M
- For dynamic or trochoidal milling, for roughing and finishing
- In applications where high machining volume is required
- Shoulder milling, full slotting, helical plunging, pocket milling, ramping and contour milling
- For wet and dry machining
- Areas of use: General mechanical engineering, the energy and automotive industries, and tool and mould making

THE TOOLS

- Solid carbide high-performance milling cutters
- With and without corner radius ($R = 0.5\text{--}4\text{ mm}$)
- Diameter range 6–25 mm
- 35° helix angle
- 5 cutting edges
- Shank DIN 6535 HB

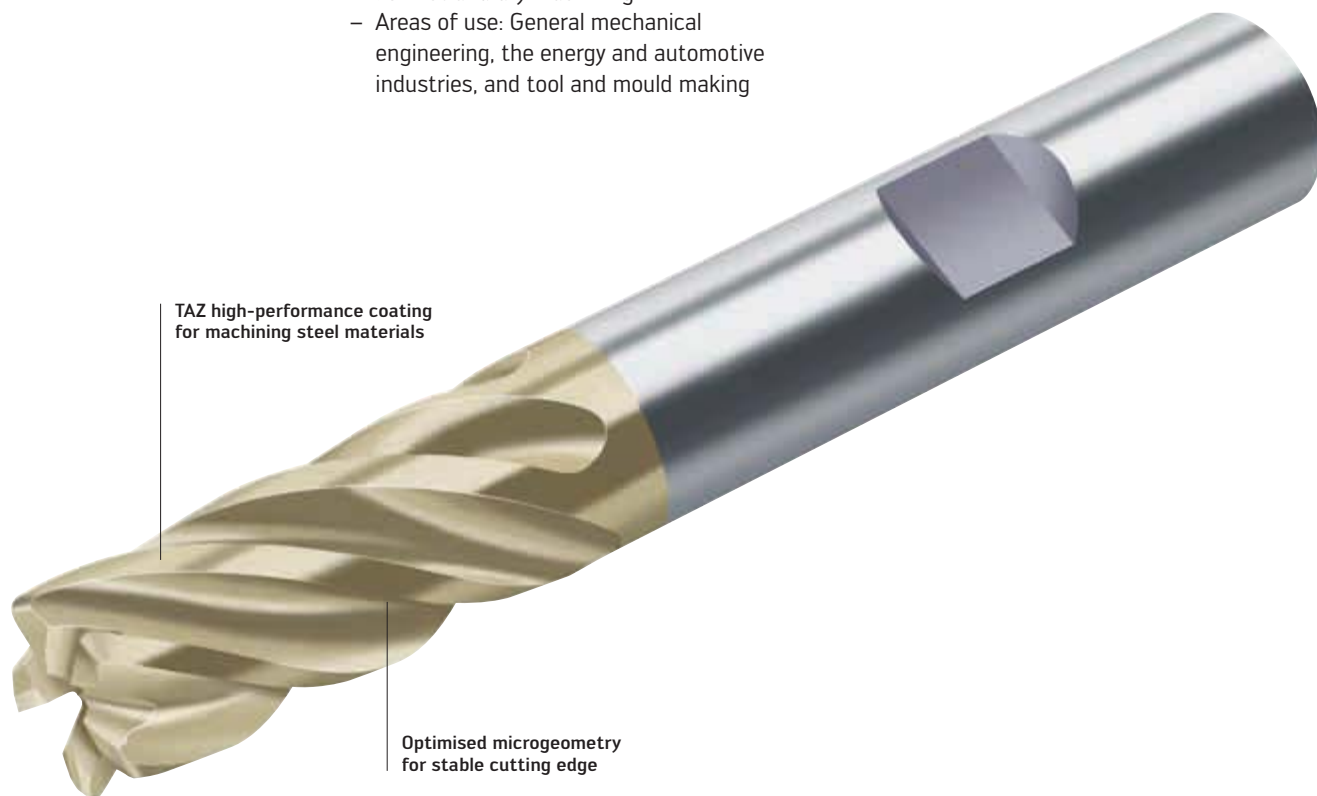

Proto-max™_{ST} high-performance milling cutter

Fig.: H4137217

BENEFITS FOR YOU

- Maximum metal removal rate: Up to 50% more than four-fluted tools typically found on the market
- High process reliability and productivity for dynamic milling processes
- High tool life thanks to the TAZ coating

Solid carbide shoulder/slot milling cutter MC341 Supreme

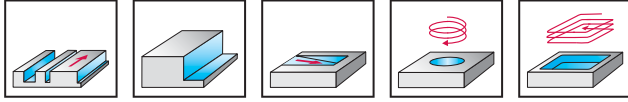

Z = 4

55HRC

P	M	K	N	S	H	O
●	●					

P standard		D_c h9 mm	L_c mm	l_3 mm	d_2 mm	l_1 mm	l_4 mm	d_1 h6 mm	Z	WK40TZ
Shank DIN 6535 HA 	Designation									
	MC341-06.0A4P-	6	10	16	5,5	57	21	6	4	☺
	MC341-08.0A4P-	8	13	22	7,6	63	27	8	4	☺
	MC341-10.0A4P-	10	16	28	9,5	72	32	10	4	☺
	MC341-12.0A4P-	12	19	33	11,4	83	38	12	4	☺
	MC341-16.0A4P-	16	26	42	15,2	92	44	16	4	☺
MC341-20.0A4P-	20	32	52	19	104	54	20	4	☺	

Slot milling $a_p \leq 1.5 \times D_c$
 Shoulder milling $a_e \leq 0.5 \times D_c$
 Ordering example for the WK40TZ grade: MC341-06.0A4P-WK40TZ

Solid carbide shoulder/slot milling cutter

H4135217 / H4137217

Proto-max™_{ST}

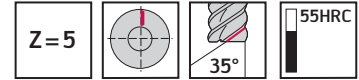
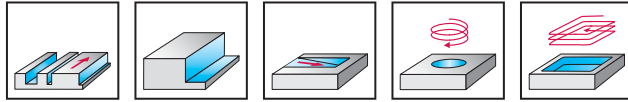

DIN 6527 L	TAZ designation	D _c h9 mm	L _c mm	l ₁ mm	l ₄ mm	d ₁ h5 mm	Z
Shank DIN 6535 HB 	★ H4135217-6	6	13	57	21	6	5
	★ H4135217-8	8	19	63	27	8	5
	★ H4135217-10	10	22	72	32	10	5
	H4135217-12	12	26	83	38	12	5
	H4135217-16	16	32	92	44	16	5
	H4135217-20	20	38	104	54	20	5
	H4135217-25	25	45	121	65	25	5

Slot milling $a_p \leq 1.0 \times D_c$
Shoulder milling $a_e \leq 0.6 \times D_c$

DIN 6527 L	TAZ designation	D _c h9 mm	R mm	L _c mm	l ₁ mm	l ₄ mm	d ₁ h5 mm	Z
Shank DIN 6535 HB 	★ H4137217-6-0.5	6	0.5	13	57	21	6	5
	★ H4137217-6-1	6	1	13	57	21	6	5
	★ H4137217-8-0.5	8	0.5	19	63	27	8	5
	★ H4137217-8-1	8	1	19	63	27	8	5
	★ H4137217-8-2	8	2	19	63	27	8	5
	★ H4137217-10-0.5	10	0.5	22	72	32	10	5
	★ H4137217-10-1	10	1	22	72	32	10	5
	★ H4137217-10-2	10	2	22	72	32	10	5
	H4137217-12-0.5	12	0.5	26	83	38	12	5
	H4137217-12-1	12	1	26	83	38	12	5
	H4137217-12-2	12	2	26	83	38	12	5
	H4137217-16-0.5	16	0.5	32	92	44	16	5
	H4137217-16-1	16	1	32	92	44	16	5
	H4137217-16-2	16	2	32	92	44	16	5
	H4137217-20-1	20	1	38	104	54	20	5
	H4137217-20-2	20	2	38	104	54	20	5
	H4137217-20-4	20	4	38	104	54	20	5
	H4137217-25-1	25	1	45	121	65	25	5
	H4137217-25-2	25	2	45	121	65	25	5
	H4137217-25-4	25	4	45	121	65	25	5

Slot milling $a_p \leq 1.0 \times D_c$
Shoulder milling $a_e \leq 0.6 \times D_c$

★ New addition to the product range

☺ ☹ ☹ New addition to the product range

Solid carbide shoulder/slot milling cutter MC326 Supreme



- Type N 50

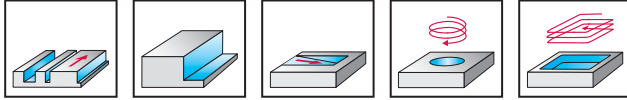

Z= 3-4

50°

48HRC

P	M	K	N	S	H	O
●	●	●	●	●		

WK40TF

P standard L		D _c h10 mm	L _c mm	l ₃ mm	l ₁ mm	l ₄ mm	d ₁ h5 mm	Z	WK40TF
Shank DIN 6535 HA									
	MC326-02.0A3L-	2	7	7	57	21	6	3	☺
	MC326-02.5A3L-	2,5	8	8	57	21	6	3	☺
	MC326-03.0A3L-	3	8	8	57	21	6	3	☺
	MC326-03.5A3L-	3,5	10	10	57	21	6	3	☺
	MC326-04.0A3L-	4	11	11	57	21	6	3	☺
	MC326-04.5A3L-	4,5	11	11	57	21	6	3	☺
	MC326-05.0A3L-	5	13	13	57	21	6	3	☺
	MC326-06.0A4L-	6	13	13	65	29	6	4	☺
	MC326-07.0A4L-	7	16	16	80	44	8	4	☺
	MC326-08.0A4L-	8	19	19	80	44	8	4	☺
	MC326-09.0A4L-	9	19	19	100	60	10	4	☺
	MC326-10.0A4L-	10	22	22	100	60	10	4	☺
	MC326-11.0A4L-	11	26	26	100	55	12	4	☺
	MC326-12.0A4L-	12	26	26	100	55	12	4	☺
	MC326-14.0A4L-	14	26	26	104	59	14	4	☺
	MC326-16.0A4L-	16	32	32	115	67	16	4	☺
MC326-20.0A4L-	20	38	38	125	75	20	4	☺	

Slot milling $a_p \leq 0.9 \times D_c$

Shoulder milling $a_e \leq 0.3 \times D_c$

Ordering example for the WK40TF grade: MC326-02.0A3L-WK40TF

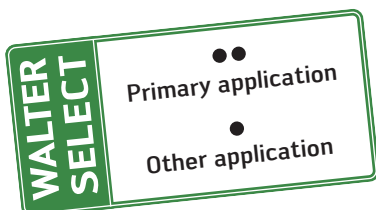

Solid carbide shoulder/slot milling cutter MC326 Supreme



– Type N 50

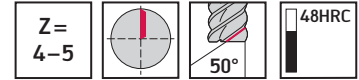
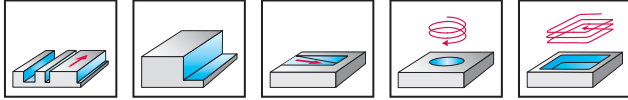

P	M	K	N	S	H	O
●	●	●	●	●	●	●

WK40TF

DIN 6527 L		D_c h10 mm	L_c mm	l_1 mm	l_4 mm	d_1 h5 mm	Z	WK40TF
Shank DIN 6535 HA	MC326-06.0A4B-	6	13	57	21	6	4	☺
	MC326-08.0A4B-	8	19	63	27	8	4	☺
	MC326-10.0A4B-	10	22	72	32	10	4	☺
	MC326-12.0A4B-	12	26	83	38	12	4	☺
	MC326-14.0A4B-	14	26	83	38	14	4	☺
	MC326-16.0A4B-	16	32	92	44	16	4	☺
	MC326-18.0A4B-	18	32	92	44	18	4	☺
	MC326-20.0A4B-	20	38	104	54	20	4	☺
	MC326-25.0A5B-	25	45	121	65	25	5	☺
Shank DIN 6535 HB	MC326-06.0W4B-	6	13	57	21	6	4	☺
	MC326-08.0W4B-	8	19	63	27	8	4	☺
	MC326-10.0W4B-	10	22	72	32	10	4	☺
	MC326-12.0W4B-	12	26	83	38	12	4	☺
	MC326-14.0W4B-	14	26	83	38	14	4	☺
	MC326-16.0W4B-	16	32	92	44	16	4	☺
	MC326-18.0W4B-	18	32	92	44	18	4	☺
	MC326-20.0W4B-	20	38	104	54	20	4	☺
	MC326-25.0W5B-	25	45	121	65	25	5	☺

 Slot milling $a_p \leq 0.9 \times D_c$

 Shoulder milling $a_e \leq 0.3 \times D_c$

Ordering example for the WK40TF grade: MC326-06.0A4B-WK40TF

New addition to the product range

Solid carbide shoulder/slot milling cutter MC326 Supreme



- Long reach
- Type N 50

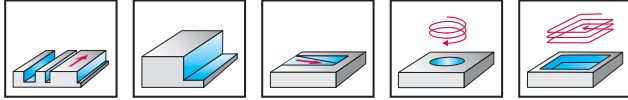

Z = 4

P	M	K	N	S	H	O
●●	●	●	●	●	●	●

DIN 6527 L		D_c h10 mm	L_c mm	l_3 mm	d_2 mm	l_1 mm	l_4 mm	d_1 h5 mm	Z	WK40TF
	Designation									
	Shank DIN 6535 HB									
	MC326-06.0W4BC-	6	13	19	5,7	57	21	6	4	☺
	MC326-08.0W4BC-	8	19	25	7,6	63	27	8	4	☺
	MC326-10.0W4BC-	10	22	30	9,5	72	32	10	4	☺
	MC326-12.0W4BC-	12	26	36	11,4	83	38	12	4	☺
	MC326-14.0W4BC-	14	26	36	13,3	83	38	14	4	☺
MC326-16.0W4BC-	16	32	42	15,2	92	44	16	4	☺	
MC326-20.0W4BC-	20	38	52	19	104	54	20	4	☺	

Slot milling $a_p \leq 0.9 \times D_c$
 Shoulder milling $a_e \leq 0.3 \times D_c$
 Ordering example for the WK40TF grade: MC326-06.0W4BC-WK40TF

WALTER SELECT

Best tool for

☺
Good

☹
Average

☹
Poor

machining conditions

●● Primary application

● Other application

Solid carbide shoulder/slot milling cutter MC326 Supreme



- Long reach
- Type N 50 long

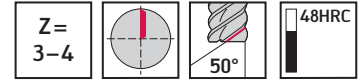
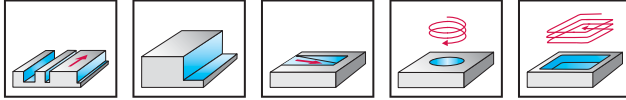

	P	M	K	N	S	H	O
WK40TF	●	●	●	●	●		

P standard L

	Designation	D _c h10 mm	L _c mm	l ₃ mm	d ₂ mm	l ₁ mm	l ₄ mm	d ₁ h5 mm	Z	WK40TF
	Shank DIN 6535 HB									
	MC326-04.0W3LC-	4	11	15	3,8	57	21	6	3	⊕
	MC326-05.0W3LC-	5	13	16	4,75	57	21	6	3	⊕
	MC326-06.0W4LC-	6	13	27	5,7	65	29	6	4	⊕
	MC326-08.0W4LC-	8	19	42	7,6	80	44	8	4	⊕
	MC326-10.0W4LC-	10	22	58	9,5	100	60	10	4	⊕
	MC326-12.0W4LC-	12	26	53	11,4	100	55	12	4	⊕
	MC326-14.0W4LC-	14	26	57	13,3	104	59	14	4	⊕
	MC326-16.0W4LC-	16	32	65	15,2	115	67	16	4	⊕
	MC326-20.0W4LC-	20	38	73	19	125	75	20	4	⊕

Slot milling $a_p \leq 0.9 \times D_c$

Shoulder milling $a_e \leq 0.3 \times D_c$

Ordering example for the WK40TF grade: MC326-04.0W3LC-WK40TF

Solid carbide shoulder/slot milling cutter MC326 Supreme



- Long reach
- Type N 50

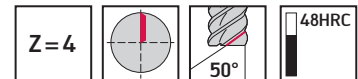
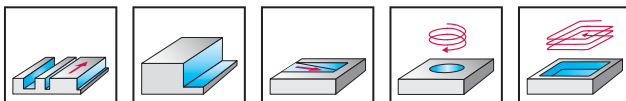

	P	M	K	N	S	H	O
WK40TF	●	●	●	●	●		

DIN 6527 L

	Designation	D _c h10 mm	L _c mm	l ₃ mm	d ₂ mm	l ₁ mm	l ₄ mm	d ₁ h5 mm	Z	WK40TF
	Shank DIN 6535 HB									
	MC326-06.0W4BCJ-	6	6	19	5,7	57	21	6	4	⊕
	MC326-08.0W4BCJ-	8	8	25	7,6	63	27	8	4	⊕
	MC326-10.0W4BCJ-	10	10	30	9,5	72	32	10	4	⊕
	MC326-12.0W4BCJ-	12	12	36	11,4	83	38	12	4	⊕
	MC326-14.0W4BCJ-	14	14	36	13,3	83	38	14	4	⊕
	MC326-16.0W4BCJ-	16	16	42	15,2	92	44	16	4	⊕

Slot milling $a_p \leq 0.9 \times D_c$

Shoulder milling $a_e \leq 0.3 \times D_c$

Ordering example for the WK40TF grade: MC326-06.0W4BCJ-WK40TF

⊕ ⊕ ⊕ New addition to the product range

Solid carbide shoulder/slot milling cutter MC321 Advance



- Type N 45

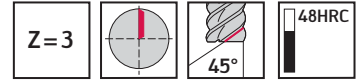
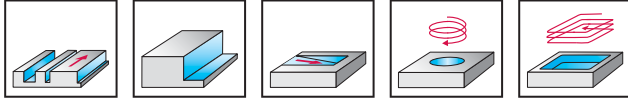

DIN 6527 K		D_c h11 mm	L_c mm	l_1 mm	l_4 mm	d_1 h6 mm	Z	WJ30TF
Shank DIN 6535 HA	MC321-02.0A3A-	2	6	50	14	6	3	●●●
	MC321-03.0A3A-	3	7	50	14	6	3	●●●
	MC321-04.0A3A-	4	8	54	18	6	3	●●●
	MC321-05.0A3A-	5	10	54	18	6	3	●●●
	MC321-06.0A3A-	6	10	54	18	6	3	●●●
	MC321-08.0A3A-	8	16	58	22	8	3	●●●
	MC321-10.0A3A-	10	19	66	26	10	3	●●●
	MC321-12.0A3A-	12	22	73	28	12	3	●●●

Slot milling $a_p \leq 0.5 \times D_c$
Shoulder milling $a_e \leq 0.6 \times D_c$
Ordering example for the WJ30TF grade: MC321-02.0A3A-WJ30TF

P standard S		D_c h11 mm	L_c mm	l_1 mm	l_4 mm	d_1 h6 mm	Z	WJ30TF
Shank DIN 6535 HA	MC321-02.0A3S-	2	3	39	8	6	3	●●●
	MC321-03.0A3S-	3	4	39	9	6	3	●●●
	MC321-04.0A3S-	4	5	39	11	6	3	●●●
	MC321-05.0A3S-	5	6	39	12	6	3	●●●
	MC321-06.0A3S-	6	7	39	12	6	3	●●●
	MC321-08.0A3S-	8	9	44	17	8	3	●●●
	MC321-10.0A3S-	10	11	51	20	10	3	●●●
	MC321-12.0A3S-	12	13	56	22	12	3	●●●

Slot milling $a_p \leq 0.5 \times D_c$
Shoulder milling $a_e \leq 0.6 \times D_c$
Ordering example for the WJ30TF grade: MC321-02.0A3S-WJ30TF

WALTER SELECT

Best tool for

Good

Average

Poor

machining conditions

●● Primary application

● Other application

Solid carbide shoulder/slot milling cutter

MC321 Advance / MC321 Advance inch



– Type N 45

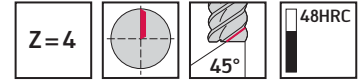
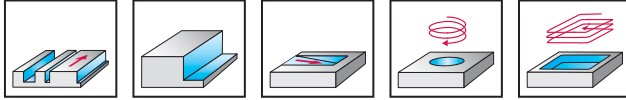

WJ30TF	P	M	K	N	S	H	O
	●	●	●	●	●		

DIN 6527 K	Designation	D _c h11 mm	L _c mm	l ₁ mm	l ₄ mm	d ₁ h6 mm	Z	WJ30TF
	Shank DIN 6535 HA							
	MC321-02.0A4A-	2	6	50	14	6	4	🔴
	MC321-03.0A4A-	3	7	50	14	6	4	🔴
	MC321-04.0A4A-	4	8	54	18	6	4	🔴
	MC321-05.0A4A-	5	10	54	18	6	4	🔴
	MC321-06.0A4A-	6	10	54	18	6	4	🔴
	MC321-08.0A4A-	8	16	58	22	8	4	🔴
	MC321-10.0A4A-	10	19	66	26	10	4	🔴
	MC321-12.0A4A-	12	22	73	28	12	4	🔴

 Slot milling $a_p \leq 0.5 \times D_c$

 Shoulder milling $a_e \leq 0.6 \times D_c$

Ordering example for the WJ30TF grade: MC321-02.0A4A-WJ30TF

P standard S	Designation	D _c h11 mm	L _c mm	l ₁ mm	l ₄ mm	d ₁ h6 mm	Z	WJ30TF
	Shank DIN 6535 HA							
	MC321-02.0A4S-	2	3	39	8	6	4	🔴
	MC321-03.0A4S-	3	4	39	9	6	4	🔴
	MC321-04.0A4S-	4	5	39	11	6	4	🔴
	MC321-05.0A4S-	5	6	39	12	6	4	🔴
	MC321-06.0A4S-	6	7	39	12	6	4	🔴
	MC321-08.0A4S-	8	9	44	17	8	4	🔴
	MC321-10.0A4S-	10	11	51	20	10	4	🔴
	MC321-12.0A4S-	12	13	56	22	12	4	🔴

 Slot milling $a_p \leq 0.5 \times D_c$

 Shoulder milling $a_e \leq 0.6 \times D_c$

Ordering example for the WJ30TF grade: MC321-02.0A4S-WJ30TF

Tool	Designation	D _c h11 inches/no.	L _c inches	l ₁ inches	l ₄ inches	d ₁ h6 inches/no.	Z	WJ30TF
	MC321.3.18A4C-	1/8"	0,250	2,500	1,083	1/4"	4	🔴
	MC321.4.75A4C-	3/16"	0,375	2,500	1,083	1/4"	4	🔴
	MC321.6.35A4C-	1/4"	0,500	2,500	1,083	1/4"	4	🔴
	MC321.7.94A4C-	5/16"	0,500	2,500	0,937	3/8"	4	🔴
	MC321.9.53A4C-	3/8"	0,563	2,500	0,937	3/8"	4	🔴
	MC321.11.1A4C-	7/16"	0,625	3,000	1,217	1/2"	4	🔴
	MC321.12.7A4C-	1/2"	0,625	3,000	1,217	1/2"	4	🔴

 Slot milling $a_p \leq 0.5 \times D_c$

 Shoulder milling $a_e \leq 0.6 \times D_c$

Ordering example for the WJ30TF grade: MC321.11.1A4C-WJ30TF

New addition to the product range

Solid carbide shoulder/slot milling cutter MC324 Advance



- Type 45

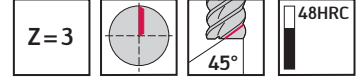
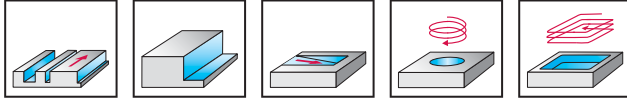

DIN 6527 L		D_c h10 mm	L_c mm	l_1 mm	l_4 mm	d_1 h6 mm	Z	WJ30TF
Shank DIN 6535 HA	MC324-01.0A3B-	1	3	57	21	6	3	
	MC324-01.5A3B-	1,5	3	57	21	6	3	
	MC324-02.0A3B-	2	6	57	21	6	3	
	MC324-02.5A3B-	2,5	7	57	21	6	3	
	MC324-03.0A3B-	3	7	57	21	6	3	
	MC324-03.5A3B-	3,5	7	57	21	6	3	
	MC324-04.0A3B-	4	8	57	21	6	3	
	MC324-04.5A3B-	4,5	8	57	21	6	3	
	MC324-05.0A3B-	5	10	57	21	6	3	
	MC324-05.5A3B-	5,5	10	57	21	6	3	
	MC324-06.0A3B-	6	10	57	21	6	3	
	MC324-07.0A3B-	7	13	63	27	8	3	
	MC324-08.0A3B-	8	16	63	27	8	3	
	MC324-09.0A3B-	9	16	72	32	10	3	
	MC324-10.0A3B-	10	19	72	32	10	3	
	MC324-12.0A3B-	12	22	83	38	12	3	
	MC324-14.0A3B-	14	22	83	38	14	3	
	MC324-16.0A3B-	16	26	92	44	16	3	
	MC324-18.0A3B-	18	26	92	44	18	3	
	MC324-20.0A3B-	20	32	104	54	20	3	
Shank DIN 6535 HB	MC324-01.0W3B-	1	3	57	21	6	3	
	MC324-01.5W3B-	1,5	3	57	21	6	3	
	MC324-02.0W3B-	2	6	57	21	6	3	
	MC324-02.5W3B-	2,5	7	57	21	6	3	
	MC324-03.0W3B-	3	7	57	21	6	3	
	MC324-03.5W3B-	3,5	7	57	21	6	3	
	MC324-04.0W3B-	4	8	57	21	6	3	
	MC324-04.5W3B-	4,5	8	57	21	6	3	
	MC324-05.0W3B-	5	10	57	21	6	3	
	MC324-05.5W3B-	5,5	10	57	21	6	3	
	MC324-06.0W3B-	6	10	57	21	6	3	
	MC324-08.0W3B-	8	16	63	27	8	3	
	MC324-09.0W3B-	9	16	72	32	10	3	
	MC324-10.0W3B-	10	19	72	32	10	3	
	MC324-12.0W3B-	12	22	83	38	12	3	
	MC324-14.0W3B-	14	22	83	38	14	3	
	MC324-16.0W3B-	16	26	92	44	16	3	
	MC324-20.0W3B-	20	32	104	54	20	3	

Slot milling $a_p \leq 0.5 \times D_c$

Shoulder milling $a_e \leq 0.6 \times D_c$

Ordering example for the WJ30TF grade: MC324-01.0A3B-WJ30TF

Solid carbide shoulder/slot milling cutter MC324 Advance



- Type 45

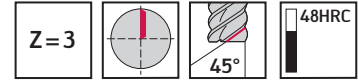
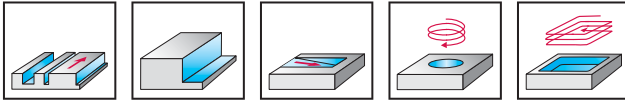

	P	M	K	N	S	H	O
WJ30TF	●	●	●	●	●		

DIN 6527 L		D_c h9 mm	R mm	L_c mm	l_3 mm	d_2 mm	l_1 mm	l_4 mm	d_1 h6 mm	Z	WJ30TF
Shank DIN 6535 HB	MC324-12.0W3B150C-	12	1,5	22	36	11,4	83	38	12	3	15
	MC324-14.0W3B150C-	14	1,5	22	36	13,3	83	38	14	3	15
	MC324-16.0W3B200C-	16	2	26	42	15,2	92	44	16	3	15
	MC324-18.0W3B200C-	18	2	26	42	17,1	92	44	18	3	15
	MC324-20.0W3B200C-	20	2	32	52	19	104	54	20	3	15

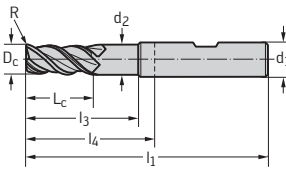

Ordering example for the WJ30TF grade: MC324-12.0W3B150C-WJ30TF

New addition to the product range

Solid carbide routing cutters

MC716 Advance



- Type 30

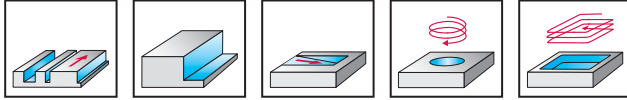

Z = 2

WJ30TF

P	M	K	N	S	H	O
●	●	●	●	●		

DIN 6527 K		D _c e8 mm	l ₁₁ mm	L _c mm	l ₁ mm	l ₄ mm	d ₁ h6 mm	Z	WJ30TF
Shank DIN 6535 HB									
	MC716-02.0W2A-	2	0,1	3	50	14	6	2	●
	MC716-02.5W2A-	2,5	0,1	3	50	14	6	2	●
	MC716-02.8W2A-	2,8	0,1	4	50	14	6	2	●
	MC716-03.0W2A-	3	0,1	4	50	14	6	2	●
	MC716-03.5W2A-	3,5	0,1	4	50	14	6	2	●
	MC716-03.8W2A-	3,8	0,1	5	54	18	6	2	●
	MC716-04.0W2A-	4	0,1	5	54	18	6	2	●
	MC716-04.8W2A-	4,8	0,1	6	54	18	6	2	●
	MC716-05.0W2A-	5	0,1	6	54	18	6	2	●
	MC716-05.75W2A-	5,75	0,1	7	54	18	6	2	●
	MC716-06.0W2A-	6	0,1	7	54	18	6	2	●
	MC716-07.75W2A-	7,75	0,1	9	58	22	8	2	●
	MC716-08.0W2A-	8	0,1	9	58	22	8	2	●
	MC716-09.0W2A-	9	0,2	10	66	26	10	2	●
	MC716-09.7W2A-	9,7	0,2	11	66	26	10	2	●
	MC716-10.0W2A-	10	0,2	11	66	26	10	2	●
	MC716-11.7W2A-	11,7	0,2	12	73	28	12	2	●
	MC716-12.0W2A-	12	0,2	12	73	28	12	2	●
	MC716-13.7W2A-	13,7	0,2	14	75	30	14	2	●
	MC716-15.7W2A-	15,7	0,2	16	82	34	16	2	●
	MC716-16.0W2A-	16	0,2	16	82	34	16	2	●
	MC716-20.0W2A-	20	0,3	20	92	42	20	2	●

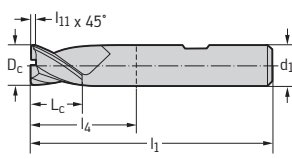

Slot milling $a_p \leq 0.5 \times D_c$
 Shoulder milling $a_e \leq 0.6 \times D_c$
 Ordering example for the WJ30TF grade: MC716-02.0W2A-WJ30TF

WALTER SELECT

Best tool for machining conditions

Good
 Average
 Poor

● Primary application
 ● Other application

Solid carbide routing cutters

MC716 Advance



- Type 30

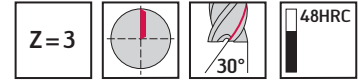
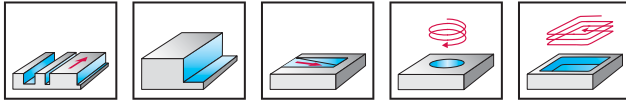

DIN 6527 K		D_c h10 mm	l_{11} mm	L_c mm	l_1 mm	l_4 mm	d_1 h6 mm	Z	WJ30TF
Shank DIN 6535 HB									
	MC716-01.8W3A-	1,8	0,1	3	50	14	6	3	
	MC716-02.0W3A-	2	0,1	3	50	14	6	3	
	MC716-02.5W3A-	2,5	0,1	3	50	14	6	3	
	MC716-02.8W3A-	2,8	0,1	4	50	14	6	3	
	MC716-03.0W3A-	3	0,1	4	50	14	6	3	
	MC716-03.5W3A-	3,5	0,1	4	50	14	6	3	
	MC716-03.8W3A-	3,8	0,1	5	54	18	6	3	
	MC716-04.0W3A-	4	0,1	5	54	18	6	3	
	MC716-04.8W3A-	4,8	0,1	6	54	18	6	3	
	MC716-05.0W3A-	5	0,1	6	54	18	6	3	
	MC716-05.75W3A-	5,75	0,1	7	54	18	6	3	
	MC716-06.0W3A-	6	0,1	7	54	18	6	3	
	MC716-06.75W3A-	6,75	0,1	8	58	22	8	3	
	MC716-07.0W3A-	7	0,1	8	58	22	8	3	
	MC716-07.75W3A-	7,75	0,1	9	58	22	8	3	
	MC716-08.0W3A-	8	0,1	9	58	22	8	3	
	MC716-09.0W3A-	9	0,2	10	66	26	10	3	
	MC716-09.7W3A-	9,7	0,2	11	66	26	10	3	
	MC716-10.0W3A-	10	0,2	11	66	26	10	3	
	MC716-11.7W3A-	11,7	0,2	12	73	28	12	3	
	MC716-12.0W3A-	12	0,2	12	73	28	12	3	
	MC716-13.7W3A-	13,7	0,2	14	75	30	14	3	
	MC716-14.0W3A-	14	0,2	14	75	30	14	3	
	MC716-15.7W3A-	15,7	0,2	16	82	34	16	3	
	MC716-16.0W3A-	16	0,2	16	82	34	16	3	
	MC716-17.7W3A-	17,7	0,2	18	84	36	18	3	
	MC716-20.0W3A-	20	0,3	20	92	42	20	3	

 Slot milling $a_p \leq 0.5 \times D_c$

 Shoulder milling $a_e \leq 0.6 \times D_c$

Ordering example for the WJ30TF grade: MC716-01.8W3A-WJ30TF

New addition to the product range

Solid carbide shoulder milling cutters MC129 Advance



- Type N 60

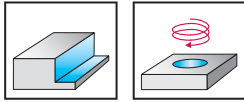

Z = 6

48HRC

	P	M	K	N	S	H	O
WJ30TF	●●	●	●	●	●		

DIN 6527 L		D_c h10 mm	L_c mm	l_1 mm	l_4 mm	d_1 h6 mm	Z	WJ30TF
Shank DIN 6535 HA	MC129-06.0A6B-	6	13	57	21	6	6	
	MC129-08.0A6B-	8	19	63	27	8	6	
	MC129-10.0A6B-	10	22	72	32	10	6	
	MC129-12.0A6B-	12	26	83	38	12	6	
	MC129-14.0A6B-	14	26	83	38	14	6	
	MC129-16.0A6B-	16	32	92	44	16	6	
	MC129-20.0A6B-	20	38	104	54	20	6	

Slot milling $a_p \leq 0.1 \times D_c$
 Shoulder milling $a_e \leq 0.1 \times D_c$
 Ordering example for the WJ30TF grade: MC129-06.0A6B-WJ30TF

WALTER SELECT

Best tool for

Good

Average

Poor

machining conditions

●● Primary application

● Other application

Solid carbide shoulder milling cutters

MC122 Advance



– Type N 45

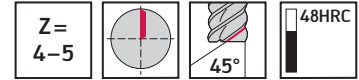
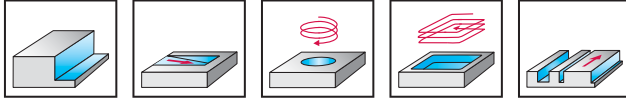

DIN 6527 L		D_c h10 mm	L_c mm	l_1 mm	l_4 mm	d_1 h6 mm	Z	WJ30TF
Shank DIN 6535 HA	MC122-02.0A4B-	2	7	57	21	6	4	🔴
	MC122-03.0A4B-	3	8	57	21	6	4	🔴
	MC122-04.0A4B-	4	11	57	21	6	4	🔴
	MC122-05.0A4B-	5	13	57	21	6	4	🔴
	MC122-06.0A4B-	6	13	57	21	6	4	🔴
	MC122-08.0A4B-	8	19	63	27	8	4	🔴
	MC122-10.0A4B-	10	22	72	32	10	4	🔴
	MC122-12.0A4B-	12	26	83	38	12	4	🔴
	MC122-14.0A4B-	14	26	83	38	14	4	🔴
	MC122-16.0A4B-	16	32	92	44	16	4	🔴
	MC122-18.0A5B-	18	32	92	44	18	5	🔴
	MC122-20.0A5B-	20	38	104	54	20	5	🔴
	Shank DIN 6535 HB	MC122-02.0W4B-	2	7	57	21	6	4
MC122-03.0W4B-		3	8	57	21	6	4	🔵
MC122-04.0W4B-		4	11	57	21	6	4	🔵
MC122-05.0W4B-		5	13	57	21	6	4	🔵
MC122-06.0W4B-		6	13	57	21	6	4	🔵
MC122-08.0W4B-		8	19	63	27	8	4	🔵
MC122-10.0W4B-		10	22	72	32	10	4	🔵
MC122-12.0W4B-		12	26	83	38	12	4	🔵
MC122-14.0W4B-		14	26	83	38	14	4	🔵
MC122-16.0W4B-		16	32	92	44	16	4	🔵
MC122-20.0W5B-		20	38	104	54	20	5	🔵
MC122-25.0A5B-		25	45	121	65	25	5	🔵

 Slot milling $a_p \leq 0.5 \times D_c$

 Shoulder milling $a_e \leq 0.5 \times D_c$

Ordering example for the WJ30TF grade: MC122-02.0A4B-WJ30TF

New addition to the product range

Solid carbide ball-nose end mills

MC416 Advance / MC416 Advance inch



- Type 30

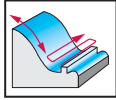

Z = 4

	P	M	K	N	S	H	O
WJ30TF	●	●	●	●	●		

P standard L		D _c h7 mm	R mm	L _c mm	l ₁ mm	l ₄ mm	d ₁ h6 mm	Z	WJ30TF
Shank DIN 6535 HA 	Designation								
	MC416-03.0A4L-	3	1,5	8	80	44	6	4	
	MC416-04.0A4L-	4	2	11	80	44	6	4	
	MC416-05.0A4L-	5	2,5	13	80	44	6	4	
	MC416-06.0A4L-	6	3	13	80	44	6	4	
	MC416-07.0A4L-	7	3,5	16	100	64	8	4	
	MC416-08.0A4L-	8	4	19	100	64	8	4	
	MC416-09.0A4L-	9	4,5	19	100	60	10	4	
	MC416-10.0A4L-	10	5	22	100	60	10	4	
	MC416-12.0A4L-	12	6	26	100	55	12	4	
	MC416-16.0A4L-	16	8	32	100	52	16	4	
	MC416-20.0A4L-	20	10	38	125	75	20	4	
Shank DIN 6535 HB 	Designation								
	MC416-03.0W4L-	3	1,5	8	80	44	6	4	
	MC416-04.0W4L-	4	2	11	80	44	6	4	
	MC416-05.0W4L-	5	2,5	13	80	44	6	4	
	MC416-06.0W4L-	6	3	13	80	44	6	4	
	MC416-08.0W4L-	8	4	19	100	64	8	4	
	MC416-10.0W4L-	10	5	22	100	60	10	4	
	MC416-12.0W4L-	12	6	26	100	55	12	4	
	MC416-16.0W4L-	16	8	32	100	52	16	4	
	MC416-20.0W4L-	20	10	38	125	75	20	4	

Ordering example for the WJ30TF grade: MC416-03.0A4L-WJ30TF

Tool		D _c h9 inches/no.	R inches	L _c inches	l ₁ inches	l ₄ inches	d ₁ h6 inches	Z	WJ30TF
	Designation								
	MC416.1.59A4D-	1/16"	0,031	0,187	2,000	0,583	1/4	4	
	MC416.2.38A4D-	3/32"	0,047	0,375	2,500	1,083	1/4	4	
	MC416.3.18A4D-	1/8"	0,063	0,500	2,500	1,083	1/4	4	
	MC416.4.75A4D-	3/16"	0,094	0,625	2,500	1,083	1/4	4	
	MC416.6.35A4D-	1/4"	0,125	0,750	2,500	1,083	1/4	4	
	MC416.7.94A4D-	5/16"	0,156	0,813	3,000	1,437	3/8	4	
	MC416.9.53A4D-	3/8"	0,188	0,875	3,000	1,437	3/8	4	
	MC416.11.1A4D-	7/16"	0,219	1,000	3,500	1,717	1/2	4	
	MC416.12.7A4D-	1/2"	0,250	1,000	3,500	1,717	1/2	4	
	MC416.15.9A4D-	5/8"	0,313	1,250	3,500	1,594	5/8	4	

Ordering example for the WJ30TF grade: MC416.1.59A4D-WJ30TF

WALTER SELECT

Best tool for

Good

Average

Poor

machining conditions

●● Primary application

● Other application

Solid carbide ball-nose end mills

MC416 Advance



– Type 30

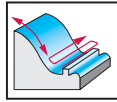

	P	M	K	N	S	H	O
WJ30TF	●	●	●	●	●		

DIN 6527 L		D_c h7 mm	R mm	L_c mm	l_1 mm	l_4 mm	d_1 h5 mm	Z	WJ30TF
Shank DIN 6535 HA	MC416-01.0A2B-	1	0,5	3	38	10	3	2	
	MC416-01.5A2B-	1,5	0,8	3	38	10	3	2	
	MC416-02.0A2B-	2	1	6	38	11	3	2	
	MC416-02.5A2B-	2,5	1,25	7	38	12	3	2	
	MC416-03.0A2B-	3	1,5	7	38	10	3	2	
	MC416-04.0A2B-	4	2	8	57	21	6	2	
	MC416-05.0A2B-	5	2,5	10	57	21	6	2	
	MC416-06.0A2B-	6	3	10	57	21	6	2	
	MC416-07.0A2B-	7	3,5	13	63	27	8	2	
	MC416-08.0A2B-	8	4	16	63	27	8	2	
	MC416-09.0A2B-	9	4,5	16	72	32	10	2	
	MC416-10.0A2B-	10	5	19	72	32	10	2	
	MC416-12.0A2B-	12	6	22	83	38	12	2	
	MC416-14.0A2B-	14	7	22	83	38	14	2	
	MC416-16.0A2B-	16	8	26	92	44	16	2	
	MC416-18.0A2B-	18	9	26	92	44	18	2	
	MC416-20.0A2B-	20	10	32	104	54	20	2	

Ordering example for the WJ30TF grade: MC416-01.0A2B-WJ30TF

New addition to the product range

Solid carbide ball-nose end mills MC413 Advance



- Long reach
- Type HSC 30

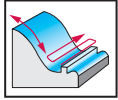

Z =
2-4

48HRC

	P	M	K	N	S	H	O
WJ30TF	●●	●	●	●	●		

P standard L		D _c h7 mm	R mm	L _c mm	l ₃ mm	d ₂ mm	l ₁ mm	l ₄ mm	d ₁ h5 mm	Z	WJ30TF
Shank DIN 6535 HA	Designation										
	MC413-01.0A2L-	1	0,5	2	20		75	39	6	2	●●
	MC413-02.0A2L-	2	1	3	20	1,7	75	39	6	2	●●
	MC413-03.0A2L-	3	1,5	4	30	2,5	80	44	6	2	●●
	MC413-04.0A2L-	4	2	5	30	3,3	80	44	6	2	●●
	MC413-05.0A2L-	5	2,5	7	43	4,1	80	44	6	2	●●
	MC413-06.0A2L-	6	3	7	30	4,7	100	64	6	2	●●
	MC413-08.0A2L-	8	4	9	36	6,5	100	64	8	2	●●
MC413-10.0A2L-	10	5	11	43	8,2	100	60	10	2	●●	

Ordering example for the WJ30TF grade: MC413-01.0A2L-WJ30TF

P standard L		D _c h7 mm	R mm	L _c mm	l ₃ mm	d ₂ mm	l ₁ mm	l ₄ mm	d ₁ h5 mm	Z	WJ30TF
Shank DIN 6535 HA	Designation										
	MC413-05.0A4L-	5	2,5	7	43	4,1	80	44	6	4	●●
	MC413-06.0A4L-	6	3	7	30	4,7	100	64	6	4	●●
	MC413-08.0A4L-	8	4	9	36	6,5	100	64	8	4	●●
	MC413-10.0A4L-	10	5	11	43	8,2	100	60	10	4	●●
	MC413-12.0A4L-	12	6	13	52	9,8	100	55	12	4	●●
MC413-16.0A4L-	16	8	15	61	13,4	150	102	16	4	●●	

Ordering example for the WJ30TF grade: MC413-05.0A4L-WJ30TF

WALTER SELECT

Best tool for

Good

Average

Poor

machining conditions

●● Primary application

● Other application

Solid carbide ball-nose end mills MC413 Advance



- Long reach
- Type HSC 30

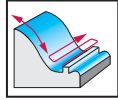

	P	M	K	N	S	H	O
WJ30TF	●	●	●	●	●		

P standard XL		D_c h7 mm	R mm	L_c mm	l_3 mm	d_2 mm	l_1 mm	l_4 mm	d_1 h5 mm	Z	WJ30TF
Shank DIN 6535 HA	MC413-04.0A2XC-	4	2	4	20	3,9	100	64	6	2	🔴
	MC413-04.0A2XD-	4	2	4	30	3,9	100	64	6	2	🔴
	MC413-04.0A2XE-	4	2	4	40	3,9	100	64	6	2	🔴
	MC413-05.0A2XC-	5	2,5	5	25	4,9	100	64	6	2	🔴
	MC413-05.0A2XD-	5	2,5	5	50	4,9	100	64	6	2	🔴
	MC413-06.0A4XC-	6	3	6	30	5,9	100	64	6	4	🔴
	MC413-06.0A4XD-	6	3	6	45	5,9	100	64	6	4	🔴
	MC413-06.0A4XE-	6	3	6	60	5,9	100	64	6	4	🔴
	MC413-08.0A4XC-	8	4	8	40	7,9	120	84	8	4	🔴
	MC413-08.0A4XD-	8	4	8	60	7,9	120	84	8	4	🔴
	MC413-08.0A4XE-	8	4	8	80	7,9	120	84	8	4	🔴
	MC413-10.0A4XD-	10	5	10	50	9,9	150	110	10	4	🔴
	MC413-10.0A4XE-	10	5	10	75	9,9	150	110	10	4	🔴
	MC413-12.0A4XD-	12	6	12	60	11,8	150	105	12	4	🔴

Ordering example for the WJ30TF grade: MC413-04.0A2XC-WJ30TF

🔴🔴🔴 New addition to the product range

Solid carbide chamfer milling cutter 60° MC500 Advance



- Type: Chamfer milling cutter 60°

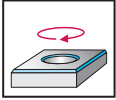

Z = 4

48HRC

WJ30TF	P	●	M	●	K	●	N	●	S	●	H	●	O
--------	---	---	---	---	---	---	---	---	---	---	---	---	---

P standard L		D _c mm	L _c mm	l ₁ mm	l ₄ mm	d ₁ h6 mm	Z	WJ30TF
Shank DIN 6535 HA	MC500-06.0A4L-	1	4,3	57	20	6	4	
	MC500-10.0A4L-	1,5	7,35	100	59	10	4	
Shank DIN 6535 HB	MC500-10.0W4L-	1,5	7,35	100	59	10	4	

Shoulder milling $a_e \leq 0,3 \times D_c$
Ordering example for the WJ30TF grade: MC500-06.0A4L-WJ30TF

WALTER SELECT

Best tool for

Good

Average

Poor

machining conditions

●● Primary application

● Other application

Solid carbide chamfer milling cutter 90° MC501 Advance



– Type: Chamfer milling cutter 90°

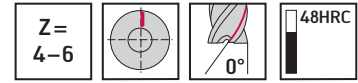
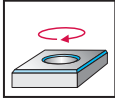

	P	M	K	N	S	H	O
WJ30TF	●	●	●	●	●		

P standard L

	Designation	D _c mm	L _c mm	l ₁ mm	l ₄ mm	d ₁ h6 mm	Z	WJ30TF
Shank DIN 6535 HA	MC501-06.0A4L-	1	2,5	57	21	6	4	15
	MC501-10.0A4L-	1,5	4,25	100	59	10	4	15
	MC501-08.0A5L-	2	3	80	43	8	5	15
	MC501-12.0A6L-	3	4,5	83	37	12	6	15
Shank DIN 6535 HB	MC501-06.0W4L-	1	2,5	57	21	6	4	15
	MC501-10.0W4L-	1,5	4,25	100	59	10	4	15
	MC501-08.0W5L-	2	3	80	43	8	5	15
	MC501-12.0W6L-	3	4,5	83	37	12	6	15

Shoulder milling $a_e \leq 0.3 \times D_c$

Ordering example for the WJ30TF grade: MC501-06.0A4L-WJ30TF

Solid carbide chamfer milling cutter 120° MC502 Advance



– Type: Chamfer milling cutter 120°

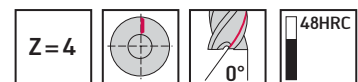
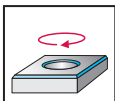

	P	M	K	N	S	H	O
WJ30TF	●	●	●	●	●		

P standard L

	Designation	D _c mm	L _c mm	l ₁ mm	l ₄ mm	d ₁ h6 mm	Z	WJ30TF
Shank DIN 6535 HA	MC502-10.0A4L-	1,5	2,45	100	60	10	4	15

Shoulder milling $a_e \leq 0.3 \times D_c$

Ordering example for the WJ30TF grade: MC502-10.0A4L-WJ30TF

New addition to the product range

Solid carbide quarter-round profile milling cutters MC503 Advance

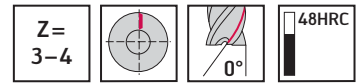

	P	M	K	N	S	H	O
WJ30TF	●	●	●	●	●		

DIN 6527 L		R	D _c	L _c	l ₁	l ₄	d ₁ h6	Z	WJ30TF
Designation		mm	mm	mm	mm	mm	mm		
Shank DIN 6535 HA	MC503-04.0A3B050-	0,5	4	0,5	57	21	6	3	●
	MC503-04.0A3B075-	0,75	4	0,75	57	21	6	3	●
	MC503-04.0A3B080-	0,8	4	0,8	57	21	6	3	●
	MC503-04.0A4B100-	1	4	1	63	27	8	4	●
	MC503-04.0A4B150-	1,5	4	1,5	63	27	8	4	●
	MC503-05.0A4B200-	2	5	2	72	32	10	4	●
	MC503-05.0A4B250-	2,5	5	2,5	72	32	10	4	●
	MC503-05.0A4B300-	3	5	3	83	38	12	4	●
	MC503-06.0A4B400-	4	6	4	83	38	14	4	●
	MC503-06.0A4B500-	5	6	5	92	44	16	4	●
MC503-08.0A4B600-	6	8	6	104	54	20	4	●	

Ordering example for the WJ30TF grade: MC503-04.0A3B050-WJ30TF

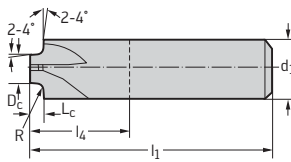

Solid carbide front & back chamfer/deburr MC504 Advance



- Long reach
- Type: Forward/backward deburrer

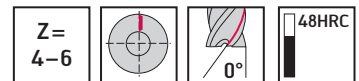
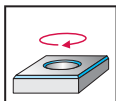

	P	M	K	N	S	H	O
WJ30TF	●	●	●	●	●		

P standard L		D _a	L _c	l ₃	d ₂	l ₁	l ₄	d ₁ h6	Z	WJ30TF
Designation		mm	mm	mm	mm	mm	mm	mm		
Shank DIN 6535 HA	MC504-06.0A4LB-	6	4,25	19	3,9	100	64	6	4	●
	MC504-08.0A4L-	8	2			100	64	6	4	●
	MC504-10.0A6L-	10	4			100	64	6	6	●
	MC504-12.0A6L-	12	6			100	64	6	6	●

Ordering example for the WJ30TF grade: MC504-06.0A4LB-WJ30TF

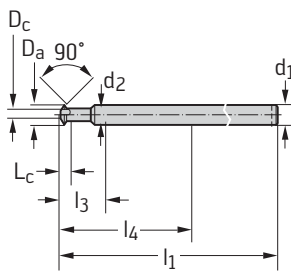

Walter BLAXX M3255 porcupine milling cutter – maximum metal removal rate on titanium.

NEW FOR 2016

THE TOOL

- Full effective porcupine milling cutter with tangential indexable inserts
- Four cutting edges on the circumference, two cutting edges on the axial face insert
- Diameter range 50–80 mm or 2–3"
- High volume of carbide in the direction of the cutting force
- Reinforced core possible due to the tangential indexable insert system
- Precise 90° angle on the component

THE APPLICATION

- For slot, shoulder, contour and pocket milling in titanium alloys
- For roughing operations
- Ideally suited to structural components for the aeronautical industry

THE INDEXABLE INSERTS

Face insert:

- One indexable insert size XNHX1306..
- 2 cutting edges
- Various corner radii (0.8–4.0 mm)
- Axial positioning via interlock within the body
- L65T geometry

Circumference insert:

- One indexable insert size LNHX120604R
- 4 cutting edges
- Helical cutting edges and positive rake angle
- L65T geometry



Axial positioning via interlock within the body

Positive cutting characteristics

Superb chip removal thanks to targeted coolant supply and optimum chip clearance

Walter BLAXX porcupine milling cutter

Fig.: M3255

BENEFITS FOR YOU

- High process reliability due to stable design
- Precise coolant supply at each individual cutting edge, also suitable for high-pressure cooling
- High cost efficiency thanks to four cutting edges on the radial inserts and two edges on the axial inserts.
- Maximum metal removal rate thanks to maximum number of teeth
- Short machining times thanks to high metal removal rate
- Soft-cutting geometry thanks to helical cutting edges and positive rake angle

Ordering information from page 98.

THE GEOMETRY

L65T – The special one:

- Specifically developed for titanium alloys
- Available in the WSP45S and WSM45X grades
- Low cutting forces

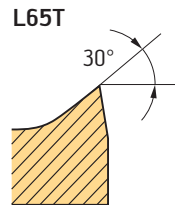

LNHX...-L65T



XNHX...-L65T

Powered by
Tiger-tec[®]Silver

APPLICATION EXAMPLE

Brake lever – milling the outer profile

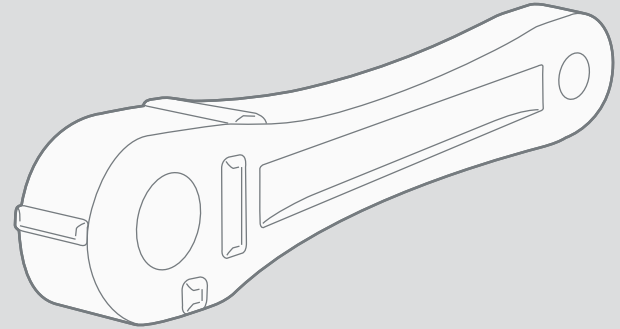

Material: Ti 10-2-3, ISO S
Tool: M3255/dia. 63 mm/Z5
Insert: LNHX120604R-L65T/XNHX130608-L65T
Cutting material: WSM45X

Cutting data:

v_c	30 m/min
f_z	0.08 mm
v_f	60 mm/min
a_e	25–30 mm
a_p	50–60 mm
Q	108 cm ³ /min

Comparison: Tool life [min]

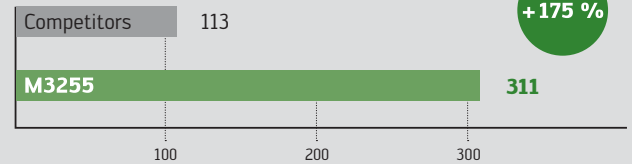

Watch product animation:
Scan this QR code or go directly
to <http://goo.gl/XcmLc7>



M4256, M4257 and M4258 porcupine milling cutters: A new Universal dimension in long edge milling.

NEW FOR 2016

THE TOOLS

- Half effective porcupine milling cutter
- Diameter range 20–100 mm or 3/4–4"
- Interfaces: Weldon shank, bore adaptor, modular ScrewFit interface
- M4256 equipped with SD..06T2.. and LD..08T2..
- M4257 equipped with SD..09T3.. and LD..14T3..
- M4258 equipped with SD..1204.. and LD..1704..

THE INDEXABLE INSERTS

- 15° clearance angle
- Circumference-sintered design for maximum cost efficiency
- Two CVD-coated grades (WKP25S and WKP35S) for machining steel and cast iron
- Three PVD-coated grades (WKK25S, WSM35S and WSP45S) for machining Irons, Stainless' and difficult to cut alloys.

Square system inserts from the M4000 milling system

- For universal use in face, shoulder, chamfer and T-slot milling cutters and also as the leading insert in slot drill and porcupine milling cutters
- 4 cutting edges

Rhombic indexable inserts:

- Can be used as a face insert in slot drill and porcupine milling cutters
- 2 cutting edges

THE APPLICATION

- For shoulder and slot milling
- For steel, cast iron, stainless steels and difficult-to-cut materials

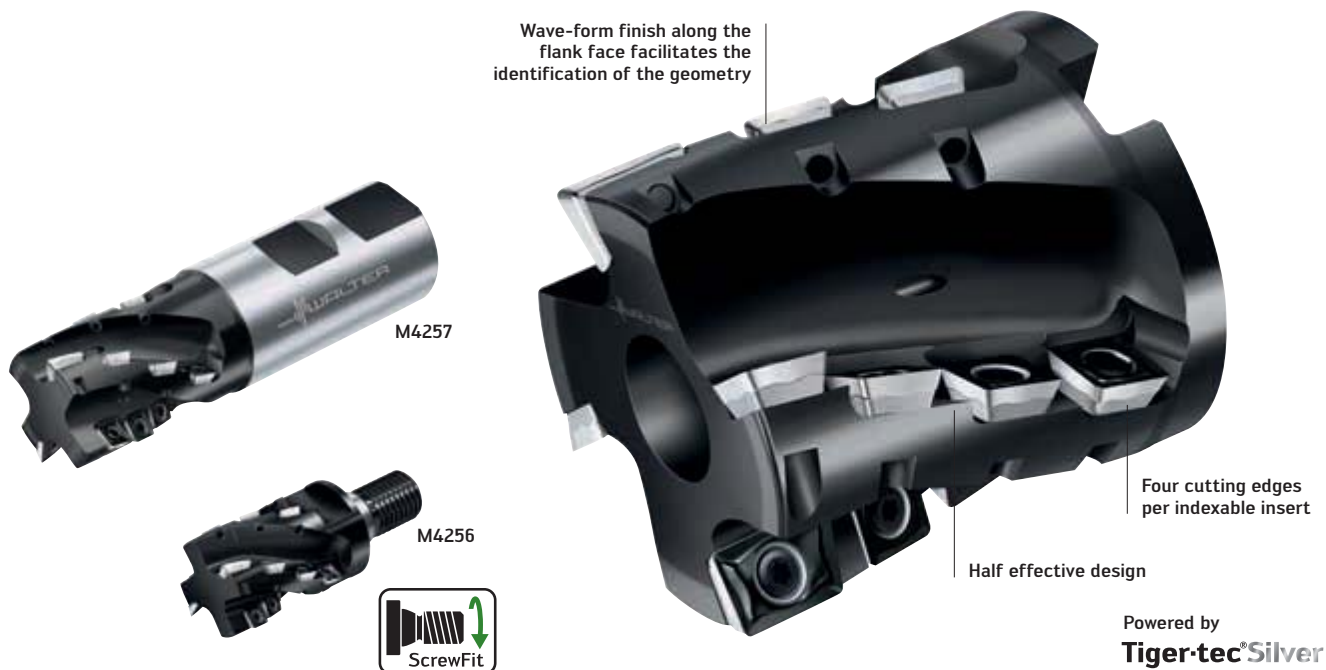

Walter porcupine milling cutters

Fig.: M4258

BENEFITS FOR YOU

- High cost efficiency thanks to four or two cutting edges per indexable insert
- Reduced procurement and inventory costs
- Concept requiring minimum resources
- Low power requirement thanks to positive geometries
- Walter Green: CO₂ emissions resulting from production are offset by our environmental protection project (see p. 2)

Walter Green

THE GEOMETRIES

A57 – the special one:

- Unfavourable machining conditions
- Maximum cutting edge stability
- High feed rates
- Straight line indicator (no wave on the flank face)

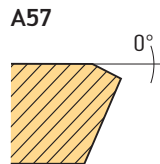

D51 – the quiet one:

- Anti-vibration geometry
- For tools with long projection lengths
- One wave on the flank face

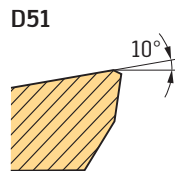

D57 – the stable one:

- Average machining conditions
- For universal use
- One wave on the flank face

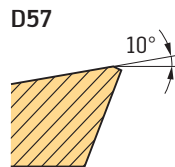

F57 – the universal one:

- Good machining conditions
- Low cutting forces
- Medium feed rates
- Two waves on the flank face

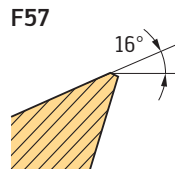

APPLICATION EXAMPLE

Hinge machining

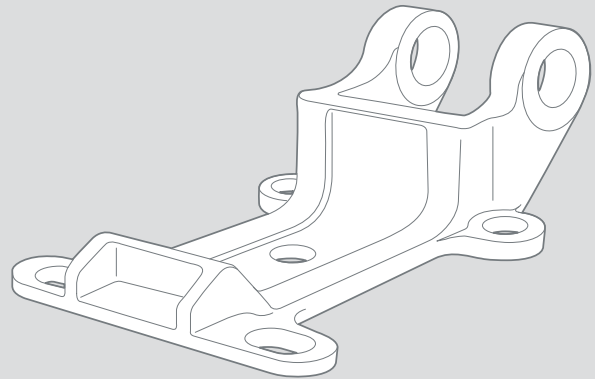

Material: ST-52, ISO P (1.0570)
Tool: M4257/dia. 50 mm/Z2
Indexable inserts: LDMT14T308R-D57/SDMT09T308R-D57
Cutting material: WKP35S

Cutting data:

	Competitors	Walter
v_c	250 m/min	250 m/min
n	1590 rpm	1590 rpm
f_z	0.11 mm	0.225 mm
v_f	835 mm/min	715 mm/min
a_e	1,5 mm	3 mm
a_p	37.5 mm	37.5 mm
Power requirement	3.0–4.5 kW	2.0–3.5 kW
Q	47 cm ³ /min	81 cm ³ /min

Tool life quantity comparison [pcs]

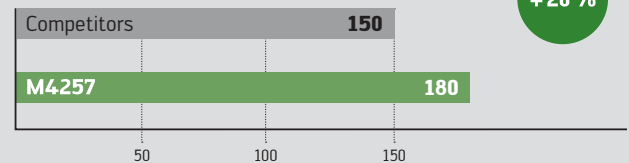

Walter BLAXX M3024 heptagon face milling cutter – now with a new finishing insert.

NEW TO THE RANGE

NEW ADDITION TO THE PRODUCT RANGE

- Special indexable inserts for finishing: XNGX0705ANN-F67

THE INDEXABLE INSERTS

For finishing:

XNGX0705ANN-F67

- Two + two cutting edges

For roughing: XN.U0705...

- 14 cutting edges with negative basic shape
- Positive cutting edge geometry
- Facet design (XN.U0705ANN...)
- or corner radius design (XNMU070508...)

THE APPLICATION

- Face milling in all steel and cast iron materials as well as in stainless steels
- Perfect for machining components such as exhaust turbochargers, turbine blades, etc.

THE TOOLS

- Walter BLAXX 45° face milling cutter
- Maximum cutting depth 4 mm
- Diameter range 40–160 mm or 3/4–6"
- Surface protected against corrosion and wear

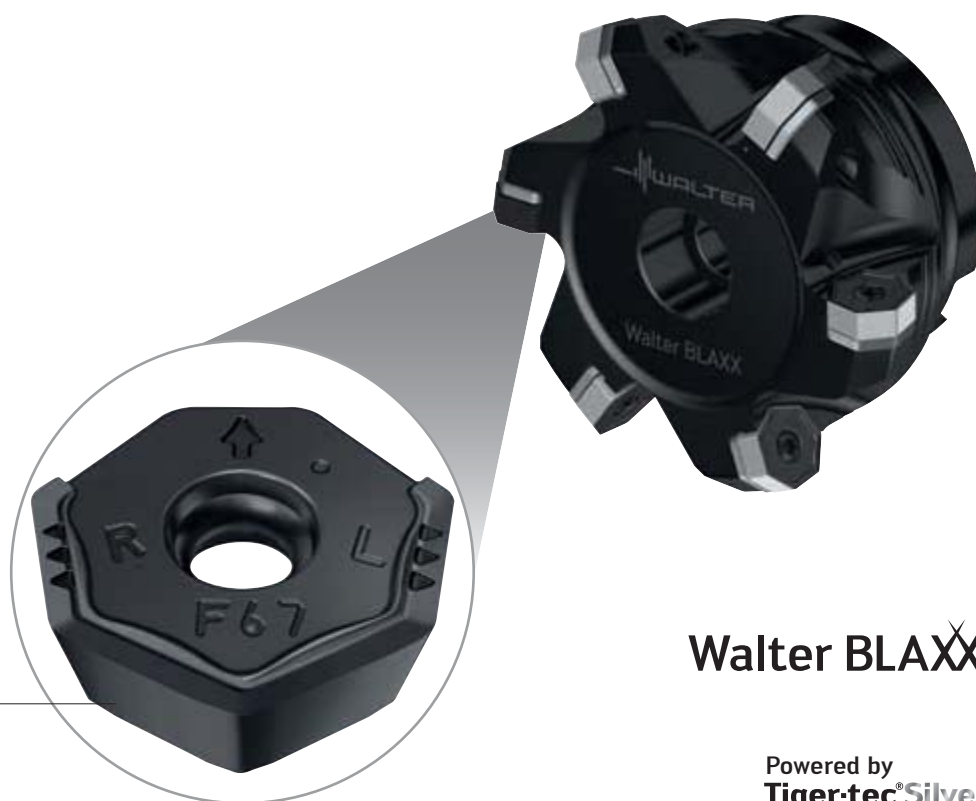

XNGX0705ANN-F67

Walter BLAXX

Powered by
Tiger-tec[®]Silver

Walter BLAXX heptagon milling cutter

Fig.: M3024

Ordering information
from page 91.



Watch product animation:
Scan this QR code or go directly
to <http://goo.gl/YUfnyR>

BENEFITS FOR YOU

- Excellent cost efficiency thanks to high metal removal rate, even on low-performance machines
- Soft cutting action thanks to positive cutting edge geometry
- Low cutting material costs thanks to 14 cutting edges per insert
- High level of process reliability thanks to stable negative inserts
- Optimum insert support face and high feed per tooth due to solid carbide shim

New finishing insert for Walter BLAXX shoulder milling cutters – operate at a higher feed rate without steps.

NEW TO THE RANGE

NEW ADDITION TO THE PRODUCT RANGE

- Special indexable insert for finishing: LNHX130608R-L55T

THE INDEXABLE INSERTS

For finishing:

- LNHX0904PDR-L55T and LNHX1306PDR-L55T – with two cutting edges for highest feed rates per revolution
- LNHX130608R-L55T – with four cutting edges for flat, uniform surfaces removing final grinding requirement

For roughing:

- Three indexable insert sizes: LNHU0904../LNHU1306../LNHU1607..
- Three different geometries: L55T, L65T and L85T

THE APPLICATION

- Shoulder and face milling
- For steel, cast iron, stainless steels, difficult-to-cut materials and aluminium
- Areas of use: The automotive industry, aerospace industry and general mechanical engineering

THE TOOLS

- F5041, F5141 and F5241 tangential shoulder milling cutters
- High volume of carbide in the direction of the cutting force and reinforced core
- Diameter range 25–160 mm
- 3 cutting depths: 8.0 / 12.0 / 15.0 mm
- Precise 90° angle on the component



4 usable cutting edges

LNHX130608R-L55T finishing insert for high feed rates per revolution

LNHU...-L55T tangential indexable inserts

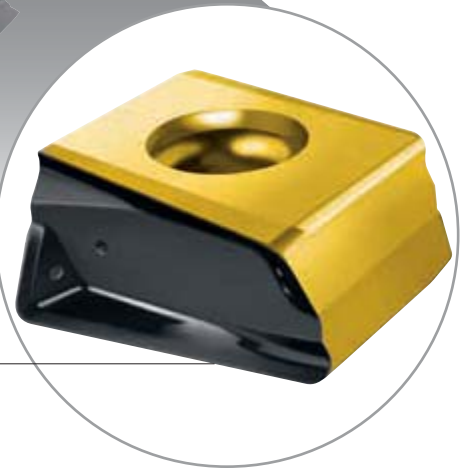

Walter BLAXX

Powered by
Tiger-tec Silver

Walter BLAXX shoulder milling cutter

Fig.: F5141

BENEFITS FOR YOU

- Highly flexible in use
- Extreme process reliability thanks to high radial and axial runout accuracy
- Special tool body surface treatment protects against corrosion and wear
- Soft-cutting indexable insert geometries thanks to helical cutting edges
- Excellent surface quality thanks to finishing inserts
- High cost efficiency thanks to more cutting edges per diameter and up to 30% higher feed rate per tooth

Ordering information
from page 91.

Finishing inserts LNHX Tiger-tec®

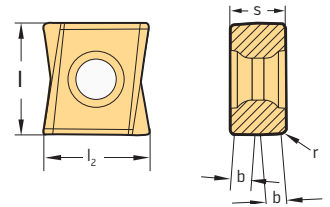

Indexable inserts

Designation	Tolerance class	Number of cutting edges	l ₂ mm	l mm	s mm	r mm	b mm	P			M		K			N		S		H	O	
								WKP25S	WKP35S	WSP45S	WSP45S	WSP45S	WAK15	WKK25S	WKP25S	WKP35S	WC	HW	WC	HW	WC	HW
 LNHX130608R-L55T	H	4	12	13	6,8	0,8	2,2															

HC = Coated carbide
HW = Uncoated carbide

Finishing inserts XNGX Tiger-tec®

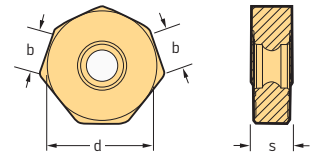

Indexable inserts

Designation	Tolerance class	Number of cutting edges	d mm	s mm	b mm	P			M		K			N		S		H	O	
						WKP25S	WKP35S	WSP45S	WSP45S	WSP45S	WAK15	WKK25S	WKP25S	WKP35S	WC	HW	WC	HW	WC	HW
 XNGX0705ANN-F67	G	2	14,5	4,6	5,7															

HC = Coated carbide
HW = Uncoated carbide

High-feed face milling cutter M4002



– Four cutting edges per indexable insert

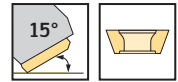
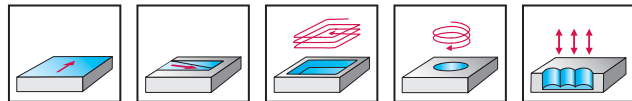

	P	M	K	N	S	H	O
M4002	●●	●●	●●	●●	●●	●	●

Tool	Designation	D _c mm	D _a * mm	d ₁ mm	l ₄ mm	l ₁ mm	L _c mm	a _r mm	Z	kg	No. of indexable inserts	Type
ScrewFit 	M4002-020-T18-02-01	8	20	T18	30		1	5,7	2	0,1	2	SDM . 06T2 ..
	M4002-025-T22-02-01,5	8	25	T22	40		1,5	8,4	2	0,1	2	SDM . 09T3 ..
	M4002-025-T22-03-01	13	25	T22	35		1	5,7	3	0,1	3	SDM . 06T2 ..
	M4002-032-T28-03-01,5	15	32	T28	40		1,5	8,4	3	0,2	3	SDM . 09T3 ..
	M4002-035-T28-03-01,5	18	35	T28	40		1,5	8,4	3	0,2	3	
	M4002-032-T28-04-01	20	32	T28	40		1	5,7	4	0,2	4	SDM . 06T2 ..
	M4002-035-T28-03-01	23	35	T28	40		1	5,7	3	0,3	3	
	★ M4002-035-T28-04-01	23	35	T28	40		1	5,7	4	0,2	4	
	M4002-040-T36-04-01,5	23	40	T36	40		1,5	8,4	4	0,3	4	SDM . 09T3 ..
	M4002-042-T36-03-01,5	25	42	T36	40		1,5	8,4	3	0,4	3	
M4002-040-T36-05-01	28	40	T36	40		1	5,7	5	0,4	5	SDM . 06T2 ..	
M4002-042-T36-04-01	30	42	T36	40		1	5,7	4	0,4	4		
★ M4002-042-T36-05-01	30	42	T36	40		1	5,7	5	0,4	5		
Shank DIN 1835 A 	M4002-020-A20-02-01	8	20	20	30	200	1	5,7	2	0,5	2	SDM . 06T2 ..
	M4002-025-A25-03-01	13	25	25	35	200	1	5,7	3	0,8	3	
	M4002-032-A32-04-01	20	32	40	40	250	1	5,7	4	1,5	4	

* Measured using SDM.06T204, SDM.09T308, SDM.120408
Bodies and assembly parts are included in the scope of delivery.

★ New addition to the product range

Assembly parts

Type	SDM . 06T2 ..	SDM . 09T3 ..
 Clamping screw for indexable insert Tightening torque	FS2084 (Torx 7 IP) 0.9 Nm	FS2266 (Torx 10 IP) 2.0 Nm

Accessories

Type	SDM . 06T2 ..	SDM . 09T3 ..
 Torque screwdriver, analogue	FS2001	FS2003
 Torque screwdriver, digital Tightening torque		FS2248 1.0–6 Nm
 Interchangeable blade	FS2011 (Torx 7 IP)	FS2268 (Torx 10 IP)
 Screwdriver	FS2088 (Torx 7 IP)	FS2267 (Torx 10 IP)

Indexable inserts

Designation	r mm	b mm	P		M			K			S		O	
			HC		HC			HC			HC		HF	
			WKP25S	WKP35S	WSP45S	WSM35S	WSM45X	WSP45S	WAK15	WKK25S	WKP25S	WKP35S	WSM35S	WSM45X
 SDMT06T2ZDR-D57 SDMT09T3ZDR-D57	0,4	1,2	☺	☺	☺									
	0,8	1,2	☺	☺				☺						
 SDMT06T204-D57 SDMT06T204-F57 SDMT06T212-F57 SDMW06T204-A57 SDMT09T308-D57 SDMT09T308-F57 SDMT09T320-F57 SDMW09T308-A57	0,4		☺	☺	☺	☺			☺	☺	☺	☺		
	0,4		☺	☺	☺	☺	☺	☺	☺	☺	☺	☺	☺	
	1,2		☺	☺	☺	☺	☺							
	0,4		☺	☺					☺	☺				
	0,8		☺	☺	☺	☺			☺	☺	☺	☺	☺	
	0,8		☺	☺	☺	☺	☺	☺	☺	☺	☺	☺	☺	
	2		☺	☺	☺	☺	☺							
	0,8		☺	☺					☺	☺				

For SD..120425 indexable inserts, the circumference of the body must be reworked:
 $R_{(body)} = r_{(indexable\ insert)}$

HC = Coated carbide
 HF = Uncoated fine-grain carbide

WALTER SELECT

Stability of machine, workpiece and clamping arrangement

☺
Very good

☺
Good

☺
Moderate

•• Primary application

• Other application

High-feed face milling cutter M4002



– Four cutting edges per indexable insert

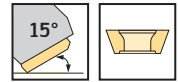
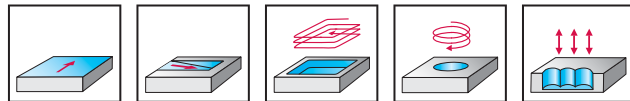

	P	M	K	N	S	H	O
M4002	●●	●●	●●	●●	●●	●	●

Tool	Designation	D _c mm	D _a * mm	d ₁ mm	l ₄ mm	l ₁ mm	L _c mm	a _r mm	Z	kg	No. of indexable inserts	Type
Parallel bore DIN 138 transverse keyway 	M4002-042-B16-04-01,5	25	42	16	40		1,5	8,4	4	0,2	4	SDM . 09T3 ..
	M4002-050-B22-04-02	27	50	22	40		2	11,4	4	0,3	4	SDM . 1204 ..
	M4002-040-B16-05-01	28	40	16	40		1	5,7	5	0,2	5	SDM . 06T2 ..
	M4002-052-B22-03-02	29	52	22	40		2	11,4	3	0,3	3	SDM . 1204 ..
	★ M4002-052-B22-04-02	29	52	22	40		2	11,4	4	0,3	4	SDM . 1204 ..
	M4002-042-B16-04-01	30	42	16	40		1	5,7	4	0,2	4	SDM . 06T2 ..
	★ M4002-042-B16-05-01	30	42	16	40		1	5,7	5	0,2	5	SDM . 06T2 ..
	M4002-050-B22-05-01,5	33	50	22	40		1,5	8,4	5	0,3	5	SDM . 09T3 ..
	M4002-052-B22-04-01,5	35	52	22	40		1,5	8,4	4	0,4	4	SDM . 09T3 ..
	M4002-052-B22-05-01,5	35	52	22	40		1,5	8,4	5	0,3	5	SDM . 09T3 ..
	M4002-050-B22-07-01	38	50	22	40		1	5,7	7	0,3	7	SDM . 06T2 ..
	M4002-052-B22-06-01	40	52	22	40		1	5,7	6	0,4	6	SDM . 06T2 ..
	★ M4002-052-B22-07-01	40	52	22	40		1	5,7	7	0,4	7	SDM . 06T2 ..
	M4002-063-B22-05-02	40	63	22	50		2	11,4	5	0,5	5	SDM . 1204 ..
	M4002-066-B27-04-02	43	66	27	50		2	11,4	4	0,8	4	SDM . 1204 ..
	★ M4002-066-B27-05-02	43	66	27	50		2	11,4	5	0,7	5	SDM . 1204 ..
	M4002-063-B22-06-01,5	46	63	22	50		1,5	8,4	6	0,8	6	SDM . 09T3 ..
	M4002-066-B27-05-01,5	49	66	27	50		1,5	8,4	5	0,9	5	SDM . 09T3 ..
	M4002-066-B27-06-01,5	49	66	27	50		1,5	8,4	6	0,8	6	SDM . 09T3 ..
	M4002-063-B22-08-01	51	63	22	50		1	5,7	8	0,6	8	SDM . 06T2 ..
	M4002-066-B27-07-01	54	66	27	50		1	5,7	7	0,8	7	SDM . 06T2 ..
	★ M4002-066-B27-08-01	54	66	27	40		1	5,7	8	0,8	8	SDM . 06T2 ..
	M4002-080-B27-06-02	57	80	27	50		2	11,4	6	1,3	6	SDM . 1204 ..
	M4002-085-B27-05-02	62	85	27	50		2	11,4	5	1,5	5	SDM . 1204 ..
	★ M4002-085-B27-06-02	62	85	27	50		2	11,4	6	1,4	6	SDM . 1204 ..
	M4002-100-B32-07-02	77	100	32	60		2	11,4	7	2,6	7	SDM . 1204 ..
	M4002-125-B40-08-02	102	125	40	60		2	11,4	8	3	8	SDM . 1204 ..

* Measured using SDM.06T204, SDM.09T308, SDM.120408
 Bodies and assembly parts are included in the scope of delivery.

★ New addition to the product range

Assembly parts

Type	SDM . 06T2 ..	SDM . 09T3 ..	SDM . 1204 ..
Clamping screw for indexable insert Tightening torque	FS2084 (Torx 7 IP) 0.9 Nm	FS2266 (Torx 10 IP) 2.0 Nm	FS1453 (Torx 15 IP) 3.5 Nm

Accessories

Type	SDM . 06T2 ..	SDM . 09T3 ..	SDM . 1204 ..
Torque screwdriver, analogue	FS2001	FS2003	FS2003
Torque screwdriver, digital Tightening torque		FS2248 1.0–6 Nm	FS2248 1.0–6 Nm
Interchangeable blade	FS2011 (Torx 7 IP)	FS2268 (Torx 10 IP)	FS2014 (Torx 15 IP)
Screwdriver	FS2088 (Torx 7 IP)	FS2267 (Torx 10 IP)	FS1485 (Torx 15 IP)

Indexable inserts

Designation	r mm	b mm	P		M		K		S		O					
			HC	HF	HC	HF	HC	HF	HC	HF	HF					
			WKP25S	WKP35S	WSP45S	WSM35S	WSM45X	WSP45S	WAK15	WKK25S	WKP25S	WKP35S	WSM35S	WSM45X	WSP45S	WMG40
SDMT06T2ZDR-D57	0,4	1,2	☺	☺	☺											
SDMT09T3ZDR-D57	0,8	1,2	☺	☺	☺											
SDMT1204ZDR-D57	0,8	1,8	☺	☺	☺											
SDMT06T204-D57	0,4		☺	☺	☺	☺		☺	☺	☺	☺	☺	☺	☺	☺	
SDMT06T204-F57	0,4		☺	☺	☺	☺		☺	☺	☺	☺	☺	☺	☺	☺	
SDMT06T212-F57	1,2		☺	☺	☺	☺		☺	☺	☺	☺	☺	☺	☺	☺	
SDMW06T204-A57	0,4		☺	☺	☺					☺	☺	☺	☺	☺	☺	
SDMT09T308-D57	0,8		☺	☺	☺	☺		☺	☺	☺	☺	☺	☺	☺	☺	
SDMT09T308-F57	0,8		☺	☺	☺	☺		☺	☺	☺	☺	☺	☺	☺	☺	
SDMT09T320-F57	2		☺	☺	☺	☺		☺	☺	☺	☺	☺	☺	☺	☺	
SDMW09T308-A57	0,8		☺	☺	☺					☺	☺	☺	☺	☺	☺	
SDMT120408-D57	0,8		☺	☺	☺	☺		☺	☺	☺	☺	☺	☺	☺	☺	
SDMT120408-F57	0,8		☺	☺	☺	☺		☺	☺	☺	☺	☺	☺	☺	☺	
SDMT120425-F57	2,5		☺	☺	☺	☺		☺	☺	☺	☺	☺	☺	☺	☺	
SDMW120408-A57	0,8		☺	☺	☺					☺	☺	☺	☺	☺	☺	

For SD..120425 indexable inserts, the circumference of the body must be reworked:

$$R_{(body)} = r_{(indexable\ insert)}$$

HC = Coated carbide

HF = Uncoated fine-grain carbide

WALTER SELECT

Stability of machine, workpiece and clamping arrangement

☺
Very good

☺
Good

☺
Moderate

●● Primary application

● Other application

Ramping milling cutter

M2131



- Two cutting edges per indexable insert
- For pocket machining

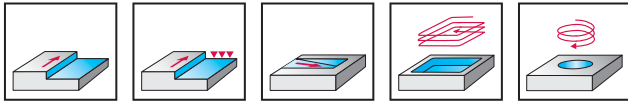
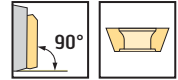

	P	M	K	N	S	H	O
M2131				●●			●

Tool	Designation	D _c mm	d ₁ mm	l ₄ mm	l ₁ mm	l ₁₆ mm	L _c mm	Z	kg	No. of indexable inserts	Type
ScrewFit 	M2131-025-T22-02-15	25	T22	45			15	2	0,1	2	ZDGT1504 .. R
	M2131-032-T28-02-15	32	T28	50			15	2	0,2	2	ZDGT2005 .. R
	M2131-032-T28-02-20	32	T28	50			20	2	0,2	2	ZDGT1504 .. R
	M2131-032-T28-03-15	32	T28	50			15	3	0,2	3	ZDGT2005 .. R
	M2131-040-T36-02-20	40	T36	50			20	2	0,3	2	ZDGT2005 .. R
	M2131-040-T36-03-15	40	T36	50			15	3	0,4	3	ZDGT1504 .. R
Shank DIN 1835 A 	M2131-025-A20-02-15-S	25	20	40	110		15	2	0,2	2	ZDGT1504 .. R
	M2131-025-A25-02-15-L	25	25	40	150		15	2	0,5	2	
	M2131-032-A20-02-15-S	32	20	40	110		15	2	0,3	2	
	M2131-032-A20-03-15-S	32	20	40	110		15	3	0,3	3	
	M2131-032-A25-02-15-L	32	25	40	175		15	2	0,6	2	ZDGT2005 .. R
	M2131-032-A25-03-15-L	32	25	40	175		15	3	0,6	3	
	M2131-032-A25-02-20-L	32	25	40	175		20	2	0,6	2	ZDGT1504 .. R
	M2131-032-A32-02-15-L	32	32	50	175		15	2	1,0	2	ZDGT2005 .. R
	M2131-032-A32-02-20-L	32	32	50	175		20	2	0,9	2	ZDGT1504 .. R
	M2131-032-A32-03-15-L	32	32	50	175		15	3	0,9	3	ZDGT2005 .. R
M2131-040-A32-02-20-L	40	32	50	175		20	2	1,0	2	ZDGT1504 .. R	
M2131-040-A32-03-15-L	40	32	50	175		15	3	1,0	3	ZDGT2005 .. R	
HSK DIN 69893/1-A 	M2131-025-H63-02-15	25	HSK-A63	110		60	15	2	0,9	2	ZDGT1504 .. R
	M2131-032-H63-02-15	32	HSK-A63	110		65	15	2	1,1	2	
	★ M2131-032-H63-03-15	32	HSK-A63	110		65	15	3	1,0	3	ZDGT2005 .. R
	M2131-040-H63-02-20	40	HSK-A63	110		65	20	2	1,2	2	
	M2131-050-H63-04-15	50	HSK-A63	110		80	15	4	1,5	4	ZDGT1504 .. R
	M2131-050-H63-03-20	50	HSK-A63	110		80	20	3	1,4	3	ZDGT2005 .. R
	M2131-050-H80-04-15-D	50	HSK-A80/A63	110		80	15	4	1,9	4	ZDGT1504 .. R
	M2131-050-H80-03-20-D	50	HSK-A80/A63	110		80	20	3	1,8	3	ZDGT2005 .. R
	M2131-063-H63-04-20	63	HSK-A63	110		80	20	4	1,6	4	ZDGT1504 .. R
	M2131-063-H63-05-15	63	HSK-A63	110		80	15	5	1,7	5	
Parallel bore DIN 138 transverse keyway 	M2131-040-B16-03-15	40	16	50			15	3	0,2	3	ZDGT1504 .. R
	M2131-050-B22-03-20	50	22	60			20	3	0,4	3	ZDGT2005 .. R
	M2131-050-B22-04-15	50	22	50			15	4	0,4	4	ZDGT1504 .. R
	M2131-063-B22-04-20	63	22	50			20	4	0,5	4	ZDGT2005 .. R
	M2131-063-B22-05-15	63	22	50			15	5	0,6	5	ZDGT1504 .. R
	M2131-080-B27-05-15	80	27	60			15	5	1,3	5	

Tool with HSK balanced to G6.3 where n = 20,000 rpm, with sensing chip recess, but without chip

Other tools balanced to G6.3 where n = 10,000 rpm

M2131-...-D special interface for Dörries Scharmann (similar to HSK-A DIN 69893)

Accessories for HSK – see "Assembly parts and accessories"

For arbour-mounted tools, use longer tightening screws in accordance with ISO 4763

Bodies and assembly parts are included in the scope of delivery.

★ New addition to the product range

Assembly parts		ZDGT1504 .. R 25–32	ZDGT1504 .. R 40–63	ZDGT2005 .. R 32	ZDGT2005 .. R 40–63
	Type D _c mm Clamping screw for indexable insert Tightening torque	FS1222 (Torx 15 IP) 3.5 Nm	FS1453 (Torx 15 IP) 3.5 Nm	FS2139 (Torx 20 IP) 5.0 Nm	FS2281 (Torx 20 IP) 5.0 Nm

Accessories		ZDGT1504 .. R	ZDGT2005 .. R
	Torque screwdriver, analogue	FS2003	FS2003
	Torque screwdriver, digital Tightening torque	FS2248 1.0–6 Nm	FS2248 1.0–6 Nm
	Interchangeable blade	FS2014 (Torx 15 IP)	FS2015 (Torx 20 IP)
	Screwdriver	FS1485 (Torx 15 IP)	FS1486 (Torx 20 IP)

Indexable inserts

Designation	r mm	b mm	P			M		K			N			S		O
			HC			HC		HC			HC			HC		HF
			WKP25S	WKP35S	WSP45S	WSM35S	WSP45S	WAK15	WKK25S	WKP25S	WKP35S	WXN15	WNN15	WK10	WSM35S	WSP45S
ZDGT150404R-K85	0,4	1,2														
ZDGT150408R-K85	0,8	1,2														
ZDGT150412R-K85	1,2	1,2														
ZDGT150416R-K85	1,6	1,2														
ZDGT150420R-K85	2	1,2														
ZDGT150425R-K85	2,5	1,2														
ZDGT150430R-K85	3	1,2														
ZDGT150440R-K85	4	1,2														
ZDGT200508R-K85	0,8	1,2														
ZDGT200512R-K85	1,2	1,2														
ZDGT200516R-K85	1,6	1,2														
ZDGT200520R-K85	2	1,2														
ZDGT200530R-K85	3	1,2														
ZDGT200540R-K85	4	1,2														
ZDGT200550R-K85	5	1,2														
ZDGT200560R-K85	6	1,2														
ZDGT200564R-K85	6,4	1,2														

If the corner radius $r = 2.0$ mm or above, the corner area of the body must be reworked:
 $R_{(body)} = r_{(indexable\ insert)} - 1\text{ mm}$

HC = Coated carbide
 HW = Uncoated carbide
 HF = Uncoated fine-grain carbide

WALTER SELECT

Stability of machine, workpiece and clamping arrangement

Very good

Good

Moderate

●● Primary application

● Other application

Porcupine milling cutters

M3255

Walter BLAXX



- Full effective design
- Two or four cutting edges per indexable insert, tangential arrangement

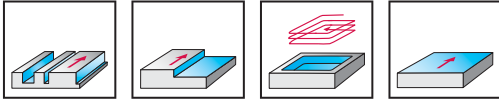
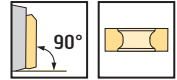

	P	M	K	N	S	H	O
M3255					●●		

Tool	Designation	D _c mm	d ₁ mm	l ₄ mm	L _c mm	Z	kg	No. of indexable inserts	Type
Parallel bore DIN 138 transverse keyway 	★ M3255-050-B22-04-46	50	22	65	46	4	0,5	4 12	XNHX1306 .. R LNHX120604R
	★ M3255-050-B22-05-46	50	22	65	46	5	0,5	5 15	
	★ M3255-063-B27-05-46	63	27	70	46	5	0,9	5 15	
	★ M3255-063-B27-06-46	63	27	70	46	6	0,9	6 18	
	★ M3255-080-B32-05-58	80	32	85	58	5	2,0	5 25	
	★ M3255-080-B32-06-58	80	32	85	58	6	2,0	6 24	

For arbour mounted tools, use longer tightening screws in accordance with ISO 4763.
 The FS2250 coolant nozzle must be secured.
 Bodies and assembly parts are included in the scope of delivery.

★ New addition to the product range

☺☹☹ New addition to the product range

Assembly parts

D _c mm		50–80
	Clamping screw for indexable insert Tightening torque	FS2081 (Torx 15 IP) 4.0 Nm
	Coolant nozzle	FS2250 (SW 1,6)

Accessories

D _c mm		50–80
	Torque screwdriver, analogue	FS2003
	Torque screwdriver, digital Tightening torque	FS2248 1.0–6 Nm
	Interchangeable blade	FS2014 (Torx 15 IP)
	Screwdriver	FS1485 (Torx 15 IP)

Indexable inserts

Designation	r mm	b mm	P			M			K			N		S					
			HC			HC			HC			HC	HW	HC					
			WKP25S	WKP35S	WSP45S	WSM35S	WSM45X	WSP45S	WAK15	WKK25S	WKP25S	WKP35S	WXN15	WK10	WSM35S	WSM45X	WSP45S		
 LNHX120604R-L65T	0,4																		
 XNHX130608R-L65T	0,8	2																	
XNHX130612R-L65T	1,2	2																	
XNHX130616R-L65T	1,6	2																	
XNHX130620R-L65T	2	2																	
XNHX130624R-L65T	2,4	2																	
XNHX130630R-L65T	3	1,4																	
XNHX130632R-L65T	3,2	1,3																	
XNHX130640R-L65T	4	0,5																	

XNHX1306 indexable inserts . . . can only be used as face inserts.

HC = Coated carbide
HW = Uncoated carbide

WALTER SELECT

Stability of machine, workpiece and clamping arrangement

Very good

Good

Moderate

•• Primary application

• Other application

Porcupine milling cutters

M3255 inch

Walter BLAXX



- Full effective design
- Two or four cutting edges per indexable insert, tangential arrangement

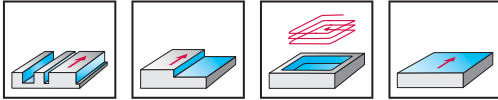
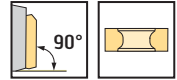

	P	M	K	N	S	H	O
M3255					●●		

Tool	Designation	D _c inches	d ₁ inches	l ₄ inches	L _c inches	Z	kg	No. of indexable inserts	Type
Parallel bore DIN 138 transverse keyway 	★ M3255.051-B19-04-46	2,000	3/4	2,559	1,811	4	0,5	4 12	XNHX1306 .. R LNHX120604R
	★ M3255.051-B19-05-46	2,000	3/4	2,559	1,811	5	0,5	5 15	
	★ M3255.064-B26-05-46	2,500	1,000	2,756	1,811	5	1,0	5 15	
	★ M3255.064-B26-06-46	2,500	1,000	2,756	1,811	6	1,0	6 18	
	★ M3255.076-B31-05-58	3,000	1 1/4	3,346	2,283	5	1,8	5 20	
	★ M3255.076-B31-06-58	3,000	1 1/4	3,346	2,283	6	1,8	6 24	

For arbour mounted tools, use longer tightening screws in accordance with ISO 4763.
 The FS2250 coolant nozzle must be secured.
 Bodies and assembly parts are included in the scope of delivery.

★ New addition to the product range

New addition to the product range

Assembly parts

D _c inches		2,000–3,000
	Clamping screw for indexable insert Tightening torque	FS2081 (Torx 15 IP) 4.0 Nm
	Coolant nozzle	FS2250 (SW 1,6)

Accessories

D _c inches		2,000–3,000
	Torque screwdriver, analogue	FS2003
	Torque screwdriver, digital Tightening torque	FS2248 1.0–6 Nm
	Interchangeable blade	FS2014 (Torx 15 IP)
	Screwdriver	FS1485 (Torx 15 IP)

Indexable inserts

Designation	r mm	b mm	P			M			K			N		S					
			HC			HC			HC			HC	HW	HC					
			WKP25S	WKP35S	WSP45S	WSM35S	WSM45X	WSP45S	WAK15	WKK25S	WKP25S	WKP35S	WXN15	WK10	WSM35S	WSM45X	WSP45S		
 LNHX120604R-L65T	0,4																		
 XNHX130608R-L65T	0,8	2																	
XNHX130612R-L65T	1,2	2																	
XNHX130616R-L65T	1,6	2																	
XNHX130620R-L65T	2	2																	
XNHX130624R-L65T	2,4	2																	
XNHX130630R-L65T	3	1,4																	
XNHX130632R-L65T	3,2	1,3																	
XNHX130640R-L65T	4	0,5																	

XNHX1306 indexable inserts . . . can only be used as face inserts.

HC = Coated carbide
HW = Uncoated carbide

WALTER SELECT

Stability of machine, workpiece and clamping arrangement

Very good

Good

Moderate

•• Primary application

• Other application

Porcupine milling cutters

M4256 / M4257 / M4258



- Half effective teeth
- Two or four cutting edges per indexable insert

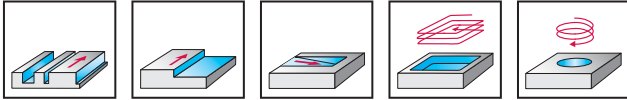
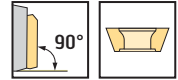

	P	M	K	N	S	H	O
M4256 / M4257 / M4258	●●	●●	●●	●●	●●	●●	●●

Tool	Designation	D _c mm	d ₁ mm	l ₄ mm	l ₁ mm	L _c mm	Z	kg	No. of indexable inserts	Type
ScrewFit 	★ M4256-020-T18-01-27	20	T18	40		27	1	0,1	1 4	LDM . 08T204R SDM . 06T204
	★ M4256-025-T22-02-27	25	T22	40		27	2	0,1	2 8	
	★ M4256-032-T28-02-37	32	T28	50		37	2	0,2	2 12	LDM . 14T308R SDM . 09T308
	★ M4257-040-T36-02-54	40	T36	69		54	2	0,5	2 14	
Shank DIN 1835 B 	★ M4256-020-W20-01-27	20	20	35	86	27	1	0,2	1 4	LDM . 08T204R SDM . 06T204
	★ M4256-025-W25-02-27	25	25	40	97	27	2	0,3	2 8	
	★ M4256-032-W32-02-37	32	32	50	111	37	2	0,6	2 12	LDM . 14T308R SDM . 09T308
	★ M4257-040-W40-02-54	40	40	69	140	54	2	1,1	2 14	
Parallel bore DIN 138 transverse keyway 	★ M4257-050-B22-02-47	50	22	56		47	2	0,4	2 12	LDM . 14T308R SDM . 09T308
	★ M4257-063-B27-03-54	63	27	69		54	3	0,8	3 21	
	★ M4258-080-B32-03-67	80	32	80		67	3	1,4	3 18	LDM . 170408R SDM . 120408
	★ M4258-100-B40-04-77	100	40	80		77	4	2,4	4 28	

For arbour mounted tools, use longer tightening screws in accordance with ISO 4763.
Bodies and assembly parts are included in the scope of delivery.

★ New addition to the product range

Assembly parts		LDM . 08T204R SDM . 06T204	LDM . 14T308R SDM . 09T308	LDM . 170408R SDM . 120408
	Type Clamping screw for indexable insert Tightening torque	FS2084 (Torx 7 IP) 0.9 Nm	FS2266 (Torx 10 IP) 2.0 Nm	FS1453 (Torx 15 IP) 3.5 Nm

Accessories		LDM . 08T204R SDM . 06T204	LDM . 14T308R SDM . 09T308	LDM . 170408R SDM . 120408
	Torque screwdriver, analogue	FS2001	FS2003	FS2003
	Torque screwdriver, digital Tightening torque		FS2248 1.0–6 Nm	FS2248 1.0–6 Nm
	Interchangeable blade	FS2011 (Torx 7 IP)	FS2268 (Torx 10 IP)	FS2014 (Torx 15 IP)
	Screwdriver	FS2088 (Torx 7 IP)	FS2267 (Torx 10 IP)	FS1485 (Torx 15 IP)

Indexable inserts

Designation	r mm	b mm	P		M		K			S			O	
			HC		HC		HC			HC			HF	
			WKP25S	WKP35S	WSP45S	WSM35S	WSM45X	WSP45S	WAK15	WKK25S	WKP25S	WKP35S	WSM35S	WSM45X
	LDMT08T204R-D51	0,4	0,8	☒	☒	☒								
	LDMT08T204R-D57	0,4	0,8	☒	☒	☒								
	LDMT08T204R-F57	0,4	0,8	☒	☒	☒								
	LDMT14T308R-D51	0,8	1,2	☒	☒	☒								
	LDMT14T308R-D57	0,8	1,2	☒	☒	☒								
	LDMT14T308R-F57	0,8	1,2	☒	☒	☒								
	LDMW08T204R-A57	0,4	0,8	☒	☒									
	LDMW14T308R-A57	0,8	1,2	☒	☒									
	LDMT170408R-D51	0,8	1,6	☒	☒	☒								
	LDMT170408R-D57	0,8	1,6	☒	☒	☒								
	LDMT170408R-F57	0,8	1,6	☒	☒	☒								
	LDMW170408R-A57	0,8	1,6	☒	☒									
	SDMT06T204-D51	0,4		☒	☒	☒								
	SDMT06T204-D57	0,4		☒	☒	☒								
	SDMT06T204-F57	0,4		☒	☒	☒								
	SDMW06T204-A57	0,4		☒	☒									
	SDMT09T308-D51	0,8		☒	☒	☒								
	SDMT09T308-D57	0,8		☒	☒	☒								
	SDMT09T308-F57	0,8		☒	☒	☒								
	SDMW09T308-A57	0,8		☒	☒									
	SDMT120408-D51	0,8		☒	☒	☒								
	SDMT120408-D57	0,8		☒	☒	☒								
	SDMT120408-F57	0,8		☒	☒	☒								
	SDMW120408-A57	0,8		☒	☒									

HC = Coated carbide
HF = Uncoated fine-grain carbide

WALTER SELECT

Stability of machine, workpiece and clamping arrangement

☺
Very good

☹
Good

☹
Moderate

●● Primary application

● Other application

Porcupine milling cutters

M4256 / M4257 / M4258 inch



- Half-effective teeth
- Two or four cutting edges per indexable insert

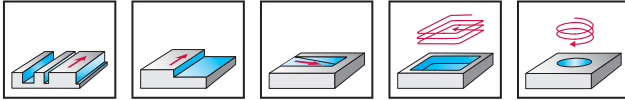
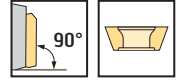

	P	M	K	N	S	H	O
M4256 / M4257	●	●	●	●	●		
M4258	●	●	●	●	●		

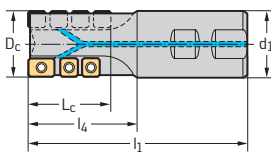
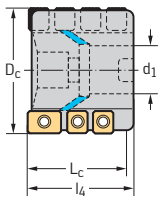
Tool	Designation	D _c inches	d ₁ inches	l ₄ inches	l ₁ inches	L _c inches	Z	kg	No. of indexable inserts	Type
Shank DIN 1835 B 	★ M4256.019-W19-01-27	0,750	3/4	1,378	3,409	1,063	1	0,2	1 4	LDM . 08T204R SDM . 06T204
	★ M4256.026-W26-02-27	1,000	1,000	1,575	3,856	1,063	2	0,3	2 8	
	★ M4256.031-W31-02-37	1,250	1 1/4	1,969	4,250	1,457	2	0,5	2 12	
	★ M4257.038-W38-02-54	1,500	1 1/2	2,750	5,438	2,126	2	0,9	2 14	
Parallel bore DIN 138 transverse keyway 	★ M4257.051-B19-02-47	2,000	3/4	2,248		1,850	2	0,4	2 12	LDM . 14T308R SDM . 09T308
	★ M4257.064-B26-03-54	2,500	1,000	2,748		2,126	3	0,9	3 21	
	★ M4258.076-B31-03-67	3,000	1 1/4	3,150		2,638	3	1,2	3 18	LDM . 170408R SDM . 120408
	★ M4258.102-B38-04-77	4,000	1 1/2	3,150		3,031	4	2,5	4 28	

For arbour mounted tools, use longer tightening screws in accordance with ISO 4763.
Bodies and assembly parts are included in the scope of delivery.

★ New addition to the product range

Assembly parts		LDM . 08T204R SDM . 06T204	LDM . 14T308R SDM . 09T308	LDM . 170408R SDM . 120408
	Type Clamping screw for indexable insert Tightening torque	FS2084 (Torx 7 IP) 0.9 Nm	FS2266 (Torx 10 IP) 2.0 Nm	FS1453 (Torx 15 IP) 3.5 Nm

Accessories		LDM . 08T204R SDM . 06T204	LDM . 14T308R SDM . 09T308	LDM . 170408R SDM . 120408
	Torque screwdriver, analogue	FS2001	FS2003	FS2003
	Torque screwdriver, digital Tightening torque		FS2248 1.0–6 Nm	FS2248 1.0–6 Nm
	Interchangeable blade	FS2011 (Torx 7 IP)	FS2268 (Torx 10 IP)	FS2014 (Torx 15 IP)
	Screwdriver	FS2088 (Torx 7 IP)	FS2267 (Torx 10 IP)	FS1485 (Torx 15 IP)

Indexable inserts

Designation	r mm	b mm	P		M		K			S			O	
			HC		HC		HC			HC			HF	
			WKP25S	WKP35S	WSP45S	WSM35S	WSM45X	WSP45S	WAK15	WKK25S	WKP25S	WKP35S	WSM35S	WSM45X
	LDMT08T204R-D51	0,4	0,8	☒	☒	☒								
	LDMT08T204R-D57	0,4	0,8	☒	☒	☒								
	LDMT08T204R-F57	0,4	0,8	☒	☒	☒								
	LDMT14T308R-D51	0,8	1,2	☒	☒	☒								
	LDMT14T308R-D57	0,8	1,2	☒	☒	☒								
	LDMT14T308R-F57	0,8	1,2	☒	☒	☒								
	LDMW08T204R-A57	0,4	0,8	☒	☒									
	LDMW14T308R-A57	0,8	1,2	☒	☒									
	LDMT170408R-D51	0,8	1,6	☒	☒	☒								
	LDMT170408R-D57	0,8	1,6	☒	☒	☒								
	LDMT170408R-F57	0,8	1,6	☒	☒	☒								
	LDMW170408R-A57	0,8	1,6	☒	☒									
	SDMT06T204-D51	0,4		☒	☒	☒								
	SDMT06T204-D57	0,4		☒	☒	☒								
	SDMT06T204-F57	0,4		☒	☒	☒								
	SDMW06T204-A57	0,4		☒	☒									
	SDMT09T308-D51	0,8		☒	☒	☒								
	SDMT09T308-D57	0,8		☒	☒	☒								
	SDMT09T308-F57	0,8		☒	☒	☒								
	SDMW09T308-A57	0,8		☒	☒									
	SDMT120408-D51	0,8		☒	☒	☒								
	SDMT120408-D57	0,8		☒	☒	☒								
	SDMT120408-F57	0,8		☒	☒	☒								
	SDMW120408-A57	0,8		☒	☒									

HC = Coated carbide
HF = Uncoated fine-grain carbide

WALTER SELECT

Stability of machine, workpiece and clamping arrangement

☺
Very good

☹
Good

☹
Moderate

•• Primary application

• Other application

Cutting data for shoulder and slot milling with full effective porcupine milling cutters (M3255)

Material group	Overview of the main material groups and code letters		Brinell hardness HB	Tensile strength R_m N/mm ²	Machining group ¹	= Cutting data for wet machining = Dry machining is possible.		Cutting material grades					
								Starting values for cutting speed v_c [m/min]					
								HC		WSP45S		WSM45X	
								a_e / D_c^*		a_e / D_c^*		a_e / D_c^*	
				1/2		1/5		1/1		1/5			
P	Non-alloyed steel	C ≤ 0.25%	Annealed	125	430	P1	●	●●					
		C > 0.25 ... ≤ 0.55%	Annealed	190	640	P2	●	●●					
		C > 0.25 ... ≤ 0.55%	Heat-treated	210	710	P3	●	●●					
		C > 0.55%	Annealed	190	640	P4	●	●●					
		C > 0.55%	Heat-treated	300	1010	P5	●	●●					
	Low-alloyed steel	Free cutting steel (short-chipping)	Annealed	220	750	P6	●	●●					
		Annealed		175	590	P7	●	●●					
		Heat-treated		285	960	P8	●	●●					
		Heat-treated		380	1280	P9	●	●●					
		Heat-treated		430	1480	P10	●	●●					
	High-alloyed steel and high-alloyed tool steel	Annealed		200	680	P11	●	●●					
		Hardened and tempered		300	1010	P12	●	●●					
		Hardened and tempered		380	1280	P13	●	●●					
	Stainless steel	Ferritic/martensitic, annealed		200	680	P14	●	●●					
		Martensitic, heat-treated		330	1110	P15	●	●●					
M	Stainless steel	Austenitic, quench hardened		200	680	M1	●●	●					
		Austenitic, precipitation hardened (PH)		300	1010	M2	●●	●					
		Austenitic/ferritic, duplex		230	780	M3	●●	●					
K	Malleable cast iron	Ferritic		200	400	K1	●	●●					
		Pearlitic		260	700	K2	●	●●					
	Grey cast iron	Low tensile strength		180	200	K3	●	●●					
		High tensile strength/austenitic		245	350	K4	●	●●					
	Cast iron with spheroidal graphite	Ferritic		155	400	K5	●	●●					
		Pearlitic		265	700	K6	●	●●					
	GGV (CGI)		230	400	K7	●	●●						
N	Aluminium wrought alloys	Cannot be hardened		30	–	N1	●●						
		Hardenable, hardened		100	340	N2	●●						
	Cast aluminium alloys	≤ 12% Si, cannot be hardened		75	260	N3	●●						
		≤ 12% Si, hardenable, hardened		90	310	N4	●●						
		> 12% Si, cannot be hardened		130	450	N5	●●						
	Magnesium alloys ³		70	250	N6	●●							
	Copper and copper alloys (bronze/brass)	Non-alloyed, electrolytic copper		100	340	N7	●●						
		Brass, bronze, red brass		90	310	N8	●●						
		Cu-alloys, short-chipping		110	380	N9	●●						
		High-strength, Ampco		300	1010	N10	●●						
S	Heat-resistant alloys	Fe-based	Annealed	200	680	S1	●●		50	55	60	65	
			Hardened	280	940	S2	●●		35	40	40	45	
		Ni or Co base	Annealed	250	840	S3	●●		40	45	45	50	
			Hardened	350	1180	S4	●●		25	30	25	30	
			Cast	320	1080	S5	●●		30	35	40	40	
	Titanium alloys	Pure titanium		200	680	S6	●●		50	65	60	75	
		α and β alloys, hardened		375	1260	S7	●●		30	35	35	40	
		β alloys		410	1400	S8	●●		25	30	30	35	
	Tungsten alloys		300	1010	S9	●●		30	35	35	40		
	Molybdenum alloys		300	1010	S10	●●		25	30	30	35		
H	Hardened steel	Hardened and tempered		50 HRC	–	H1		●●					
		Hardened and tempered		55 HRC	–	H2		●●					
		Hardened and tempered		60 HRC	–	H3		●●					
	Hardened cast iron	Hardened and tempered		55 HRC	–	H4		●●					
O	Thermoplastics	Without abrasive fillers				O1	●●	●					
	Thermosetting plastics	Without abrasive fillers				O2	●●	●					
	Plastic, glass-fibre-reinforced	GFRP				O3							
	Plastic, carbon-fibre-reinforced	CFRP				O4							
	Plastic, aramid-fibre-reinforced	AFRP				O5							
	Graphite (technical)		80 Shore			O6		●●					

- Recommended application (the specified cutting data is regarded as starting values for the recommended application)
- Possible application, reduce cutting data by 30–50% (increase by approx. 70–80% for ISO M)

¹ The classification of the machining groups can be found in the Walter General Catalogue 2012 from page H 8 onwards.

* $a_e / D_c = 1 / 10$, $v_c = 10\%$ higher than 1 / 5

³ Water-miscible coolants must not be used when machining magnesium alloys.

Feed determination (starting values)

Porcupine milling cutters

The specified feed rates are average recommended values.
For special applications, adjustment is recommended.

Cutter type		M3255	M4256	M4257	M4258
Material group	<p>Feed per tooth f_{z0} for $a_e = D_c$ $a_p = a_{p\ max} = L_c$</p>	Walter BLAXX			
	Lead angle κ	90°	90°	90°	90°
	Page	98	102	102	102
	Tool \emptyset or \emptyset range (mm)	f_{z0} [mm] 50–80	f_{z0} [mm] 20–32	f_{z0} [mm] 40–63	f_{z0} [mm] 80–100
	Maximum cutting data $a_{p\ max} = L_c$ (mm)	46–58	27–37	47–54	67–77
	P	Non-alloyed steel ¹ Low-alloyed steel High-alloyed steel and tool steel Stainless steel		0,10 0,08 0,08 0,06	0,15 0,12 0,12 0,08
M	Stainless steel ²		0,06	0,08	0,10
K	Malleable cast iron Grey cast iron Cast iron with spheroidal graphite GGV (CGI)		0,12 0,10 0,10 0,10	0,20 0,15 0,15 0,15	0,25 0,20 0,20 0,20
N	Aluminium wrought alloys Cast aluminium alloys Magnesium alloys Copper and copper alloys (bronze/brass)				
S	Heat-resistant alloys Titanium alloys Tungsten alloys Molybdenum alloys	0,15 0,15 0,15 0,15	0,06 0,06 0,06 0,06	0,10 0,10 0,10 0,10	0,10 0,10 0,10 0,10
H	Hardened steel Hardened cast iron				
O	Thermoplastics Plastic, carbon-fibre-reinforced Graphite (technical)				
Indexable insert types		XNHX1306.. LNHX1206..	SD .. 06T2 ... LD .. 08T2 ...	SD .. 09T3 ... LD .. 14T3 ...	SD .. 1204 ... LD .. 1704 ...
Correction factor K_{a_e}			1.0**	1.0**	-
$a_e / D_c =$		1/1–1/2	1,1	1,1	1,1
		1/5	1,2	1,2	1,2
For the feed per tooth depending on the ratio of cut width a_e to cutter diameter D_c		1/10	1,3	1,3	1,3
		1/20	1,5		
		1/50			
Correction factor K_{a_p}			1,0	1,6	1,6
for the feed per tooth depending on the cutting depth a_p		$a_p =$	1,0	1,0	1,6
		6	1,0	1,6	1,6
		9	1,0	1,6	1,6
		12	1,0	1,6	1,6
		$0,5 \times D_c$	1,0	1,0	1,0
		$0,75 \times D_c$	0,8	0,8	0,8
		$1 \times D_c$	0,7	0,7	0,7
$f_z = f_{z0} \cdot K_{a_e} \cdot K_{a_p}$		$a_{p\ max} = L_c$	0,5*	0,5*	0,5*

¹ and cast steel

² and austenitic/ferritic

* only possible if $a_p < 0,75 \times D_c$

** only with $a_e/D_c < 1/5$

Tightening screws for shell end mill arbors

When using face mill adaptors A150, A155 and AK155 in combination with porcupine milling cutters and ramping milling cutters with cylindrical bores and transverse keyway in accordance with DIN 138, the tightening screw of the adaptor must be replaced.

Designation	Tightening screw for adaptor*
M2131-040-B16-03-15	M8 × 40 (SW6)
M2131-050-B22-04-15	M10 × 35 (SW8)
M2131-063-B22-05-15	M10 × 35 (SW8)
M2131-080-B27-05-15	M12 × 40 (SW10)
M2131-050-B22-03-20	M10 × 40 (SW8)
M2131-063-B22-04-20	M10 × 35 (SW8)
M3255-050-B22-04-46	M10 × 45 (SW8)
M3255-050-B22-05-46	M10 × 45 (SW8)
M3255-063-B27-05-46	M12 × 50 (SW10)
M3255-063-B27-06-46	M12 × 50 (SW10)
M3255-080-B32-05-58	M16 × 65 (SW14)
M3255-080-B32-06-58	M16 × 65 (SW14)
M4257-050-B22-02-47	M10 × 45 (SW8)
M4257-063-B27-03-54	M12 × 70 (SW10)
M4258-080-B32-03-67	M16 × 90 (SW14)
M4258-100-B40-04-77	M20 × 80 (SW17)

* Cap screw ISO 4762 (12.9)

Application information for M4256/M4257/M4258

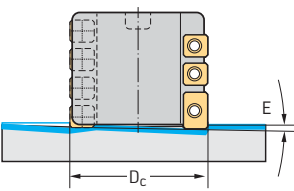
Ramping	Maximum feed angle E [°]			
	Dc [mm]	SD .. 06T2 .. LD .. 08T2 ..	SD .. 09T3 .. LD .. 14T3 ..	SD .. 1204 .. LD .. 1704 ..
	20	1		
	25	2		
	32	1,5		
	40		1,4	
	50		1	
	63		0,5	
	80			0,5
	100			0,4

The Walter product lines – expertise to the power of three.

All Walter tools are characterised by maximum precision and process reliability.

You can create real added value by finding a product range which precisely meets all of your requirements. With three product lines in its premium segment, Walter has the solution to match your requirements.

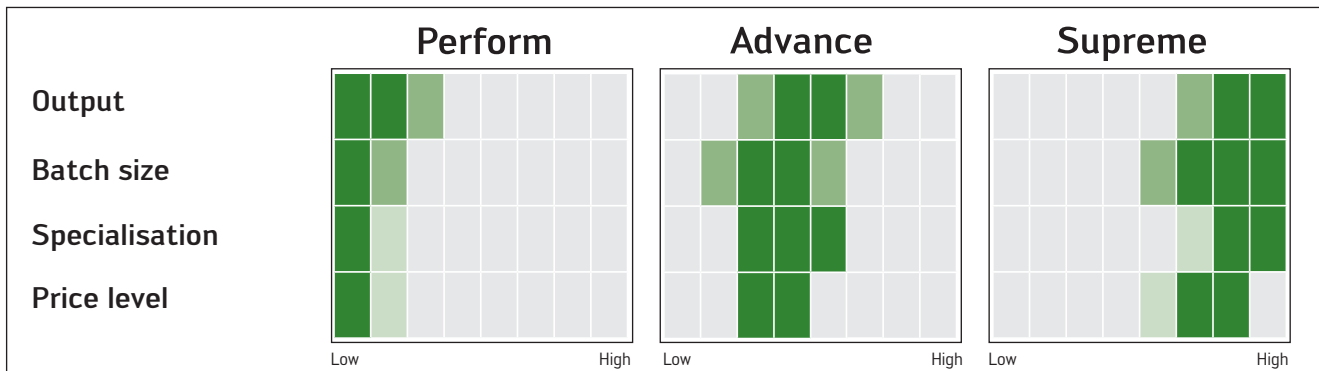
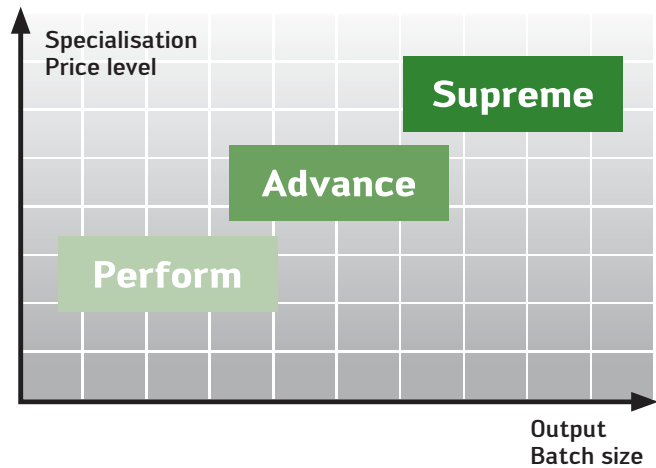

Supreme

Within the Supreme line, you will find tools with optimised machining qualities. These tools are always the first choice wherever high cutting speeds and long tool life for processing large batch sizes are required. The tools from the Supreme line are designed for machining very specific material groups, and often far exceed the performance of comparable tools.

Advance

Are you looking to strike the ideal balance between the most cost-effective production possible and long tool life? The strengths of the tools in the Advance line come into play best in series production applications of medium batch sizes. They offer three key benefits: Modest investment costs, excellent performance data and a wide range of different models.

Perform

The tools in the Perform line help you to ensure excellent profitability and cover an impressively wide range of applications. They are ideal for use with a wide variety materials, for processing small and medium batch sizes.

Reconditioning to the original manufacturer quality really pays off.

The Reconditioning Service from Walter Multiply makes a significant contribution towards lowering your production costs. This service can provide you with Walter Titex and Walter Prototyp tools that are as good as new, to the original manufacturer quality standard and all at an attractive price-performance ratio.

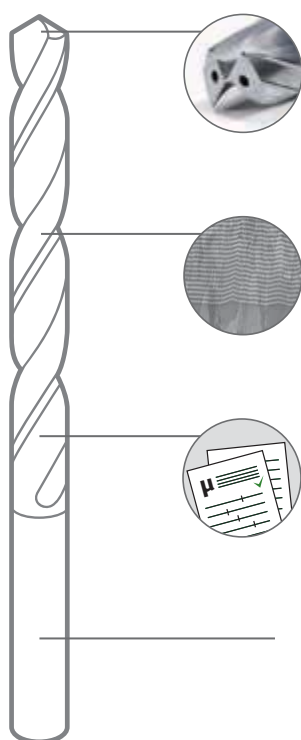

ORIGINAL GEOMETRIES

Cutting edge geometries are complex. During reconditioning, Walter calls upon its extensive engineering competence to return them to their original condition.

ORIGINAL COATING

When it comes to tool performance, the coating is key. Only Walter uses the original coating process during reconditioning.

ORIGINAL TOLERANCES

These tolerances and marks of quality are just as important for a reconditioned tool as for a newly manufactured tool. To achieve this, we only use the most up-to-date measuring equipment.

RECONDITIONING RANGE

- Solid carbide drills and milling cutters
- Solid carbide special boring tools and special milling tools
- High-performance solid carbide reaming tools
- Solid carbide thread milling cutters



OUR MARK OF 100% QUALITY

Look out for the "Original Walter Quality" label. This label indicates that a tool has been reconditioned to original manufacturer quality. It even appears in the ordering documents, enabling you to see the tools for which we recommend our Reconditioning Service.

50% LOWER COSTS

Tools are often disposed of far too early, even though the Walter Reconditioning Service can restore the tool a number of times to original manufacturer quality. You can benefit from reduced costs, reliable production processes and consistent tool life by having your tools reconditioned at our Reconditioning Center, which is available worldwide. It could save you up to 50% on your tool costs!

Find out more at: walter-tools.com

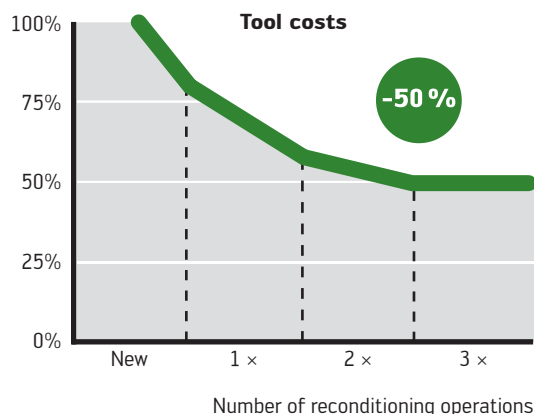

Index of Product pages

Designation	Page	Designation	Page	Designation	Page
A		M		R	
A6493TTP.....	38	M2131.....	96	RCMT.....	17
C		M3255.....	98	S	
CCMT.....	15	M4002.....	92	SCMT.....	18
CNMG.....	10	M4256.....	102	SNMG.....	12
D		M4257.....	102	SX.....	23
DC150.....	40	M4258.....	102	T	
DC170.....	43	MC122.....	76	TC115.....	55
DCMT.....	16	MC129.....	75	TC216.....	54
DNMG.....	11	MC321.....	69	TCMT.....	19
G		MC324.....	71	TNMG.....	13
G1011.....	24	MC326.....	65	V	
G1041.....	28	MC341.....	63	VBMT.....	20
G1511.....	26	MC413.....	79	VCMT.....	20
G2042.....	29	MC416.....	77	VNMG.....	14
GX.....	22	MC500.....	81	W	
H		MC501.....	82	WCMT.....	21
H4135217.....	64	MC502.....	82	WNMG.....	14
H4137217.....	64	MC503.....	83	X	
L		MC504.....	83	XNGX.....	91
LCMX.....	49	MC716.....	73	XNHX.....	90
LNHX.....	90	P			
		P284.....	48		
		P600.....	45		

3 ways of discovering our innovations.



There for you in person, on site, worldwide.

You can contact us by phone, fax or e-mail. The contact details for your local contact partner can be found on our website at: walter-tools.com

Online – via smartphone, tablet or PC.

At walter-tools.com, you can access and order your Walter products quickly and conveniently online. The benefit for you: Direct access from any terminal device, displayed in an optimised form, at any time.

New: You can now use our wear optimisation app to accurately detect and reduce wear. Try it out now – it is available online or for download on our website.



<http://goo.gl/wo8bqk>



<http://goo.gl/rB9zKw>

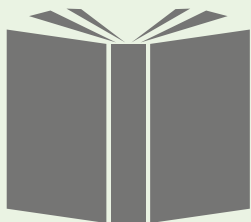

The “classic” way, ordering from our printed catalogues.

You can find our complete range of tools here:

- General Catalogue 2012
- Supplementary Catalogue 2013/2014
- Product Innovations 14-2 and 15-1

New: Product innovations 16-1

Walter AG

Derendinger Straße 53, 72072 Tübingen
Postfach 2049, 72010 Tübingen
Germany

walter-tools.com

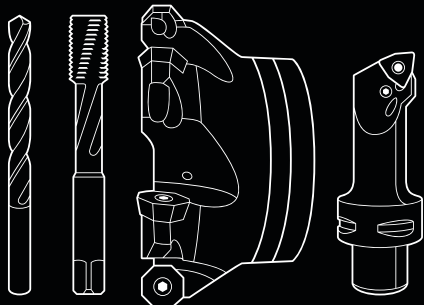

Walter GB Ltd.

Bromsgrove, England
+44 (1527) 839 450, service.uk@walter-tools.com

Walter Kesici Takımlar Sanayi ve Ticaret Ltd. Şti.

Istanbul, Türkiye
+90 (0) 216 528 1900 Pbx, service.tr@walter-tools.com

Walter Wuxi Co. Ltd.

Wuxi, Jiangsu, P.R. China
+86 (510) 853 72199, service.cn@walter-tools.com

Walter AG Singapore Pte. Ltd.

+65 6773 6180, service.sg@walter-tools.com

Walter Korea Ltd.

Anyang-si Gyeonggi-do, Korea
+82 (31) 337 6100, service.kr@walter-tools.com

Walter Tools India Pvt. Ltd.

Pune, India
+91 (20) 3045 7300, service.in@walter-tools.com

Walter (Thailand) Co., Ltd.

Bangkok, 10120, Thailand
+66 2 687 0388, service.th@walter-tools.com

Walter Malaysia Sdn. Bhd.

Selangor D.E., Malaysia
+60 (3) 5624 4265, service.my@walter-tools.com

Walter Japan K.K.

Nagoya, Japan
+81 (52) 533 6135, service.jp@walter-tools.com

Walter USA, LLC

Waukesha WI, USA
+1 800-945-5554, service.us@walter-tools.com

Walter Canada

Mississauga, Canada
service.ca@walter-tools.com