

AUTOMATED DEBURRING WITH BRUSHES

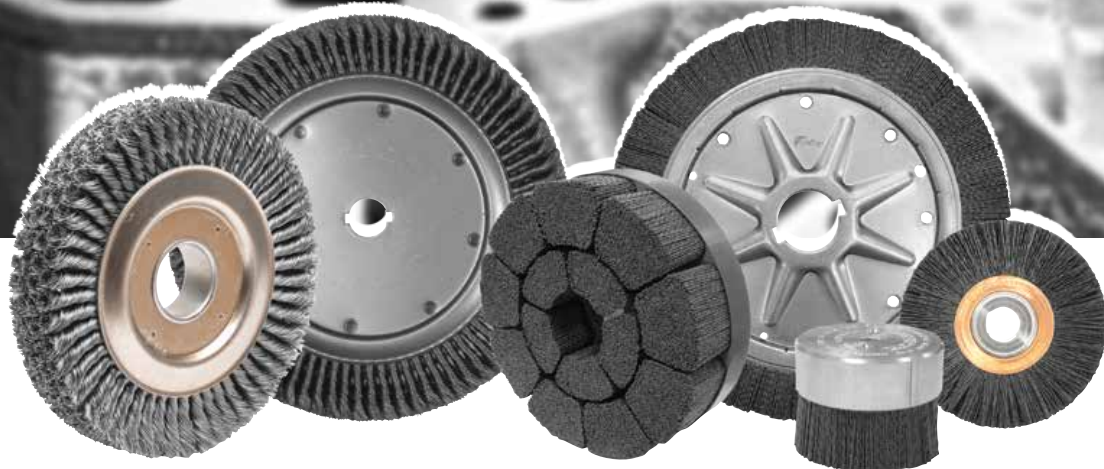
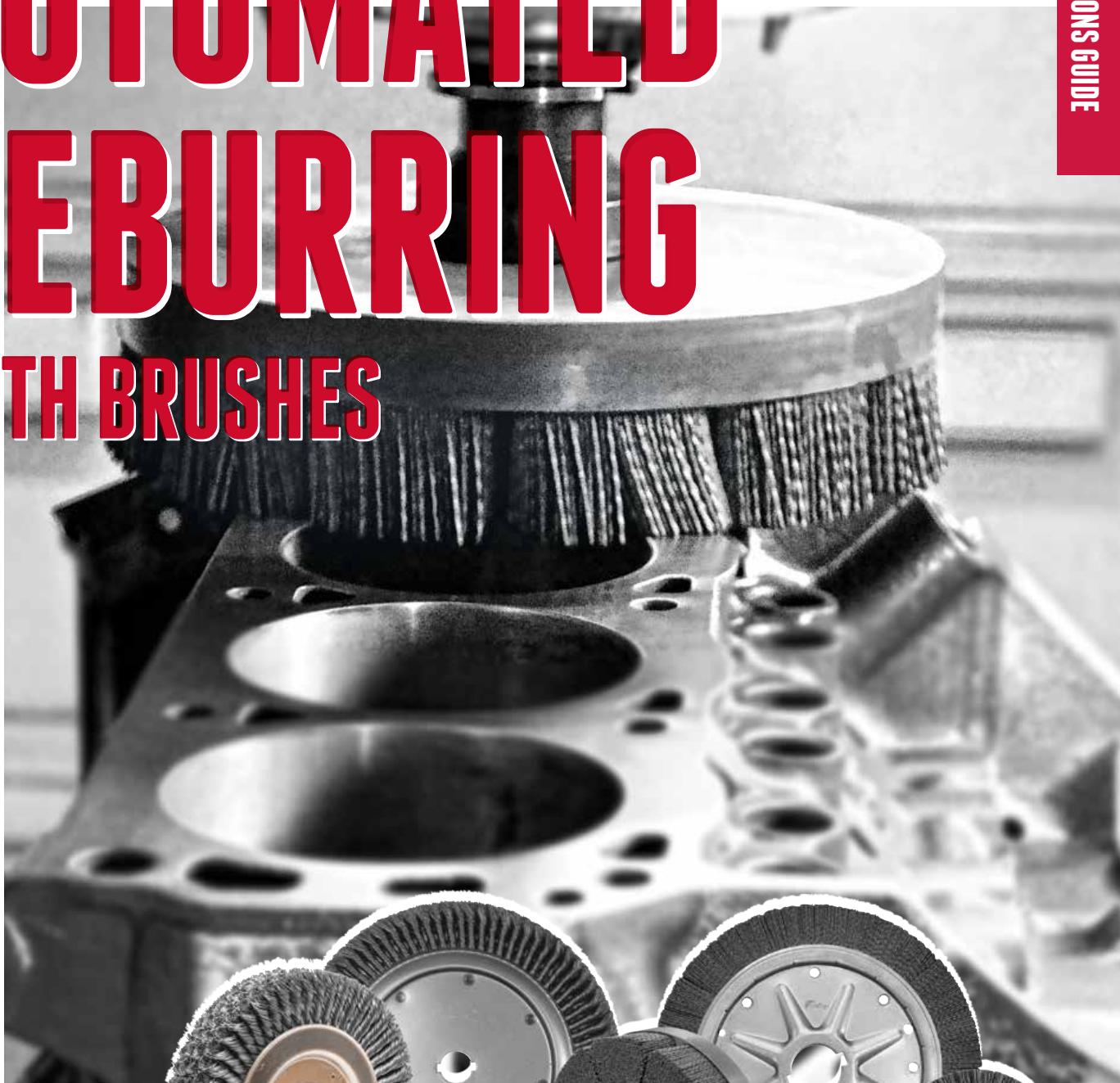

An Informative Guide to Automated Deburring

AUTOMATED DEBURRING WITH BRUSHES

Wire brushes and nylon abrasive brushes have been employed successfully for many years as cost-effective solutions to a wide variety of deburring applications. Their ability to quickly remove burrs without changing part dimensions has been understood for decades. The implementation of these products in automated deburring environments has become extremely common in recent years.

The following pages contain basic information on automated brush deburring techniques. For more information and to schedule a consultation visit: www.weilerabrasives.com/wps. To discuss specific requirements with a specialist call: 800-835-9999. Seemingly subtle differences between applications and process objectives can have a meaningful impact on system design elements and brush selection.

BURR CLASSIFICATION

The pictures below show Weiler's burr classification system which qualitatively describes burr types produced by common metalworking processes.

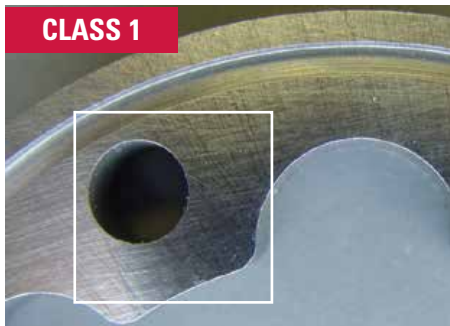

Microburrs can only be observed using magnification. To the unaided eye, they appear as sharp edges. Grinding operations are a common source of this type of burr.



Feather burrs are readily visible without magnification and are characterized by extremely thin roots. They can be removed with a tip of a pencil.



Burrs in this group are well-attached, but relatively small in size. Despite their size, significant mechanical energy must be applied to remove them.

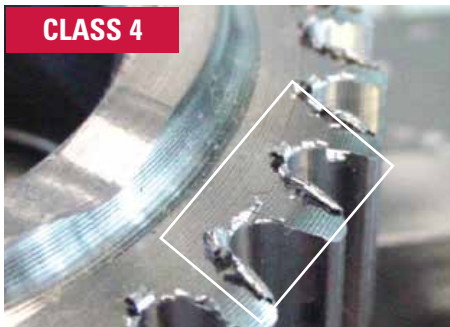

Like Class 3 burrs, the burrs in this class are well-attached. The primary difference is size and root thickness.

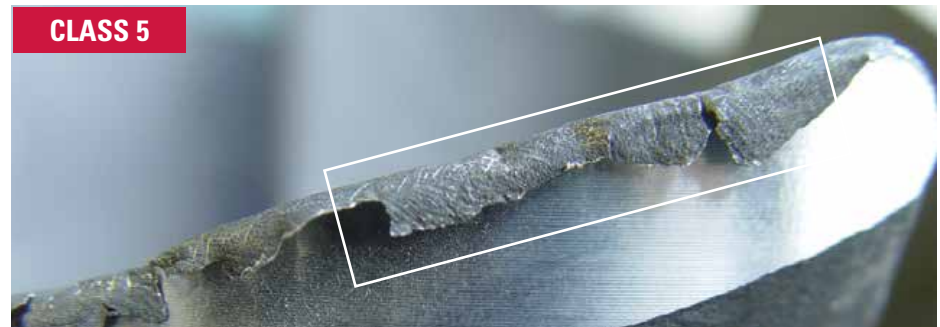

Class 5 burrs are very large with thick, rigid roots. Burrs in this class are different than conventional burrs because they are comprised of displaced base material which is still fully-attached to the parent part. Brushes can sometimes remove Class 5 burrs, but often a stock removal operation such as grinding or machining is required for complete removal.

WIRE BRUSHING

Like blasting, wire brushing removes burrs through the impact of millions of high-speed particles. An 8" wheel brush turning at 3450 RPM delivers more than 10 million wire tips to the work surface per minute. (Each of these wire tips has a hardness of approximately 60 Rc and a striking velocity of 82 MPH.)

The analogy of wire brushing to blasting extends to factors affecting brush aggression. A blasting operation can be made more aggressive by increasing particle velocity and volume. Similarly, increasing brush speed improves aggression by raising wire tip velocity and the number of impacts per second.

Since the tips of the wires (not the sides) are the primary working elements of a wire brush, increasing the load (pressure applied) does not increase aggression because wire tip contact is reduced. In addition to increasing surface speed, wire brush aggression can also be improved by increasing wire point density and filament stiffness.

Because **wire brushes deburr through an impact-driven process, burrs can be removed very quickly.** With the optimal operating parameters, an edge can normally be deburred thoroughly in a few seconds. Dwell times beyond a few seconds are unlikely to produce improved results.

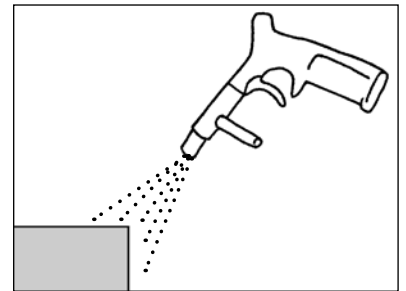
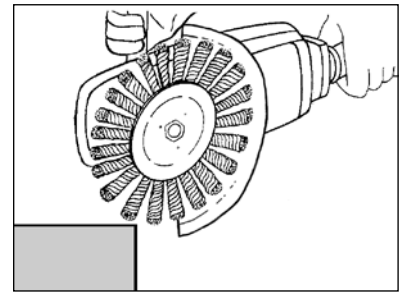

Wire brushing is analogous to blasting. Both processes deliver millions of high-speed particles to the target surface, thereby separating burrs from the base material. Due to the striking action of wire brushes, high operating speeds and low pressures are critical to successful operation.

NYLOX® BRUSHING

Nylox nylon abrasive filament brushes are best understood by thinking of each brush as a collection of flexible files. Each filament is impregnated with abrasive grains which act like teeth on a file. A 14" wheel brush rotating at 900 RPM with a depth of interference (DOI) of 1/2" brings more than 20 miles of filing surface over the work surface each minute.

Because Nylox brushes perform deburring primarily by filing rather than striking, dwell time is a critical variable affecting their performance. The burred edge must be exposed to the brush for sufficient time for the filaments to remove the burr through abrasion. Brush speed is also critical. High brush speeds prevent the sides of the brush filaments from smoothly wiping across the part edge and often reduce the effectiveness of the brushes.

A wide variety of abrasive nylon fill materials are available which offer differing performance characteristics. These filaments may contain abrasives such as aluminum oxide, silicon carbide, ceramic, and diamond for special applications.

The flexible nature Nylox brushes causes the cutting action to be "edge selective". Since the filaments deflect away from a broad surface and absorb a large portion of the applied load, **Nylox brushes tend not to alter the overall dimensions and geometry of a part** or to generate the same prominent scratch-line finish as a conventional abrasive product of the same grit size.



A magnified view of Nylox filaments shows the abrasive grains which are impregnated in the nylon carrier. During operation, burrs are removed by an abrading action in which filaments act like files. Unlike wire brushes, Nylox brushes need to be run at low speeds and significant pressures for maximum effectiveness.

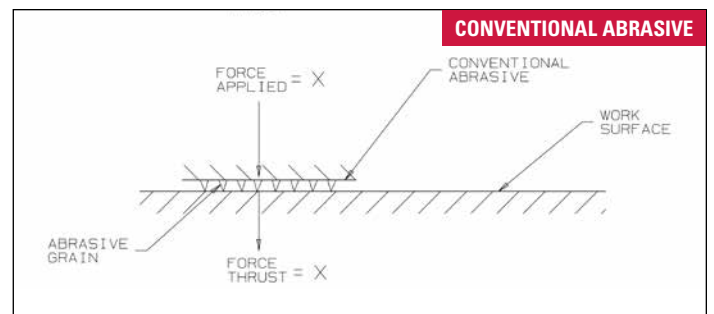
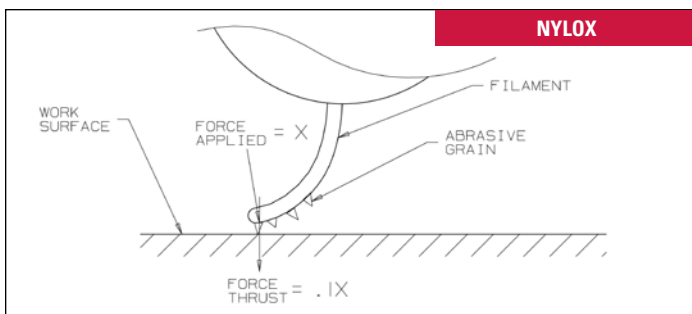

Although Nylox brushes contain relatively large abrasive grains, they do not produce deep scratches like conventional abrasives because the cutting force is much lower.

APPLICATION TYPES

Brush deburring operations fall into four generic types. The application parameters listed below are only guidelines. Subtle differences in part geometry, burr size and burr location may necessitate different parameters.

EDGE DEBURRING

Work Material:	Cast iron
Brush Type:	6" diameter disc brush
Filament Type:	.043/120 CG Nylox filament
Spindle Speed:	1,250 RPM
Depth of Interference:	.080"
Feed Rate:	50" per minute
Brush Rotation Direction:	Opposite rotation
Equipment Used:	CNC
Coolant:	Flood with coolant
Burr Class:	Class Three

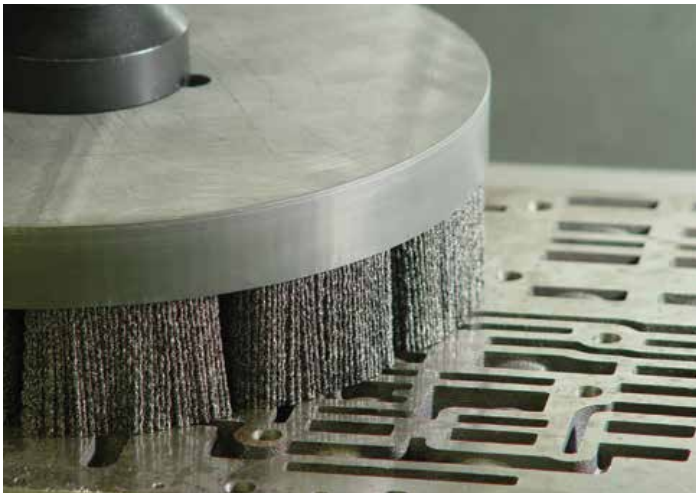

Disc brushes are ideal for deburring parts with numerous burred edges which lie on the same plane.

Many face-milled parts have numerous burrs (commonly Class Three) which lie on the same plane. The valve body (pictured) is a good example of a complicated part geometry with a face-milled burr configuration. Prior to implementing an in-machine deburring solution with brushes, this part was being deburred manually. By including brush deburring within the machining cycle, the secondary operation and associated hand-work were eliminated. The elimination of hand-work resulted in a reduction in scrap and rework, which made the manual process extremely expensive.

SURFACE FINISHING AND DEBURRING

Brush Type:	14" wheel brushes ganged to achieve a 16" brush face
Filament Type:	.022"/320 grit crimped Nylox
Spindle Speed:	800 RPM
Depth of Interference:	1"
Cycle Time:	25 seconds
Brush Rotation Direction:	Opposite camshaft rotation
Equipment Used:	Custom
Coolant:	Required to achieve surface finish
Burr Class:	Class One



The conformability of Nylox wheels makes them excellent tools for deburring and finishing highly contoured parts like forged camshafts.

Ground and machined parts frequently have surface finish requirements which necessitates secondary finishing operations. Nylox brushes are often ideal for these applications because they deburr and finish in the same operation.

The application at above involves finishing/deburring camshafts. The objective of the application is to improve the surface finish on the lobes of the shaft and remove any residual burrs (Class One) on the edges of the lobes. With this type of operation, surface finishes of under 20 microinches Ra can be achieved. In addition, the part can be finished without changing dimensional features which are controlled to extremely tight tolerances.

Nylox brushes can deburr and finish simultaneously because their aggressiveness is driven by pressure. On edges, the cutting pressure is relatively high and facilitates burr removal. However, pressure drops significantly as the filaments move on to flat surfaces. The filaments cut less aggressively on flat surfaces and improve surface finish by reducing asperity peaks.

BORE DEBURRING AND FINISHING

Work Material:	Cast steel
Brush Type:	3" Bore-Rx™
Filament Type:	0.043"/120 grit crimped Nylox
Spindle Speed:	1500 RPM
Depth of Interference:	.080"
Feed Rate:	39" per minute
Brush Rotation Direction:	Opposite rotation of cutting tool
Equipment Used:	CNC machining center
Coolant:	Required to achieve surface finish
Burr Class:	Class Two

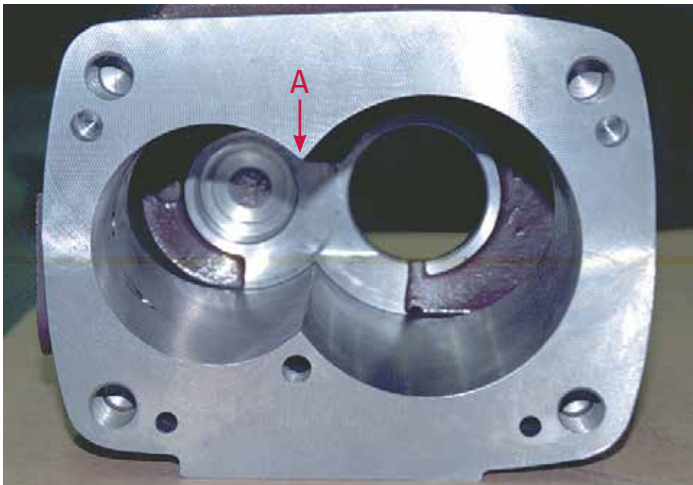

Screw compressor housings have adjoining bores which must be deburred to ensure successful operation. Small Nylox wheel brushes can be used for this application.

Parts with bores often contain machined features with small burrs. These features can be cross-holes, narrow grooves, stepped bore diameters, or adjoining bores. The compressor housing (pictured) is an example of a part with adjoining bores. On this part, a Class Two burr was present on edge "A". This burr was removed in the CNC machining center by interpolating a Burr-Rx brush around the circumference of each bore. The brushes also reduced the surface finish of the bore to less than 35 microinches Ra.

The primary advantages of in-machine deburring are improved part consistency and simplified part flow. In addition to improving the economics of the deburring operation, eliminating repetitious hand deburring also reduces the risk of muscular-skeletal disorders, including carpal tunnel syndrome.

EDGE RADIUSING

Brush Type:	14" wheel brush
Filament Type:	.022"/320 grit crimped Nylox
Equipment Used:	Custom
Burr Class:	Class One

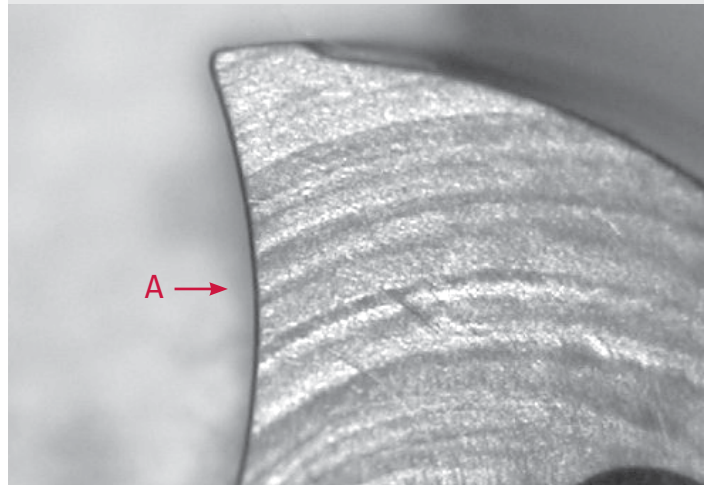

Cutting tool performance is very sensitive to the characteristics of the tool edge. For example, this carbide drill tip needs strong, defect-free edges (like A) to perform optimally.

Some parts must receive a small edge radius after the final grinding or machining operation. Nylox wheel brushes are extremely effective in this application. Cutting tools, turbine blades, clutch plates, and airframe components are just a few of the part types on which Nylox brushes can be used to accomplish this objective. Most commonly, edge radii requirements are between .001" - .010". However, larger radii can be produced in cases where longer cycle times are practical.

Precise, geometrically accurate edge radii are a unique result of abrasive nylon brushing operations. Many other deburring methods, including wire brushing, are not capable of producing precise edge radii. The carbide drill (pictured) was radiused using a Nylox wheel brush. The edge radius was .001" +/- .0002". Extremely accurate and consistent radii can be produced through precise control of application parameters.

PRODUCT GEOMETRIES

The first step in establishing an automated deburring process is to select the brush and parameters which can reliably achieve the specification in the required cycle time. This may not be possible when working with existing equipment. However, greenfield projects should always begin with this process. The following sections are intended to provide information on different brush types and the applications where they can be successfully employed.

WHEEL BRUSHES

The primary advantage of wheel brushes is that they can deliver a large number of filaments to a specific surface in a very short period of time. This makes them ideal for applications involving Class Three and Class Four burrs where the burrs are located on a well-defined edge. Gear deburring is a good example of a wheel brush application which is frequently automated. Although burrs can be large, they occupy a narrowly defined area which can be easily targeted with a wheel brush.

The gear deburring photo (right) shows a typical wheel brush operation. One important feature of all wheel brushes (regardless of size and fill material) is that they are uni-directional deburring tools; i.e., they will only remove burrs from one side of an edge. To deburr both sides of an edge, the part must be reoriented to allow the filaments to strike the opposite side. When refixturing is impractical, two brushes can be used as illustrated in the application at right.

Another important performance feature of wheel brushes is that they have no aggression to edges that are parallel to the brush. In order to be deburred with a wheel brush, the target edge must be perpendicular as much as possible to the brush face. Generally, the greater the deviation from this condition, the more limited the deburring action of the brush.



Wire wheel brushes are extremely effective for removing Class Three and Four burrs on gears and similar parts.

DIRECTIONAL SENSITIVITY OF WHEEL BRUSHES

The need for proper part orientation and brush direction is demonstrated by the following example.

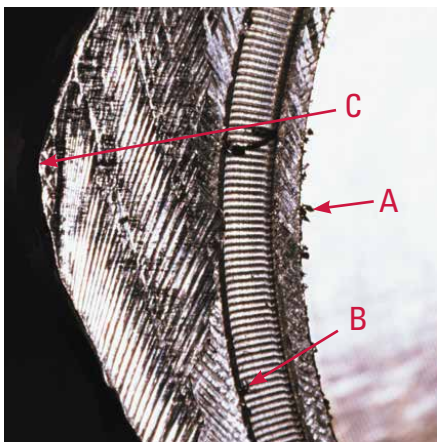

This pump housing is an example of a part with burred edges with different orientations. Edges A, B and C have burrs which must be removed.

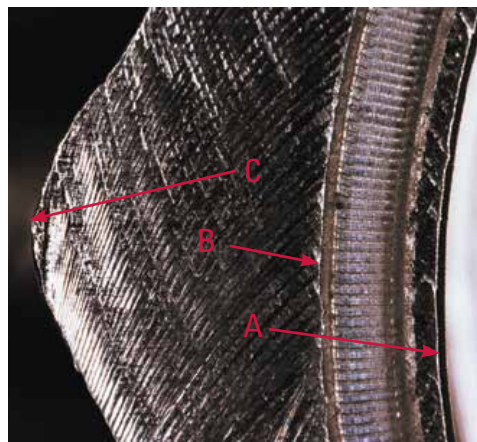

Edges A and B need to be deburred using right-to-left wire tip movement. The above picture shows edges A and B after deburring. Edge C can not be deburred using the same orientation.

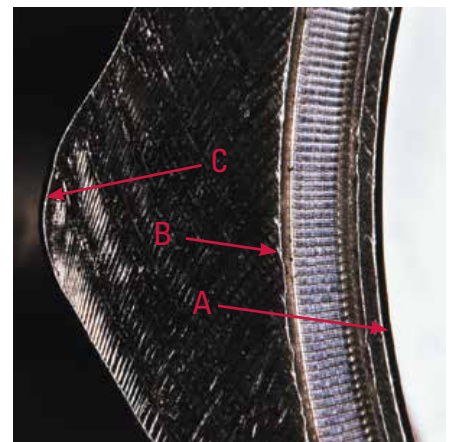

To deburr edge C, the part was moved to a different brush head on which the direction of brush rotation was reversed. This picture shows all of the edges after deburring.

DISC & CUP BRUSHES



While wheel brushes can be impractical for some applications due to the directional issues described on page 6, **disc and cup brushes are ideal for applications with multiple burred edges which lie in the same plane.** A good example is the blanked part at right. The burrs are distributed around the entire perimeter of the part. A disc or cup brush can be used to deburr this part in a single pass because the filaments attack all of the part edges uniformly. Disc and cup brushes are considered multi-directional deburring tools.

In addition to blanked parts, items which have been face milled are common candidates for this type of deburring. While burr size will vary according to the direction to cutter rotation, edges with various orientations can be deburred simultaneously.



Blanked steel part before deburring.



Blanked steel part after deburring.

END BRUSHES



Like disc brushes, end brushes are multi-directional deburring tools. **End brushes are used to deburr surfaces which cannot be reached with wheel and disc brushes.** Their small size makes them ideal for fitting into confined areas. It also makes them ideal for equipment with tool size limitations.

The machined hydraulic component pictured at right is an example of a part which needs a brush to deburr and uniformly finish an annular surface. The objective of the application was to deburr the part and reduce the surface finish to below 25 microinches Ra. This application can also be performed with a disc brush, but the size of the tool changer in the CNC equipment dictated the selection of an end brush.



Hydraulic component before deburring.



Hydraulic component after deburring.

TUBE BRUSHES



Crosshole deburring and bore cleaning are the most common applications for tube brushes. Their bottle-type shape makes them ideal for fitting into bores.

In most crosshole deburring applications, the brush must be plunged into the bore several times at a high feed rate. This ensures that all edges are deburred uniformly.

For bores larger than 1", Bore-Rx brushes (page 15) are recommended. The advantage of these products is their high filament density and reversibility. Due to construction features, tube brushes cannot be reversed.



Crosshole deburring of a small casting.

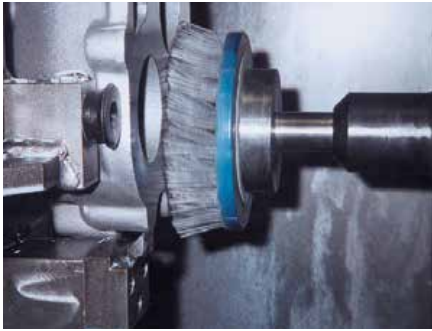

This cast aluminum exhaust manifold is an example of a part being deburred with a Nylox disc brush. To eliminate secondary deburring operations, the part is deburred and finished in the CNC machining center that performs the face milling.

IN-MACHINE DEBURRING refers to deburring parts in the same equipment where they are machined. In most cases, this type of solution is implemented by placing brushes in the tool changer of a CNC machining center. The primary advantages of this style of implementation are its negligible capital costs and its ability to combine two processes. The combining of processes can produce a wide variety of benefits including better part quality, reduced labor content, improved part flow, and increased untended production.

In-machine deburring is most successful on parts which require long machining cycles. Because these parts are normally difficult to handle and fixture, eliminating secondary deburring processes can be very advantageous.



Nylox brushes can be used to produce large edge radii on turbine blades. Robotic manipulation of the part provides a high degree of uniformity and good control of radius size. Using this type of process, edge radii of more than .020" can be produced.

ROBOTS ARE IDEAL TOOLS when complicated parts dictate that detailed motions are required for adequate deburring. Because robots can mimic the motions of a human hand, it is possible to manipulate the part or the tool in many ways to achieve optimal deburring efficiency.

Turbine blades are an excellent example of a part type suitable for robotic deburring. Due to the intricate part geometry and demanding radius requirements, turbine blades offer serious deburring challenges. By taking advantage of the flexibility of robotic systems, brush filaments can be applied to many different surfaces with different dwell times and produce a part which meets the demanding specifications required by this industry.



High throughput requirements make carbide inserts a good candidate for deburring with custom equipment.

CUSTOM DEBURRING EQUIPMENT is extremely common in applications requiring high throughput. Frequently, custom machines are designed to reach volumes in excess of 500 parts per hour. They can be automatically or manually loaded. Smaller custom machines can also be linked with upstream operations to produce consolidated processes in which deburring is performed in the same area as the primary metal-working process.

An example of parts requiring custom deburring equipment are carbide and ceramic cutting tools. They are produced in large quantities and need to be deburred after grinding or sintering - depending on tool type.

The availability of powerful CNC controllers enables custom equipment to offer high throughput and high flexibility. By preprogramming process variables into the controller, it is possible to achieve very rapid change-overs from one product variation to another.



*“Smart people learn from their own mistakes.
Brilliant people learn from the mistakes of others.”*

COMMON MISTAKES

The following are examples of the most common mistakes which are made during the development of new or improved brush deburring operations.

AVOID "THE PART IS SMALL SO THE BRUSH SHOULD BE SMALL" SYNDROME.

Although part geometry is a constant overriding consideration, most small parts do not need to be deburred with small brushes. When faced with a deburring operation involving a 1" part, engineers commonly choose a 6" brush to perform the deburring. While a 6" brush seems reasonable, a system with these characteristics will be a poor performer in 90% of cases. It will exhibit poor production stability, high consumable costs, and increased maintenance issues.

In contrast, a 10"-14" brush used on the same theoretical part offers many advantages. **Although the brush may seem oversized (and overly expensive on a price per brush basis), it will almost always reduce consumable costs per part, increase system stability, and reduce machine maintenance.** The improved operating results stem from a deburring system which is not stressed to the edge of its operating envelope. While a 6" brush might be able to remove the burr with considerable effort, a 14" brush would most likely deburr it easily with greater process stability.

A good rule of thumb is to use the largest, densest brush available. In Nylox brushes, a 14" OD with 1-3/4" trim length is an excellent starting point. In wire brushes, a 10" brush with high wire density is a good place to start.

DON'T GET CAUGHT IN THE SPEED TRAP.

Wire brushes and Nylox brushes work within certain surface speed ranges (see page 8). In many cases, these surface speeds do not correspond to spindle speeds of off-the-shelf motors. **As a result, direct-drive systems with standard motor speeds are often doomed from the design stage.** For example, a 14" Nylox wheel brush running at a standard motor speed of 1750 RPM will be essentially useless. At that speed, the part cannot be pushed into the brush face and no filing action can be accomplished. Similarly, a 10" wire brush running at 1750 RPM will be only marginally effective. The wire tips will have limited aggression and will be prone to roll the burr instead of removing it.

"ALMOST" IS NOT ENOUGH.

Hidden or masked burrs cannot be removed through mere proximity to a moving filament. While this may seem painfully trivial, inadequate burr access is a common problem with system design. **In order to be effective, filaments must have unimpeded, perpendicular access to the burred edge** (see page 6). Edges need to be oriented in a manner which minimizes any masking by other part surfaces and oriented to allow the filaments to strike the burr at a perpendicular angle.

In the case of wire brushes, the part should be oriented to allow the filaments to have maximum access to the root of the burr. This allows the maximum striking force to be delivered to the point at which the burr is joined to the part.

MORE POWER!

Without sufficient power, brush selection, parameter selection and equipment layout are irrelevant. For example, a 14" Nylox wheel brush with a 3" face which is engaged 3/4" into a rotating 2" part cannot be driven with a 1 hp motor. The motor will bog under the load and the process will yield poor results.

The power requirements listed on page 10 are valuable guidelines for brushes which are operated under common loads. However, the amount of engaged brush face and the depth of interference between the brush and the part are critical issues in determining motor size.

TUBE BRUSH SIZING

Wire tube brushes need to match hole I.D., oversizing the brush to create interference is not recommended.

Abrasive nylon tube brushes must be oversized to create a wiping action.

IMPLEMENTATION

The most important issue in establishing a deburring operation is defining the burr size which will need to be handled by the deburring process. Depending on the type of metal-working process, burr size can be affected by a wide variety of issues. It is critical to understand the upstream process variables which affect burr size and design a process which can handle the variation.

In addition to defining the burr size range, burr minimization is a key to economic deburring. Burr size can be significantly reduced by modifying and controlling key machining parameters. Once burrs have been defined and minimized and the ideal product geometry has been selected, deburring process variables need to be established. The following recommended process parameters are intended to be "starting points" from which further analysis should be performed. Due to the wide variety of deburring applications, one set of parameters is never ideal for all operations.

OPERATING PARAMETER GUIDELINES

WHEEL BRUSHES

Brush Size	Wire Brush Speed	Wire Brush DOI	Nylox Brush Speed	Nylox Brush DOI	*Power	Minimum Spindle Dia.
1"-2"	20,000	.030"	5,000	10% of trim	1/4 hp	1/4"
3"-4"	15,000	.030"	3,000	10% of trim	1/3 hp	3/8"
6"	5,000	.030"	1,750	10% of trim	1/2 hp	1/2"
8"	3,450	.030"	1,400	10% of trim	3/4 hp	5/8"
10"	2,500	.030"	1,200	10% of trim	1 hp	3/4"
12"	2,000	.030"	1,000	10% of trim	1-1/4 hp	1"
14"	1,750	.030"	800	10% of trim	1-1/2 hp	1-1/4"

*Note: Power recommendations are stated per one inch of engaged brush face.

END, DISC & CUP BRUSHES

Brush Size	Wire Brush Speed	Wire Brush DOI	Nylox Brush Speed	Nylox Brush DOI	*Power
1"	20,000	.030"	2,500	.100"	1/4 hp
2"	NA	NA	2,000	.100"	1/3 hp
3"	5,000	.030"	1,750	.100"	1/2 hp
4"	3,600	.030"	1,500	.100"	3/4 hp
6"	2,000	.030"	1,250	.100"	1 hp
8"	NA	NA	800	.100"	1-1/2 hp
10"	NA	NA	700	.100"	2 hp
12"	NA	NA	600	.100"	2-1/2 hp

*Power recommendations are based on brushes with 1/2" diameter tufts & 1-1/2" filament length operating at 0.100" DOI.

TUBE BRUSHES

Brush Diameter	Wire Brush Speed	Wire Brush DOI	Nylox Brush Speed	Nylox Brush DOI
1/8" - 1"	1,200 - 1,500	Match Hole I.D.	1,200 - 1,500	Hole I.D. + 10%

FEED RATES

Workpiece Material	BRUSH FILL MATERIAL		
	Wire	Aluminum Oxide or Silicon Carbide Nylox	Ceramic Nylox
Non-Ferrous	80 IPM	50 IPM	80 IPM
Cast Iron	60 IPM	30 IPM	60 IPM
Mild Steel & Ductile Iron	50 IPM	25 IPM	50 IPM
Alloy & Stainless Steel	30 IPM	15 IPM	30 IPM
Titanium & Hi-Nickel Alloy	30 IPM	15 IPM	30 IPM

COOLANTS

Wire brushes should not be run with coolants. Nylox brushes can be run dry or wet depending on the application. Nylox brushes can soften and melt under certain operating conditions. Coolants are an effective means of preventing this situation. However, some coolants lubricate the part surface and reduce the aggressiveness of the brushes. In these cases, dry operation helps minimize cycle time.

NOTE: Nylox brushes will not damage the ways in a CNC machine. Please see our Full Line catalog WC244 for more information.



DETERMINING OPERATIONAL PRIORITIES

What is the most important attribute of your deburring operation: Shortest cycle time? Minimum consumable cost per part? Greatest production stability? In a perfect world, it would be possible to have all of these things. In reality, there are tradeoffs between them. As a result, the design of the deburring process should be based on a clear ranking of priorities. The following graphs illustrate the tradeoffs between cycle time, consumable cost, and capability range (the range of burr sizes which can be removed by a specific brush and operating parameters).

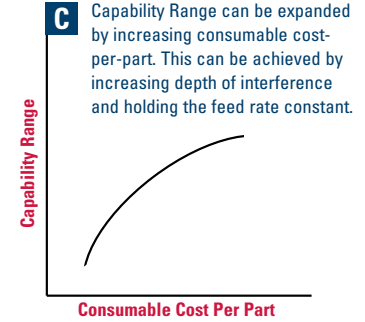
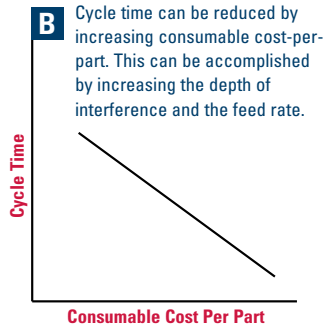
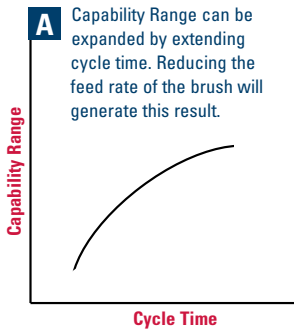

TOOL PATH

The ideal tool path for a Nylox disc brush is very similar to the path of the face mill that produced the burr. However, three differences exist:

- 1 The rotation direction of the brush should be opposite of the cutting tool that created the burr.
- 2 The length of the path must be longer than the part. Unlike a cutter path that can stop when the leading edge of the cutter reaches the end of the part, the tool path of a brush should continue until the trailing edge of the brush reaches the end of the part.

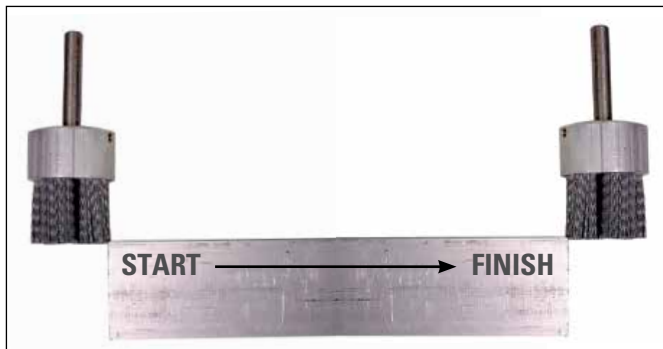

- 3 The centerline of the brush may need to be off-set from the center of the part in order to maximize the number of filaments that strike the part at a perpendicular angle. This is especially important when the diameter of the brush is similar to the width of the part.

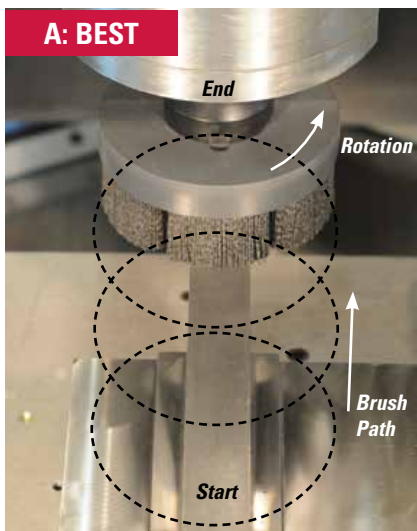

The part is deburred in the shortest cycle time with the lowest consumable cost-per-part. If a large diameter brush can be used, the centerline of the brush should be positioned on the center of the part. Ideally, the brush should be 3-4" wider than the part.

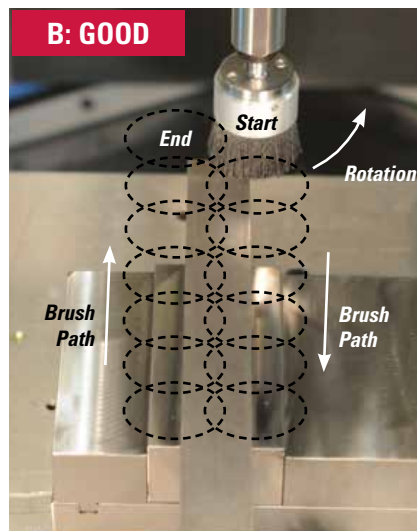

The part is deburred, but requires a longer cycle time. When a large brush will not fit in the tool changer, this method is recommended. If a small diameter brush must be used, the centerline of the brush should be positioned on the edge of the part. This maximizes aggression by increasing the amount of perpendicular contact between the brush filaments and the burred edge.

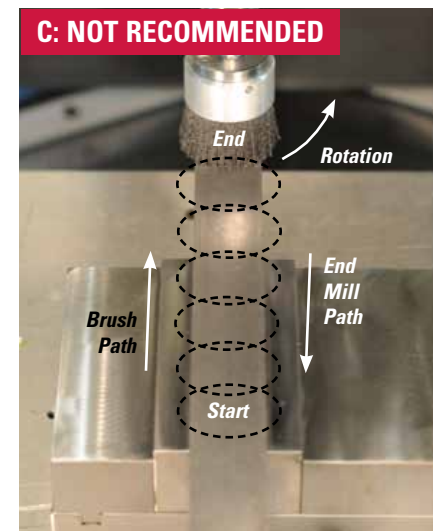

Produces less deburring than A & B. Positioning a small diameter brush with its centerline on the center of the part is not recommended. This configuration will not allow perpendicular contact of the filaments against the burred edge.

WIRE BRUSHES

STANDARD TWIST WHEELS provide heavy-duty brushing action with some flexibility; ideal for demanding cleaning applications on somewhat irregular surfaces.



08014



08085



08189

Dia.	Wire Size	Arbor Hole	No. of Knots	Face Width	Trim Length	Max. AH Avail.	Thickness at Face Plates	Max. RPM	Std. Pack	Item Number	
										Steel	Stainless
3"	.0118	1/2"-3/8"	20	3/8"	5/8"	1/2"	7/16"	25,000	10	08004	08254
	.014									08264	
	.020									08024 ▲	08274
4"	.0118	1/2"-3/8"	24	1/2"	7/8"	1/2"	7/16"	20,000	10	08034	08284
.014	08044									08294	
.020	08064									08314	
4"	.014	5/8"-1/2"	24	1/2"	7/8"	7/8"	7/16"	20,000	10	08045	—
6"	.0118	5/8"-1/2"	24	1/2"	1-3/8"	1-1/4"	9/16"	9,000	10	08075	08325
	.014									08085	—
	.016									08095	08345
	.023									08105	—
6"	.016	5/8"-1/2"	30	5/8"	1-1/4"	1-1/4"	5/8"	9,000	5	08975	—
7"	.014	5/8"	24	5/8"	1-7/8"	1-1/4"	9/16"	9,000	2	08835	—
8"	.0118	5/8"	38	5/8"	1-5/8"	2"	1/2"	6,000	2	08125	08375
	.014									08135	—
	.016									08145	08395
	.023									08155	—
8"	.014	3/4"	38	5/8"	1-5/8"	2"	1/2"	6,000	2	08138	—
10"	.014	3/4"	52	3/4"	1-3/4"	2-1/2"	3/4"	4,500	2	08178	—
10"	.014	1-1/4"★	52	3/4"	1-3/4"	2-1/2"	3/4"	4,500	2	08179	—
	.016	08189								—	
12"	.014	1-1/4"★	52	3/4"	2-3/4"	2-1/2"	11/16"	3,600	1	08209	—
	.016	08219								—	
12"	.014	2"◆	52	3/4"	2-3/4"	2-1/2"	11/16"	3,600	1	08200-14	—
12"	.020	1-1/4"★	56	5/8"	2-3/4"	3"	13/16"	4,500	2	09719	—
12"	.023	2"◆	66	3/4"	2-1/4"	3"	13/16"	5,000	2	09870	—
15"	.016	1-1/4"★	52	7/8"	4-1/4"	2-1/2"	3/4"	3,600	2	08249	—

★ 5/16" x 5/32" Double Keyway

◆ 1/2" x 1/4" Double Keyway

▲ Available in non-sparking bronze wire

BOLD BLACK ITEM numbers indicate color-coded brushes for easy identification.

STANDARD TWIST WHEELS - High Density & Extra High Density - Engineered for maximum performance in production applications; for use on automated equipment such as dedicated gear deburring machines.



08339



09020

Diameter	Wire Size	Arbor Hole	Face Width	Trim Length	Thickness at Face Plates	Max. RPM	Standard Pack	Item Number
80 KNOTS								
14"	.0118	1-1/4"★	3/4"	2-1/2"	5/8"	5,000	2	08309
	.0118	2"◆						08300
	.014	1-1/4"★						08319
	.014	2"◆						08310
	.020	1-1/4"★						08339
	.020	2"◆						08330
15"	.0118	1-1/4"★	3/4"	3"	5/8"	5,000	2	09969
	.0118	2"◆						09960
	.014	1-1/4"★						09989
	.014	2"◆						09980
	.020	1-1/4"★						09999
	.020	2"◆						09990
90 KNOTS								
14"	.014	2"◆	3/4"	1-1/2"	5/8"	5,000	2	09020*
	.016	2"◆						09790
	.016	1-1/4"★						09799
	.020	2"◆						09800
	.020	1-1/4"★						09809
	.020	1-1/4"★						09049*
15"	.020	2"◆	3/4"	2"	5/8"	5,000	2	09840
	.020	2"◆						09080*
	.020	1-1/4"★						09089*

★ 5/16" x 5/32" Double Keyway

◆ 1/2" x 1/4" Double Keyway

* Economy

CRIMPED WIRE END BRUSHES - Banded - Feature bands around the fill to reduce the exposed trim length and limit brush flaring at operating speed to provide an aggressive, controlled brushing action.

Diameter	Wire Size	Trim Length*	Overall Length	Max. RPM	Standard Pack	Item Number	
						Steel	Stainless
1/2"	.006	9/16"	2-9/16"	20,000	10	11100	11110
	.0104					11101	—
3/4"	.006	7/16"	2-11/16"	20,000	10	11102	11112
	.0104					11103	11113
1"	.006	3/8"	2-5/8"	13,000	10	—	11114
	.0104					11105	11115

* Trim length from bands



11112

CRIMPED WIRE WHEELS - High Density - Feature an increased fill density for greater brushing action, more consistent performance, and longer life in the most demanding applications requiring the flexibility of a crimped wire wheel.

Dia.	Wire Size	Arbor Hole	Face Width	Trim Length	Max. AH Avail.	Thickness at Face Plates	Max. RPM	Std. Pack	Item Number	
									Steel	Stainless
4-1/4"	.0118	5/8"-1/2"	3/4"	5/8"	3/4"	9/16"	6,000	1	01501	—
	.014								01502	—
6"	.008	5/8"-1/2"	3/4"	1-1/8"	1"	9/16"	6,000	1	01503	—
	.0118								01504	01508
	.014								01505	01509
	.020								01506	—
7"	.014	5/8"	7/8"	1-5/8"	1"	9/16"	6,000	1	01511	—
8"	.006	5/8"	7/8"	1-1/2"	1-1/4"	11/16"	4,500	1	01512	—
	.0104								01513	—
	.0118								01514	—
	.014								01515	—
10"	.0118	3/4"	1"	2-1/2"	1-1/4"	11/16"	4,500	2	01517	—
	.014								01518	—



01515

DOUBLE STEM, DOUBLE SPIRAL feature four stem wires and a double spiral of straight wire fill material to provide aggressive cleaning and deburring action.

Diameter	Wire Size	Brush Part	Stem Diameter	Overall Length	Max. RPM	Standard Pack	Item Number	
							Steel	Stainless
3/8"	.003	1-1/2"	1/8"	4"	2,000	10	21342	—
	.006	2-1/8"		6"			21232	—
1/2"	.004	2"	5/32"	5"	2,000	10	21106	21116
	.006						21107 ▲	21117
	.0104						21252	—
5/8"	.005	2"	7/32"	5"	2,000	10	21108	21118
	.008						21109 ▲	21119
	.0104						21184	—
3/4"	.006	2-1/2"	1/4"	5-1/2"	2,000	10	21110 ▲	21120
	.008						21247	—
	.0104						21111	21121
7/8"	.006	2-1/2"	1/4"	5-1/2"	2,000	10	21112	21122
	.0104						21113	21123
1"	.006	2-1/2"	1/4"	5-1/2"	2,000	10	21114 ▲	21124
	.0104						21115	21125
1-1/4"	.006	2-1/2"	1/4"	5-1/2"	2,000	10	21164	21245
	.0104						21167 ★	21236
1-1/2"	.014	2-1/2"	1/4"	5-1/2"	2,000	10	—	21413

▲ Available in non-sparking brass wire



21110



21342

BURR-RX CRIMPED FILAMENT WHEELS

Composite Metal Hub* - Crimped Round Black Ceramic Filament



86131



86135

Diameter	Filament Dia./Grit	Arbor Hole	Face Width	Trim Length	Thickness At Face Plates	Max. RPM	Standard Pack	Item Number
6"	.026/120	2"	3/4"	1"	15/16"	4,000	1	86123
	.035/80							86181
	.043/120							86124
	.055/80							86120
8"	.026/120	2"	7/8"	2"	15/16"	4,000	1	86126
	.043/120							86127
	.055/80							86128
10"	.026/120	2"★	1-1/8"	2"	7/8"	1,800	2	86129
	.035/80							86182
	.043/120							86130
	.055/80							86131
12"	.026/120	2"★	1-1/4"	3"	7/8"	1,800	2	86132
	.043/120							86133
	.055/80							86134
14"	.026/120	2"★	1"	1-3/4"	3/4"	1,800	2	86135
	.035/80							86108
	.043/120							86136
	.055/80							86137
14"	.026/120	2"★	1-1/4"	4"	7/8"	1,800	2	86138
	.043/120							86139
	.055/80							86140

*Patented

★ 1/2" x 1/4" Double Keyway

BURR-RX NARROW FACE WHEELS - Metal Hub - Crimped Round Black Ceramic Filament



31110

Diameter	Filament Dia./Grit	Arbor Hole	Face Width	Trim Length	Thickness Through Arbor	Max. RPM	Standard Pack	Item Number
3"	.026/120	5/8"-1/2"	9/16"	1/2"	7/16"	6,000	2	31240*
	.035/80							31241*
4"	.026/120	1/2"-3/8"	1/2"	7/8"	7/16"	6,000	2	86165
	.035/80							31103
	.043/120							31100
	.055/80							31105
4"	.026/120	5/8"-1/2"	5/8"	1"	7/16"	6,000	2	31110*
	.035/80							31270*
	.043/120							31280*
	.055/80							31290*

*Heavy-duty

BURR-RX® SMALL DIAMETER WHEELS - Metal Hub - Crimped Round Black Ceramic Filament



17568

Diameter	Filament Dia./Grit	Arbor Hole	Face Width	Trim Length	Max. RPM	Standard Pack	Item Number
1-1/4"	.026/120	1/4"	5/16"	5/16"	10,000	10	17551
1-1/2"	.026/120	1/2"	3/8"	1/4"	10,000	10	17541
2"	.026/120	1/2"	3/8"	1/2"	10,000	10	17548
	.035/80						17555
	.055/80						17542
2-1/2"	.026/120	5/8"	1/2"	11/16"	10,000	10	17556
	.035/80						17557
3"	.026/120	1/2"	1/2"	1"	10,000	10	17565
	.035/80						17567
	.043/120						17568

Other diameters and grit sizes available upon request.

DRIVE ARBORS for mounting small diameter wheels into a collet or chuck.



07723

07724

07729

Arbor Dia.	Stem Dia.	Stem Length	Length of Shaft	For Brushes with a Max. Dia. of	Overall Length	Max. RPM	Standard Pack	Item Number
Unthreaded Shaft								
1/4"	1/4"	1-1/8"	3/16"	2"	2-1/16"	20,000	5	07723
Threaded Shaft								
1/2"	1/4"	3/4"	3/4"	3"	1-3/4"	25,000	5	07724
5/8"	1/4"	3/4"	3/4"	3"	1-13/16"	25,000	5	07729

BORE-RX BRUSHES - 3/8" Stem - Crimped Round Black Ceramic Filament

Diameter	Filament Dia./Grit	Face Width	Trim Length	Overall Length	Max. RPM	Standard Pack	Item Number
7/8"	.026"/120	3/4"	.160"	4-3/4"	8,000	1	17206
1"	.026"/120	3/4"	.215"	4-3/4"	8,000	1	17208
1-1/4"	.026"/120	3/4"	.345"	4-3/4"	8,000	1	17210
1-1/2"	.026"/120	1"	.475"	5"	8,000	1	17212
2"	.026"/120	1"	.535"	3-1/4"	6,000	1	17215
2-1/2"	.055"/80	1"	.765"	3-1/4"	6,000	1	17217
3"	.026/120	1"		3-1/4"	6,000	1	86150
	.043/120						86151
	.055/80						86152
4"	.026/120	1"	1.040"	3-1/4"	6,000	1	86154
	.043/120						86155
	.055/80						86156

Note: All Bore-Rx brush stems have a 2" long flat for use in end mill holders. Alternatively, they can be mounted in 3/8" collets.



17208



86155

BURR-RX® TUBE BRUSHES - Crimped Black Ceramic Filament - 1/4" Cadmium Plated Stems

Diameter	Filament Dia./Grit	Length of Brush Part	Stem Diameter	Overall Length	Standard Pack	Item Number
3/8"	.026/120	1"	1/4"	3-1/2"	10	21758
1/2"	.026/120	1"	1/4"	3-1/2"	10	21759
5/8"	.026/120	1"	1/4"	3-1/2"	10	21761
3/4"	.026/120	1"	1/4"	3-1/2"	10	21762
7/8"	.026/120	1"	1/4"	3-1/2"	10	21763
1"	.026/120	1"	1/4"	3-1/2"	10	21764
1-1/4"	.026/120	1"	1/4"	3-1/2"	10	21765



21759

BURR-RX SHELL MILL HOLDER DISC BRUSHES - Crimped Black Ceramic Filament

Compatible with 3" shell mill holders.

Diameter	Filament Dia./Grit	Arbor Hole	Trim Length	Max. RPM	Standard Pack	Item Number
Round Filament						
4"	.026/120	1-1/4"	1-1/2"	2,500	1	86112
	.043/120					86113
	.043/120					86204*
	.055/80					86114*
6"	.026/120	1-1/4"	1-1/2"	2,500	1	86115
	.043/120					86116
	.055/80					86117*
8"	.026/120	1-1/4"	1-1/2"	2,500	1	86141
	.043/120					86142
	.055/80					86143*
10"	.026/120	1-1/4"	1-1/2"	2,500	1	86125
	.043/120					86121
	.055/80					86122*
Rectangular Filament						
4"	80	1-1/4"	1-1/2"	2,500	1	86167*
6"	80	1-1/4"	1-1/2"	2,500	1	86198*
8"	80	1-1/4"	1-1/2"	2,500	1	86199*



86112



86143

* Maximum Density

BURR-RX® MINI DISC BRUSHES - Maximum Density - Crimped Black Ceramic Filament

Diameter	Filament Dia./Grit	Arbor Hole	Drive Arbor + Recommendation	Trim Length	Max. RPM	Standard Pack	Item Number
Round Filament							
2"	.026/120	3/8"	89029 or 89033	1-1/4"	4,500	1	86106
	.035/80						85738
	.043/120						86107
	.055/80						85733
3"	.026/120	3/8"	89029 or 89033	1-1/4"	4,500	1	86109
	.035/80						86013
	.043/120						86110
	.055/80						86111
Rectangular Filament							
2"	80	3/8"	89029 or 89033	1-1/4"	4,500	1	85736
3"	80	3/8"	89029 or 89033	1-1/4"	4,500	1	86014



85733

MINIATURE & BURR-RX™ DISC BRUSH DRIVE ARBORS - Includes drive arbor, set screw and hex key. Recommended for operations in which brush rotation alternates between forward and reverse.

For Brush Diameter	Stem Diameter	Stem Length	Max. RPM	Standard Pack	Item Number
2"-3"	1/2"	1-3/4"	6,000	1	89033*



89033

*For use with Burr-Rx Mini Disc brushes only. Products supplied with set screw and wrench.

ASK THE EXPERT



WPS

Increasing Competitive Capability Through Process Improvements

Weiler Process Solutions (WPS) is a structured application engineering program designed to provide Weiler customers with engineering support to identify value added cost savings opportunities in their respective processes.

WPS is a comprehensive process where our expert application engineers access a specific process in order to identify improvement opportunities resulting in quantifiable cost savings.

WPS Benefits Include:

- Reduced cycle times
- Elimination of bottlenecks
- Reduced consumable and tooling cost
- Elimination of rejections and rework
- Reduce energy consumption
- Reduced work in process
- Documented cost saving
- Documented best practices
- Elimination of process variability

For more information and to schedule a consultation with a WPS expert visit:
www.weilerabrasives.com/wps

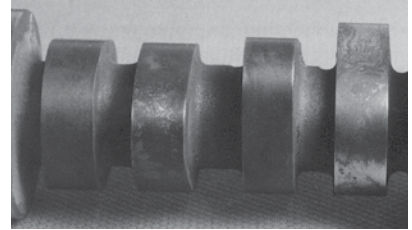

PROBLEM

The goal was to deburr the edges of the camshaft's lobes, remove heat scale and create a specified surface finish. It's a problem that required an innovative, time-saving and cost-effective solution.

EVALUATION

The Weiler Application Engineering Team starts with a thorough on-site evaluation of the problem. This free consultation includes questions of production volume, process cycle time, existing process limitations and the rationale for changing the existing process. Sometimes recommendations to modify an existing process or assistance in developing new machinery can be provided at the site. Other times, further evaluation is required at our in-house lab.

ANALYSIS

We take a very close look at the problem. For example: How heavy are the burrs or heat scale? Is an edge radius required? What was the original surface finish? How much variation exists in incoming part condition? Next, we investigate possible alternatives, such as the type of brush or abrasive product capable of doing the job and what tools are necessary. Issues such as RPM, speeds, feeds and other process parameters are reviewed and analyzed.

TEST

Laboratory testing is where solutions are developed, tried and refined. By using our controlled environment, we are able to develop solutions without interrupting the end users' production schedules. This testing phase typically reveals a number of viable alternatives. Here we explore issues such as cycle time, finish, product life and other essential criteria. Most times, a solution is developed based on the standard line of Weiler products. Other times, a custom-designed product is necessary to solve a specific application.

VERIFICATION

This is a scientific examination of the test. Did the recommended solution produce the required results? For example: Are the lobe and journal edges completely burr-free and radiused? Has the heat scale been completely removed? Does the surface finish meet the end users' specifications?

SOLUTION

Solving our end users' problems is more than achieving the desired finish. It's also about the process and the time and labor savings that bring enhanced value. Our goal is to develop a recommended solution within 48 hours after receiving information on the problem. We know that time is an essential ingredient to creating enhanced value. The Weiler approach to Application Engineering Solutions is to smooth out all the rough spots in the product as well as the process.

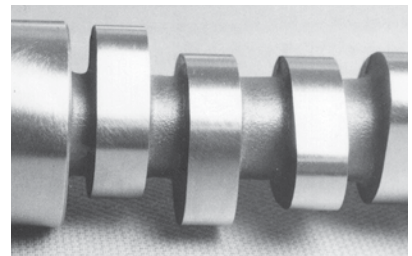

WEILER

