



SAWING PRODUCTS

Band Saw Blades



There's Nothing We Can't Cut

The DoALL® brand has always been known for band sawing. DoALL invented the first metal cutting band saw and has continued to be a leader in band sawing innovations. We are the only manufacturer to offer all the sawing elements, including sawing machines, blades, cutting fluids and material handling.

Our products are a cut above the rest!

With our years of experience we are true metalworking experts. Our DoALL technical support team and customer service team will work with you to find the right solution for your sawing application.



Solutions for ALL Your Sawing Needs

Contents

DoALL® SAW BLADES

DoALL Guarantee	2
Selecting & Ordering the Right Blade	3

BI-METAL SAW BLADES

Silencer® GP - 303	4
Silencer Plus - 306, 333, 336	4
StructurALL® - 320, 340	5
StructurALL Prime - 338	5
Penetrator® - 301	6
Penetrator Prime - 307	6
TiN Coated Penetrator - 319	6
Supreme™ - 381	7
TiN Coated Supreme - 319	7

TUNGSTEN CARBIDE BLADES

T3P "Triple Chip" - 326, 328	8
T3N "Triple Chip" - 331	8
T3W "Triple Chip" Wave - 327	8
T7P - 332	9
STC "TC Set" - 305	9
STW - 375	9

CARBON STEEL BLADES

Dart® - 308, 309	10
Metal Master™ - 334, 335	10
Friction - 310	11
Olympia™ - 358	11

KNIFE EDGE BLADES

Straight - 313	12
Honeycomb - 314	12
V-Tooth - 315	13
Wavy - 315	13
Scallop - 314	14

GRIT & CIRCULAR BLADES

Superabrasive Grinding Products	14
Grit Edge Tungsten Carbide - 325	15
Grit Edge Diamond - 406	15
Circular	16
Circular Blades Selectors	17

BLADE TECHNOLOGY

Blade Geometry and Characteristics	18
Chip Characteristics & Blade Break-In	19
DoALL Band Saw Blade Selector	20
Band Speed & Group Selector	21
Pitch Selector Solid Material	22
Pitch Selector Structural Material	23



THE DOALL GUARANTEE

Guaranteed Performance

Our experienced sawing specialists will review your requirements and make a specific recommendation on the best saw blade to meet your needs. If the DoALL blade we recommend doesn't outperform the blade you're currently using, we'll refund your money!

Guaranteed Quality

Every DoALL blade is unconditionally guaranteed to be completely free of defects in material and workmanship. Every weld is guaranteed for proper tooth spacing, matched set, exact finishing, controlled annealing to match temper of backing, and overall alignment within 0.001 inch.

Guaranteed Delivery

DoALL Sawing Products distributors are located in most metropolitan areas in North America and throughout the world. They inventory blades and provide local sales and service. Regional Blade Welding Centers maintain larger inventories for guaranteed delivery.

Guaranteed Satisfaction

Guaranteed performance, quality and delivery are important, but guaranteed customer satisfaction is our goal. We "go beyond the sale" to make sure you're satisfied. We can adjust your machines, train your operators, and provide many other services. We're not satisfied until you are.



Selecting & Ordering the Right Blade

Step 1. Choose a DoALL Blade Style

Use the Band Saw Blade Selector chart (on page 20) to select a blade style for the material(s) you are cutting. For example, if you were cutting non-ferrous aluminum in high production you would use a Tungsten Carbide – T3P blade (chart inset with example shown at right).

Step 2. Determine a Blade Pitch in Teeth/Inch (TPI)

Use either the Solid Material or Structural Material Pitch Selector charts (on page 22-23) to determine the correct blade pitch, a measure of tooth spacing in teeth per inch, for the size of your material(s). The number of teeth over a one-inch length is the TPI. The pitch designation of a multipitch blade hyphenates the equivalent single pitch designations of those extremes. For example, if you were cutting a 4" diameter solid round piece of non-ferrous aluminum with a Tungsten Carbide – T3P blade you would select a pitch of 3-4 TPI (chart inset with example shown at right).

Step 3. Determine Your Band Saw Blade Width, from Tooth Tip to Back Edge

Most sawing machines accept only one blade width, which is typically specified in the instruction manual (sample manual section shown to the right). For contour sawing, choose the widest blade that can cut the smallest work radius.

Step 4. Order the Catalog Number Corresponding to Style, Pitch and Width

For example, if you were cutting a 4" diameter solid round piece of non-ferrous aluminum with a Tungsten Carbide – T3P blade you would select a pitch of 3-4 TPI. If the instruction manual recommended using a 1-1/2" wide, 271 inch long blade for optimum cutting you would use the blade chart to choose the 328-434 catalog number. By adding 271 to the end of the catalog number you specify the length of the blade, in this case 328-434271.000.

Step 5. Ordering the Right Blade Length

Blade part numbers are a combination of the catalog number and three numbers that indicate the blade length, as explained below. To order welded bands, attach the band length in inches to the end of the catalog number. For example, if you want a 180 inch welded band of catalog number 302-961, order part 302-961180.000. For bands 99 inches or shorter, lead with a zero. To order a 93 inch welded band of catalog number 302-961, order part 302-961093.000. To order a coil of blade, attach the ordering code from the table below to the end of the catalog number. Check the blade style page for available coil lengths. For example, to order a 100 foot coil of catalog number 308-288, order part number 308-288001.000.

Coil Length:	100 ft (30mm)	150 ft (46m)	250 ft (76 m)	300 ft (91m)	500 ft (152m)	Random
Ordering Code:	001	015	025	003	005	012

BLADE TYPE	NON-METALS	NON-FERROUS	EASY
	Wood Plastic Rubber	Aluminium Copper Brass Free machining steels	Mild steels Low carbon Alloy steels
BI-METAL		For highest productivity and	
Silencer GP	Longer wear life		General purpose Bi-M
Silencer Plus		Best all round choice for multi-purpose applica	
StructurALL		Best choice for structurals, tubing and bundles	
StructurALL Prime		StructurALL with improved heat and wear resi	
Penetrator		Best choice for most high production sawing a	
Penetrator Prime		Penetrator with improved heat and wear resi	
TiN Penetrator		Penetrator with improved wear resistance	
Supreme			
TiN Supreme			
TUNGSTEN CARBIDE		For the toughest and most abrasive applicatio	
T3P		High production rate	
T7P			

Step 1. Use the Band Saw Blade Selector chart.

		Workpiece Size In Diameter																		
		1/8	3/4	3/8	1/2	1	2	2.5	3	4	5	6	8	10	12	14	16	20	24	28
		3	6	10	15	30	45	60	80	100	120	150	200	250	300	350	400	500	600	700
TPI	30-34																			
	8-12																			
	6-10																			
	5-8																			
	4-6																			
	3-4																			
	2-3																			
	1.5-2																			
	1-1.5																			
	0.7-1																			

Step 2. Use Pitch Selector for your material and blade style.

SAW BAND PREPARATION

Recommended Saw Band

- The machine is shipped with a saw band installed. The saw band recommended for use with this machine is 271 inches (6883.4 mm) long, 1-1/2 inch (38.1 mm), and has a .050 (1.27 mm) gage thickness.

Step 3. Determine band width and length from the instruction manual.

DoALL Blade Order Number General Standard

333-346184.000

333-	346	184	.000
Blade Catalog Number	Blade Pitch Catalog Number	Blade Length in Inches	¼ Inch Increments

Step 5. This chart explains numbering used to order the right blade length. There may be some exceptions.

Bi-Metal - Silencer® GP

Catalog # 303

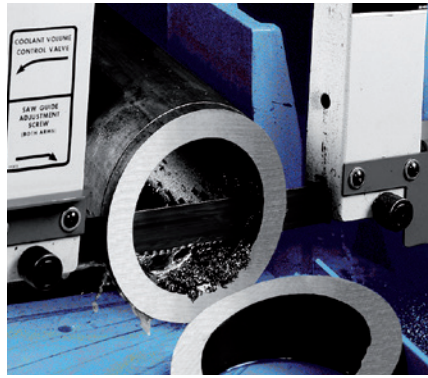
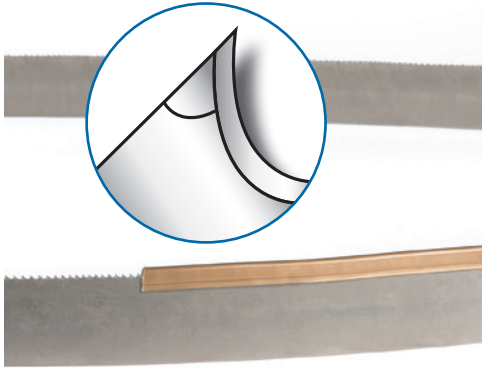

For general purpose sawing of most metals.

Features:

- M42 HSS tooth
- Neutral rake angle
- Excellent replacement for legacy DoALL Matrix® brand blades (Catalog #302)

Benefits:

- Wide range of sizes and pitches
- Strong, wear resistant tooth stays sharp longer

Applications:

- All metals in tubing, profiles and small solids
- Best choice for manual/semi-automatic machines and short blade lengths

Inch (mm)		Silencer GP Blade-Pitch Catalog Number										
Width	Gauge	2	3-4	4-6	5-8	6	6-10	10	8-12	14	10-14	18
1/4" (6)	0.035" (0.9)										303-010	
3/8" (10)	0.035" (0.9)					303-011		303-033		303-034	303-014	
1/2" (13)	0.025" (0.6)		303-035			303-015	303-933		303-935	303-019	303-133	303-026
	0.035" (0.9)				303-932	303-020	303-934		303-936		303-028	
3/4" (20)	0.035" (0.9)			303-410	303-182		303-415		303-300		303-420	303-430
1" (27)	0.030" (0.7)	303-999*		303-471*	303-475*							
	0.035" (0.9)		303-903	303-900	303-905	303-743	303-901		303-400		303-769	
1-1/4" (34)	0.042" (1.1)		303-904	303-902	303-539	303-770	303-562		303-600			
1-1/2" (41)	0.050" (1.3)			303-687	303-729		303-610					

* Wide set precision teeth provide greater back clearance

Bi-Metal - Silencer Plus

Catalog # 306, 333, 336

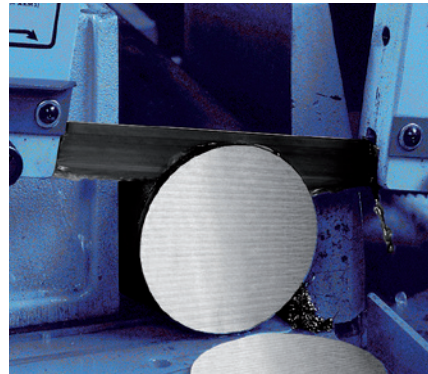
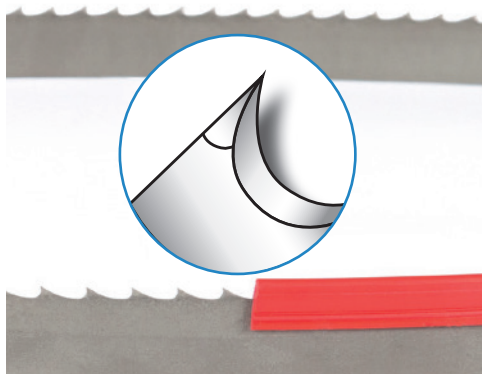

For sawing a wide variety of shapes and materials.

Features:

- M42 HSS tooth
- Positive rake angle

Benefits:

- Aggressive, wear resistant, multi-purpose blade
- Available in several wide pitches to limit pinching
- Longer life at higher cutting rates
- Extensive tests have shown improved performance, reduced noise level and improved reliability

Applications:

- All metals especially used in solids
- Not for interrupted cutting

Inch (mm)		Silencer Plus Blade-Pitch Catalog Number									
Width	Gauge	1-1.3	1.5-2	2	2-3	3	3-4	4	4-6	5-8	6
1/4" (6)	0.035" (0.9)										333-046
3/8" (10)	0.035" (0.9)							306-487			
1/2" (13)	0.035" (0.9)					333-023		306-488			333-026
3/4" (20)	0.035" (0.9)					333-103			333-146	333-158	
1" (27)	0.035" (0.9)				333-223		333-234		333-246	333-258	
1-1/4" (34)	0.042" (1.1)				333-323		333-334		333-346	333-358	
1-1/2" (41)	0.042" (1.1)	336-413									
	0.050" (1.3)				333-423		333-434		333-446	333-458	
2" (54)	0.050" (1.3)		306-445		336-523		336-534		336-546	336-558	
	0.063" (1.6)		306-512		333-523		333-534		333-546	333-558	
2-5/8" (67)	0.063" (1.6)	306-611	306-612		306-640						
3-1/8" (80)	0.063" (1.6)	306-711									

* Wide set precision teeth provide greater back clearance

Bi-Metal - StructurALL®

Catalog # 320, 340

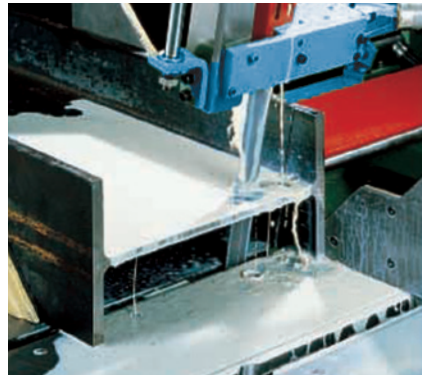
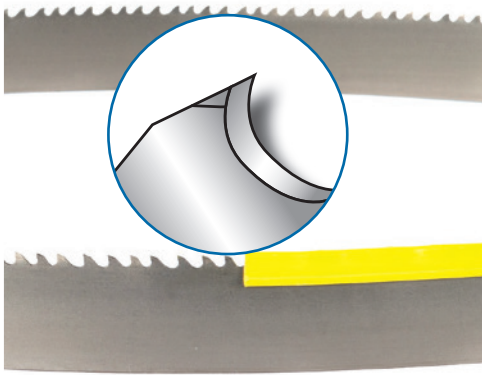

For optimal performance on structural material and bundles.

Features:

- M42 HSS tooth
- Positive rake angle

Benefits:

- Controlled, quiet sawing on non-solid materials
- Strengthened teeth, superior blade life
- Teeth resist stripping in structural materials and bundles

Applications:

- Specially designed for tubing and structural material, including single or bundle applications
- First choice for fabricators
- Best choice for less than rigid set-ups

Inch (mm)		StructurALL Blade-Pitch Catalog Number			
Width	Gauge	2-3	3-4	4-6	5-8
1" (27)	0.035" (0.9)		320-234	320-246	320-258
1-1/4" (34)	0.042" (1.1)		320-334	320-346	320-358
1-1/2" (41)	0.050" (1.3)	320-423	320-434	320-446	320-458
			320-435		320-457
2" (54)	0.050" (1.3)	340-523	340-534	340-546	
	0.063" (1.6)		320-534	320-546	
2-5/8" (67)	0.063" (1.6)		320-535**		
		320-623	320-634	320-646	
			320-635*		

* Extra wide set

** Narrow set

Bi-Metal - StructurALL Prime

Catalog # 338

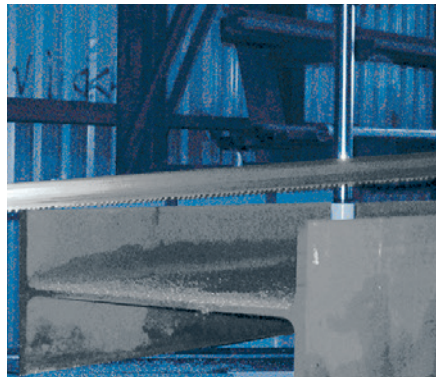
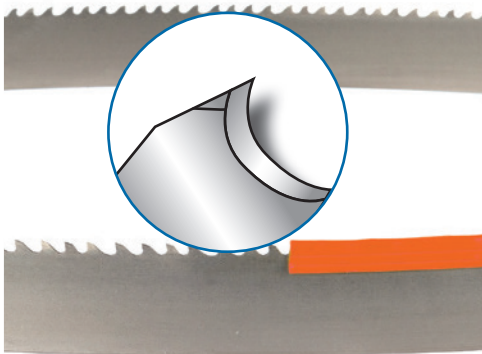

Features:

- M81 powder metal tooth tip
- Positive rake angle
- Special ground tooth form
- Extreme shock proof design

Benefits:

- Controlled, quiet sawing on non-solid materials
- Strengthened teeth, superior blade life
- Teeth resist stripping in structural material and bundles

Applications:

- Tubing and structural material both single and bundle or nest
- Good for small diameter solids

Inch (mm)		StructurALL Prime Blade-Pitch Catalog Number			
Width	Gauge	2-3	3-4	4-6	5-8
1 1/4" (34)	0.042" (1.1)		338-334	338-346	338-358
1 1/2" (41)	0.050" (1.3)	338-423	338-434	338-446	338-458
2" (54)	0.063" (1.6)	338-523	338-534	338-546	
			338-535**		
2 5/8" (67)	0.063" (1.6)	338-623	338-634	338-646	
		338-625*			

* Extra wide set

** Narrow set

Bi-Metal - Penetrator®

Catalog # 301

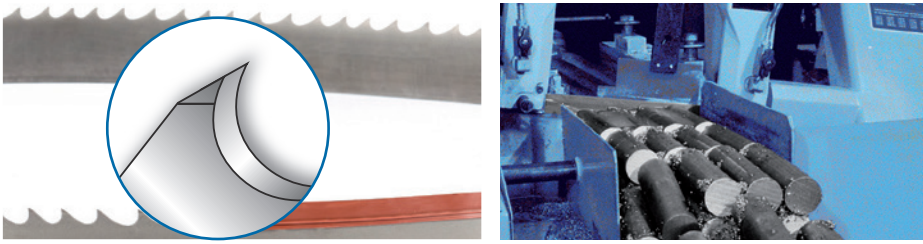

For fast production cutting of most solids.

Features:

- M42 HSS tooth
- High positive rake angle, curvilinear tooth form

Benefits:

- Fast cutting, wear resistant blade
- Ideal for high production sawing
- Aggressive tooth tip makes cutting up to 20% faster at same feed force setting!

Applications:

- Moderate to difficult alloys on power saws
- First choice for stainless steel

Inch (mm)		Penetrator Blade-Pitch Catalog Number									
Width	Gauge	0.8-1.2	1-1.5	1.3	1.5-2	2	2-3	3	3-4	4-6	5-8
3/4" (20)	0.035" (0.9)									301-041	
1" (27)	0.035" (0.9)						301-423	301-719	301-598	301-615	301-656
1 1/4" (34)	0.042" (1.1)			301-594		301-842	301-689		301-739	301-748	301-789
1 1/2" (41)	0.050" (1.3)		301-330		301-880		301-879		301-887	301-375	
2" (54)	0.050" (1.3)						301-381				
	0.063" (1.6)		301-071		301-070		301-069		301-085	301-384	
2 5/8" (67)	0.063" (1.6)	301-183	301-185		301-186		301-184		301-187		
3 1/8" (80)	0.063" (1.6)	301-430							301-990		

Bi-Metal - Penetrator Prime

Catalog # 307



Features:

- M81 powder metal tooth tip
- High positive rake angle, curvilinear tooth form
- Previously referred to as PMP blades

Benefits:

- Most wear-resistant Bi-Metal tooth
- High production rates with extended blade life

Applications:

- Ideal for high production sawing
- Moderate to difficult alloys on power saws

Inch (mm)		1.5-2	2-3	3-4	4-6	5-8
1" (27)	0.035" (0.9)			307-660	307-665	307-670
1 1/4" (34)	0.042" (1.1)		307-689	307-739	307-759	307-760
1 1/2" (41)	0.050" (1.3)	307-877	307-879	307-887	307-893	
2" (54)	0.063" (1.6)	307-901	307-902	307-903	307-546	
2 5/8" (67)	0.063" (1.6)		307-912			
3 1/8" (80)	0.063" (1.6)			Special order		

Bi-Metal - TiN Coated Penetrator

Catalog # 319

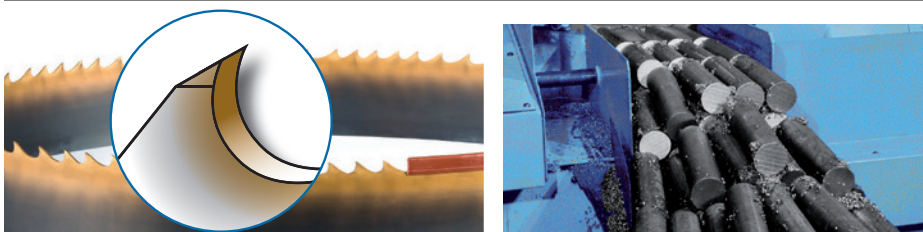

Features:

- M42 HSS tooth
- Low surface friction

Benefits:

- Improved wear resistance
- Extended life over standard Penetrator blade

Applications:

- Use these blades to saw any material recommended for Penetrator blades
- For large volume cutting jobs

Inch (mm)		TiN Coated Penetrator Blade-Pitch Catalog Number					
Width	Gauge	1-1.5	1.5-2	2-3	3-4	4-6	5-8
1/2" (13)	0.025" (0.6)				319-030		
1" (27)	0.035" (0.9)			319-423	319-598	319-615	319-645
	0.042" (1.1)			319-523			
1 1/4" (34)	0.042" (1.1)			319-558	319-533	319-567	319-789
1 1/2" (41)	0.050" (1.3)		319-880	319-640	319-319	319-375	
2" (54)	0.063" (1.6)			319-327	319-085		
			319-512WS		319-534		
2 5/8" (67)	0.063" (1.6)	319-185		319-184	319-612WS		
3 1/8" (80)	0.063" (1.6)			319-623	319-632		
					Special order		

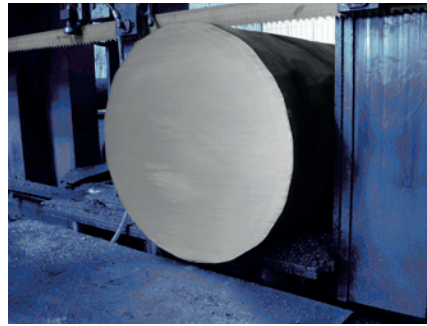
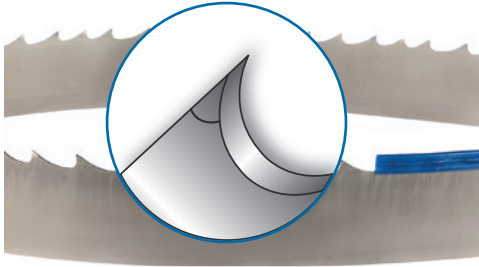

For aggressive penetration in very tough solids.

Features:

- M81 powder metal tooth tip
- Extreme high positive rake angle

Benefits:

- Long tool life on difficult to cut materials
- Improved penetration
- Higher cutting rates

Applications:

- For difficult to cut materials like nickel based alloys and other exotics

Inch (mm)		Supreme Blade-Pitch Catalog Number						
Width	Gauge	0.8-1.2	1-1.3	1.5-2	2-3	3-4	4-6	5-8
1" (27)	0.035" (0.9)					381-234	381-246	381-258
1 1/4" (34)	0.042" (1.1)				381-323	381-334	381-346	381-358
1 1/2" (41)	0.050" (1.3)			381-412	381-423	381-434	381-446	
2" (54)	0.063" (1.6)		381-511	381-512	381-523			
				381-512WS*				
2 5/8" (67)	0.063" (1.6)	381-681	381-611	381-612				
				381-612WS*				
3 1/8" (80)	0.063" (1.6)	381-781	381-711					

* Wide Set

Powdered Metal Tooth Tips

Powdered metal tooth tips above have a fine carbide size (light color) and uniform distribution. Up to 25% more carbide forming elements provide 70 Rc tip hardness.

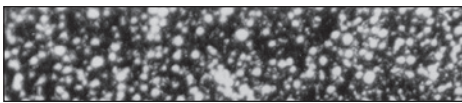

(1,000 X micro photograph)

Conventional high speed steel teeth above have uneven carbide sizes and distribution.

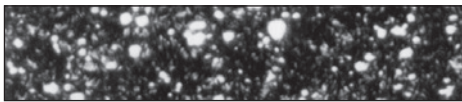

(1,000 X micro photograph)

Blade Life

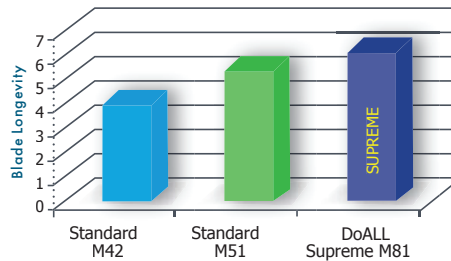

Extensive Tests Have Shown

- Significantly longer blade life
- Improved surface finish
- Low noise level
- Excellent chip breaking

These blades were tested with DoALL cutting fluid under normal working conditions with the following parameters:

- Material H13
- Cutting rate 5.2 in²/min
- Band speed 92 ft/min

Surface Finish

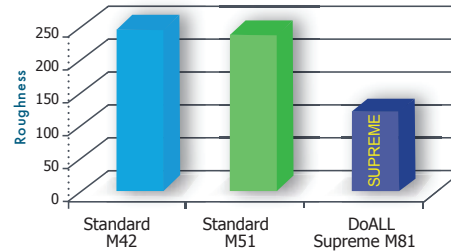

Bi-Metal - TiN Coated Supreme

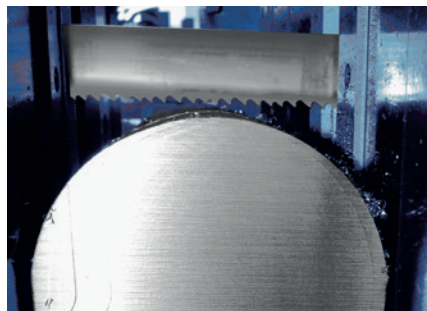
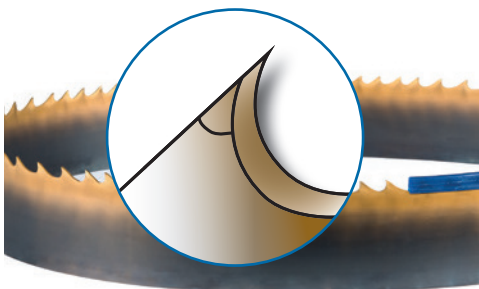

For extending the life of selected bi-metal blades.

Features:

- Low surface friction
- M81 Powder metal tooth tip
- Extreme high positive rake angle

Benefits:

- Improved wear resistance
- Extended blade life over standard Supreme

Applications:

- Use these blades on any material recommended for Supreme blades
- For large volume cutting jobs

Inch (mm)		TiN Coated Supreme Blade-Pitch Catalog Number		
Width	Gauge	2-3	3-4	4-6
1" (27)	0.035" (0.9)		319-634	319-635
1 1/4" (34)	0.042" (1.1)	319-656	319-658	
1 1/2" (41)	0.050" (1.3)	319-809	319-814	

Tungsten Carbide - T3P

Catalog # 326, 328

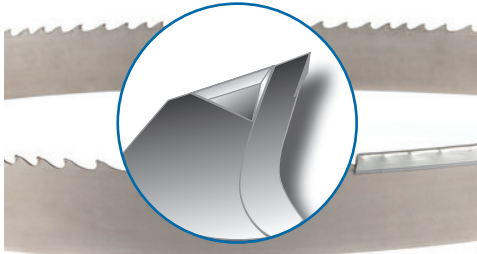

Triple chip positive rake.

Features:

- Tungsten carbide tooth
- Positive rake angle

Benefits:

- Heat resistant blade
- Aggressive sawing with a smooth finish

Applications:

- Super alloys and high nickel alloys such as titanium
- Ideal for production sawing

Inch (mm)		T3P Blade-Pitch Catalog Number					
Width	Gauge	0.7-1	1-1.3	1.3-2	2-3	3	3-4
3/4" (20)	0.035" (0.9)					326-025	
1" (27)	0.035" (0.9)				328-223	326-035	328-234
1 1/4" (34)	0.042" (1.1)			328-331	328-323	326-045	328-334
1 1/2" (41)	0.050" (1.3)			328-431	328-422	326-074	328-434
2" (54)	0.063" (1.6)	328-571	328-511	328-532	328-523		
2 5/8" (67)	0.063" (1.6)		328-611	328-672	328-623		
3 1/8" (80)	0.063" (1.6)	328-771	328-711				
		328-773*					

* Wider kerf

Tungsten Carbide - T3N

Catalog # 331

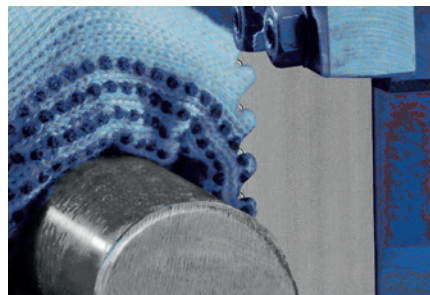
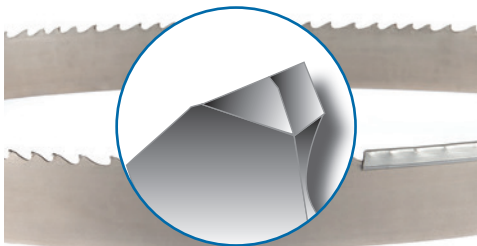

Triple chip negative rake.

Features:

- Tungsten carbide tooth
- Negative rake angle

Benefits:

- Heat resistant blade
- Sawing with a smooth finish

Applications:

- For case hardened materials

Inch (mm)		T3N Blade-Pitch Catalog Number
Width	Gauge	3-4
1" (27)	0.035" (0.9)	331-234
1 1/4" (34)	0.042" (1.1)	331-334
1 1/2" (41)	0.050" (1.3)	331-434

Tungsten Carbide - T3W

Catalog # 327

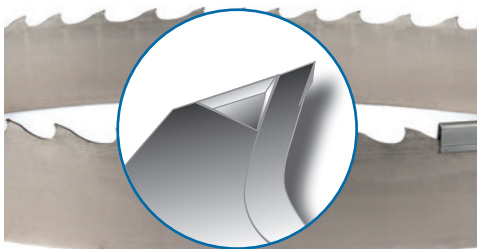

Triple chip wavy tooth.

Features:

- Tungsten carbide tooth
- Triple chip tooth design
- Positive rake tooth
- Wave tooth height variation

Benefits:

- All the advantages of production tungsten carbide blade with enhanced penetration for the toughest metals

Applications:

- Large size super-alloys
- Titanium

Inch (mm)		T3W Blade-Pitch Catalog Number		
Width	Gauge	1.3 - 2	2 - 3	3 - 4
1 1/4" (34)	0.042" (1.1)			327-334
1 1/2" (41)	0.050" (1.3)		327-422	
2" (54)	0.063" (1.6)	327-532	327-523	

Tungsten Carbide - T7P

Catalog # 332

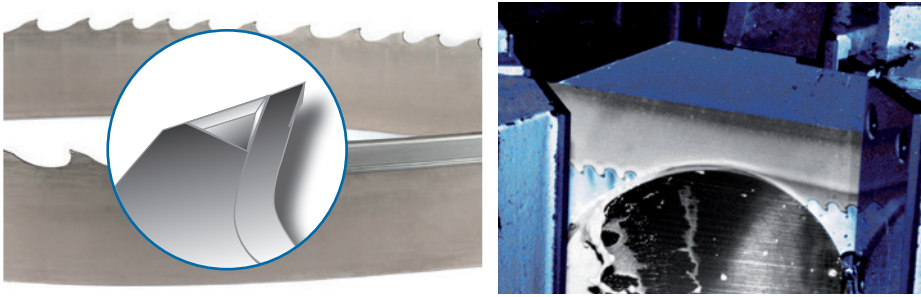

Features:

- Tungsten carbide tooth
- Positive rake tooth
- Seven grind pattern

Benefits:

- Heat resistant blade
- Aggressive sawing with a smooth finish
- Enhanced penetration in the toughest metals

Applications:

- Large diameter super alloys, high nickel alloys, titanium, etc.

* Call for special lengths

Inch (mm)		T7P Blade-Pitch Catalog Number					
Width	Gauge	0.7-1	1-1.3	1.3-2	2	2-3	3-4
1" (27)	0.035" (0.9)						332-234
1 1/4" (34)	0.042" (1.1)				332-302	332-323	332-334
1 1/2" (41)	0.050" (1.3)			332-432		332-423	332-434
2" (54)	0.063" (1.6)	332-571	332-511	332-532		332-523	332-534
2 5/8" (67)	0.063" (1.6)	332-671	332-611	332-632		332-623	
3 1/8" (80)	0.063" (1.6)	332-771	332-711				

Tungsten Carbide - STC

Catalog # 305

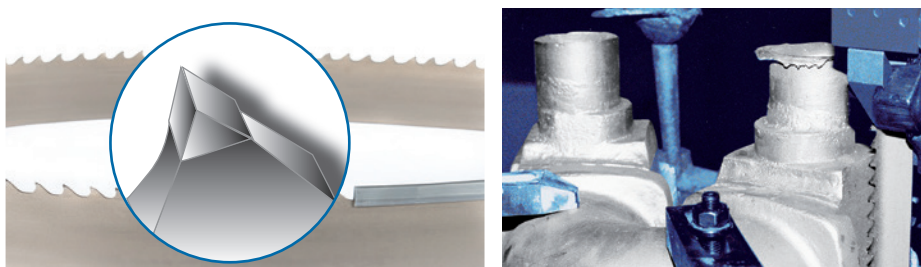

Set tooth tungsten carbide for cutting highly abrasive materials.

Features:

- Tungsten carbide tooth
- Positive rake angle
- Also known as "TC Set" blades

Benefits:

- Withstands rapid tool wear caused by fast cutting of highly abrasive materials

Applications:

- Abrasive materials that dull carbon and bi-metal blades rapidly, such as aluminium castings, graphite, fiberglass, etc.

Inch (mm)		STC Blade-Pitch Catalog Number	
Width	Gauge	3 TPI	Tooth Style
3/8" (10)	0.025" (0.6)	305-015	Straight
1/2" (13)	0.025" (0.6)	305-020	Straight
3/4" (20)	0.035" (0.9)	305-025	Straight
1" (27)	0.035" (0.9)	305-045	Straight
		305-029	Raker
1 1/4" (34)	0.042" (1.1)	305-326	Raker
1 1/2" (41)	0.050" (1.3)	305-375	Raker

Tungsten Carbide - STW

Catalog # 375

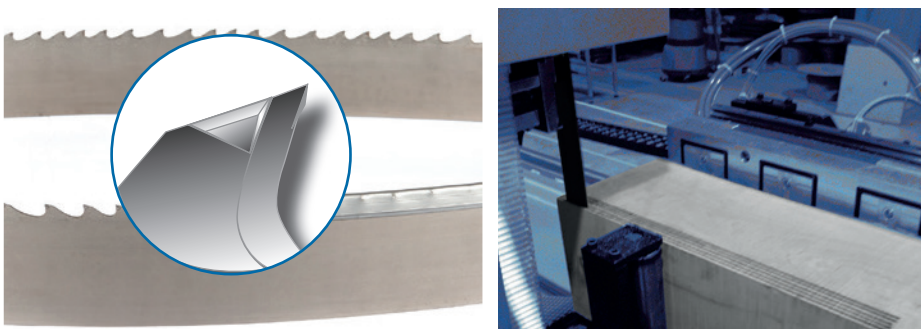

Features:

- Tungsten carbide tooth
- Positive rake angle

Benefits:

- Precise cutting
- Clean cuts
- Straight surface edges

Applications:

- Hard woods like parquet

Inch (mm)		STW Blade-Pitch Catalog Number	
Width	Gauge	2	3
1" (27)	0.035" (0.9)	375-202	375-203
1 1/4" (34)	0.042" (1.1)	375-302	

Carbon Steel - Dart®

Catalog # 308 & 309

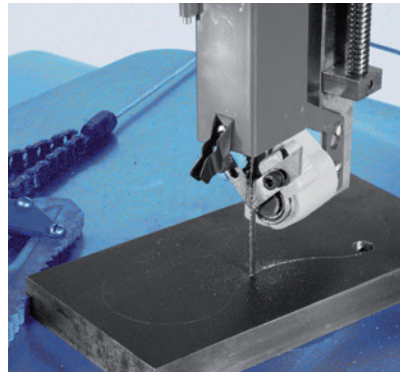
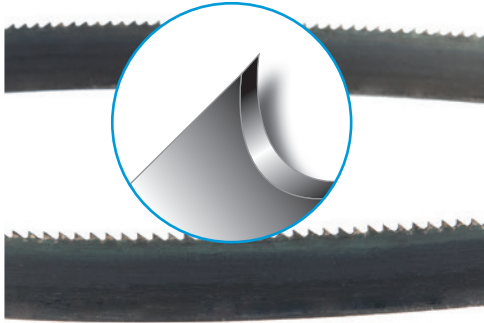

For non-production, highly machinable materials.

Features:

- Carbon steel teeth with flexible hardened back
- Hardened tooth tip

Benefits:

- Accepts high tension
- Resists scoring
- Extended cutting life

Applications:

- Mild steels and other non-ferrous metals, plastics, aluminium and wood
- Perfect for vertical band saw machines

Inch (mm)											
Width	Gauge	2	3	4	6	8	10	14	18	24	32
3/16" (5)	0.025" (0.6)			308-825			308-023	308-049			
1/4" (6)	0.025" (0.6)			309-021*	309-047*		308-080	308-106	308-122	308-148*	308-601
				308-841*							
3/8" (10)	0.025" (0.6)		309-062	309-088	309-104	308-163	308-189	308-205*	308-221*		
				308-908							
1/2" (13)	0.025" (0.6)				308-247		308-262*	308-288*	308-304		
			309-120*	309-146*	309-161*		308-627			308-668	
5/8" (16)	0.032" (0.8)						308-346				
3/4" (20)	0.032" (0.8)				308-403*	308-429*	308-445*	308-486*			
			309-187*		309-203		308-700	308-742	308-767		
1" (25)	0.035" (0.9)		309-229*		308-502*	308-528*	308-544*	308-585*			
		308-973	309-211*								
1 1/4" (32)	0.035" (0.9)		309-260								
1 1/2" (41)	0.050" (1.3)						Special order	Special order			
2" (54)	0.063" (1.6)						Special order	Special order			

Black = Precision Tooth Red = Claw Tooth
 Blue = Wave Set Green = Buttress

Random lengths are standard. Other fixed lengths are available. *Minimum length is 100 ft (30.5m).

Carbon Steel - Metal Master™

Catalog # 334 & 335

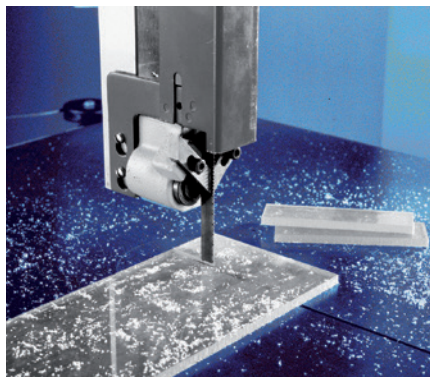
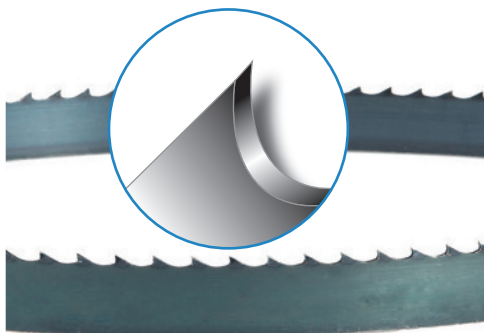

For general purpose sawing of easily machined metal.

Features:

- Carbon steel teeth
- Flexible (unhardened) back
- Hardened tooth tip

Benefits:

- Economical band saw blade

Applications:

- Contour sawing
- Non-ferrous metals, plastics and wood
- First choice for small vertical band saw machines

Inch (mm)		Metal Master Blade-Pitch Catalog Number						
Width	Gauge	3	4	6	10	14	18	24
1/16" (1.6)	0.025" (0.6)							334-043
1/8" (3)	0.025" (0.6)					334-100		
1/4" (6)	0.025" (0.6)		335-348		334-227*	334-243*	334-268	
3/8" (10)	0.025" (0.6)			335-422	334-326*	334-342		
1/2" (13)	0.025" (0.6)	335-488	335-462	335-505*	334-409		334-449	
3/4" (20)	0.032" (0.8)	335-547			334-581*			334-003
1" (25)	0.035" (0.9)	335-620			334-748			

Red = Claw Tooth Random lengths are standard. Other fixed lengths are available. *Minimum length is 100 ft (30.5m).

Carbon Steel - Friction

Catalog # 310

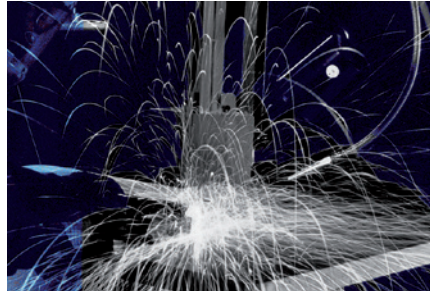
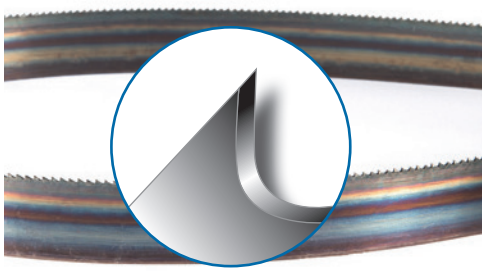

For high speed friction sawing of ferrous metal.

Features:

- Silicon-enhanced carbon steel
- Special wide set
- Hardened tooth tips

Benefits:

- Slower set wear
- Longer fatigue life

Applications:

- Ferrous metals of any hardness up to 1" (25 mm) thick at speeds exceeding 5,000 ft/min (1,524 m/min)

Inch (mm)		Friction Blade-Pitch Cat. Number	
Width	Gauge	8	10
1/2" (13)	0.032" (0.8)		310-037
3/4" (20)	0.035" (0.9)		310-094
1" (25)	0.035" (0.9)	310-134	310-136
1 1/4" (32)	0.035" (0.9)		310-359*

Random lengths are standard. Final coil lengths may vary. *Also available in 300ft (91.4m) and 500ft (152.4m) coils.

Carbon Steel - Olympia™

Catalog # 358

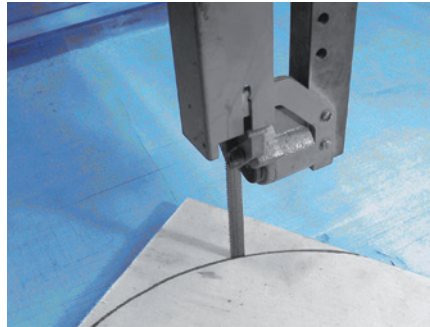
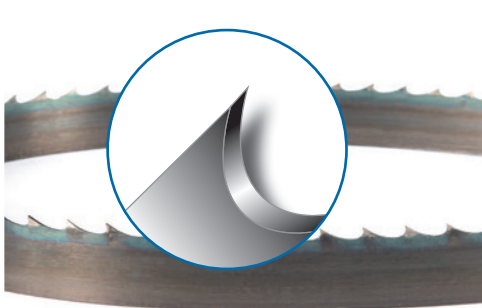

For contour and cut-off sawing of wood.

Features:

- Precision milled tooth form
- Flame hardened tooth tips
- Spring-back hardened raker set
- Claw tooth design

Benefits:

- Long blade life
- Strong blade for accurate contour sawing

Applications:

- Typical woodworking
- Plastics

Inch (mm)		Olympia Blade-Pitch Catalog Number			
Width	Gauge	1.3	2	3	4
1/4" (6)	0.025" (0.6)				358-054
3/8" (10)	0.025" (0.6)				358-118
	0.032" (0.8)		358-104	358-114 or 358-111	
1/2" (13)	0.025" (0.6)			358-152	
	0.032" (0.8)			358-156	
5/8" (16)	0.032" (0.8)		358-211	358-215	
3/4" (20)	0.032" (0.8)		358-252	358-256	
			358-254		
1" (25)	0.035" (0.9)		358-304	358-328	
1 1/4" (32)	0.035" (0.9)	358-356	358-362		
2" (50)	0.035" (0.9)	358-513			

Random lengths are standard. Other fixed lengths are available.

Knife Edge - Straight

Catalog # 313

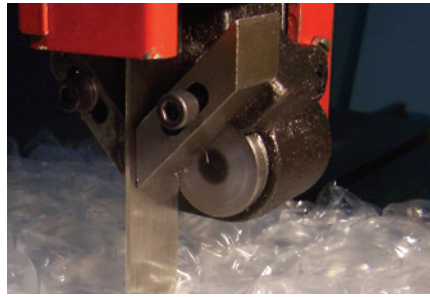
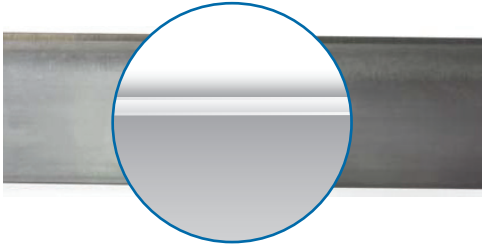

For slicing soft, low density material.

Features:

- Produces no chip or dust

Benefits:

- Slices smoothly
- Clean cutting

Applications:

- For slicing soft, low-density materials like fabrics, sponge and foam

Straight Blade-Pitch Catalog Number						
Millimeter		Inch		Standard Edge		Double Edge
Width	Gauge	Width	Gauge			
				Single Bevel	Double Bevel	Double Bevel
6	0.5	1/4	0.020		313-058	
10	0.4	3/8	0.016		313-130*	313-197**
	0.5		0.018		313-098	313-205**
	0.6		0.020		313-155*	
13	0.5	1/2	0.020	313-221	313-379	313-320**
	0.6		0.025	313-247*	313-387*	
	0.7		0.029	313-262*		
	0.8		0.032		313-312*	
16	0.5	5/8	0.020		313-395	
	0.6		0.025		313-411*	
20	0.4	3/4	0.016	313-403*	313-437*	
	0.5		0.018	313-429*	313-478	313-544
	0.6		0.020		313-486	
	0.8		0.032		313-502	
25	0.5	1	0.018		313-510	
	0.6		0.020		313-577	
	0.8		0.032		313-593	
32	0.5	1-1/4	0.018		313-841	
	0.8		0.032		313-858*	
38	0.5	1-1/2	0.018		313-643	
51	0.8	2	0.032		313-890	

*Minimum order 250 ft (75m)

**Welded lengths only

Available in custom welded lengths or 100 ft (30m) coils. Also available in 250 ft (75m) or 500 ft (150m) coils in strip-out containers on request.

Knife Edge - Honeycomb

Catalog # 314

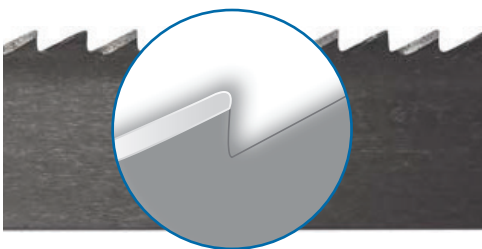

Features:

- Alternately honed teeth slit and spread

Benefits:

- Passes cleanly through honeycomb and medium-firm materials

Applications:

- For cutting expanded honeycomb, expanded aluminum honeycomb, soft wood and corrugated cardboard

Knife Edge Blade-Pitch Catalog Number					
Millimeter		Inch		Pitch 4 TPI	
Width	Gauge	Width	Gauge	With set	No set
13	0.8	1/2	0.032		314-625*
16	0.8	5/8	0.032	314-666*	
20	0.7	3/4	0.030	314-681*	
25	0.8	1	0.032		314-740*

*Minimum order 250 ft (75m)

Available in custom welded lengths or 100 ft (30m) coils. Also available in 250 ft (75m) or 500 ft (150m) coils in strip-out containers on request.

Knife Edge - V-Tooth

Catalog # 315

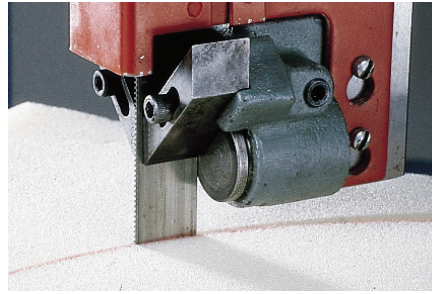
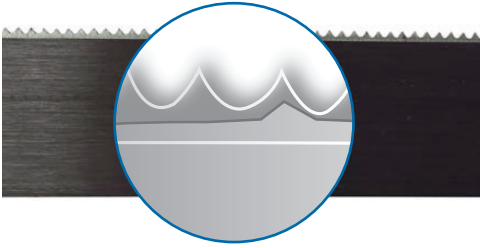

Features:

- V-tooth adds “nibbling” action

Benefits:

- Penetrates soft to medium-firm materials

Applications:

- For sawing soft, medium-density materials
- Soft plastics and firm foams

V-Tooth Blade-Pitch Catalog Number								
Millimeter		Inch		Pitch	Standard Edge		Hard Edge	Double Edge
Width	Gauge	Width	Gauge		Single Bevel	Double Bevel	Double Bevel	Double Bevel
10	0.5	3/8	0.020	10		315-026*		
			0.020	14		315-036		315-697
13	0.5	1/2	0.020	10		315-648		315-796
			0.020	14		315-663		315-978
	0.6		0.025	10		315-275		
16	0.5	5/8	0.020	10			315-564*	
20	0.5	3/4	0.020	14		315-747 or 315-721		315-994
	0.6		0.025	14		315-358*		
	0.8		0.030	10	315-291*	315-325*		
25	0.5	1	0.020	10		315-762		
	0.8		0.030	14		315-671* or 315-788		
32	0.5	1-1/4	0.020	14		315-754		
38	0.5	1-3/8	0.020	14		315-770*		

*Minimum order 250 ft (75m)
Available in custom welded lengths or 100 ft (30m) coils. Also available in 250 ft (75m) or 500 ft (150m) coils in strip-out containers on request.

Knife Edge - Wavy

Catalog # 315

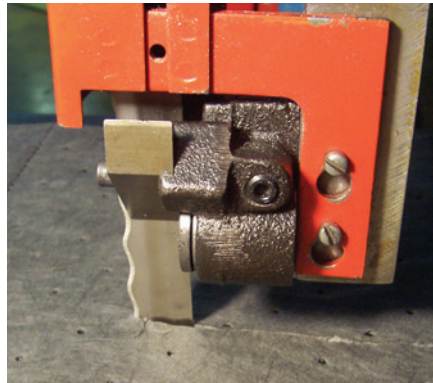
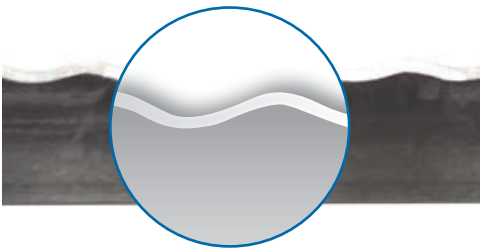

Features:

- Wavy edge eases penetration
- Produces no chips or dust

Benefits:

- Fast cutting
- Clean operation

Applications:

- For enhanced penetration in low-density materials
- For cutting felt and hoses

Wavy Blade-Pitch Catalog Number								
Millimeter		Inch		Pitch	Standard Edge		Hard Edge	
Width	Gauge	Width	Gauge		Single Bevel	Double Bevel	Double Bevel	
6	0.5	1/4	0.020		315-051*			
10	0.5	1/3	0.020			315-101*		
			0.020			315-168		
13	0.5	1/2	0.020			315-189*		
	0.6		0.025			315-184		
16	0.5	5/8	0.020			315-226		
	0.6		0.025			315-242*		
20	0.5	3/4	0.020		315-333	315-341		
	0.6		0.025			315-382*		
	0.7		0.030			315-408*		
25	0.5	1	0.020			315-465	315-465HE	
	0.6		0.025			315-929		
	0.8		0.032		315-499	315-507		
32	0.8	1-1/4	0.032			315-515		

*Minimum order 250 ft (75m)
Available in custom welded lengths or 100 ft (30m) coils. Also available in 250 ft (75m) or 500 ft (150m) coils in strip-out containers on request.

Knife Edge - Scallop

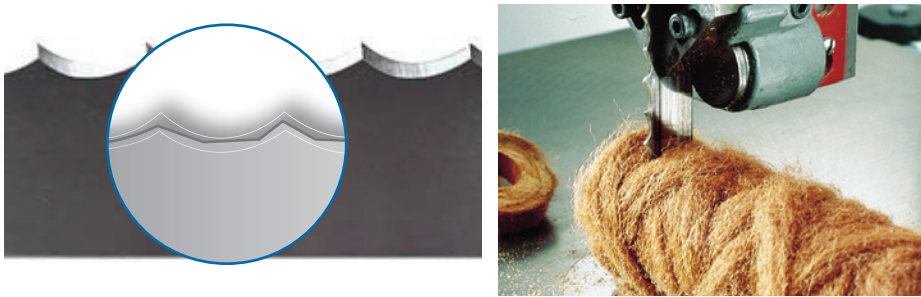

Features:

- Scalloped tips easily impacts and slices soft materials

Benefits:

- Assures penetration of softer materials

Applications:

- For aggressive penetration in medium-density materials
- Dense foam, paperboard and rubber

Scallop Blade-Pitch Catalog Number						
Millimeter		Inch		Standard Edge		Hard Edge
Width	Gauge	Width	Gauge	Standard Edge		Hard Edge
				Single Bevel	Double Bevel	Double Bevel
6	0.5	1/4	0.020	314-039*		
10	0.5	3/8	0.020		314-104*	
13	0.4	1/2	0.016		314-146	
	0.5		0.020		314-161	314-542
	0.6		0.025		314-187	314-567
	0.8		0.032		314-237	
16	0.5	5/8	0.020		314-229	
	0.6		0.025	314-278	314-245	
	0.8		0.032			314-999
20	0.5	3/4	0.020		314-344	314-674*
	0.6		0.025		314-385	
	0.8		0.032		314-476	314-478
25	0.5	1	0.020		314-468	314-419
	0.6		0.025		314-484	314-369
	0.8		0.032		314-500	314-510
32	0.8	1-1/4	0.032		314-955*	
38	0.9	1-1/2	0.035		314-970*	

*Minimum order 250 ft (75m)

Available in custom welded lengths or 100 ft (30m) coils. Also available in 250 ft (75m) or 500 ft (150m) coils in strip-out containers on request.

Superabrasive Grinding Products



Founded in 1946, Greenlee Diamond Tool Company is a leader in the design and manufacture of superabrasive grinding products serving a wide array of industries. For over 70 years, Greenlee Diamond has assisted customers in reducing costs by designing productivity enhancing products based on specific application parameters. Our full line of products includes resin, polyimide, metal, vitrified and electroplated bond systems. We are skilled in the application of natural and synthetic diamond abrasives and all varieties of CBN. We stock a variety of basic wheel forms and accessories including diamond compounds, files, hones, dressing tools and sticks.

We offer diamond band saw blades in a variety of sizes and lengths for any machine type.

Greenlee Diamond Tool – A DoALL Company— has been helping customers optimize their manufacturing productivity through the use of super abrasives over conventional abrasives or other manufacturing methods. Greenlee has the ability to develop that solution for the most demanding and difficult grinding applications.

Call 866-451-3316 or visit www.greenleediamond.com to learn more.

Grit Edge - Tungsten Carbide

Catalog # 325

Continuous edge



Segmented edge



Ideal for sawing abrasive materials.

Features:

- Tungsten carbide grit edge for hard, brittle or abrasive materials
- Continuous edge blades reduce work chipping, especially in thin sections
- Segmented edge blades carry coolant through large work sections

Benefits:

- Easily cuts hardened steels

Applications:

- Hardened steels
- Glass foam
- Car tires
- Friction materials

Inch (mm)		Grit Edge Tungsten Blade Catalog Number			
Width	Gauge	Kerf	Pitch Class	Continuous	Segmented
3/8" (10)	0.025" (0.6)	0.056" (1.42)	Medium		325-175
1/2" (13)	0.025" (0.6)	0.042" (1.07)	Fine	325-332	
		0.056" (1.42)	Medium	325-365	325-357
3/4" (19)	0.032" (0.8)	0.06" (1.52)	Medium coarse		325-373
		0.063" (1.60)	Medium		325-555
1" (25)	0.035" (0.9)	0.067" (1.70)	Medium coarse		325-571
		0.066" (1.68)	Medium	325-746	
1 1/4" (32)	0.035" (0.9)	0.07" (1.78)	Medium coarse	325-779	325-753
		0.042" (1.1)	Coarse		325-837
1 1/2" (38)	0.042" (1.1)	0.07" (1.78)	Coarse		325-852
		0.095" (2.41)	Coarse		325-951
2" (50)	0.042" (1.1)	0.095" (2.41)	Coarse		325-970

Grit Edge - Diamond

Catalog # 406

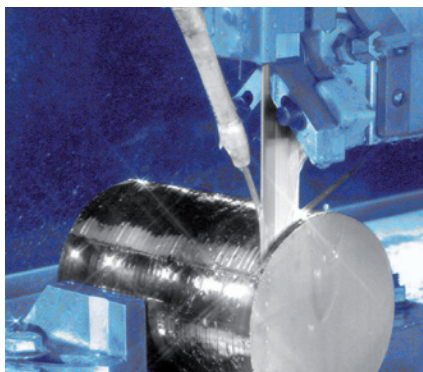

For sawing extremely brittle and abrasive materials.

Features:

- Diamond grit edge
- Continuous for materials up to 1" (25 mm) segmented for large materials

Benefits:

- Cuts the hardest, most brittle, abrasive materials

Applications:

- Silicon, glass, quartz, abrasive composites, hard graphites, carbide, marble, limestone and brake linings
- NOT for steel

Inch (mm)		Type	Diamond Grit Size				
Width	Gauge		30/40	40/50	60/80	100/120	200
1/2" (13)	0.020" (0.5)	Continuous		406-942	406-918	Special order	Special order
3/4" (19)	0.020" (0.5)	Continuous		406-959	406-926	406-750	406-769
		Segmented		406-741	Special order	Special order	Special order
1" (25)	0.040" (1.0)	Continuous	406-422	Special order	Special order	Special order	Special order
		Segmented		406-967	406-934	406-971	Special order
1 1/4" (32)	0.020" (0.5)	Continuous		406-827	406-843	406-846	Special order
		Segmented	406-421	406-552	406-462	Special order	Special order
1 1/2" (38)	0.040" (1.0)	Continuous	406-442	Special order	406-433	Special order	Special order
		Segmented		406-807	406-804	406-802	Special order
2" (50)	0.020" (0.5)	Continuous		406-813			
		Segmented		406-807	406-804	406-802	Special order
1 1/4" (32)	0.040" (1.0)	Continuous	406-428	Special order	406-476	Special order	Special order
		Segmented	406-447	Special order	406-483	Special order	Special order
1 1/2" (38)	0.020" (0.5)	Continuous		406-817	Special order	Special order	Special order
		Segmented	406-480	Special order	Special order	Special order	Special order
2" (50)	0.040" (1.0)	Continuous	406-456	Special order	Special order	Special order	Special order
		Segmented	406-496	Special order	406-830	Special order	Special order
Kerf	Factor	Inch (mm)	0.06" (1.6)	0.04" (0.9)	0.02" (0.6)	0.02" (0.4)	0.01" (0.2)
			406-837	Special order	406-833	Special order	Special order

Special order bands require minimum orders.

To determine approximate kerf add kerf factor to gauge of the band.

Circular



DoALL circular saw blades are designed for use in high performance circular sawing machines with high demands on productivity, accuracy and surface finish.

These saw blades have a special tooth geometry for single use, resulting in a smaller kerf and therefore lower energy consumption and less material loss. The program consists of cermet tooth tip material for general purpose cutting of a wide range of materials. The tungsten carbide tooth tip with coating is a typical pin material dedicated for cutting stainless steel.

Features

- Cermet tooth tips and tungsten carbide tooth tips with coating available
- Small kerf tooth tips
- Tight tolerances on body flatness

Benefits

- Wide range of sawing applications
- High cutting rates, low energy consumption, low material losses
- Less vibration, low noise level, extended blade life, superb surface finish

Applications

- Carbon steel, alloy steel, stainless steel, bearing steel, tool steel

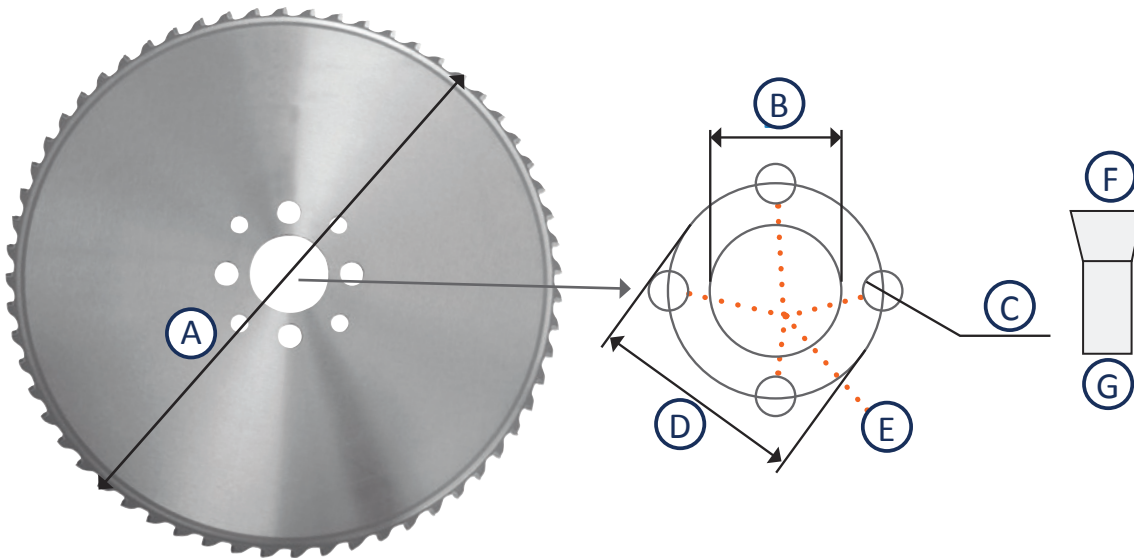

Required information for choosing the right circular blade:

- A. Blade diameter
- B. Bore
- C. Pinhole specification
- D. Pinhole center diameter
- E. Number of pinholes
- F. Kerf
- G. Body
- H. Material type

Popular Blade Sizes*		A	F	G	B
Part #	Specifications	Blade Diameter	Kerf	Body	Bore
DSB-285101	285X2.0(1.7)X32 4/11/63 60T	11.2" (285mm)	2.0mm	1.7mm	32mm
DSB-285104	285X2.0(1.7)X32 4/11/63 100T	11.2" (285mm)	2.0mm	1.7mm	32mm
DSB-360101	360X2.6(2.3)X50 4/15/80 60T	14.2" (360mm)	2.6mm	2.3mm	50mm
DSB-360103	360X2.6(2.3)X50 4/15/80 80T	14.2" (360mm)	2.6mm	2.3mm	50mm
DSB-360104	360X2.6(2.3)X50 4/15/80 100T	14.2" (360mm)	2.6mm	2.3mm	50mm
DSB-360106	360X2.6X40 60T IW-01	14.2" (360mm)	2.6mm	2.3mm	40mm
DSB-360108	360X2.6X40 80T IW-01	14.2" (360mm)	2.6mm	2.3mm	40mm
DSB-360109	360X2.6X40 100T IW-01	14.2" (360mm)	2.6mm	2.3mm	40mm
DSB-420102	420X2.7(2.3)X50 4/15/80 60T	16.5" (420mm)	2.7mm	2.3mm	50mm
DSB-460100	460X2.7(2.25)X50 IW-01 50T	18.1" (460mm)	2.7mm	2.25mm	50mm
DSB-460101	460X2.7(2.25)X50 IW-01 60T	18.1" (460mm)	2.7mm	2.25mm	50mm
DSB-460103	460X2.7(2.25)X50 IW-01 72T	18.1" (460mm)	2.7mm	2.25mm	50mm
DSB-460105	460X2.7(2.25)X50 IW-01 100T	18.1" (460mm)	2.7mm	2.25mm	50mm
DSB-580103	580X3.2(2.7)X80 4/22/120 100T	22.8" (580mm)	3.2mm	2.7mm	80mm
DSB-580106	580X3.2(2.7)X80 4/22/120 160T	22.8" (580mm)	3.2mm	2.7mm	80mm

* Call for more blade sizes.

Selecting the right circular blade:

1. Determine the blade diameter
2. Choose the bore dimension
3. Select the number of teeth
4. Determine the bolt pattern
5. Select the blade coating (coated carbide or cermet)



Blade Characteristics

BLADE GEOMETRY

Terminology

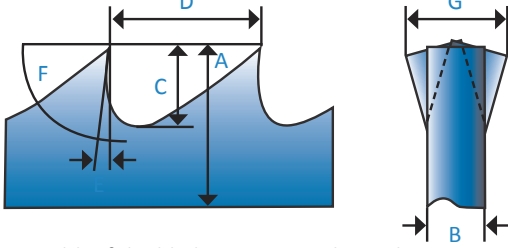

- A. Width of the blade
- B. Thickness (gauge)
- C. Gullet depth
- D. Tooth pitch
- E. Rake angle
- F. Clearance angle
- G. Width of set (kerf)

TOOTH PITCH

Pitch (teeth per inch or TPI) is a measure of tooth spacing.

Single Pitch

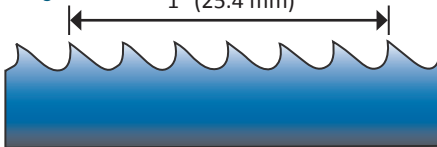

For fast cutting materials. Single pitch blades have consistent tooth spacing. The number of teeth per one-inch length is the TPI.

Multi Pitch

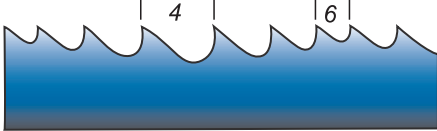

For most metal sawing applications. Multi pitch blades vary tooth spacing between two extremes.

The pitch designation of a multi pitch blade hyphenates the equivalent single pitch designations of those extremes.

TOOTH SHAPES

Tooth forms are combinations of rake angle and gullet shape. Rake angle is a measure of the tooth face inclination to the work. Rake angles are neutral or positive.

Precision

Used for most sawing applications

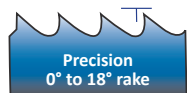

Claw/Hook

Increases beam strength and penetration

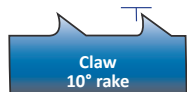

Buttress/Skip

Used for woodworking applications



TYPES OF TOOTH SET

The types of tooth sets is the sequence used in offsetting the teeth.

Raker Set—Sawing ferrous and tough metals



Straight Set—Easily machined metals and non-metals



Straight Raker Set—Used for all multipitch blades



RADIUS CHART

Contour cuts use the widest blade that cut the smallest radius needed for the job. The blade width is measured from the tooth tips to the back edge.

Blade Width 1" (27 mm) Radius 7 1/4" (185 mm)

Blade Width 3/4" (20 mm) Radius 5 1/2" (140 mm)

Blade Width 5/8" (16 mm) Radius 3 3/4" (95 mm)

Blade Width 1/2" (13 mm) Radius 2 1/2" (65 mm)

Blade Width 3/8" (10 mm) Radius 1 1/2" (37 mm)

Blade Width 1/4" (6 mm) Radius 1/2" (15 mm)

Blade Width 3/16" (5 mm) Radius 5/16" (8 mm)

Blade Width 1/8" (3 mm) Radius 1/8" (3 mm)

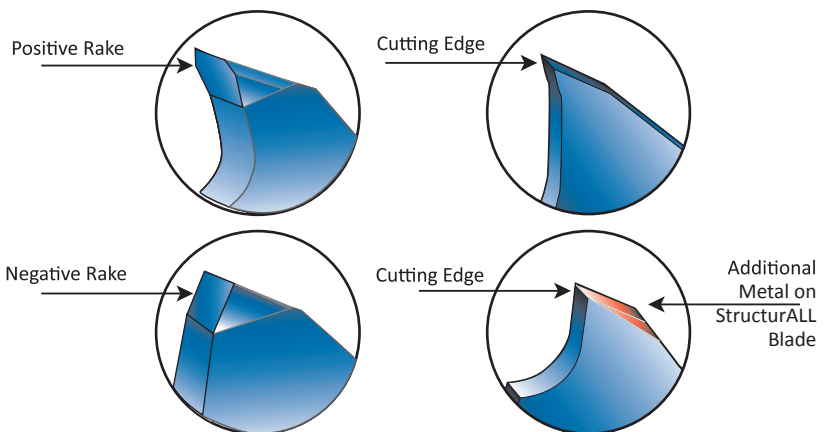

Chip Characteristics

Reading chips provide information on how to improve the efficiency of the blade. For example adjustments can be made to band speed or feed rate.

CHIP FORM								
Condition	Thick, Hard, Short	Thick, Hard, Brittle	Thick, Hard, Springy	Thick, Hard, Springy	Thick, Curly, Springy	Thin, Straight, Springy	Powdery	Thin, Tightly, Curled
Color	Blue or Brown	Blue or Brown	Silver or Light Straw	Silver	Silver	Silver	Silver	Silver
Band Speed	Reduce	Reduce	OK	Reduce Slightly	OK	OK	Reduce	OK
Feed Rate	Reduce	Reduce	Reduce Slightly	Increase Slightly	OK	Increase	Increase	Reduce
Other	Check Cutting Fluid & Mix Ratio	Check Cutting Fluid & Mix Ratio	Check for Correct Blade Pitch	Check for Correct Blade Pitch				Use a Coarser Pitch Blade

Blade Break-in

WHY BREAK-IN A BAND SAW BLADE?

The band saw blade's teeth are razor sharp. In order to withstand the cutting pressures of band sawing, the tooth tip should be honed to form a very small edge radius. If a proper break-in procedure has not been performed and the tooth tips are damaged, the blade life and performance are reduced significantly.

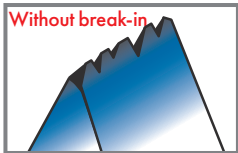
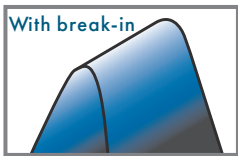
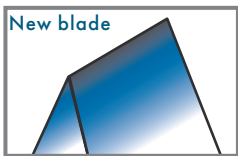

BREAKING IN THE BLADE



Bi-Metal Procedure

1. Reduce feed force during first 20 minutes of cutting to 50% of normal feed.
2. Gradually increase feed force in 4 steps to normal over the course of 10 minutes.
3. Run normal bandspeed.



Carbide Tipped STC / STW Procedure

1. Reduce bandspeed during first 20 minutes of cutting to 70% of normal speed.
2. Reduce feed force during first 20 minutes of cutting to 50% of normal feed.
3. Gradually increase bandspeed and feed force in 4 steps to normal after 10 minutes.



Triple Chip Carbide Tipped T3P / T7P / T3N Procedure

1. Reduce bandspeed during first 20 minutes of cutting to 70% of normal speed.
2. Reduce feed force during first 20 minutes of cutting to 50% of normal feed.
3. Gradually increase bandspeed and feed force in 4 steps to normal after 10 minutes.

Band Saw Blade Selector

Use the chart below to select your band style.

BLADE TYPE	NON-METALS	NON-FERROUS	STEELS AND ALLOYS				Page
			Machinability				
	Wood Plastic Rubber	Aluminium Copper Brass Free machining steels	EASY	MODERATE	DIFFICULT	VERY DIFFICULT	
			Mild steels Low carbon Alloy steels	High carbon Tool steels Die steels	Stainless steels Titanium Nickel based alloys	High nickel alloys Super alloys	
BI-METAL	For highest productivity and lowest costs in most metal sawing applications					4-7	
Silencer GP	Longer wear life		General purpose Bi-Metal blade with longer wearing tooth			4	
Silencer Plus			Best all round choice for multi-purpose applications			4	
StructurALL			Best choice for structural material, tubing and bundles			5	
StructurALL Prime			StructurALL with improved heat and wear resistance			5	
Penetrator			Best choice for most high production sawing applications			6	
Penetrator Prime			Penetrator with improved heat and wear resistance			6	
TIN Penetrator			Penetrator with improved wear resistance			6	
Supreme				Most aggressive with varying tooth height and set		7	
TIN Supreme				Supreme with improved wear resistance		7	
TUNGSTEN CARBIDE	For the toughest and most abrasive applications which generate high cutting temperatures and rapid tool wear					8-9	
T3P		High production rate			Ultimate tooth for the toughest material	8	
T3N				Case hardened rods		8	
T3W			Wave enhanced easily cuts hardened steel, glass foam, car tires and friction materials			8	
T7P				Enhanced penetration		9	
STC	Very abrasive materials, cast aluminium					9	
STW	Hard woods					9	
CARBON STEEL	For easier-to-cut materials which generate little heat or tool wear					10-11	
Dart	Hard back allows high band tension, heavy feed					10	
Metal Master	Lowest cost blade					10	
Friction			Special high-speed sawing of ferrous metals up to 25 mm			11	
Olympia	Wood					11	
KNIFE EDGE	For soft, low density work that can be slit and spread, such as fabric, foam, rubber, leather, corrugated cardboard					12-14	
Straight Edge	Very soft, low density					12	
Honeycomb	Medium firm density					12	
V-Tooth	Soft plastics, firm foam, very soft and thin					13	
Wavy Edge	Felt, hoses					13	
Scallop Edge	Dense foam, rubber					14	
DIAMOND	Hardest, most brittle, most abrasive materials					15	
GRIT EDGE TUNGSTEN	Hard metal (between 45 and 65 Rc), brittle and abrasive materials					15	
CIRCULAR	Ideal for cutting small diameters, short lengths and thousands of parts					16-17	



Band Speed & Group Selector

Common Industry Material Group	AISI (SAE)	Cutting Speed (m/min.)					
		Bi-Metal			Carbide		
	Diameter →	<4" (100 mm)	4"-16" (100-400 mm)	>16" (400 mm)	<4" (100 mm)	4"-16" (100-400 mm)	>16" (400 mm)
	Blade Width →	1 1/4" (34 mm)	1 1/2" (41 mm)	2" (54 mm)	1 1/4" (34 mm)	1 1/2" (41 mm)	2" (54 mm)
		SFPM	SFPM	SFPM	SFPM	SFPM	SFPM
Structural Steels	1015	230-295	200-260	165-230	395-525	360-492	330-460
	ASTM-A570	145-200	130-180	130-175	295-395	275-395	310-410
Free Machining	1112/1212	200-260	165-213	165-208	395-525	360-492	395-525
Cementation Steels	1010/1015	200-260	165-213	165-208	395-525	360-492	395-525
	5115	130-165	115-150	115-150	245-330	245-330	245-330
		130-165	115-150	115-150	245-330	245-330	245-330
	8620	130-165	115-150	115-150	245-330	245-330	245-330
Bearing Steels	52100	114-150	98-130	98-130	230-310	230-295	213-295
Spring Steels	9260H	114-165	98-150	98-150	230-310	230-310	230-310
	6150	114-165	98-150	98-150	230-310	230-310	230-310
Hot Working Steels and Case Hardened Steel	1035/1045	150-200	130-180	130-180	295-410	275-395	310-410
	4140	130-492	114-150	35-160	254-345	246-330	246-340
	4337	82-114	75-100	78-108	165-230	165-223	180-246
Nitriding Steel	H21	78-104	68-91	75-101	157-213	150-206	167-226
High Alloyed Hot Working Steels		85-114	75-101	78-108	167-230	165-223	176-241
	H13	78-106	68-91	75-101	157-213	150-206	167-226
	L6	85-114	75-101	78-108	167-230	165-223	177-246
Unalloyed Tool Steels	W112	111-150	101-134	101-134	226-305	223-301	223-301
	W108	111-150	101-134	101-134	226-305	223-301	223-301
Cold Working Steels	D3	65-88	62-85	55-75	131-180	124-170	137-187
	D2	65-88	62-85	55-75	131-180	124-170	137-187
		111-150	101-134	101-135	226-301	223-301	223-301
High-Speed Steels	M2	95-127	85-114	78-108	177-242	190-255	190-255
		95-128	85-115	78-109	177-243	190-255	190-255
	M42	95-129	85-116	78-110	177-244	190-255	190-255
		95-130	85-117	78-111	177-245	190-255	190-255
Cast Iron	T1	95-131	85-118	78-112	177-246	190-255	190-255
	A48	101-134	85-118	85-118	200-272	173-232	173-232
A536		101-135	85-118	85-118	200-273	173-232	173-232
	303	108-134	85-114	91-127	196-265	170-229	187-252
Stainless Steels	304	108-135	85-115	91-128	196-266	170-230	187-253
	316Ti	75-101	65-85	68-95	147-200	127-173	141-190
	316	75-102	65-85	68-95	147-200	127-173	141-190
	420	88-118	78-104	88-118	177-239	157-213	206-236
		88-118	78-104	88-118	177-239	157-213	206-236
Heat Resistant Steels	HNV3	78-104	68-91	75-101	157-213	150-206	167-226
	661	49-68	39-55	42-59	101-134	78-108	85-114
	616	88-118	78-104	88-118	177-239	157-213	177-236
	314	49-68	39-55	42-59	101-134	78-108	85-114
	330	49-68	39-55	42-59	101-134	78-108	85-114
	334	49-68	39-55	42-59	101-134	78-108	85-114
		49-68	39-55	42-59	101-134	78-108	85-114
Nickel Base Alloys	5596E(AMS)	32-42	29-39	32-42	65-85	55-75	65-88
	5660J(AMS)	32-42	29-39	32-42	65-85	55-75	65-88
	5872D(AMS)	32-42	29-39	32-42	65-85	55-75	65-88
Aluminium		311-377	328-393	328-393	574-656	574-656	557-738
Copper	AA1100	311-377	328-393	328-393	574-656	574-656	557-738
Brass	CDA110	164-229	131-196	114-147	328-459	262-392	229-298
Alu-bronze	CuZn39Pb1AlB-B	239-360	239-360	278-377	574-656	575-656	557-738
Titanium Alloys	Ti-6Al-4V	42-75	32-65	32-49	131-164	131-164	114-147
Steels with Tensile Strength More Than 1,000 N/mm2	1000-1200 N/mm2	82-98	82-98	65-82	197-229	164-196	131-164
	1200-1400 N/mm2	98-180	65-82	49-65	164-196	131-164	98-131
	1400-1600 N/mm2	65-82	49-65	32-49	131-164	98-131	65-98

Pitch Selector for Solid Material

The pitch indicates the tooth spacing. The correct pitch choice ensures proper tooth pressure and adequate gullet capacity for chips. In most applications, a blade should engage no less than 3 teeth and no more than 25 teeth in the cut.

SINGLE PITCH

- Single pitch blades have uniform tooth spacing and shape
- Pitch (teeth per inch) is the number of gullets in a 1" (25.4 mm) span
- Use primarily for solids on rigid machines

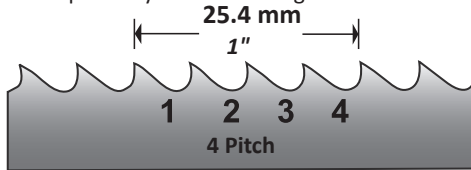

MULTI PITCH

- Multi pitch blades have a varying tooth spacing to reduce vibrations.
- Pitch designation hyphenates single pitches of coarsest and finest teeth.
- Use for most sawing applications
- Best for structural materials or any vibration-prone application

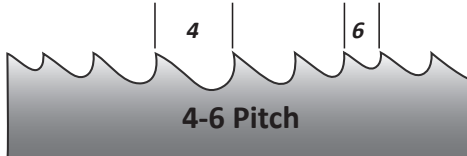

		Workpiece Size In Diameter for Bi-Metal Blades																									
Inches	1/8	1/4	3/8	1/2	1	2	2.5	3	4	5	6	8	10	12	14	16	20	24	28	32	36	40	48				
mm	3	6	10	15	30	45	60	80	100	120	150	200	250	300	350	400	500	600	700	800	900	1000	1200				
TPI	10 - 14					8 - 12		6 - 10			5 - 8		4 - 6		3 - 4			2 - 3			1.5 - 2			1 - 1.5		0.8 - 1.2	



		Workpiece Size In Diameter for Tungsten Carbide Blades															
Inches	2.5	3	4	5	6	8	10	12	14	16	20	24	28	32	36	40	
mm	60	80	100	120	150	200	250	300	350	400	500	600	700	800	900	1000	
TPI	3 - 4					2 - 3				1.3 - 2				0.7 - 1			

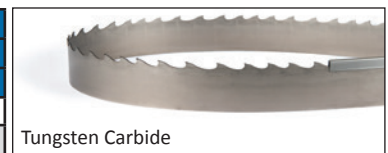

Helpful Hints When Choosing Blades:

- For fast, accurate sawing, choose the widest blade that fits the machine
- For contour sawing, choose the widest blade that will cut the smallest part radius
- Consider a single pitch blade for fast cutting materials as single pitch blades have consistent tooth spacing
- Use a multi pitch blade for most metal sawing applications where harmonics need to be controlled

Better Results Will Come from Following DoALL Blade Expert Advice:

- Thinner blade option for longer flex life over small band wheels
- Thicker blade option for straighter cuts under heavy feed force
- Standard set for most applications
- Wider (heavier) set to avoid pinching in highly stressed metals
- Raker set for sawing ferrous and tough metals
- Straight set for easily machined metals and non-metals
- Straight raker set is used for all multi pitch blades
- Precision tooth shape for most sawing applications
- Claw/hook tooth shape to increase beam strength and penetration
- Buttress/skip tooth shape for woodworking applications
- Neutral rake blade for most work narrower than two inches
- Positive rake blade for wider, tougher-to-penetrate work

Pitch Selector for Structural Material

This selector can be used to easily find the correct pitch for cutting profiles and tubing.

Step 1.

Select the maximum dimension of the part to be cut on the horizontal scale.

Step 2.

Then check on the vertical column the wall thickness measured and find the advised pitch in the table.

Step 3.



For faster cutting, the next larger pitch can be used.

Note: It is not advised to use a finer pitch as the overfilling gullets will break the teeth.

Cutting in Bundles

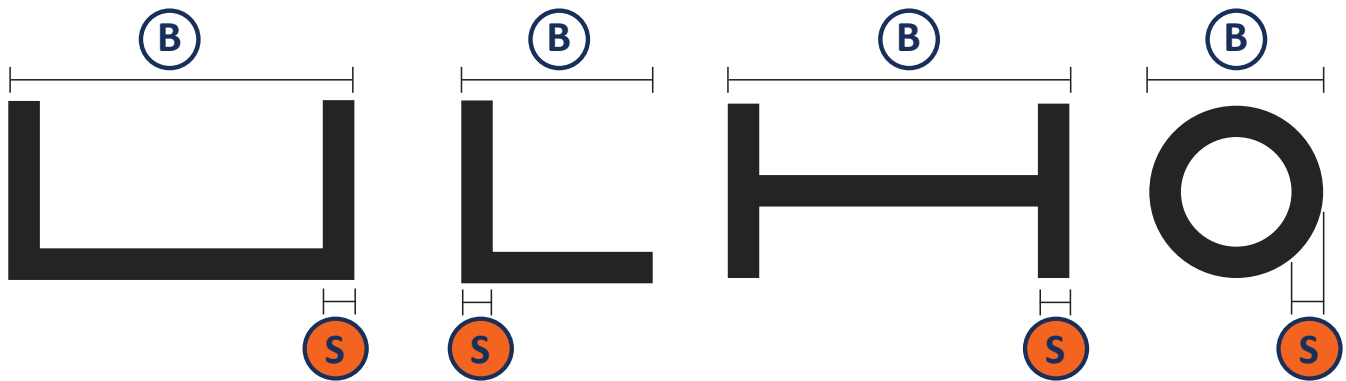
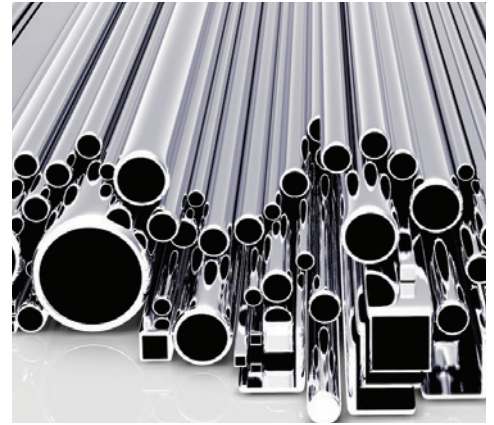
For round tubing double the single wall thickness and find the correct pitch. For square and rectangular tubing take into consideration the maximum distance to cut in the bundle and the combined wall thickness.



Recommended blade pitch												
 Wall thickness in inch (mm)	 TPI (teeth per inch) Dimension in inch (mm)											
	inch (mm)	3/4" (20)	1 1/2" (40)	2 1/2" (60)	3" (80)	4" (100)	5" (120)	6" (150)	8" (200)	12" (300)	20" (500)	30" (750)
1/16" (2)	10 - 14	10 - 14	10 - 14	10 - 14	10 - 14	10 - 14	10 - 14	10 - 14	8 - 12	6 - 10	5 - 8	5 - 8
1/8" (3)	10 - 14	10 - 14	10 - 14	10 - 14	10 - 14	10 - 14	8 - 12	8 - 12	6 - 10	5 - 8	4 - 6	4 - 6
3/16" (4)	10 - 14	10 - 14	10 - 14	10 - 14	8 - 12	8 - 12	6 - 10	6 - 10	5 - 8	4 - 6	4 - 6	4 - 6
7/32" (5)	10 - 14	10 - 14	10 - 14	8 - 12	6 - 10	6 - 10	6 - 10	5 - 8	4 - 6	4 - 6	4 - 6	3 - 4
1/4" (6)	10 - 14	8 - 12	8 - 12	8 - 12	6 - 10	6 - 10	5 - 8	5 - 8	4 - 6	4 - 6	3 - 4	3 - 4
5/16" (8)		6 - 10	6 - 10	6 - 10	5 - 8	5 - 8	5 - 8	4 - 6	4 - 6	3 - 4	3 - 4	3 - 4
3/8" (10)		6 - 10	6 - 10	5 - 8	5 - 8	5 - 8	4 - 6	4 - 6	4 - 6	3 - 4	3 - 4	3 - 4
1/2" (12)		5 - 8	5 - 8	5 - 8	4 - 6	4 - 6	4 - 6	4 - 6	3 - 4	3 - 4	2 - 3	2 - 3
5/8" (15)			5 - 8	4 - 6	4 - 6	4 - 6	3 - 4	3 - 4	3 - 4	2 - 3	2 - 3	2 - 3
3/4" (20)			4 - 6	4 - 6	4 - 6	3 - 4	3 - 4	3 - 4	2 - 3	2 - 3	2 - 3	2 - 3
1" (30)				3 - 4	3 - 4	3 - 4	2 - 3	2 - 3	2 - 3	2 - 3	1.5 - 2	1.5 - 2
2" (50)					3 - 4	3 - 4	2 - 3	2 - 3	2 - 3	1.5 - 2	1.5 - 2	1.5 - 2
3" (75)								1.5 - 2	1.5 - 2	1.5 - 2	1.5 - 2	1 - 1.5
4" (100)									1.5 - 2	1 - 1.5	1 - 1.5	1 - 1.5
6" (150)										1 - 1.5	1 - 1.5	1 - 1.5
8" (200)										1 - 1.5	1 - 1.5	1 - 1.5

Metal Cutting Band Saws

DoALL® Sawing was founded in 1927 by Leighton A. Wilkie, who invented and manufactured the first metal cutting band saw in 1933. We continue to be a global leader for ALL your sawing needs! DoALL provides manual, semi-automatic and automatic metalworking band saws.

Even though we specialize in metal cutting band saws, our legacy continues to parts and service as well. DoALL Sawing Products offers a complete line of service, replacement and repair parts for our current line of band sawing machines. Our skilled team of service professionals – spread across United States and around the globe – are trained in service and repair of the entire line of DoALL band saws as well as competitive machines.



Cutting Fluids

DoALL Sawing Products has been manufacturing cutting and grinding fluids since the 1950s. We offer a broad range of cutting oils like synthetics, semi-synthetics, soluble oils and straight oils. Our product line also includes grinding fluids, direct application machine tool lubricants, metalworking and machining coolants and lubricants, hydraulic, transmission, gear, way and spindle oils. We also promote specialty fluids like cleaners, removers, tank additives, aerosols, mists and Minimal Quantity Lubrication (MQL) lubricants. DoALL Sawing Products has a knowledgeable sales team and distributor network that market metalworking cutting products worldwide. DoALL is committed to providing customers with high quality, cost-effective performance fluids to improve operations and reduce costs. At DoALL, we are dedicated to offering environmentally friendly and worker safe solutions to meet all your machining needs.



At Your Service!

We have our own team of engineers and factory authorized distributors around the world who are saw blade focused who manage their own weld centers. They are able to provide technical support and fast response to any issue.

We are committed to your satisfaction and look forward to serving you.



Additional Sawing Resources



DoALL replacement and repair parts are now available 24-hours a day online at www.DoALLsaws.com/store



Ask about our DoALL University training program and sharpen your skills today! Class includes: Four hour training on the three elements of sawing (machines, blades and fluids)



Free Sawing Analysis: DoALL offers complimentary saw inspections and sawing efficiency analysis. Visit DoALLsaws.com/free-sawing-analysis



5505 West 123rd Street
Savage, MN 55378 USA
www.DoALLsaws.com
1-888-362-5572

Copyright © 2019 DoALL Sawing Products. Catalog Number DSP-BLADES-020419
All Rights Reserved. No image(s) or part(s) from this publication may be reproduced without the written permission of Continental Machines, Inc. Options, specifications and any product information is subject to change without notice or obligation. Machine safety items may be omitted for illustration purposes only – For proper application, always read the operation manual. Images of products and products in use are meant to be representative and may change without notice. DoALL, DART, IMPERIAL, MATRIX, METAL MASTER, OLYMPIA, PENETRATOR, SILENCER, StructurALL, SUPREME and Sam – The Sawing Answer Man are all either registered trademarks or brand trademarks of DoALL Company.