

# CoroDrill® DS20

What innovation looks like

## Indexable drilling up to $7 \times DC$

Innovative drill body and insert designs have resulted in a drilling concept with never-before-seen stiffness, evacuation performance and light cutting action.

CoroDrill® DS20 reaches hole depths from 4 up to  $7 \times DC$  and offers reliability, predictability and outstanding penetration rates. Improve your drilling operations even more and reduce your tool inventory by using the stable and high precision Modular Drilling Interface, MDI.



# Strong drill body

The design of the CoroDrill® DS20 has resulted in a strong and fatigue-resistant drill body where each drill body size is individually optimized to ensure a secure and consistent performance over the entire assortment.

The drill body stiffness, in combination with light-cutting geometries, generates less vibration and significantly increased tool life.

With high process security and good run-out accuracy, CoroDrill® DS20 will reduce your costs and increase your component quality.

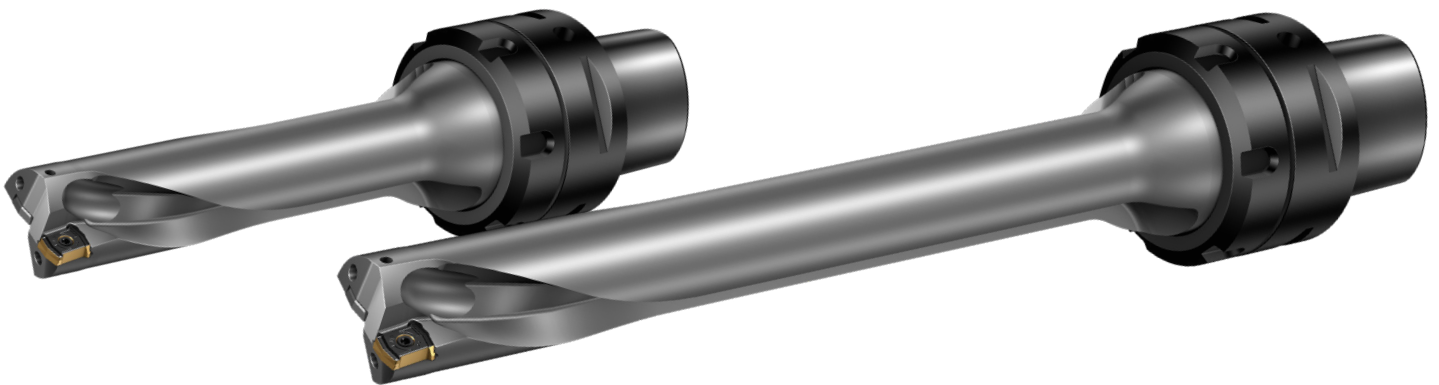

## 4–5 × DC

- Plug and play
- Predictable and consistent chip control
- Versatile and cost-efficient
- Increased productivity in all materials
- Large functionality over a broad cutting data range
- H12–H13 hole tolerances

## 6–7 × DC

- First to market with a 7 × DC indexable insert drill
- Cost-efficient drilling for deeper holes with less demanding hole tolerances
- Opens up for new machining processes with increased productivity
- No pilot drilling needed

## Twisted coolant holes

CoroDrill® DS20 is designed with variable twisted coolant holes which allow for maintained drill body rigidity.

The coolant outlets are strategically placed to ensure best possible coolant flow and direction. With more coolant on the clearance side, a longer insert tool life and better chip evacuation can be achieved.

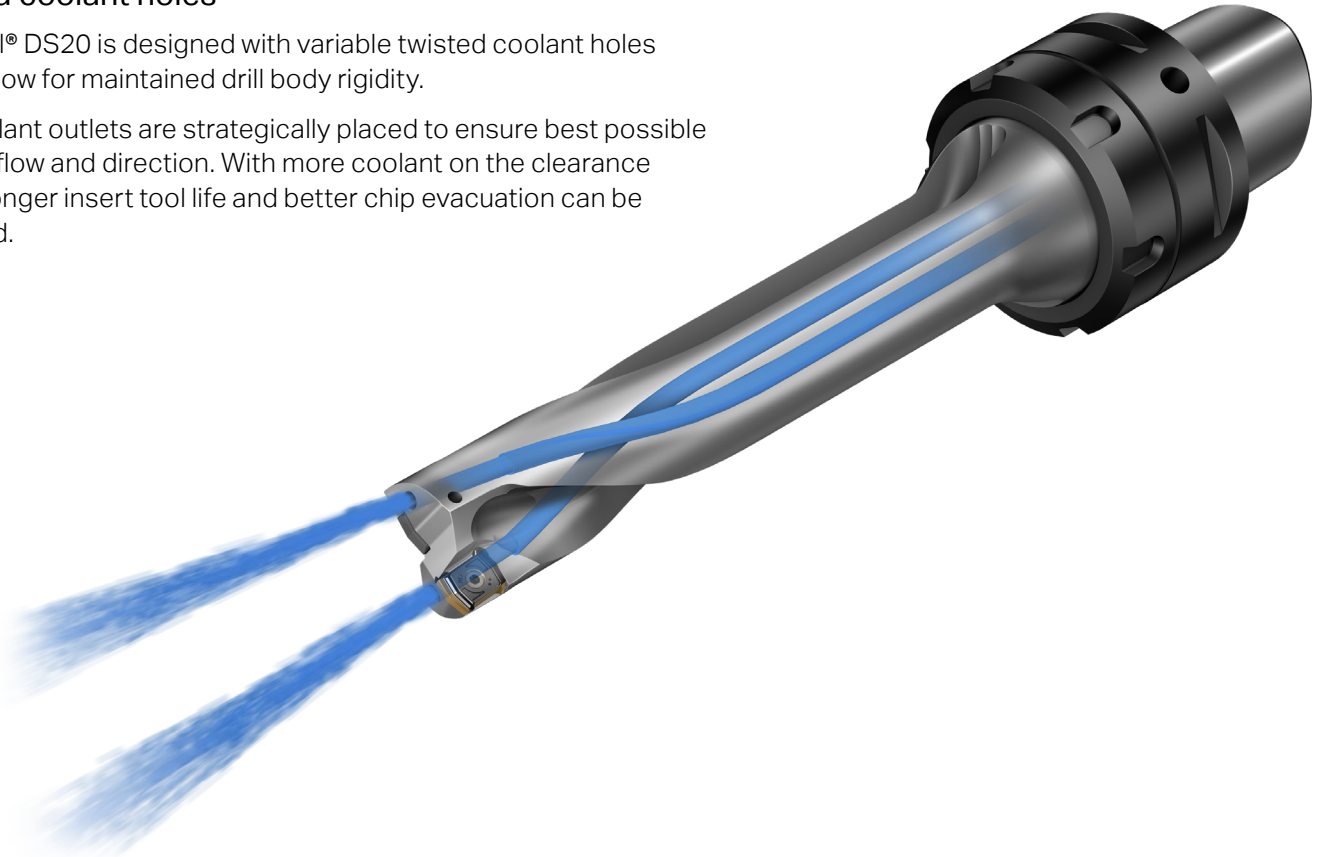

## Optimized chip flutes

The chip flutes are individually shaped for optimized chip evacuation of the peripheral and central inserts different chip forms. All chips created fits inside the flutes.

The different shaped flutes help to control the rotational centre and the deflection of the drill when axial forces are applied.

To maintain drill body stiffness and for a balanced mass centre, the chip flutes are also individually designed for each drill size.

The square profile adds rigidity while the variable helix secures good chip evacuation, leading to less vibration, predictable wear patterns and increased tool life.





# An insert for every application

With three support contact surfaces in each insert seat, there are less insert movements leading to longer tool life and better hole surface.

The inserts are strong and have a bulk strength that provides extra toughness resulting in unmatched insert tool life.

Closer hole tolerances can be achieved thanks to the ground dog-bone shaped peripheral insert. This double-sided positive insert, with a negative insert position, directs the cutting forces into the drill body resulting in higher stability and consistent performance.

## Grades and geometries

Grades are available for all materials and applications. The PVD-coated grade GC1344, produced with Zertivo® coating process technology, offers excellent wear resistance and toughness for central inserts.

A large selection of geometries is available. With the versatile geometry -L6W it is possible to use the same tool in many operations and materials.

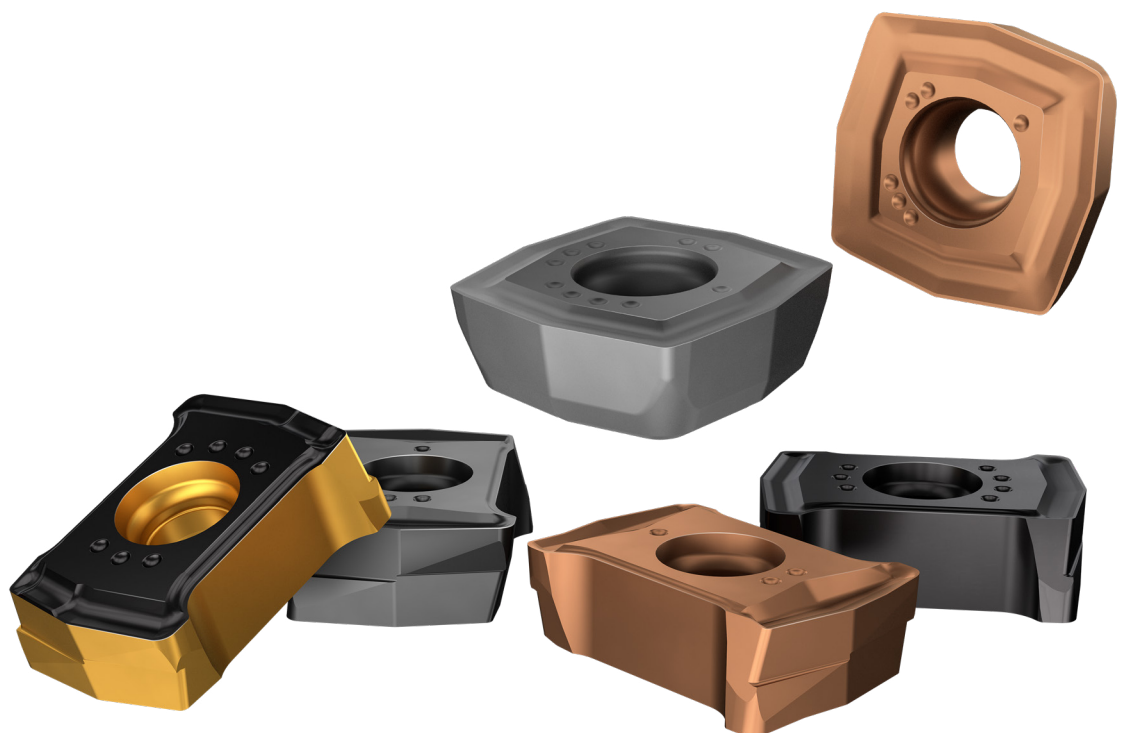

## Next generation step technology

Entering the workpiece with an asymmetrical drill by default generates an unbalance. The new generation of inserts with double steps allow for softer entries and cutting forces are considerably reduced at entry.

In combination with the stiff drill body, the centring capabilities are dramatically improved enabling deeper holes to be drilled, higher productivity as well as closer hole tolerances.



## Customer benefits

- Secure and reliable cutting process with high productivity ensuring low cost per hole
- Versatile drill with good chip formation in a broad cutting data range
- Large selection of geometries, from versatile to optimized offer
- Optimized chip control and chip evacuation
- Consistent and predictable hole diameter
- Light cutting with low cutting forces
- Reduced sound level



# MDI (Modular Drilling Interface)

The patented MDI coupling is a stable and high precision modular drilling interface that provides excellent centring capabilities.

One size can be used for several drill diameters leading to less tool inventory and lower costs. In addition, MDI offers quick and easy set-up.

Four locating pins allow for high torque transmission and provide an exact cutting edge position. The position of the locating pins makes it possible to rotate the drill 180° which can be beneficial in poor machine conditions, for example in misaligned or unstable lathes.

With two different diameters on shank and adaptor, double centring with high fitting accuracy is possible. In combination with flange and surface contact between drill body and nut, increased stability, good run-out precision and optimal repeatability can be achieved.



Coromant Capto®

HSK-T

## Performance

### Customer case

<b>Component:</b>	Gear ring, 91 holes
<b>Material:</b>	34CrMoNi4, P2.5.Z.HT, 240 HB
<b>Operation:</b>	Through hole, Ø39 mm (1.54 inch), depth: 229 mm (9 inch)
<b>Machine:</b>	Vertical machining centre, ISO 50 taper, 20 bar (290 PSI)

**+100%**  
Tool life

**+84%**  
increased  
productivity

	Competitor	Sandvik Coromant
Tool	-	DS20-D3900L40-06
Insert	-	DS20-0508-C-M7 1344 DS20-0508-P-M7W 4334
$v_c$ , m/min (ft/min)	104 (341)	160 (525)
$n$ , rpm	850	1300
$v_f$ , mm/min (in/min)	108 (4.25)	198 (7.80)
$f_n$ , mm (inch)	0.127 (0.005) 0.08 (0.003) at entry/exit, 3 mm (0.118 inch)	0.152 (0.006) 0.11 (0.004) at entry, 3 mm (0.118 inch) 0.06 (0.002) at exit, 5 mm (0.197 inch)
Time in cut, min	127.4	69.2
MRR, cm <sup>3</sup> /min (in <sup>3</sup> /min)	129 (7.87)	237 (14.5)
Tool life, pcs	Unstable tool life, approximately 1/4 ring per insert edge	1/2 ring per tool insert edge

**Result:** With CoroDrill® DS20, the customer got a secure and predictable drilling process with good surface quality, better tool life and less insert set-up time.



## Application

- For hole depths 4–7×DC
- Geometries designed for versatility or optimized applications
- Capable of both non-rotating and rotating set-ups
- Can be used for drilling with radial offset, deburring and back boring

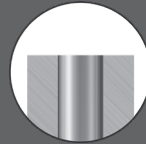

Conventional drilling

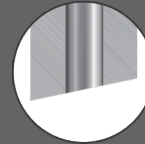

Inclined exits

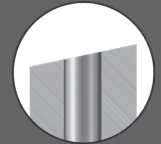

Inclined surfaces

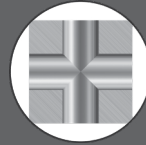

Cross holes



Convex/concave surfaces



Step and chamfer

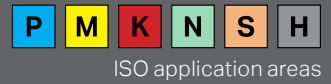

For more information and assortment, contact your local Sandvik Coromant representative or visit [www.sandvik.coromant.com/corodrills20](http://www.sandvik.coromant.com/corodrills20)

Head office:  
AB Sandvik Coromant  
SE-811 81 Sandviken, Sweden  
E-mail: [info.coromant@sandvik.com](mailto:info.coromant@sandvik.com)  
[www.sandvik.coromant.com](http://www.sandvik.coromant.com)

C-2940-167 en-GB © AB Sandvik Coromant 2019

**SANDVIK**  
Coromant