

# WEILER



Third Edition

Solutions for Cutting, Grinding, Cleaning and Finishing.





We are Weiler: Cresco, PA Headquarters

If you think Weiler is an old fashioned wire brush manufacturing company, you'd be dead wrong. In fact, today Weiler is a global abrasives leader with customers in over 80 countries and nearly 1,500 employees around the world.

Headquartered in the beautiful Pocono Mountains of Pennsylvania, we are proud of the fact that we have built a **progressive, innovative, and high growth company** headquartered right here in the USA. Our world class products are designed and built by Weiler Co-Workers who embrace our commitment to customers, the community, and to one another.

Weiler Abrasives Group's **heritage dates to 1879**. Today, the tradition of excellence continues under the leadership of the fourth generation, Chris Weiler, President/CEO. Having grown from a power brush manufacturer to a global surface conditioning problem-solver, Weiler's mission is to partner with our customers and business partners to ensure their businesses stay productive and profitable. Our people, products and our strong desire to win deliver a competitive edge that creates growth.



*For those who want a competitive edge and value productivity-enhancing solutions for cleaning, grinding, cutting, deburring and finishing, Weiler is a premier manufacturer who forges collaborative, problem-solving relationships with our customers.*

## SOLUTIONS FOR ...

### METAL FABRICATION



Time is money. The more time spent building a product, the more it costs. And every step adds time. Grinding. Cutting. Cleaning. Finishing.

You want solutions to get the job done. Done right — but done fast.

#### **Weiler hears you.**

Before, during and after the weld, we have you covered. Superior performance means maximum aggression and long life. Saving more time. For more productivity. And more profit.

#### **That's the Weiler difference.**

### INDUSTRIAL PRODUCTION



There may be hundreds of differences between your industrial production operation and a competitor's. The ones that matter to you are far fewer.

#### **Cost. Quality. Delivery.**

Weiler helps sharpen your competitive edge. Like every production operation is different, so is every production challenge. One solution does not fit all. Weiler experts can examine your specific deburring and cleaning challenges and recommend customized solutions—solutions designed to optimize your operation.

Those solutions can reduce costs. Improve quality. Shorten delivery. And make your competition ... less competitive.

#### **Don't compromise. Optimize. With Weiler.**

### MAINTENANCE, REPAIR & OPERATIONS



The facility doesn't run itself. In fact, keeping things going is more than a full-time job. So you depend on MRO supplies to be ready at a moment's notice — if not before.

Weiler has you covered. We know that when certain products are out of stock, certain activities come to a stop. You aren't going to let that happen on your watch — and neither are we.

No matter where you need them. No matter what they are. If they're Weiler products, they're only a click or a phone call away.

#### **You keep the shop running — Weiler stands ready.**



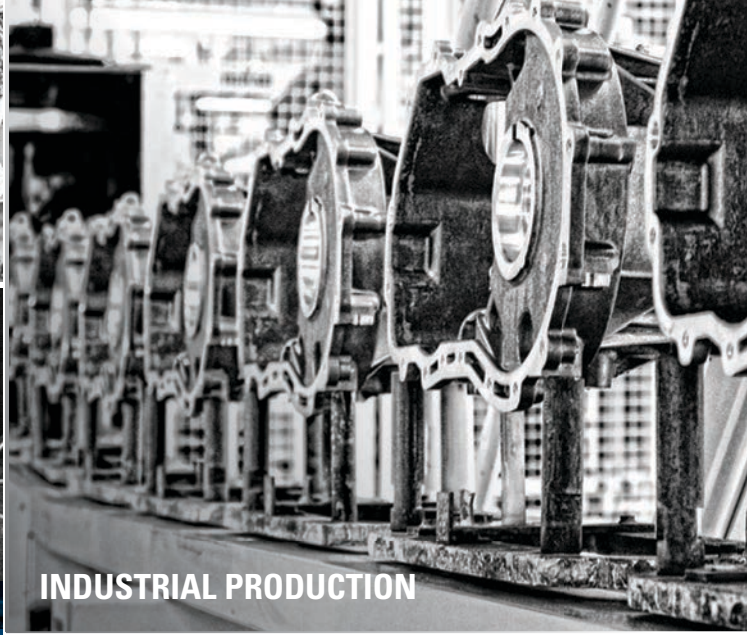

## INDUSTRIAL PRODUCTION



## MRO

Weiler works in various industrial settings across the globe to solve tough challenges, enabling businesses like yours to get more done, more efficiently.

Electronics  
Railway  
Steel  
Aircraft  
Construction  
Painting  
Food Processing  
Pipeline  
Transportation

Heavy Equipment  
Welding  
Pharmaceutical  
Nuclear  
Trucking  
Ship Building  
Petroleum  
Farming  
Automotive

Biomedical  
Aerospace  
Building Products  
Recreational  
Vehicles  
Agricultural  
Equipment  
Machining  
Fabricating



## METAL FABRICATION





**PRODUCT SELECTION GUIDE: BY SURFACE FINISH**

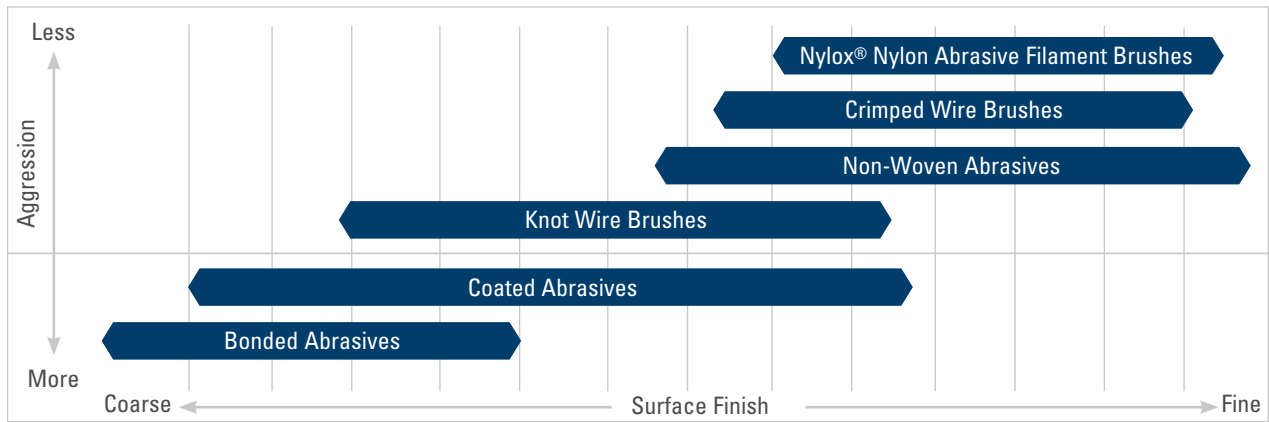

# TABLE OF CONTENTS

## BONDED ABRASIVES .....9-21

Technical Information.....10-13  
 Cutting Wheels.....14-17  
 Grinding Wheels.....18-19  
 Cup Rocks.....19  
 Combo Wheels.....20-21  
 Pipeline Wheels.....21

## COATED ABRASIVES .....22-48

Technical Information.....24-27  
 Abrasive Flap Discs.....28-41  
 Resin Fiber Discs.....42-43  
 AL-tra CUT™ Discs.....43  
 Blending Discs.....43-44  
 Trim-Kut® Discs.....45  
 Flap Wheels.....46-47  
 Shop Rolls.....48

## NON-WOVEN ABRASIVES .....49-52

Technical Information.....50  
 Unitized Wheels.....50  
 Flap Wheels.....51  
 Hand Pads.....51  
 Surface Conditioning Discs.....52

## POWER BRUSHES .....53-101

Technical Information.....54-62  
 Knot Wire Wheels.....63-69  
 Weld Cleaning Brushes.....68-69  
 Crimped Wire Wheels.....70-77  
 Nylon & Tampico Wheels.....78  
 Cup Brushes.....79-81  
 Stem-Mounted End Brushes.....82-85  
 Crosshole Deburring Brushes.....86  
 Power & Hand Tube Brushes.....87-91  
 Miniature Brushes.....92-93  
 Non-Sparking Brushes.....94-95  
 Strip Brushes.....96-99  
 Wide Face Brushes.....100-101

## NYLOX® BRUSHES .....102-130

Technical Information.....104-114  
 Engineered Products & Solutions.....113  
 Troubleshooting Guide.....114  
 Small Feature Deburring Products.....115-119  
 Flat Surface Deburring Products.....120-123  
 Targeted Feature Deburring Products.....124-126  
 Application Engineered Wheels.....127  
 Adapters & Drive Arbors.....128-129  
 FME Area Product Solutions.....130

## PACKAGED PRODUCTS .....131-141

Vending-Ready Products.....131-135  
 Display Packaged Products.....136-141

## MAINTENANCE .....142-177

Technical Information.....144-145, 170  
 Brooms, Sweeps & Handles.....146-153  
 Upright Brooms, Dusters & Dust Pans.....154-155  
 Squeegees & Window Brushes.....156  
 Vehicle Care Products.....157  
 Scrub Brushes.....158-160  
 Mops & Accessories.....161-162  
 Masonry & Applicator Brushes.....163-164  
 Scratch Brushes.....165-167  
 Flue Brushes.....168  
 Tube Fitting Brushes.....169  
 Paint & Parts Cleaning Brushes.....171-173  
 Chip & Oil Brushes.....174  
 Marking Brushes.....175  
 Glue & Acid Brushes.....176  
 Paint Rollers & Accessories.....177

WHY WEILER  
 BONDED ABRASIVES  
 COATED ABRASIVES  
 NON-WOVEN ABRASIVES  
 POWER BRUSHES  
 NYLOX BRUSHES  
 PACKAGED ITEMS  
 MAINTENANCE



# WHAT'S NEW?

## ABRASIVES



Page 14

### ULTRACUT 1MM THIN CUTTING WHEELS

Unmatched cutting performance and toughness with a TRUE 1 millimeter thickness. These wheels deliver precise, clean cuts with smaller seams on thin gauge and small diameter metals, reducing welding and finishing.



Page 15, 18 & 20

### CERAMIC CUTTING, GRINDING, AND COMBINATION WHEELS

Maximize your time on the job with a superior combination of life and cut rate for maximum productivity. Self-sharpening Ceramic grain removes material effortlessly while a hard bond keeps working longer.



Page 19

### TYPE 28 GRINDING WHEELS

The saucer-shaped design allows users to reach angles and corners with reduced interference, while maintaining aggressive grinding at lower angles. Type 28 wheels also provide a wider surface contact for grinding broader surfaces.



Page 28-29

### TIGER® ANGLED FLAP DISCS

An aggressive, long life solution for grinding fillet welds, T-joints and other hard-to-reach places. The 90° angled flap design forms perfectly into angles while the phenolic back provides stability to the flaps. This combination optimizes flap-to-metal contact, resulting in exceptional feel and control while grinding and finishing.



Page 31

### BOBCAT™ MINI FLAP DISCS

Our expanded line now offers a male "Type R" thread mount in addition to the current "Type S" mount. These discs are designed for use on right angle die grinders to provide smooth grinding and enhanced conformability in tight areas.



Page 34-35

### WOLVERINE™ FLAP DISCS

Designed to deliver fast material removal and consistent performance at a great value. Previously branded Vortec Pro® - Wolverine gets the job done for fabrication professionals, aggressively grinding and blending carbon and stainless steel in every-day applications.

## POWER BRUSHES



Page 68

### ROUGHNECK® MAX WHEELS

Our re-engineered Roughneck Max brushes deliver MAXimum impact and up to twice the life. Combine that with the hardest, strongest wire and an improved knot design to MAXimize cleaning power and you have a brush that you can trust when your name is on the line.



Page 69

### WOLVERINE™ WHEELS

Previously branded Vortec Pro® - these wheels offer professional grade quality and performance at a great value. These re-engineered 32 knot wheels deliver 20% MORE life while maintaining aggressive cleaning power for weld cleaning applications.

## NYLOX® BRUSHES

### MORE SIZE OPTIONS!



Page 119

### BURR-RX® TUBE BRUSHES

#### CRIMPED BLACK CERAMIC FILAMENT 1/4" CADMIUM PLATED STEMS

Ideal for internal deburring and finishing applications in tubular component parts, drilled and tapered holes, and machined bores and passages.



# HOW CAN WE HELP YOU?

## WEILERCORP.COM

Our website offers tools and educational materials to help you solve your toughest challenges:

- Locate a distributor in your area
- Electronic catalog
- Available literature
- Videos
- Technical papers
- SDS sheets
- Product information
- Product cross reference



## CONTACT US TODAY!

To place an order or locate a distributor in your area, contact our Customer Experience Team at 800-835-9999 or [orders@weilercorp.com](mailto:orders@weilercorp.com).

For custom products, our Application Engineering Department will work with you to design and manufacture the best product and recommend the best process for your specific requirements. Call 888-299-APPS (2777).



# SAFETY INFORMATION

All of Weiler's products are made to the strictest quality standards and specifications and are designed to provide superior work performance and safe operation when used properly.



**WARNING:** Failure to observe safety precautions may result in injury.

Many manufacturers mark some safety warnings, recommendations and usage restrictions directly on the product. However, it is not always practical to include even the most limited safety information on the product itself. Therefore, the operator **MUST READ** and **FOLLOW** all instructions supplied in or on the product container as well as those marked on the product.

## SAFETY STANDARDS - ESTABLISHED BY THE AMERICAN NATIONAL STANDARDS INSTITUTE

Weiler power brushes and abrasives conform to the ANSI standards listed below. All operators of power brushes and abrasives must comply with these safety standards.

- ANSI B165.1 "Power Tools - Power Driven Brushing Tools - Safety Requirements for Design, Care and Use"
- ANSI B7.1 "Safety Requirements - For the Use, Care and Protection of Abrasive Wheels"

## AVAILABILITY OF ANSI STANDARDS

Based on the collective experience of the American Brush Manufacturers Association Industrial Division members (ANSI B165.1) and the United Abrasives Manufacturers Association's Bonded Division (ANSI B7.1), both ANSI Standards are referenced and provided solely as a public service for the guidance of the users of the members' products. All Brush and Abrasive recommendations are not necessarily complete with respect to any particular application and common sense safety considerations should generally be followed. Any applicable federal, state, local law or regulation must be strictly adhered to and is controlling over any recommendation contained herein.

## TOOL/WORK REST

On bench grinders, tool/work rests should be used to support the work-piece during use. It should have a maximum opening of 1/8" to the product face. Only adjust the rest when the product is not in motion.

Weiler products are designed and manufactured to the strictest standards to ensure the highest level of quality and safety. But safety doesn't stop there; raising awareness of basic safety practices and thinking about safety before the job starts — and after the job is complete — can help curb accidents and injuries in the shop. That's why Weiler offers customers a Safety Training Program based on the SPOT (Speed & Size, Pressure, Orientation, Time ) methodology to help promote safe and proper product usage.



Deploying our **SPOT SAFETY TRAINING PROGRAM** in your facility helps improve safety, regardless of your application or work environment.



..... Safety Goggles / Face Shield



..... Protective Clothing



..... Hearing Protection



..... Safety Gloves



..... Respiratory Protection



..... Speed



..... Tool Guard



Dually® Stringer Bead Wheel

Tiger® Grinding Wheel

Tiger® X Flap Disc





## PERFORMANCE YOU EXPECT

Weiler's line of bonded abrasives deliver consistency and performance to Metal Fabrication professionals. This high quality line includes cutting, grinding and combination wheels that are available in performance tiers, offering a choice between long life, fast cut, or both.

Weiler raised the bar by adding two new products to it's bonded abrasives line. Tiger® ULTRACUT wheels deliver unmatched cutting performance with a TRUE 1 millimeter profile. Tiger Ceramic maximizes your time on the job with a superior combination of life and cut rate for maximum productivity.

<b>Technical Information</b> .....	10-13
<b>Cutting Wheels</b> .....	14-17
<b>Grinding Wheels</b> .....	18-19
<b>Cup Rocks</b> .....	19
<b>Combo Wheels</b> .....	20-21
<b>Pipeline Wheels</b> .....	21

# BONDED ABRASIVES



# UNCAGED AND READY TO ATTACK

Weiler's Cutting, Grinding and Combination wheels help Metal Fabrication professionals get the most demanding jobs done right, and done fast. Our high quality line helps you select the best solution for your toughest jobs. Whether you're looking for serious stock removal, beveling, grinding, notching, cutting or edge softening, Weiler will get it done for you.



## SUPERIOR LIFE & CUT MAX PERFORMANCE TIGER CERAMIC

Maximize your time on the job with a superior combination of life and cut rate for maximum productivity. Self-sharpening and cool cutting, Ceramic grain removes material effortlessly while a hard bond keeps working longer.

CUT RATE: ●●●●●●  
LIFE: ●●●●●●

## LONG LIFE & FAST CUT HIGH PERFORMANCE ZIRC / INOX / ROUGHNECK

High Performance Tiger wheels cut faster and last longer so you get proven productivity at an exceptional total cost. This line up is designed for hard core Metal Fabrication professionals who need the best solution for the toughest jobs.

CUT RATE: ●●●●●●  
LIFE: ●●●●●●

## LONG LIFE PERFORMANCE LINE TIGER

Weiler Tiger wheels deliver the right combination of performance and value. This versatile line up offers a long life solution for all your general purpose applications.

CUT RATE: ●●●●●●  
LIFE: ●●●●●●

## FAST CUT VALUE LINE WOLVERINE

Weiler Wolverine cutting and grinding wheels deliver a fast cut rate and consistent performance at a good value. Wolverine is an aggressive, get it done product line for every day general purpose use.

CUT RATE: ●●●●●●  
LIFE: ●●●●●●

All products meet ANSI B7.1-2010.

Key:

**P** PERFORMANCE LINE  
Industrial Grade

**V** VALUE LINE  
Professional Grade



# FEATURES & BENEFITS

	MAX PERFORMANCE	HIGH PERFORMANCE	PERFORMANCE	VALUE
<b>Cool cutting</b> Ceramic grains grind at lower temperatures and with less friction, reducing heat discoloration of the work piece.	✓			
<b>Thin and ultra thin wheels</b> deliver lightning fast, accurate, clean cuts.	✓	✓	✓	✓
<b>Smooth outer layer</b> on cutting wheels reduces friction which translates to an effortless cut and less kickback.	✓	✓	✓	
<b>Self-sharpening grain</b> retains high cutting performance throughout the life of the wheel.	✓	✓		
<b>Strong resin bond</b> delivers a long cutting life that keeps professionals productive.	✓	✓	✓	
<b>Ceramic Infusion</b> in select grinding & combo wheels delivers faster grinding with less effort.	✓	✓		
<b>Cut back</b> provides instant aggressive grinding on new wheels.	✓	✓	✓	
<b>Contaminant-free INOX</b> provides a worry free solution for stainless steel.	✓	✓		
<b>Roughneck Pipeline</b> wheels are specifically designed for demanding notching applications without removing excess material.		✓		
<b>Reinforcement rings</b> strengthen the arbor hole and provide a smooth mounting surface.	✓	✓	✓	✓
<b>Small hub</b> on 4-1/2" wheels increase cutting area by 30%.	✓	✓	✓	✓

# GRAIN / GRIT / GRADE

Selecting the best grain, grit and grade combination for your application can increase wheel effectiveness and user productivity. Use the charts below to help pick the right wheel for the job.

## Grain

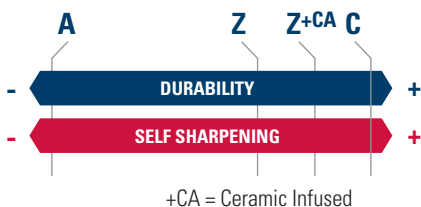

## Grit

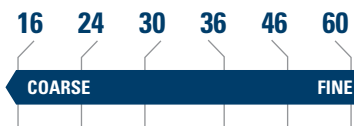

## Hardness









# THICKNESS





		T 1	T 27	T 28
<b>ULTRA THIN CUTTING</b>	.035	✓		
	1 MM	✓		
<b>THIN CUTTING</b>	.045	✓	✓	
	.060	✓	✓	
<b>CUTTING</b>	1/16	✓		
	3/32	✓	✓	
<b>PIPELINE &amp; COMBO</b>	1/8		✓	
	1/4		✓	✓











# SELECTION GUIDE

<b>PERFORMANCE</b>	<b>SUPERIOR LIFE &amp; CUT</b>	<b>LONG LIFE &amp; FAST CUT</b>		<b>LONG LIFE</b>	<b>FAST CUT</b>	
						
	<b>TIGER CERAMIC</b> Self-sharpening and cool cutting, Ceramic grain removes material effortlessly while a hard bond keeps working longer.	<b>TIGER ZIRC</b> Self-sharpening Zirconia grain retains high cutting performance through the life of the wheel.	<b>TIGER INOX</b> A contaminant-free bond that delivers a worry-free solution for stainless steel applications.	<b>ROUGHNECK</b> Ceramic infused wheels designed for tough applications on the pipeline.	<b>TIGER</b> Aluminum Oxide grains and a strong resin bond delivers a long cutting life that keeps professionals on the job longer.	<b>WOLVERINE</b> Weiler Wolverine cutting and grinding wheels deliver a fast cut rate and consistent performance at a great value.
	<b>MATERIAL</b>	Tool Steel, Inconel, High Nickel Alloy, Titanium, and Armored Steel	Carbon Steel, Structural Steel, and Cast Iron	Stainless Steel, and harder Steel grades	Pipeline	Carbon Steel, Cast Iron, and general purpose metal use

<b>SIZE</b>	2"	3"	4"	4.5"	5"	6"	7"	9"	12"	14"
	<b>DIE GRINDERS</b> 1/4" & 3/8" Arbor		<b>GRINDERS</b> 5/8" Arbor	<b>ANGLE GRINDERS</b> 7/8" Arbor or 5/8"-11 Nut					<b>SAWS</b> 1" Arbor	

<b>TYPE</b>	<b>CUTTING</b>				<b>GRINDING</b>		
	<b>Type 1</b> (Flat)	<b>Type 27</b> (Depressed Center)	<b>Type 27</b> (Depressed Center)	<b>Type 28</b> (Depressed Center)	<b>Type 11</b> (Cup Rock)		
							
	Flat profile allows for deep cuts	Added clearance when working at a constrained angle	Flat profile with depressed center allows for a wide range of grinding angles (0-45)	Designed for increased aggression at lower working angles and increased access	Excellent for snagging and rough stock removal applications		

When selecting a wheel, always choose the thinnest wheel that will perform the cut while maintaining desired product life.

<b>ULTRA THIN WHEEL</b> 1MM	<b>THIN WHEEL</b> .045"	<b>THIN WHEEL</b> .060"	<b>CUTTING WHEEL</b> 3/32"	<b>CUTTING WHEEL</b> 1/8"	<b>COMBO WHEEL</b> 1/8"	<b>PIPELINE WHEEL</b> 1/8"	<b>GRINDING WHEEL</b> 1/4"
							
Sheet metal, tubes, profiles and small cross-section rods	Tubes, bar stock and large cross-sections	Angle Iron, large cross-sections	Notching	Switching between cutting and grinding	pipeline root pass notching & facing	Heavy stock removal, scale removal, weld removal, weld blending, edge beveling and torch-cut softening	





## REDUCING VIBRATION

Excessive vibration binds the wheel and makes it difficult to control through the cut.

Check the mounting/clamping point. Ensure that the work piece is clamped securely and as close as possible to the mounting point or vice to allow safe and adequate clearance of the tool, guard and hands.



## PUSH VERSUS PULL

Weiler's Tiger grinding wheels are instantly aggressive out of the box. When possible, it is most effective to begin grinding on the pull stroke. This will minimize the risk of undercutting or gouging.

It is common to use more pressure through the push stroke and less pressure during the pull stroke. The most efficient grinding technique requires consistent pressure in both directions. Do not use excessive pressure in either direction and allow the grains do the work. Overpowering a grinding disc will NOT increase cut rate and WILL break down at a faster rate, reducing disc life.



## CUTTING ANGLE IRON OR SQUARE TUBING

When clamping angle iron on a table or bench, it is important to fix the piece with the corner perpendicular to the table. When clamping in a vise, the preferred approach is from the corner.

When cutting material with larger surface area like square tubing or angle iron, beginning the cut from a corner reduces friction and will minimize kick-back. After allowing the tool to reach full speed, engage the piece from the corner and work the wheel through the material using consistent pressure. Use light to moderate pressure to work through the cut being careful not to plunge the wheel too deeply into the tube. Depth of cut will depend on wall thickness.



## ROUND BAR AND ROUND TUBE

Cutting round bar stock or tubing, is easier since the countered surface provides the same contact surface regardless of angle. Applying light to moderate pressure and consistent movement will provide the most efficient cut and minimize heat build-up.



## HEAT DISCOLORATION

Heat is the enemy of any abrasive. To minimize discoloration, use a smooth, consistent rocking motion through the cut.

Approach from the corner and use light pressure and a consistent motion through the cut for the fastest cut-rate and prolonged wheel life. Applying too much pressure through the cut causes increased friction and heat build-up. This can cause increased heat discoloration of the work piece and reduced wheel life.

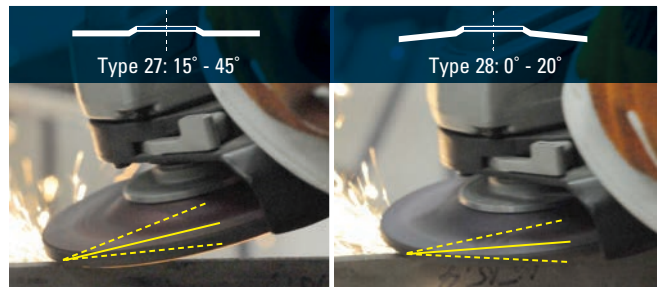

## GRINDING ANGLES

The optimal grinding angle for a 1/4" Type 27 grinding wheel is between 15 and 30 degrees. Generally speaking, the steeper the grinding angle, the more aggressive the cut. Grinding at lower angles can prolong life, but will compromise cut rate. When grinding shallow on harder materials, chatter and vibration can become a factor.

When lower grinding angles are required, consider a Type 28 grinding wheel. Its unique saucer profile provides increased aggression at lower grinding angles while also allowing access in tighter areas, such as corners, fillets, and overhangs.

# CUTTING WHEELS



Cutting a v-groove in bar stock with a Tiger Cutting Wheel.

Weiler's diverse line of cutting wheels provide a consistent, well balanced, high quality solution. From our thin cutting wheels that slice through metal, to our large diameter wheels for the biggest cuts, professionals get the most demanding jobs done right and done fast.

## FEATURES:

- **Ultracut 1MM cutting wheels** deliver lightning fast, super smooth, clean cuts.
- **Thin cutting** wheels deliver accurate, clean cuts.
- **Dual reinforcement** provides added strength for aggressive cutting.
- **Contaminant-free INOX** wheels provide a worry free solution for stainless steel applications.
- **Smooth outer layer** on performance cutting wheels reduces friction that translates to an effortless cut and less kickback during operation.

## TYPE 1 FOR GRINDERS



58006

**NEW!**

**P**

### TIGER ZIRC ULTRACUT 1MM THIN CUTTING WHEELS / Fast Cut & Long Life on Metal

Self-sharpening Zirconia Alumina grain that retains a high cut rate throughout the life of the wheel so you get exceptional performance on thin gauge and small diameter steel and stainless steel applications.



Diameter	Thickness	Grade	Max. RPM	TYPE 1 7/8" Arbor	
				Std. Pack	Item #
4-1/2"	1 MM	Z60T	13,300	50	58005
5"	1 MM	Z60T	12,200	50	58006



58131

**NEW!**

**P**

### TIGER INOX ULTRACUT 1MM THIN CUTTING WHEELS / Contaminant-Free\* for Stainless

INOX wheels are specifically designed for high performance on thin gauge and small diameter STAINLESS STEEL. These wheels incorporate a Contaminant-free bond that delivers a worry free solution for stainless steel applications.



Diameter	Thickness	Grade	Max. RPM	TYPE 1 7/8" Arbor	
				Std. Pack	Item #
4-1/2"	1 MM	INOX60T	13,300	50	58130
5"	1 MM	INOX60T	12,200	50	58131

\*Contaminant-Free, Contains ≤ .1% Fe, S, Cl

CUTS  
**20%**  
FASTER  
than the closest  
competitor

PROPRIETARY  
**SOLID**  
**CORE**  
TECHNOLOGY

increases wheel density,  
resulting in longer life,  
reduced friction, &  
superior stability

A TRUE  
**1MM**  
THICKNESS

delivers precise, consistent  
cuts you can count on

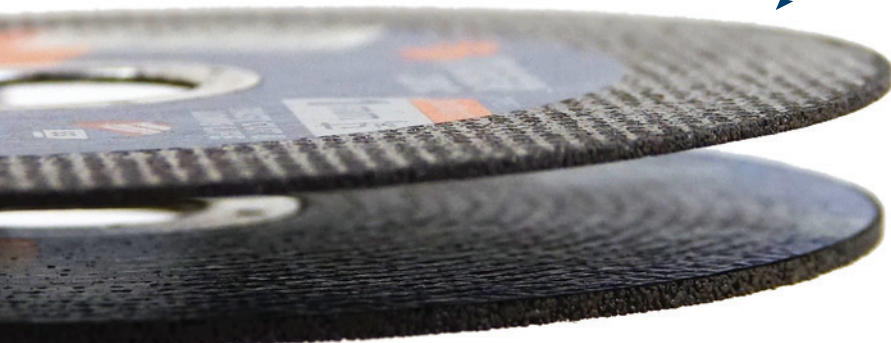

TRUE  
1 MILLIMETER

STANDARD  
.045"



# TYPE 1 & 27 FOR GRINDERS

NEW!

**P TIGER CERAMIC CUTTING WHEELS / Ceramic Alumina / Superior Life & Cut on Metal**  
Self-sharpening Ceramic Alumina grain delivers a superior combination of life and cut rate. Ideal for stainless steel and other hard-to-cut metals.



Diameter	Thickness	Grade	Max. RPM	TYPE 1 7/8" Arbor		TYPE 27 7/8" Arbor		TYPE 27 5/8"-11 Hub	
				Std. Pack	Item#	Std. Pack	Item #	Std. Pack	Item #
4-1/2"	.045"	CER60S	13,300	25	58300	25	58305	10	58306
5"	.045"	CER60S	12,200	25	58301	25	58307	10	58308
6"	.045"	CER60S	10,200	25	58302	25	58309	10	58310
7"	.060"	CER60S	8,500	25	58303	25	58311	10	58312

\*Contaminant-Free, Contains ≤ .1% Fe, S, Cl



58302



58306

**P TIGER ZIRC CUTTING WHEELS / Zirconia Alumina / Fast Cut & Long Life on Metal**  
High performance wheels leverage a self-sharpening Zirconia Alumina grain that retains a high cut rate throughout the life of the wheel so you get maximum productivity on steel and stainless steel.



Diameter	Thickness	Grade	Max. RPM	TYPE 1 7/8" Arbor		TYPE 27 7/8" Arbor	
				Std. Pack	Item#	Std. Pack	Item #
4-1/2"	.045"	Z60T	13,300	25	58000	25	58020
5"	.045"	Z60T	12,200	25	58001	25	58021
6"	.045"	Z60T	10,200	25	58002	25	58022
7"	.060"	Z60T	8,500	25	58003	25	58023



58000

**P TIGER INOX CUTTING WHEELS / White Aluminum Oxide / Contaminant-Free\* for Stainless**  
INOX wheels are specifically designed for high performance on STAINLESS STEEL. These wheels incorporate a Contaminant-free bond that delivers a worry free solution for stainless steel applications.



Diameter	Thickness	Grade	Max. RPM	TYPE 1 7/8" Arbor		TYPE 27 7/8" Arbor		TYPE 27 5/8"-11 Hub	
				Std. Pack	Item#	Std. Pack	Item #	Std. Pack	Item #
4-1/2"	.045"	INOX60S	13,300	25	58100	25	58110	10	58109
5"	.045"	INOX60S	12,200	25	58101	25	58111	—	—
6"	.045"	INOX60S	10,200	25	58102	25	58112	10	58113
7"	.060"	INOX60S	8,500	25	58103	25	58107	—	—

\*Contaminant-Free, Contains ≤ .1% Fe, S, Cl



58112

**P TIGER CUTTING WHEELS / Premium Aluminum Oxide / Long Life on Metal**  
Premium Aluminum Oxide grains provide an even, sharp, clean cut and a hard bond extends life and maximizes performance.



Diameter	Thickness	Grade	Max. RPM	TYPE 1 7/8" Arbor		TYPE 27 7/8" Arbor		TYPE 27 5/8"-11 Hub	
				Std. Pack	Item #	Std. Pack	Item #	Std. Pack	Item #
4-1/2"	.045"	A60T	13,300	25	57020	25	57041	10	57040
	1/16"	A36T		25	57061	—	—	—	—
	3/32"	A36S		—	—	25	57081	10	57080
5"	.045"	A60T	12,200	25	57021	25	57043	10	57042
	3/32"	A36S		—	—	25	57083	10	57082
6"	.045"	A60T	10,200	25	57022	25	57045	10	57044
7"	.060"	A60T	8,500	25	57023	25	57046	—	—
9"	1/16"	A60T	6,600	—	—	25	57047	—	—



57022



57080

WHY WEILER

BONDED ABRASIVES

COATED ABRASIVES

NON-WOVEN ABRASIVES

POWER BRUSHES

NYLON BRUSHES

PACKAGED ITEMS

MAINTENANCE

# TYPE 1 FOR GRINDERS

## V WOLVERINE CUTTING WHEELS / Aluminum Oxide / Fast Cutting on Metal

Fast cut rate and consistent performance at a good value for everyday, general purpose use on metal.



56385



56476

Dia.	Thick	Grade	Max. RPM	TYPE 1 7/8" Arbor		TYPE 27 7/8" Arbor		TYPE 27 5/8"-11 Hub	
				Std. Pack	Item #	Std. Pack	Item #	Std. Pack	Item #
4-1/2"	.045"	A60T	13,300	50	56281	—	—	—	—
	.045"	A60S		—	—	25	56393	—	—
	1/16"	A60T		50	56103	—	—	—	—
	3/32"	A24T		—	—	25	56475	10	56385
5"	.045"	A60S	12,200	—	—	100	56392	—	—
	1/16"	A36T		100	56118	—	—	—	—
	3/32"	A24T		—	—	25	56476	10	56384
6"	.040"	A60T	10,200	25	56282	—	—	—	—
	.045"	A60T		25	56273	—	—	—	—
	.045"	A60S		—	—	25	56283	—	—
	3/32"	A24R		—	—	25	56277	10	56278
7"	.045"	A60T	8,500	25	56275	—	—	—	—
	.060"	A60S		—	—	25	56391	—	—
	3/32"	A24R		—	—	25	56383	10	56477
9"	1/8"	A24T	6,600	—	—	—	—	10	56423

# TYPE 1 FOR DIE GRINDERS

## P TIGER CUTTING WHEELS / Premium Aluminum Oxide / Long Life on Metal

Premium Aluminum Oxide grains provide an even, sharp, clean cut and a hard bond extends life and maximizes performance.



57001

Diameter	Thickness	Grade	Max. RPM	TYPE 1 3/8" Arbor	
				Std. Pack	Item#
3"	.035"	A60T	25,000	100	57001 ◆
	1/16"	A36T		—	57060

◆ Super Thin Wheel

## V WOLVERINE CUTTING WHEELS / Aluminum Oxide / Fast Cutting on Metal

Fast cut rate and consistent performance at a good value for everyday, general purpose use on metal.



56013



56062

Diameter	Thickness	Grade	Max. RPM	TYPE 1 1/4" Arbor		TYPE 1 3/8" Arbor		TYPE 1 5/8" Arbor	
				Std. Pack	Item#	Std. Pack	Item #	Std. Pack	Item #
2"	.035"	A60T	30,000	100	56013 ◆	—	—	—	—
	1/16"	A36T		50	56015	—	—	—	—
3"	.035"	A60T	25,000	100	56061 ◆	100	56062 ◆	—	—
	1/16"	A36T		100	56065	100	56068	—	—
	1/16"	A60T		—	—	100	56070	—	—
	1/8"	A36T		50	56076	—	—	—	—
4"	.035"	A60T	19,000	—	—	50	56080 ◆	50	56271 ◆
	3/32"	A24T		—	—	—	—	25	56474
	1/16"	A36T	15,200	—	—	50	56086	—	—
	1/8"	A36T		—	—	50	56099	—	—
5"	.035"	A60T	12,200	—	—	—	—	100	56108 ◆

◆ Super Thin Wheel



*"Cuts fast and it really holds up."*

- Louis V., Pipe Fabricator, Texas

WHY WEILER

BONDED ABRASIVES

COATED ABRASIVES

NON-WOVEN ABRASIVES

POWER BRUSHES

NYLON BRUSHES

PACKAGED ITEMS

MAINTENANCE

## TYPE 1 FOR CHOP SAWS / STATIONARY SAWS

**P** **TIGER LARGE CUTTING** / Aluminum Oxide / Long Life on Metal  
Premium Aluminum Oxide grains provide an even, sharp, clean cut and a hard bond extends life and maximizes performance.



Diameter	Thickness	Grade	Max. RPM	TYPE 1 1" Arbor	
				Std. Pack	Item#
12"	3/32"	A36T	5,100	25	57090
14"	1/8"	A30R	4,400	10	57091*
	3/32"	A36T			57092
		A36R			57093 ◆



57090

\*Recommended for Stationary Saws only. ◆ Softer bond for smoother, faster cutting.

**V** **WOLVERINE LARGE CUTTING** / Aluminum Oxide / Fast Cutting on Metal  
Fast cut rate and consistent performance at a good value for everyday, general purpose use on metal.



Diameter	Thickness	Grade	Max. RPM	TYPE 1 1" Arbor	
				Std. Pack	Item#
<b>For Chop Saws</b>					
12"	3/32"	A46T	5,100	25	56239
14"	3/32"	A46T	4,400	10	56240
<b>For Stationary Saws</b>					
14"	1/8"	A30R	4,400	10	56230



56239

## ACCESSORIES

**ADAPTING NUTS & SPANNER WRENCH** For 4-1/2" - 9" Angle Grinders.

Description	Adapts To	Min. Wheel Thickness	Standard Pack	Item Number
Adapting Nuts	7/8" to 5/8"-11	1/16"	1	56494
Spanner Wrench	-	-	1	56495
Adapting Nuts	5/8" to 3/8"-24	1/16"	1	56484



56494

56495

**MOUNTING MANDRELS** 1/4" Stem. For Type 1 Wheels Only.

Arbor Size	Wheel Thickness	Standard Pack	Item Number
1/4"	.035" to 1/4"	10	56489
3/8"	.035" to 1/4"	10	56490
1/4", 3/8" *	.035" to 1/4"	10	56491*
1/4", 3/8"	.035" to 1/4"	1	36512



56489

\*Combination pack

# GRINDING WHEELS



Grinding on a platform for weld preparation.

Weiler's high quality line of grinding wheels help Metal Fabrication professionals get the most demanding jobs done right and done fast.

## FEATURES:

- **Ceramic Infused** grinding wheels deliver the fastest cutting with the least effort.
- **Triple Fiberglass Reinforcement** provides added strength for aggressive stock removal.
- Type 27 Grinding Wheels are designed with fiberglass **cut back** from the edge to provide instant aggressive grinding on new wheels.

## TYPE 27 FOR GRINDERS

**NEW!**

**P**

**TIGER CERAMIC GRINDING WHEELS** / Ceramic Alumina / Superior Life & Cut on Metal  
Self-sharpening Ceramic Alumina grain delivers a superior combination of life and cut rate. Ideal for stainless steel and other hard-to-grind metals.



58330

Diameter	Thickness	Grade	Max. RPM	TYPE 27 7/8" Arbor		TYPE 27 5/8"-11 Hub	
				Std. Pack	Item#	Std. Pack	Item #
4-1/2"	1/4"	CER24R	13,300	10	58325	10	58326
5"	1/4"	CER24R	12,200	10	58327	10	58328
6"	1/4"	CER24R	10,200	10	58329	10	58330
7"	1/4"	CER24R	8,500	10	58331	10	58332
9"	1/4"	CER24R	6,600	10	58333	10	58334

\*Contaminant-Free, Contains ≤ .1% Fe, S, Cl

**P**

**TIGER ZIRC GRINDING WHEELS** / Zirconia Alumina / Ceramic Infused for Faster, Longer Grinding  
High performance wheels leverage a self-sharpening Zirconia Alumina grain that delivers fast, consistent grinding on steel and stainless. All wheels are Ceramic Infused for that extra surge in performance.



58073

Diameter	Thickness	Grade	Max. RPM	TYPE 27 7/8" Arbor		TYPE 27 5/8"-11 Hub	
				Std. Pack	Item#	Std. Pack	Item #
4-1/2"	1/4"	Z24T	13,300	10	58071	10	58070
5"	1/4"	Z24T	12,200	10	58073	10	58072
6"	1/4"	Z24T	10,200	10	58079	10	58078
7"	1/4"	Z24T	8,500	10	58075	10	58074
9"	1/4"	Z24T	6,600	10	58077	10	58076

**P**

**TIGER INOX GRINDING WHEELS** / White Aluminum Oxide / Contaminant-Free\* for Stainless Steel  
INOX wheels are specifically designed for high performance on STAINLESS STEEL. These wheels incorporate a Contaminant-free bond that delivers a worry free solution for stainless steel applications.

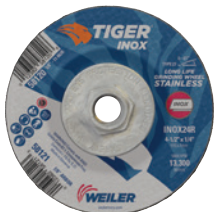

58120

Diameter	Thickness	Grade	Max. RPM	TYPE 27 7/8" Arbor		TYPE 27 5/8"-11 Hub	
				Std. Pack	Item#	Std. Pack	Item #
4-1/2"	1/4"	INOX24R	13,300	10	58121	10	58120
5"	1/4"	INOX24R	12,200	10	58123	10	58122
7"	1/4"	INOX24R	8,500	10	58125	10	58124
9"	1/4"	INOX24R	6,600	10	58127	10	58126

\*Contaminant-Free, Contains ≤ .1% Fe, S, Cl

**P**

**TIGER GRINDING WHEELS** / Premium Aluminum Oxide / Long Grinding Life on Metal  
Weiler Tiger grinding wheels deliver the right combination of performance and value. Premium Aluminum Oxide grains provide an even, sharp, clean cut and a hard bond extends life and maximizes performance.



57120

Diameter	Thickness	Grade	Max. RPM	TYPE 27 7/8" Arbor		TYPE 27 5/8"-11 Hub	
				Std. Pack	Item#	Std. Pack	Item #
4-1/2"	1/4"	A24R	13,300	10	57121	10	57120
5"	1/4"	A24R	12,200	10	57123	10	57122
6"	1/4"	A24R	10,200	10	57129	10	57128
7"	1/4"	A24R	8,500	10	57125	10	57124
9"	1/4"	A24R	6,600	10	57127	10	57126



**V** **WOLVERINE GRINDING WHEELS** / Aluminum Oxide / Fast Grinding on Metal 0-45°

Fast grinding and consistent performance at a good value for everyday, general purpose use on metal.

Diameter	Thickness	Grade	Max. RPM	TYPE 27 5/8" Arbor		TYPE 27 7/8" Arbor		TYPE 27 5/8"-11 Hub	
				Std. Pack	Item#	Std. Pack	Item #	Std. Pack	Item #
4"	1/4"	A24R	15,200	25	56473	—	—	—	—
4-1/2"	1/4"	A24R	13,300	—	—	25	56464	10	56454
4-1/2"	1/4"	A24N	13,300	—	—	25	56457	10	56455
5"	1/4"	A24R	12,200	—	—	25	56466	10	56449
6"	1/4"	A24R	10,200	—	—	25	56280	10	56279
7"	1/4"	A24R	8,500	—	—	25	56467	10	56468
9"	1/4"	A24R	6,600	—	—	—	—	10	56470



56279

**TYPE 28  
FOR GRINDERS**

**NEW!**

**P** **TIGER ZIRC GRINDING WHEELS** / Zirconia Alumina / Ceramic Infused for Faster, Longer Grinding 0-45°

High performance wheels allow for aggressive grinding at lower angles with reduced interference. All wheels leverage a self-sharpening Zirconia Alumina grain and are Ceramic Infused for that extra surge in performance.

Diameter	Thickness	Grade	Max. RPM	TYPE 28 7/8" Arbor		TYPE 28 5/8"-11 Hub	
				Std. Pack	Item#	Std. Pack	Item #
7"	1/4"	Z24T	8,500	10	58081	10	58080
9"	1/4"	Z24T	6,600	10	58083	10	58082



58081

**NEW!**

**P** **TIGER GRINDING WHEELS** / Premium Aluminum Oxide / Long Grinding Life on Metal 0-45°

Tiger grinding wheels allow for aggressive grinding at lower angles with reduced interference. Premium Aluminum Oxide grains provide an even, sharp, clean cut and a hard bond extends life and maximizes performance.

Diameter	Thickness	Grade	Max. RPM	TYPE 28 7/8" Arbor		TYPE 28 5/8"-11 Hub	
				Std. Pack	Item#	Std. Pack	Item #
7"	1/4"	A24R	8,500	10	57135	10	57134
9"	1/4"	A24R	6,600	10	57137	10	57136



57134

**TYPE 11  
CUP ROCKS**

**P** **TIGER CUP ROCKS** / Premium Aluminum Oxide / Steel Back 0-15°

Premium Aluminum Oxide grains provide an even, sharp, clean cut and a hard bond extends life and maximizes performance. Steel back provides superior support.

Diameter	Thickness	Grade	Max. RPM	TYPE 11 5/8"-11 Arbor	
				Std. Pack	Item#
4"	2"	A16R	9,000	10	57401
6"	2"	A16R	6,000	10	57403



57403

**TYPE 1  
FOR GRINDERS**

**V** **WOLVERINE SNAGGING WHEELS** / Aluminum Oxide / Fast Grinding on Metal 90°

Fast cut rate and consistent performance at a good value for everyday, general purpose use on metal.

Diameter	Thickness	Grade	Max. RPM	TYPE 1 3/8" Arbor	
				Std. Pack	Item#
2"	1/4"	A60T	30,000	25	56131
4"	1/4"	A36T	19,000	25	56163



56163

WHY WEILER  
BONDED ABRASIVES  
COATED ABRASIVES  
NON-WOVEN ABRASIVES  
POWER BRUSHES  
NYLON BRUSHES  
PACKAGED ITEMS  
MAINTENANCE

# COMBO WHEELS



Weld removal with Tiger combo wheel.

Weiler's Combination Wheels offer flexibility and efficiency when switching between cutting and grinding applications. **A third layer of fiberglass reinforcement** provides the strength to hold up when grinding, while the type of fiberglass used maintains a fast cut.

## TYPE 27 FOR GRINDERS

**NEW!**

**P**

### TIGER CERAMIC COMBO WHEELS / Ceramic Alumina / Superior Life & Cut on Metal

Self-sharpening Ceramic Alumina grain delivers a superior combination of life and cut rate. Ideal for stainless steel and other hard-to-cut metals.

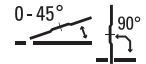

58315

Diameter	Thickness	Grade	Max. RPM	TYPE 27 7/8" Arbor		TYPE 27 5/8"-11 Hub	
				Std. Pack	Item#	Std. Pack	Item #
4-1/2"	1/8"	CER30T	13,300	25	58315	10	58316
5"	1/8"	CER30T	12,200	25	58317	10	58318
6"	1/8"	CER30T	10,200	25	58319	10	58320
7"	1/8"	CER30T	8,500	25	58321	10	58322
9"	1/8"	CER30T	6,600	25	58323	10	58324

\*Contaminant-Free, Contains ≤ .1% Fe, S, Cl

**P**

### TIGER ZIRC COMBO WHEELS / Zirconia Alumina / Fast & Long Life Combo on Metal

High performance cut & grind combo wheels deliver a high grind rate AND extended life. Harder, sharper, faster cutting grains provide a fast, consistent performance on steel and stainless steel.

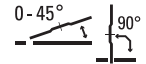

58054

Diameter	Thickness	Grade	Max. RPM	TYPE 27 7/8" Arbor		TYPE 27 5/8"-11 Hub	
				Std. Pack	Item#	Std. Pack	Item #
4-1/2"	1/8"	Z30T	13,300	25	58051	10	58050
5"	1/8"	Z30T	12,200	25	58053	10	58052
6"	1/8"	Z30T	10,200	25	58064	10	58054
7"	1/8"	Z30T	8,500	25	58056	10	58055
9"	1/8"	Z30T	6,600	25	58058	10	58057

**P**

### TIGER INOX COMBO WHEELS / White Aluminum Oxide / Contaminant-Free\* for Stainless Steel

Long life cut & grind combo wheels deliver true flexibility and efficiency when switching between cutting and grinding for stainless steel applications.

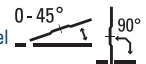

58114

Diameter	Thickness	Grade	Max. RPM	TYPE 27 7/8" Arbor		TYPE 27 5/8"-11 Hub	
				Std. Pack	Item#	Std. Pack	Item #
4-1/2"	1/8"	INOX30T	13,300	25	58115	10	58114
7"	1/8"	INOX30T	8,500	25	58117	10	58116
9"	1/8"	INOX30T	6,600	25	58119	10	58118

\*Contaminant-Free, Contains ≤ .1% Fe, S, Cl

**P**

### TIGER COMBO WHEELS / Premium Aluminum Oxide / Long Life Combo on Metal

Cut & grind combo wheels deliver true flexibility and efficiency when switching between cutting and grinding.

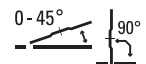

57102

Diameter	Thickness	Grade	Max. RPM	TYPE 27 7/8" Arbor		TYPE 27 5/8"-11 Hub	
				Std. Pack	Item#	Std. Pack	Item #
4-1/2"	1/8"	A30S	13,300	25	57101	10	57100
5"	1/8"	A30S	12,200	25	57103	10	57102
6"	1/8"	A30S	10,200	25	57109	10	57108
7"	1/8"	A30S	8,500	25	57105	10	57104
9"	1/8"	A30S	6,600	25	57107	10	57106



**V WOLVERINE COMBO WHEELS / Aluminum Oxide / Fast Cut & Grind Combo on Metal**

Fast cut rate and consistent performance at a good value for everyday, general purpose use when switching between cutting and grinding on metals.

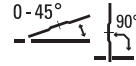

Diameter	Thickness	Grade	Max. RPM	TYPE 27 7/8" Arbor		TYPE 27 5/8"-11 Hub	
				Std. Pack	Item#	Std. Pack	Item #
4-1/2"	1/8"	A24T	13,300	25	56430	10	56429
5"	1/8"	A24T	12,200	25	56428	10	56427
7"	1/8"	A24T	8,500	25	56426	10	56425



56429

**TYPE 27 FOR PIPELINE**

**P ROUGHNECK PIPELINER WHEELS / Zirconia Alumina / Fast Grinding & Long Life**

Ceramic Infused Roughneck wheels are designed for tough root pass notching and facing applications by combining an 1/8" width for optimized material removal with the right hardness and grain mixture for high demand use on the pipeline.

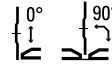

Diameter	Thickness	Grade	Max. RPM	TYPE 27 5/8"-11 Arbor	
				Std. Pack	Item#
4-1/2"	1/8"	Z30T	13,300	10	58059
6"	1/8"	Z30T	10,200	10	58060
7"	1/8"	Z30T	8,500	10	58061
9"	1/8"	Z30T	6,600	10	58062



58062

**NEW! P ROUGHNECK COMBO WHEELS / Zirconia Alumina / Fast Grinding & Long Life**

Ceramic Infused Roughneck combo wheels are thicker than pipeliner and designed to switch between cutting and grinding applications on the pipeline.

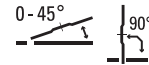

Diameter	Thickness	Grade	Max. RPM	TYPE 27 5/8"-11 Arbor	
				Std. Pack	Item#
7"	1/8"	Z30T	8,500	10	58065
9"	1/8"	Z30T	6,600	10	58063



58065

*Pipeline workers have trusted Weiler's Roughneck Stringer Bead brushes and aluminum backed Tiger Flap Discs for decades. With Tiger Roughneck, Weiler delivers the performance trifecta for pipeline contractors to get the job done right and done fast.*



WHY WEILER

BONDED ABRASIVES

COATED ABRASIVES

NON-WOVEN ABRASIVES

POWER BRUSHES









# COATED ABRASIVES

## WEILER WAS FIRST

From the company that brought flap discs to the US, Weiler coated abrasive products continue to set the standard. Our Premium Tiger® flap discs are engineered to conquer any material or application.

Weiler recently added several new flap discs to its coated abrasives line. Tiger X flap discs leverage industry-first technology to grind faster AND last longer. Tiger Angled delivers an aggressive, long life solution for grinding fillet welds, T-joints and other hard-to-reach places. Wolverine™ flap discs deliver fast material removal and consistent performance at a great value.

Technical Information .....	24-27
Abrasive Flap Discs .....	28-39
Resin Fiber Discs .....	40-41
AL-tra CUT™ Discs .....	41
Blending Discs .....	42
Trim-Kut® Discs .....	43
Flap Wheels .....	44-45
Shop Rolls .....	46



# SOLUTIONS SHOWCASE

## STEEL PIPING

**Problem:** A clean bevel end free of any surface imperfections is critical to a strong joint when welding heavy-wall piping. Unfortunately, lengths of steel pipe can sit in yards for significant periods of time, and pitting of the bevel ends is usually the result.

**Solution:** Coated abrasive flap discs like Weiler's original Tiger Disc are ideal tools for quickly removing heavy corrosion and blending pitting from bevel ends. The chatter-free, compliant grinding action and smooth, consistent finish produced by these discs make them the preferred choice for this application.



## STEEL CHANNEL

**Problem:** Burrs produced by cut-off operations are dangerous and can prevent parts from fitting together properly, which can cause potential structural weak points.

**Solution:** Weiler's coated abrasive flap wheels are flexible grinding products that are ideal for light stock removal applications. A 60 grit wheel can be used to remove a large burr and produce a smooth blended edge.

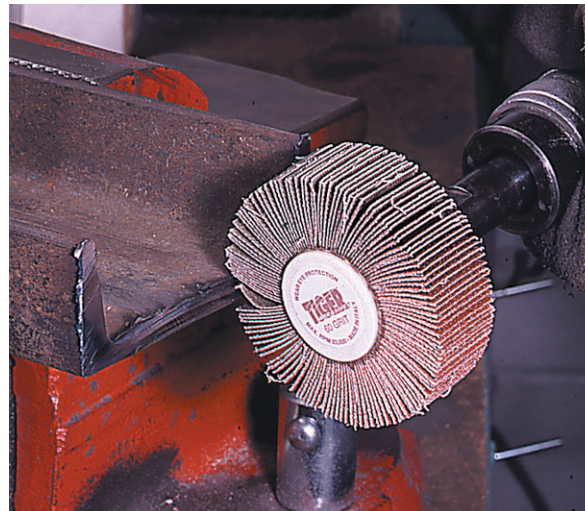

## ALUMINUM FRAMES

**Problem:** Aluminum welds are particularly difficult to blend due to the tendency of the chips to become welded to the abrasive media. This causes the cut rate of the abrasive to fall rapidly and generates an expensive grinding operation.

**Solution:** Weiler's AL-tra Cut™ discs are specially formulated to prevent loading by lowering the grinding temperature. A 60 grit AL-tra Cut disc can blend an aluminum weld bead much faster than a conventional disc without loading.

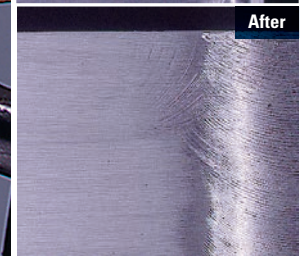
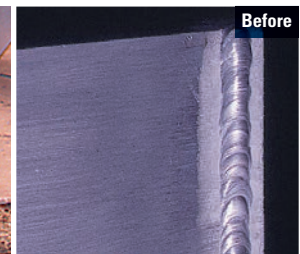





Before



After



## STRUCTURAL STEEL BEAM

**Problem:** Grinding fillet welds is a difficult, time-consuming process that is often expensive to perform.

**Solution:** Tiger Angled flap discs are a great option for the metalworking professional looking for more versatility than a traditional flap disc can offer and ready to go to work right out of the box. They are ideal for applications that previously required either a carbide burr or trimmable flap disc in order to access welds. Tiger Angled also provides versatility in repair and re-work applications, where it is important to focus grinding in a small area while minimizing impact to the surrounding work piece(s).

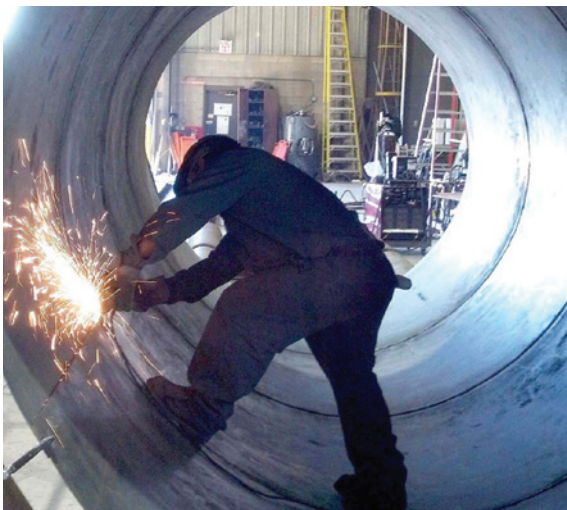

Before



After



## TANK AND PRESSURE VESSEL

**Problem:** The welds inside tanks and pressure vessels must be blended smooth prior to x-ray and pressure testing.

**Solution:** Weiler's Big Cat® High Density flap discs have the largest flap area in the industry – 22% more cloth. The result is enhanced conformability on curved or irregular surfaces and up to 40% longer life.



Before



After

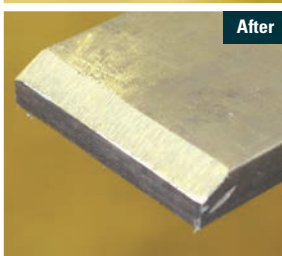

## STEEL RACK BRACES

**Problem:** To prevent weldments used in the construction of offshore oil platforms from "racking" under load, lengths of steel bar stock are added as braces during the fabrication of these structural members. Beveling or chamfering the ends of the bars increases weld penetration and strengthens the joint.

**Solution:** The requirement for fast stock removal and long wheel life makes this an ideal application for a good quality Type 27 grinding wheel like those in Weiler's Vortec Pro® line of general-purpose bonded abrasives.

# SELECTING THE RIGHT FLAP DISC

Weiler's Coated Abrasive flap discs grind and finish in one step, saving you time and money. There's no switching from a Type 27 Grinding Wheel to a Resin Fiber Disc. Use the information provided to help select the right solution for your application.



## P PERFORMANCE LINE (INDUSTRIAL GRADE)

Engineered and manufactured to maximize performance and minimize operating costs in the most demanding surface conditioning applications. The use of superior construction, the highest quality materials and the most stringent manufacturing processes deliver the lowest cost-of-use and most consistent performance in heavy production environments.

## V VALUE LINE (PROFESSIONAL GRADE)

Weiler Wolverine flap discs are designed to deliver fast material removal and consistent performance at a great value. Previous Vortec Pro®, Wolverine gets the job done for fabrication professionals, aggressively grinding and blending carbon and stainless steel in every-day applications.

ALL PERFORMANCE LINE PRODUCTS  
CONTAIN ≤ 0.1% IRON, SULPHUR & CHLORINE

CONTAMINANT  
**FREE**



		SABER TOOTH (CA)	BIG CAT (ZA)	TIGER X (ZA & CA)	TIGER AL BACK (ZA)	TRIMMABLE (ZA)	ANGLED (CA)	ANGLED (ZA)	BOBCAT (ZA)	TIGER PAW (ZA)	WOLVERINE (ZA)
APPLICATION	Flat Surface Grinding	★★★★		★★★★							★★
	Light Pressure / Blending	★★★★	★★★★ HD	★★★★		★★★★	★★	★★	★★	★★	★
	Weld Grinding / Blending	★★★★	★★★★ HD	★★★★		★★	★★	★★		★★★★	★
	Heavy Stock Removal	★★★★		★★						★★★★	★
	Edge Grinding	★★								★★★★	
	Pipeline				★★★★						
	Fillet Grinding	★★ TRIM					★★	★★★★	★★★★		
	Irregular Surface	★★★★ HD	★★★★ HD							★★ HD	★ HD
	Hard To Reach						★★	★★	★★★★		
	MATERIAL	Carbon Steel	★★	★★★★	★★★★	★★★★	★★★★	★★	★★★★	★★★★	★★★★
Stainless Steel		★★★★	★★	★★			★★★★	★★	★★	★★	★
Aluminum / Non-Ferrous		★★★★					★★★★				
Non-Ferrous / Exotic		★★★★					★★★★				
Cast Iron		★★★★		★★			★★★★			★★	



# STYLES

## CONICAL STYLE Type 29



Maximum aggression for fast stock removal. Used on both flat surface and edge work. The angle provides greater surface contact for stock removal on flat surfaces.

## FLAT STYLE Type 27



Smooth grinding, blending and finishing. Used primarily on flat surfaces and slight contours.

## FLAT STYLE HD Type 27



Maximum conformability and life. Provides smooth grinding, blending and finishing on flat and irregular surfaces. Larger flaps ensure more contact and extend life.

## ANGLED STYLE



Curved flaps contour perfectly for fillet weld grinding while also allowing for efficient flat surface grinding.

# GRIT & GRAIN

## GRIT SIZE BY DESIRED FINISH

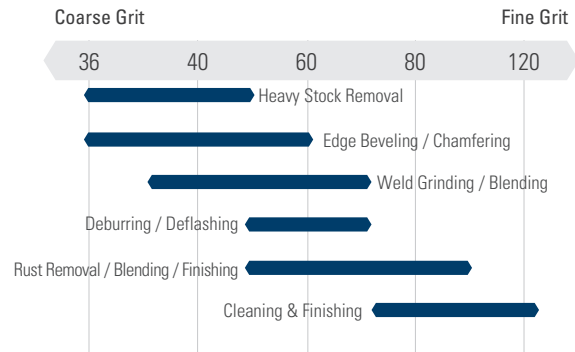

## CERAMIC ALUMINA (CA)

- Self-sharpening multi crystals with predetermined fracture points
- Self-sharpening
- Maintains cut-rate for 75% of life



## ALUMINUM OXIDE (AO)

- Single crystal
- Durable for short term grinding
- Hard
- Inexpensive

## WEILER X3 TECHNOLOGY

- Proprietary mix of Ceramic and Zirconia Alumina
- Triple split grain anchoring system
- Dual flap design
- Grinds faster AND lasts longer



## ZIRCONIA ALUMINA (ZA)

- Self-sharpening multi crystals
- Holds up under extreme pressure
- Self-sharpening
- Sharper, faster cut

# BACKING

## PHENOLIC

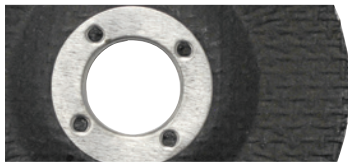

Prevents backing from scratching the workpiece.

## ALUMINUM



Rigid support for maximum aggression; recyclable.

## COMPOSITE\*



Trimable, non-marking backing; allows access to hard-to-reach areas.

\*BobCat™ Discs are not Trimable.

# ARBOR

## 5/8" - 11 NUT

- Quick change over
- Eliminates cross-threading experienced with plastic backs
- Metal nut eliminates the disc from sticking to the grinder due to heat build up

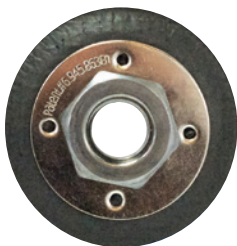

## 5/8" & 7/8" ARBOR

- Cost-effective
- Requires adapting nuts



Mounting Flap Discs with 5/8" & 7/8" Arbors

- Adapting Nut
- Abrasive Flap Disc
- Adapting Nut
- Right Angle Grinder

## MANDRELS & METAL HUB PADS

- For quick-change on tools with 1/4" collets



Type R hub pad + mandrel

Type S hub pad + mandrel

Type S mandrel

# TIGER® FLAP DISCS / PERFORMANCE LINE



MADE IN  
**USA**  
WITH GLOBAL  
MATERIALS



Grinding & blending a weld between two steel plates.

**UNLEASH TIGER X:** Tiger X flap discs raise the bar for those who are driven to get the job done right and done fast. Tiger X holds nothing back with its industry-first X3 technology that combines an advanced anchoring system, dual flap design and engineered backing. The combination delivers fast grinding AND long disc life for increased productivity.

Tiger X delivers the ultimate productivity enhancing X-Factors so you can do more in less time while lowering your consumable costs.

- **Increased Productivity** – The combination of aggressive grinding and long disc life deliver the ultimate X-Factor, a disc that gets more done in less time.
- **Enhanced Worker Safety** – Increased aggression requires less force to get equal or better results. This means less stress and reduced fatigue.
- **Lower Consumable Costs** – The combination of extreme aggressive grinding and long disc life means you get more for your money.
- **Greater Versatility** – X3 technology allows for greater versatility, reducing the need to switch discs when changing applications.

### Applications

- Flat surface grinding
- Light pressure / blending
- Weld grinding / blending
- Heavy stock removal
- Deburring

TESTED. PROVEN. TIGER X WORKS FASTER, LONGER.

## TIGER X REMOVES UP TO 40% MORE MATERIAL

TOTAL GRAMS OF METAL REMOVED FROM WORKPIECE OVER LIFE OF FLAP DISC

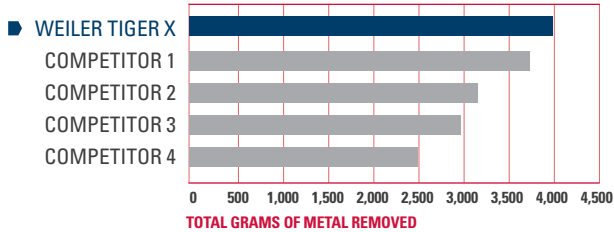

## GET UP TO 40% MORE FOR YOUR MONEY

TOTAL GRAMS OF METAL REMOVED FOR EVERY DOLLAR YOU SPEND

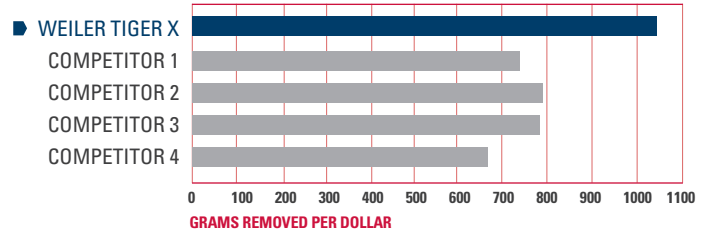

■ **Test Procedure:** Weiler Tiger X 4-1/2" Type 29 standard density flap disc vs. similar competing flap discs. Test grinder mounted at 15° angle against 1/2" workpiece with 15 pounds of pressure. Bi-directional 8" travel. Discs and workpiece weighed after 5 minute intervals for the life of the product. Tiger X usable life: 100 minutes. Competitors' usable life: 65 – 90 minutes.

Ceramic Alumina and Zirconia Alumina grain mix  
**Grinds Faster and Lasts Longer.**

Industry First

# X3

Technology

grain anchoring system,  
dual flap design,  
& engineered backing.





LIFE ●●●●●  
AGGRESSION ●●●●●

**P** **TIGER X FLAP DISCS** Conical Style (Type 29) / Phenolic Backing  
Designed for aggressive grinding and long life when used on Steel and Stainless Steel.

Diameter	Arbor Hole	Grit Size	Max. RPM	Standard Pack	Item Number
					Ceramic & Zirconia Alumina
4-1/2"	7/8"	36	13,000	10	51200
		40			51201
		60			51202
		80			51203
					51204
4-1/2"	5/8"-11 Nut	36	13,000	10	51205
		40			51206
		60			51207
		80			51208
					51209
5"	7/8"	36	12,000	10	51210
		40			51211
		60			51212
		80			51213
					51214
5"	5/8"-11 Nut	40	12,000	10	51215
		60			51216
		80			51217
					51218
					51219
7"	7/8"	36	8,600	10	51220
		40			51221
		60			51222
		80			
7"	5/8"-11 Nut	36	8,600	10	51223
		40			51224
		60			51225
		80			51226
					51227



51205



51216

**P** **TIGER X FLAP DISCS** Flat Style (Type 27) / Phenolic Backing  
Ideal working angle of less than 15° provides smooth grinding when used on Steel and Stainless Steel.

Diameter	Arbor Hole	Grit Size	Max. RPM	Standard Pack	Item Number
					Ceramic & Zirconia Alumina
4-1/2"	7/8"	40	13,000	10	51223
		60			51224
		80			51225
4-1/2"	5/8"-11 Nut	40	13,000	10	51226
		60			51227
		80			51228
					51229
7"	7/8"	40	8,600	10	51230
		60			51231
		80			51232
					51233
7"	5/8"-11 Nut	40	8,600	10	51234
		60			
		80			



51229

**Easy To Display Boxes**  
Tear the top off the Tiger X standard pack box and turn it into a counter or shelf display.



Key:

**P** PERFORMANCE LINE Industrial Grade    **V** VALUE LINE Professional Grade

WHY WEILER

BONDED ABRASIVES

COATED ABRASIVES

NON-WOVEN ABRASIVES

POWER BRUSHES

NYLON BRUSHES



Blending the weld of a steel frame prior to painting.



Weiler's Original Tiger flap discs are the brand you have trusted for over 20 years and THE flap discs that set the standard in the industry for performance, consistency, reliability and quality. Aluminum back flap discs are the benchmark for the pipeline industry, among others, providing rigid support for maximum aggression.

**MADE IN USA**  
WITH GLOBAL MATERIALS

### APPLICATIONS

- Flat surface grinding
- Weld grinding / blending
- Edge grinding
- Light pressure / blending
- Heavy stock removal
- Pipeline

- LIFE ●●●●●●●●
- AGGRESSION ●●●●●●●●
- PIPELINE USE ●●●●●●●●

### **P** TIGER DISC FLAP DISCS Conical Style (Type 29) / Phenolic & Aluminum Backing

Designed for the industrial user who values high cut rate and long life.



50601



50519



50543

Dia.	Arbor Hole	Grit Size	Max. RPM	Standard Pack	Item Number		
					Phenolic Backing		Aluminum Backing
					Zirconia Alumina	Alum. Oxide	Zirconia Alumina
4	5/8"	36	15,000	10	50592	50552	50502
		40			50593	50553	50503
		60			50594	50554	50504
		80			50595	50555	50505
		120			—	—	50506
4-1/2"	7/8"	24	13,000	10	50601	—	50511
		36			—	50562	50512
		40			—	50563	50513
		60			—	50564	50514
		80			—	50565	50515
		120			50606	—	50516
4-1/2"	5/8"-11 Nut	24	13,000	10	—	—	50510*
		36			—	—	50517*
		40			—	—	50518*
		60			—	—	50519*
		80			—	—	50520*
		120			—	—	50509*
5"	7/8"	36	12,000	10	—	50572	50522
		40			—	50573	50523
		60			—	50574	50524
		80			—	50575	50525
		120			50616	—	50526
6"	7/8"	40	10,200	10	50649	—	—
		60			50650	—	—
		80			50651	—	—
6"	5/8"-11 Nut	40	10,200	10	50659	—	—
		60			50660	—	—
		80			50661	—	—
7"	7/8"	36	8,600	10	—	50582	50532
		40			—	50583	50533
		60			—	—	50534
		80			—	50585	—
		120			—	—	50536
7"	5/8"-11 Nut	24	8,600	10	—	—	50541*
		36			—	50632*	50542*
		40			—	50633*	50543*
		60			—	50634*	50544*
		80			—	50635*	50545*
		120			—	—	50546*

\* Patent # 6,945,863





## TIGER DISC FLAP DISCS Flat Style (Type 27) / Phenolic Backing

High stock removal, long life and flexibility.



Diameter	Arbor Hole	Grit Size	Max. RPM	Standard Pack	Item Number	
					Zirconia Alumina	Alum. Oxide
4"	5/8"	40	15,000	10	50693	50653
		60			50694	50654
		80			50695	50655
		120			50696	—
4-1/2"	7/8"	40	13,000	10	—	50663
		60			—	50664
		80			—	50665
		120			50706	—
4-1/2"	5/8"-11 Nut	40	13,000	10	—	50668*
		60			—	50669*
		80			—	50670*
		120			50699*	—
5"	7/8"	40	12,000	10	50713	50673
		60			50714	50674
		80			50715	50675
7"	7/8"	40	8,600	10	—	50683
		60			—	50684
7"	5/8"-11 Nut	40	8,600	10	—	50733*
		60			—	50734*
		80			—	50735*
		120			50746*	—

\* Patent # 6,945,863



50706

## ADAPTING NUTS & SPANNER WRENCH

For use with Tiger, High Density and Vortec Pro Flap Discs.

Description	Thread Size	For Use With	Standard Pack	Item Number
Adapting Nuts	3/8" - 24	4" Flap Disc with 5/8" arbor hole (can be used with an adjustable or combination wrench)	1	56484
Adapting Nuts	5/8" - 11	4-1/2", 5" & 7" Flap Discs with 7/8" arbor hole	1	56494
Spanner Wrench	—	Item No. 56494 only	1	56495

When mounting, adapters must be nested, see illustration below.



56494

56495



WHY WEILER BONDED ABRASIVES

COATED ABRASIVES

NON-WOVEN ABRASIVES

POWER BRUSHES

NYLOX BRUSHES

PACKAGED ITEMS

MAINTENANCE



Blending and finishing a weld.



Weiler's Big Cat flap discs offers the widest footprint in the industry. The wider flaps better conform to curved and irregular surfaces, producing a consistent finish and lasting 30-40% longer than a standard flap disc.

**MADE IN USA**  
WITH GLOBAL MATERIALS

### APPLICATIONS

Provides increased conformability and long life when:

- Flat surface grinding
- Weld grinding / blending
- Irregular surface
- Light pressure / blending
- Heavy stock removal

### FEATURES AND BENEFITS

Enhanced **conformability** helps reduce gouging and undercutting.

Thicker phenolic back (more layers of fiberglass) than competitors, provides **more stability** for the thicker cloth configuration.

**Largest flap area** in the industry as a result of the unique combination of flap count, height and width.

**Longest lasting** high density discs provide as much as 20% more life than the top competitors discs.

Big Cat is well known in the industry – ask for it by name for **increased productivity**, reduced operating cost and maximum disc life.

**Big Cat HD Flap Disc**

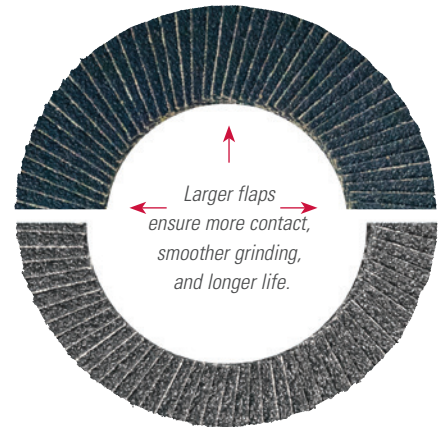

**Competitors HD Flap Disc**

LIFE ●●●●●  
AGGRESSION ●●●●●  
CONFORMABLE ●●●●●

### **P** BIG CAT FLAP DISCS Flat Style (Type 27) / Phenolic Backing

Increased conformability and maximum life.

Diameter	Arbor Hole	Grit Size	Max. RPM	Standard Pack	Item Number	
					Zirconia Alumina	Aluminum Oxide
4-1/2"	7/8"	40	12,000	10	50803	50763
		60			50804	50764
		80			50805	50765
		120			50806	—
4-1/2"	5/8"-11 Nut	40	12,000	10	50808*	50768*
		60			50809*	50769*
		80			50810*	50770*
7"	7/8"	40	8,600	10	50823	50783
		60			50824	50784
		80			50825	—
		120			—	50786
7"	5/8"-11 Nut	40	8,600	10	50843*	50833*
		60			50844*	50834*
		80			50845*	—
		120			50846*	—

\*Patent # 6,945,863



50804



50823

Key:

**P** PERFORMANCE LINE Industrial Grade    **V** VALUE LINE Professional Grade





Weiler's Trimmable Tiger flap discs are designed for hard-to-reach areas such as fillet welds and irregular shapes while grinding on-edge without changing tools. The unique composite backing can be trimmed, exposing more abrasive material and extending disc life, resulting in lower grinding and finishing costs. The backing can be trimmed up to 3/8" from the original diameter, dramatically extending flap length for grinding into fillet welds.

**MADE IN USA**  
WITH GLOBAL MATERIALS



To trim backing, run against a sharp edge until desired backing diameter is achieved.

**APPLICATIONS**

- Light pressure / blending
- Weld grinding / blending
- Heavy stock removal
- Fillet grinding
- Irregular surface



A trimmed back dramatically extends disc life, allowing the operator to use the entire flap while maintaining a consistent working angle.

- LIFE ●●●●●●●●●●
- AGGRESSION ●●●●●●●●●●
- VERSATILITY ●●●●●●●●●●

**P TRIMMABLE TIGER FLAP DISCS** Conical Style (Type 29) / Composite Backing  
High stock removal, long life and flexibility, ideal for working into fillet welds.

Diameter	Arbor Hole	Grit Size	Max. RPM	Standard Pack	Item Number
					Zirconia Alumina
4-1/2"	7/8"	40	13,000	10	50002
		60			50003
		80			50004
		120			50005
		40			50006*
4-1/2"	5/8"-11 Nut	60	13,000	10	50007*
		80			50008*
		120			50009*
		40			50010
		60			50011
5"	7/8"	80	12,000	10	50012
		40			50014
		60			50015
5"	5/8"-11 Nut	80	12,000	10	50016
		40			
		60			

\*Patent # 6,945,863



50002

COATED ABRASIVES  
NON-WOVEN ABRASIVES  
POWER BRUSHES  
NYLOX BRUSHES  
PACKAGED ITEMS  
MAINTENANCE

*"We get a competitive edge with Weiler because their prices are competitive but they last far longer."*

- **Jim Martin**, Vice President, Karnel Incorporated





Blending fillet welds to ensure proper penetration prior to inspection.



**NEW!** Tiger Angled flap discs deliver an aggressive, long life solution for grinding fillet welds, T-joints and other hard-to-reach places. The 90° angled flap design forms perfectly into angles while the phenolic back provides stability to the flaps. This combination optimizes flap-to-metal contact, resulting in exceptional feel and control for the operator while grinding and finishing.

*Tiger Angled Delivers a Competitive Advantage:*

- **Aggressive Grinding** – Tiger Angled attacks metal, removing more material in less time so you get the job done faster
- **Long Life** – Keeps you grinding longer on Steel, Stainless, Aluminum and other hard-to-grind metals, lowering cost of use
- **Flexibility of Approach** – Angled flaps allow the operator to grind at a higher or lower angle, getting into hard-to-reach places more easily
- **Smooth Finish** – While grinding fillet welds, the angled flaps reduce the risk of gouging the work-piece
- **Mounting Options** – Available in 7/8" arbor or with a 5/8" -11 nut for fast change-over

## GET MORE DONE, FASTER

Tiger Angled removes more metal in less time, while grinding fillet welds.

### MATERIAL REMOVED IN 1 MINUTE

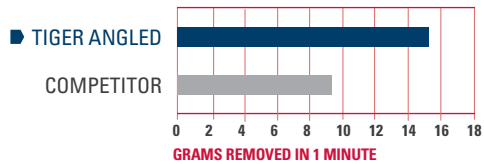

### MATERIAL REMOVED OVER THE LIFE OF THE DISC

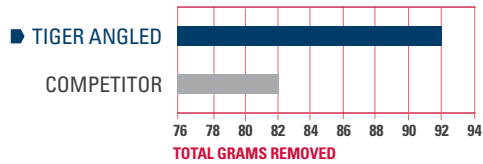

*Test Procedure: Weiler Tiger 4-1/2", 60 grit Ceramic Angled flap disc vs. similar competing flap discs on 90° fillet weld. Disc and workpiece weighed after 1 minute of operation for life of product.*

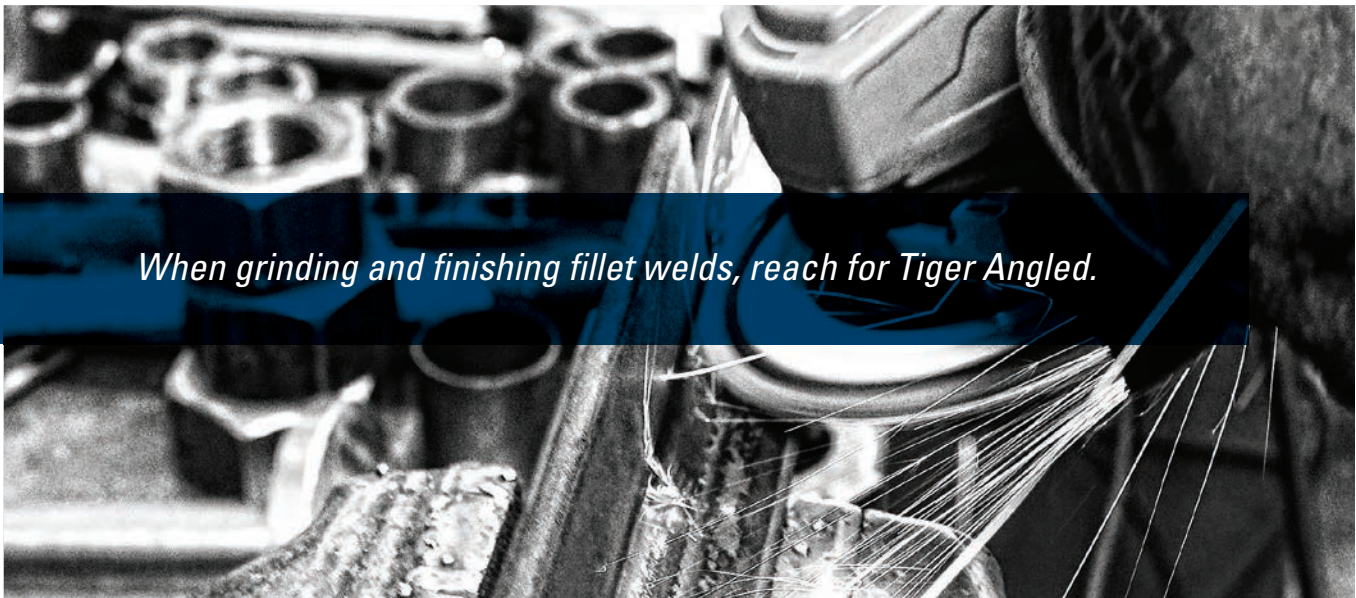

*When grinding and finishing fillet welds, reach for Tiger Angled.*



**Tiger Angled is ideal for the following applications:**

- Fillet welds
- T-Joints
- Hard-to-reach places
- Repair and re-work

**SMOOTH FINISH**

when grinding Fillet welds & T-joints

**FLEXIBILITY OF APPROACH**

flap design allows you to grind from a wider range of angles

**MORE GRIT OPTIONS**

gives you the finish and aggression you want

**ATTACKS METAL**

removing more material in less time

**TOP COAT** (Ceramic only) grinds cooler to protect valuable parts and prevents loading on softer alloys



WHY WEILER BONDED ABRASIVES

COATED ABRASIVES

**NEW!**

**P**

**CERAMIC ANGLED FLAP DISCS** Phenolic Backing

Top-sized Ceramic Alumina grain offers a contaminant-free option for Stainless Steel applications. Grinds cool, delivering maximum performance on Inconel, Titanium and other hard-to-grind metals.

Diameter	Arbor Hole	Grit Size	Max. RPM	Standard Pack	Item Number
4-1/2"	7/8"	40	13,000	10	Ceramic Alumina
		60			51312
		80			51313
4-1/2"	5/8"-11 Nut	40	13,000	10	51314
		60			51315
		80			51316
5"	7/8"	40	12,000	10	51317
		60			51318
		80			51319
5"	5/8"-11 Nut	40	12,000	10	51320
		60			51321
		80			51322
					51323



LIFE ●●●●●  
 AGGRESSION ●●●●●  
 VERSATILITY ●●●●●



51318

NON-WOVEN ABRASIVES

POWER BRUSHES

**NEW!**

**P**

**ZIRCONIUM ANGLED FLAP DISCS** Phenolic Backing

Zirconia Alumina grains are self-sharpening, delivering an aggressive, long life option that will continue to remove material over the entire life of the disc.

Diameter	Arbor Hole	Grit Size	Max. RPM	Standard Pack	Item Number
4-1/2"	7/8"	40	13,000	10	Zirconia Alumina
		60			51300
		80			51301
4-1/2"	5/8"-11 Nut	40	13,000	10	51302
		60			51303
		80			51304
5"	7/8"	40	12,000	10	51305
		60			51306
		80			51307
5"	5/8"-11 Nut	40	12,000	10	51308
		60			51309
		80			51310
					51311



LIFE ●●●●●  
 AGGRESSION ●●●●●  
 VERSATILITY ●●●●●



51304

NYLOX BRUSHES

PACKAGED ITEMS

MAINTENANCE



Grinding and beveling stainless steel tubing with a Saber Tooth abrasive flap disc.



Weiler's Saber Tooth flap discs deliver real performance on Stainless Steel, Aluminum, Inconel, Titanium and other hard-to-grind metals. A grinding aid protects high value parts from heat discoloration and the self-sharpening Ceramic Alumina grain provides cool, fast-cutting action, allowing you to do more work, more quickly. Discs are contaminant free, with Iron, Sulfur and Chlorine  $\leq 0.1\%$ .

**MADE IN USA**  
WITH GLOBAL MATERIALS

### APPLICATIONS

- Flat surface grinding
- Light pressure / blending
- Weld grinding / blending
- Heavy stock removal
- Edge grinding
- Fillet grinding
- Irregular surface

LIFE ●●●●●●●●●●  
AGGRESSION ●●●●●●●●●●  
USE ON SS / AL ●●●●●●●●●●



50102

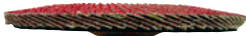

### **P** SABER TOOTH FLAP DISCS Conical Style (Type 29) / Phenolic Backing

Cool, fast cutting on hard-to-grind metals.

Diameter	Arbor Hole	Grit Size	Max. RPM	Standard Pack	Item Number
					Ceramic Alumina
4-1/2"	7/8"	36	13,000	10	50100
		40			50101
		60			50102
		80			50103
4-1/2"	5/8"-11 Nut	36	13,000	10	50104*
		40			50105*
		60			50106*
		80			50107*
7"	7/8"	36	8,600	10	50108
		40			50109
		60			50110
		80			50111
7"	5/8"-11 Nut	36	8,600	10	50112*
		40			50113*
		60			50114*
		80			50115*



50121

LIFE ●●●●●●●●●●  
AGGRESSION ●●●●●●●●●●  
USE ON SS / AL ●●●●●●●●●●

### **P** SABER TOOTH TRIM FLAP DISCS Conical Style (Type 29) / Composite Backing

Cool, fast cutting on hard-to-grind metals. High stock removal, long life and flexibility.

Diameter	Arbor Hole	Grit Size	Max. RPM	Standard Pack	Item Number
					Ceramic Alumina
4-1/2"	7/8"	40	13,000	10	50117
		60			50118
		80			50119
		40			50121*
4-1/2"	5/8"-11 Nut	60	13,000	10	50122*
		80			50123*



50139



### **P** SABER TOOTH HIGH DENSITY (HD) FLAP DISCS

Flat Style (Type 27) / Phenolic Backing / Cool, fast cutting on hard-to-grind metals. Increases conformability and provides 30-40% longer life than standard (Type 29) flap discs.

Diameter	Arbor Hole	Grit Size	Max. RPM	Standard Pack	Item Number
					Ceramic Alumina
4-1/2"	7/8"	40	13,000	10	50130
		60			50131
		80			50132
4-1/2"	5/8"-11 Nut	40	13,000	10	50133*
		60			50134*
		80			50135*
7"	7/8"	40	8,600	10	50136
		60			50137
		80			50138
7"	5/8"-11 Nut	40	8,600	10	50139*
		60			50140*
		80			50141*



\*Patent # 6,945,863



**NEW!** Tiger BobCat mini flap discs deliver enhanced performance - **1-1/2 TIMES THE LIFE** from the previous generation. The expanded line now offers a male "Type R" thread mount in addition to the current "Type S" mount. These discs are designed for use on right angle die grinders to provide smooth grinding and enhanced conformability in tight areas.

**PRODUCT FEATURES & BENEFITS**

- **Increased Life** – Improved design delivers twice the life of the original Bobcat as well as blending discs
- **Aggressive Grinding** – Designed to shed cloth and expose new grain, delivering faster blending and stock removal than blending discs
- **Mounting Options** – Type S and Type R quick-change mounting options are available

**APPLICATIONS**

- Grinding and finishing in hard-to-reach areas
- Grinding, deburring and blending
- Metal fabrication, weld blending or edge chamfering



Edge chamfering a fabricated stainless component.



COATED ABRASIVES  
 NON-WOVEN ABRASIVES  
 POWER BRUSHES  
 NYLOX BRUSHES  
 PACKAGED ITEMS  
 MAINTENANCE

**P BOBCAT MINI FLAP DISCS - TYPE S**

Zirconia Alumina - Plastic Backing / Compatible with Norton Speed-Lok® TS back-up pads\*  
 Ideal for tight spaces and in heavy-duty applications where blending discs do not hold up.

Diameter	Grit Size	Max. RPM	Standard Pack	Item Number	
				Type 29	Type 27
2"	36	30,000	10	50922	50932
	40			50923	50933
	60			50924	50934
	80			50925	50935
	120			—	50936
3"	36	20,000	10	50902	50912
	40			50903	50913
	60			50904	50914
	80			50905	50915
	120			50906	50916

\* Back-up pad not required if used with Type S mandrel



**NEW! COMING SPRING 2017**

**P BOBCAT MINI FLAP DISCS - TYPE R**

Zirconia Alumina - Plastic Backing / Compatible with 3M Roloc™ back-up pads†  
 Ideal for tight spaces and in heavy-duty applications where blending discs do not hold up.

Diameter	Grit Size	Max. RPM	Standard Pack	Item Number	
				Type 29	Type 27
2"	36	30,000	10	50946	50956
	40			50947	50957
	60			50948	50958
	80			50949	50959
	120			50950	50960
3"	36	20,000	10	50951	50961
	40			50952	50962
	60			50953	50963
	80			50954	50964
	120			50955	50965

† Back-up pad required



**BOBCAT DRIVE MANDRELS & METAL HUB PADS**

For quick-change on tools with 1/4" collets.

Description	Standard Pack	Item Number
2" & 3" Type S Mandrel	1	07766
2" Type S hub pad + Mandrel	1	60508
3" Type S hub pad + Mandrel	1	60509
2" Type R hub pad + Mandrel	1	06777
3" Type R hub pad + Mandrel	1	06788



# TIGER PAW™ FLAP DISCS / PERFORMANCE LINE



Weiler's Tiger Paw flap discs are designed for the user looking for aggressive performance and long life in heavy-duty applications like **grinding on the edge of pipe**.

**MADE IN USA**  
WITH GLOBAL MATERIALS

**100% Zirconia Alumina grain** is fast cutting with long life, resulting in fewer changeovers and increased productivity.

**Superior grain retention** - lasts longer and maintains perfect cutting angle to provide excellent performance and sustained stock removal when grinding on-edge while the engineered poly/cotton cloth features excellent grain retention for maximum disc life.

## APPLICATIONS

- Light pressure / blending
- Heavy stock removal
- Irregular surface
- Weld grinding / blending
- Edge grinding



Beveling pipe on edge with a Tiger Paw flap disc.

## TIGER PAW REMOVES MORE MATERIAL

TOTAL GRAMS OF METAL REMOVED FROM WORKPIECE OVER LIFE OF FLAP DISC

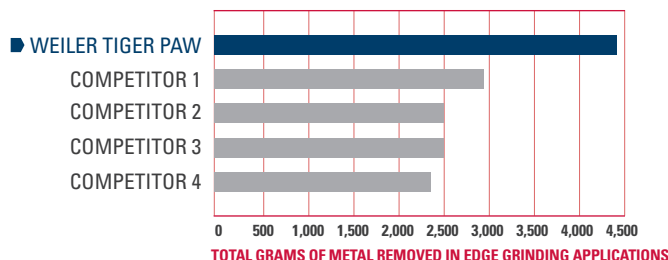

TOTAL GRAMS OF METAL REMOVED IN EDGE GRINDING APPLICATIONS

**Test Procedure:** Weiler Tiger Paw 4-1/2" Type 29 standard density flap disc vs. similar competing flap discs. Test grinder mounted at 15° angle against 1/8" workpiece with 15 pounds of pressure. Bi-directional 8" travel. Discs and workpiece weighed after 5 minutes intervals for the life of the product. Tiger Paw usable life: 17 minutes. Competitors' usable life: 8 - 10 minutes.

## GET MORE FOR YOUR MONEY

TOTAL GRAMS OF METAL REMOVED FOR EVERY DOLLAR YOU SPEND

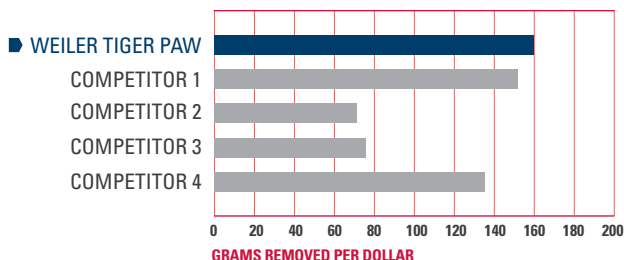

LIFE ●●●●●●●●●●  
AGGRESSION ●●●●●●●●●●  
EDGE GRINDING ●●●●●●●●●●

## TIGER PAW FLAP DISCS Conical Style (Type 29) / Phenolic Backing

Aggressive action and long life; for heavy-duty applications on Steel and Stainless.



Diameter	Arbor Hole	Grit Size	Max. RPM	Standard Pack	Item Number
					Zirconia Alumina
4"	5/8"	40	15,000	10	51104
		60			51105
4-1/2"	7/8"	36	13,000	10	51118
		40			51119
		60			51120
		80			51121
		36			51123*
4-1/2"	5/8"-11 Nut	40	13,000	10	51124*
		60			51125*
		80			51126*
		36			51129
		40			51130
5"	7/8"	40	12,000	10	51153*
		60			51132*
		80			51133*
		36			51154*
		40			51145
5"	5/8"-11 Nut	40	12,000	10	51150
		60			51149*
		80			51146*
		36			51147*
		40			51148*
7"	7/8"	40	8,600	10	51145
		60			51150
		80			51149*
		36			51146*
		40			51147*
7"	5/8"-11 Nut	40	8,600	10	51145
		60			51149*
		80			51146*
		36			51147*
		40			51148*

\*Patent # 6,945,863



51118



51147



**P TIGER PAW FLAP DISCS** Flat Style (Type 27) / Phenolic Backing  
Smooth action and long life; for heavy-duty applications on Steel and Stainless.

Diameter	Arbor Hole	Grit Size	Max. RPM	Standard Pack	Item Number	
					Zirconia Alumina	
4"	5/8"	40	15,000	10	51101	
		60			51102	
4-1/2"	7/8"	36	13,000	10	51107	
		40			51108	
		60			51109	
		80			51110	
4-1/2"	5/8"-11 Nut	36	13,000	10	51112*	
		40			51113*	
		60			51114*	
		80			51115*	
5"	7/8"	40	12,000	10	51134	
		60			51135	
5"	5/8"-11 Nut	36	12,000	10	51155*	
		40			51156*	
		60			51157*	
		80			51158*	
7"	7/8"	40	8,600	10	51137	
		60			51138	
7"	5/8"-11 Nut	36	8,600	10	51139*	
		40			51140*	
		60			51142*	
		80			51143*	

\*Patent # 6,945,863



51115

## HIGH DENSITY

Tiger Paw Extreme High Density flap discs feature thicker and larger flaps that conform to curved and irregular surfaces while producing a consistent finish. These high density flap discs are designed for the user looking for **extended life and conformability** in heavy-duty applications.

- 40% more abrasive cloth than a standard flap disc.
- 100% Zirconia Alumina grain provides superior edge grinding.
- Engineered poly/cotton cloth features excellent grain retention for maximum disc life.

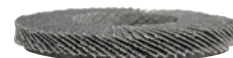

**P TIGER PAW HD FLAP DISCS** Flat Style (Type 27) / Phenolic Backing  
Extended life and conformability; for heavy-duty applications on Steel and Stainless Steel.

Diameter	Arbor Hole	Grit Size	Max. RPM	Standard Pack	Item Number	
					Zirconia Alumina	
4-1/2"	7/8"	36	12,000	10	51160	
		40			51161	
		60			51162	
		80			51163	
4-1/2"	5/8"-11 Nut	36	12,000	10	51164*	
		40			51165*	
		60			51166*	
		80			51167*	
7"	7/8"	40	8,600	10	51170	
		60			51171	
7"	5/8"-11 Nut	40	8,600	10	51168*	
		60			51169*	

\*Patent # 6,945,863



51168

# WOLVERINE™ FLAP DISCS / VALUE LINE



Grinding welds on a fabricated steel part.



Formerly Vortec Pro®

MADE IN  
**USA**  
WITH GLOBAL  
MATERIALS

**NEW!** Wolverine flap discs are designed to deliver fast material removal and consistent performance at a great value. Formerly Vortec Pro, Wolverine gets the job done for fabrication professionals, aggressively grinding and blending carbon and stainless steel in every-day applications.

## BENEFITS OF WOLVERINE FLAP DISCS

- **Fast Cut Rate** – Zirconia Alumina grain is self-sharpening, delivering aggressive grinding from start to finish
- **Versatility** – Choose from conical or flat styles for optimal angle of approach and desired finish as well as a variety of backing options, arbors and available diameters to fit all tool sizes.
- **Fast Change Over** – Quick-change 5/8" -11 nut available in addition to 5/8" and 7/8" arbors

## APPLICATIONS

- Flat surface grinding
- Light pressure / blending
- Weld grinding / blending
- General stock removal
- Irregular surface (HD Discs)

LIFE ●●●●●  
AGGRESSION ●●●●●  
VALUE ●●●●●

**NEW!**



## WOLVERINE FLAP DISCS Conical Style (Type 29) / Zirconia Alumina

Delivers a high cut rate and steeper angle of attack for more aggressive grinding at a value price. Ideal for general stock removal and weld blending.



31350



31332

Diameter	Arbor Hole	Grit Size	Max. RPM	Standard Pack	Item Number	
					Phenolic Backing	Aluminum Backing
4"	5/8"	36	15,000	10	31337	—
		40			31338	—
		60			31339	—
		80			31340	—
		120			—	—
4-1/2"	7/8"	36	13,000	10	31343	31307
		40			31344	31308
		60			31345	31309
		80			31346	31310
		120			31347	—
4-1/2"	5/8"-11 Nut	36	13,000	10	31349*	31313*
		40			31350*	31314*
		60			31351*	31315*
		80			31352*	31316*
		120			31353*	31317*
5"	7/8"	36	12,000	10	31355	—
		40			31356	—
		60			31357	—
		80			31358	—
7"	7/8"	36	8,600	10	31361	—
		40			31362	—
		60			31363	—
		80			31364	—
7"	5/8"-11 Nut	36	8,600	10	31367*	31331*
		40			31368*	31332*
		60			31369*	31333*
		80			31370*	31334*

\*Patent # 6,945,863





**NEW!**



**WOLVERINE FLAP DISCS Flat Style (Type 27) / Zirconia Alumina**

Delivers a smooth grinding action at a value price. Ideal for light pressure grinding, blending and finishing.

Diameter	Arbor Hole	Grit Size	Max. RPM	Standard Pack	Item Number
					Phenolic Backing
4-1/2"	7/8"	36	13,000	10	31401
		40			31402
		60			31403
		80			31404
		36			31407*
4-1/2"	5/8"-11 Nut	40	13,000	10	31408*
		60			31409*
		80			31410*
		40			31414
		60			31415
7"	7/8"	40	8,600	10	31419*
		60			31420*
		80			31421*
7"	5/8"-11 Nut	40	8,600	10	31422*
		60			
		80			

\*Patent # 6,945,863



31409

**HIGH DENSITY**

**NEW!**



**WOLVERINE HD FLAP DISCS Flat Style (Type 27) / Zirconia Alumina**

Delivers increased life and conformability over standard density Wolverine flap discs at a value price. Ideal for irregular or contoured surfaces.

Diameter	Arbor Hole	Grit Size	Max. RPM	Standard Pack	Item Number
					Phenolic Backing
4-1/2"	7/8"	40	12,000	10	31387
		60			31388
		80			31389
4-1/2"	5/8"-11 Nut	40	12,000	10	31390*
		60			31391*
		80			31392*

\*Patent # 6,945,863



31390



# RESIN FIBER DISCS

Weiler's premium resin fiber discs are suitable for light grinding, blending, surface preparation and finishing on a variety of materials.

## Applications

### Saber Tooth™ Ceramic Alumina:

Cool, fast cutting action on Aluminum, Stainless Steel and other hard-to-grind metals.

### Zirconia Alumina:

High performance grinding of Stainless Steel, Tool Steel and hard-to-grind materials.

### Aluminum Oxide:

All purpose weld blending, grinding, surface preparation and finishing of metals, plastic, wood and fiberglass.



Blending welds on the corner of a steel furniture frame.

## **P** Saber Tooth Resin Fiber Discs

These coated abrasive discs are designed for cool, fast weld blending, grinding, surface preparation and finishing on Aluminum, Stainless Steel and other hard-to-grind metals.



59557

Diameter	Arbor Hole	Grit Size	Standard Pack	Item Number - Ceramic Alumina
4-1/2"	7/8"	24	25	59550
		36		59551
		50		59552
		60		59553
		80		59554
5"	7/8"	24	25	59557
		36		59558
		50		59559
		60		59560
		80		59561
7"	7/8"	24	25	59564
		36		59565
		50		59566
		60		59567
		80		59568

## **P** Resin Fiber Discs - Ideal for blending, finishing and surface preparation.



59732



59503

Diameter	Arbor Hole	Grit Size	Standard Pack	Item Number	
				Zirconia Alumina	Aluminum Oxide
4"	5/8"	24	25	—	59491
		36		—	59492
		50		—	59493
		60		—	59494
		80		—	59495
		120		—	59497
4-1/2"	7/8"	24	25	59731	59571
		36		59732	59573
		50		59733	59575
		60		—	59576
		80		—	59577
		100		—	59578
5"	7/8"	120	25	—	59579
		16		—	59500
		24		59701	59501
		36		59702	59503
		50		—	59505
		60		—	59506
7"	7/8"	80	25	—	59507
		100		—	59508
		16		—	59520
		24		59711	59521
		36		59712	59523
		50		—	59525
9"	7/8"	60	25	—	59526
		80		—	59527
		100		—	59528
		120		—	59529
		36		—	59543
		—		—	—

Do not exceed maximum RPM of back-up pad.

## NOTE

See back-up pads on page 43.



# AL-TRA CUT™ DISCS - FOR GRINDING ALUMINUM

Weiler's Al-tra CUT discs are specially formulated for superior grinding performance on Aluminum. AL-tra CUTs **improve grinding on Aluminum 400-800%!** These revolutionary discs resist loading, ensure higher cut rates, prolong disc life and achieve a superior finish compared to conventional sanding and grinding discs in the market. AL-tra CUT discs outlast conventional resin fiber discs 5 to 1.

## Aluminum Applications

- Weld blending
- Grinding
- Deburring
- Finishing

## MATERIAL REMOVED vs. TIME

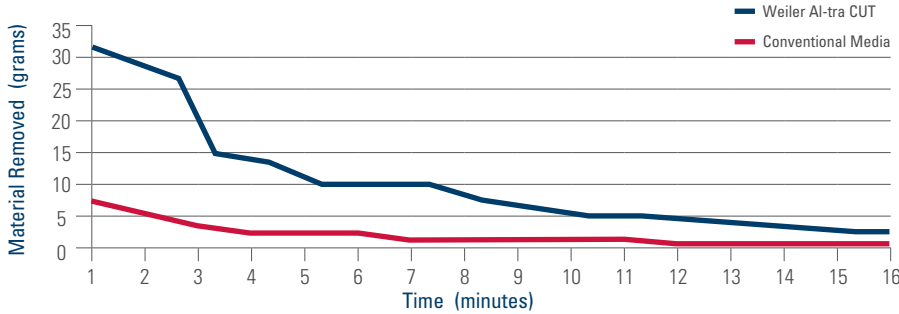

Blending welds and saw marks on a mounting bracket.

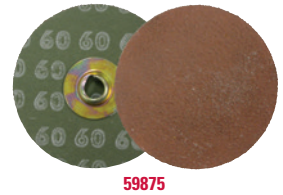

COATED ABRASIVES  
NON-WOVEN ABRASIVES  
POWER BRUSHES  
NYLON BRUSHES  
PACKAGED ITEMS  
MAINTENANCE

## P 2" & 3" AL-TRA CUT DISCS - Aluminum Oxide

Diameter	Grit Size	Standard Pack	Item Number	
			Type R Hub Style*	Type S Hub Style +
2"	36	50	59806	59869
	60		59807	59870
	80		59808	59871
	120		59809	-
3"	36	25	59811	59874
	60		59812	59875
	80		59813	59876
	120		59814	59877
2" & 3" Back-up - 1/4" stem				
Diameter	Max. RPM	Std. Pack		
2"	25,000	1	51551	60508
3"	20,000	1	51552	60509

Do not exceed maximum RPM of back-up pad. Do not store AL-tra CUT Discs above 120° F.  
 \* Compatible with 3M Roloc™ back-up pads. (Roloc™ is a trademark of 3M.)  
 + Compatible with Norton Speed-Lok® TS back-up pads. (Speed-Lok® TS is a registered trademark of Norton Co.)

## P 4-1/2" & 7" AL-TRA CUT DISCS - Aluminum Oxide

Diameter	Arbor Hole	Grit Size	Standard Pack	Item Number
4-1/2"	7/8"	36	25	59821
		60		59823
		80		59824
		120		59826
7"	7/8"	36	25	59862
		60		59864
		80		59865

Do not exceed maximum RPM of back-up pad. Do not store AL-tra Cut Discs above 120° F.

## P ACCESSORIES FOR RESIN FIBER & AL-TRA CUT DISCS

Description	Thread Size	Max. RPM	Standard Pack	Item Number
4" Back-up Pad	5/8"-11*	12,000	1	59605
4-1/2" Back-up Pad	5/8"-11*	11,000	1	59611
5" Back-up Pad	5/8"-11*	10,000	1	59600
7" Back-up Pad	5/8"-11	8,500	1	59601
9" Back-up Pad	5/8"-11	6,500	1	59602
Spanner Wrench	-	-	1	59603
Disc Nut	5/8"-11	-	1	59604

\* Other thread sizes available on special orders.

# BLENDING DISCS



Blending surface imperfections prior to painting.

Weiler's cloth backed coated abrasive discs are for use on right angle air tools. Available with either a metal hub or a plastic button fastening system, the flexible back-up pads give the discs a great deal of conformability. Weiler's blending discs are suitable for a wide range of light fabrication, repair and maintenance applications.

## Applications

### Saber Tooth™

**Ceramic Alumina:**  
Cool, fast cutting action on Aluminum, Stainless Steel and other hard-to-grind metals.

### Zirconia Alumina:

High performance grinding of Stainless Steel, Tool Steel and hard-to-grind materials.

### Aluminum Oxide:

All purpose weld blending, grinding, surface preparation and finishing of metals, plastic, wood and fiberglass.

## P SABER TOOTH CERAMIC ALUMINA BLENDING DISCS

For aluminum, stainless and other hard-to-grind metal applications.

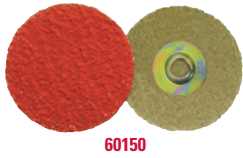

60150

Diameter	Grit Size	Standard Pack	Item Number	
			Type S Hub Style	Type R Hub Style
2"	36	100	60150	60170
	60		60151	60171
	80		60152	60172
3"	36	50	60155	60175
	60		60156	60176
	80		60157	60177

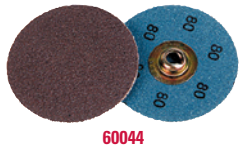

60044

## P BLENDING DISCS - Type S Hub Style

Compatible with Norton Speed-Lok® TS back-up pads.

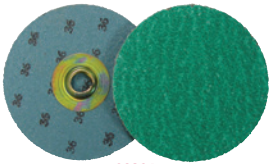

60391

Diameter	Grit Size	Standard Pack	Item Number	
			Zirconia Alumina	Aluminum Oxide
2"	36	100	60378	60040
	60		60381	60043
	80		60382	60044
	120		60384	60046
3"	36	50	60391	60053
	60		60394	60056
	80		60395	60057
	120		60397	60059

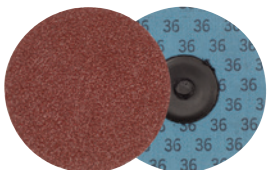

60131

## P BLENDING DISCS - Type R Hub Style - Compatible with 3M Roloc™ back-up pads.

Diameter	Grit Size	Standard Pack	Item Number - Aluminum Oxide	
			Type R Hub Style*	Type S Hub Style+
2"	36	100	60118	
	60		60121	
	80		60122	
	120		60124	
3"	36	50	60131	
	60		60134	
	80		60135	
	120		60137	



60508

## P BACK-UP PADS - 1/4" Stem

Diameter	Max. RPM	Std. Pack	Item No.	
			Type R Hub Style*	Type S Hub Style+
2"	25,000	1	51551	60508
3"	20,000	1	51552	60509

Do not exceed maximum RPM of back-up pad.

\* Compatible with 3M Roloc™ back-up pads. (Roloc™ is a trademark of 3M.)

+ Compatible with Norton Speed-Lok® TS back-up pads. (Speed-Lok® TS is a registered trademark of Norton Co.)



# TRIM-KUT® DISCS

Trim-Kuts are abrasive discs designed for light grinding and blending applications on a variety of materials. The abrasive grains are fused directly onto a wearable polymer backing, resulting in a disc that requires no back-up pad. The polymer backing trims during use to expose new grains to the work surface. 3" discs are designed for use on right angle air die grinders, and 4-1/2" discs are for use on right angle grinders.

## APPLICATIONS

- Edge blending
- Preparation for painting and surface finishing
- Light weld and stock removal
- Deburring



Deburring and chamfering a section of pipe after cutting.

### P TRIM-KUT DISCS - Aluminum Oxide

Diameter	Arbor Hole	Grit Size	Max. RPM	Standard Pack	Item Number
3"	5/16" - 18	36	21,000	25	59300
		60			59305
		120			59315

Do not use TRIM-KUT discs in temperatures lower than 48° fahrenheit. Store at 50% relative humidity.



59300

### P TRIM-KUT DISC - Aluminum Oxide

Diameter	Arbor Hole	Grit Size	Max. RPM	Standard Pack	Item Number
4-1/2"	7/8"	36	13,000	25	59403

Do not use TRIM-KUT discs in temperatures lower than 48° fahrenheit. Store at 50% relative humidity.



59403

### P TRIM-KUT ADAPTERS

Description	For Use With	Standard Pack	Item Number
1/4" Mandrel	3" TRIM-KUT Discs	25	59327
3/8"-24 UNF Adapter	3" TRIM-KUT Discs	25	59326
Adapting Nuts	4-1/2" TRIM-KUT Discs	1	56485
Spanner Wrench	Item No. 56485 only	1	56496



59327

59326



56485

56496



## NOTE

If you are using a blending disc or TRIM-KUT Disc, ask our Application Engineering Department if Weiler's BobCat Abrasive Flap Discs can enhance your productivity. BobCats dramatically outperform blending and TRIM-KUT Discs by reducing changeovers and providing consistently high cut rates and extended life. See page 37 for more information.

Key:

**P** Performance line  
Industrial Grade

**V** Value line  
Professional Grade

COATED ABRASIVES

NON-WOVEN ABRASIVES

POWER BRUSHES

NYLON BRUSHES

PACKAGED ITEMS

MAINTENANCE

# COATED ABRASIVE FLAP WHEELS



Weiler's abrasive flap wheels are designed with a solid hub construction that enables wheels to be rated at higher RPMs and provide more aggressive cutting action and increased productivity. They provide perfect balance leading to smooth, chatter-free finishing.

## Applications

- Internal diameter cleaning
- Finishing metal surfaces
- Deburring machined parts
- Cleaning and reconditioning pipe threads
- Polishing, blending & finishing
- Prepping surface for painting or plating
- Edge blending



Removing burrs from the inside diameter of a cut tube.

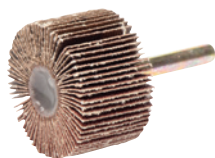

52010



52027

## P Tiger Mounted Flap Wheels - 1/4" Stem - Aluminum Oxide

A premium line designed to provide long life. Ideal for medium to high production environments.



Diameter	Width	Grit Size	Max. RPM	Standard Pack	Item Number
1"	1"	60	30,000	10	52003
		80			52004
		120			52005
1-1/2"	1"	60	25,000	10	52009
		80			52010
		120			52011
2"	1/2"	60	25,000	10	52366
		80			52367
2"	1"	60	25,000	10	52015
		80			52016
		120			52017
2-1/2"	1"	60	23,000	10	52486
		80			52487
3"	1/2"	60	23,000	10	52024
		80			52025
3"	1"	60	23,000	10	52027
		80			52028 ■
		120			52029

■ Packaged product available. See pages 131-141 for details.



52621

## P Tiger Mounted Flap Wheels - 1/4"-20 Threaded Stem - Aluminum Oxide

A premium line designed to provide long life. Ideal for medium to high production environments.



Diameter	Width	Grit Size	Max. RPM	Standard Pack	Item Number
1"	1"	60	30,000	10	52601
		80			52603
		120			52605
2"	1"	60	25,000	10	52611
		80			52613
3"	1"	60	20,000	10	52621
		80			52623

## P DRIVE ARBOR - For 1/4"-20 Mounted Flap Wheels



07756

Thread Size	Adapted Size	Standard Pack	Item Number
1/4"-20	1/4"	5	07756

## NOTE

- Drive arbor is used individually and must be ordered individually.
- Drive arbor is to be used with Weiler flap wheels only.
- Stems must be fully chucked before using and should not be run above the maximum RPM listed.

Key:

**P** Performance line  
Industrial Grade

**V** Value line  
Professional Grade



**P** TIGER® UNMOUNTED FLAP WHEELS - Aluminum Oxide



Diameter	Width	Arbor Hole	Grit Size	Max. RPM	Standard Pack	Item Number
6"	1"	1"	60	6,000	5	53286
			80			53287
6"	2"	1"	60	5,700	3	53326
			80			53327



53286

**P** METAL ADAPTERS - For Unmounted Flap Wheels. Used in pairs and priced per pair.

Wheel Arbor Hole Size	Adapted Arbor Hole Size	Standard Pack	Item Number
1"	1/2"	1	03833
	5/8"		03834
	3/4"		03835



03834

# WOLVERINE™

Formerly Branded Vortec Pro®

## GREAT VALUE AT THE RIGHT PRICE

Wolverine Flap Wheels offer a high cut rate at a cost-effective price. The smart option for use in medium production environments.

### APPLICATIONS

- Internal diameter cleaning
- Finishing metal surfaces
- Deburring machined parts
- Cleaning and reconditioning pipe threads
- Polishing, blending & finishing
- Prepping surface for painting or plating
- Edge blending

**V** WOLVERINE 1/4" STEM MOUNTED FLAP WHEELS

Provide fast cutting action at a value price. Ideal for low to medium production environments.



Diameter	Width	Grit Size	Max. RPM	Standard Pack	Item Number
					Aluminum Oxide
1"	1"	60	30,000	10	30720
		80			30721
		120			30722
2"	1"	60	25,000	10	30723
		80			30724
		120			30725
3"	1"	60	23,000	10	30726
		80			30727
		120			30728



30720



30724

**V** WOLVERINE 1/4"-20 THREADED STEM MOUNTED FLAP WHEELS

Provide fast cutting action at a value price. Ideal for low to medium production environments.



Diameter	Width	Grit Size	Max. RPM	Standard Pack	Item Number
					Aluminum Oxide
1"	1"	60	30,000	10	30745
		80			30746
2"	1"	60	25,000	10	30737
		80			30738
3"	1"	60	20,000	10	30735
		80			30736



30735

# COATED ABRASIVE SHOP ROLLS



Polishing the O.D. of a part turning in a lathe.

Weiler's Shop Rolls are resin over resin bonded - providing a stronger, heat and moisture resistant bond that better utilizes the abrasive grains. The cotton cloth provides a tougher, durable backing for longer life. J-flex cloth provides a higher degree of flexibility to conform to contoured parts.

## APPLICATIONS

- Off-hand polishing of metal surfaces
- Off-hand deburring
- General purpose machine shop use
- Cleaning stock that is being turned in a lathe



65204

## **P** SHOP ROLLS - Aluminum Oxide - 50 Yards. One roll per box.

Roll Width	Grit Size	Standard Pack	Item Number
1"	50	1	65204
	60		65205
	80		65206
	100		65207
	120		65208
	150		65209
	180		65210
	240		65212
	320		65213
1-1/2"	60	1	65218
	80		65219
	100		65220
	120		65221
	150		65222
	180		65223
	240		65225
	320		65226
	2"		60
80		65232	
100		65233	
120		65234	
150		65235	
180		65236	
240		65238	
320		65239	

## NOTE

Use light machine oil with shop rolls as a lubricant for finer finishes and quicker cut.

Key:

**P** Performance line  
Industrial Grade

**V** Value line  
Professional Grade



# NON-WOVEN ABRASIVES

## FINEST AT THE FINISH

Non-woven abrasive products can be used in a broad range of surface-conditioning applications from cleaning and finishing to deburring and light blending. Unlike bonded and coated abrasives, they cannot be used for applications requiring heavy stock removal such as grinding and weld blending.

Non-Woven Abrasives Overview .....	41
Unitized Wheels .....	41
Surface Conditioning Discs .....	42
Hand Pads .....	43
Flap Wheels .....	43



# SELECTING THE RIGHT PRODUCT

The various grades of non-woven products produce scratch patterns that can be compared to those produced by coated abrasive products. However, their pliable nature results in a softer, less pronounced scratch-line pattern. The strength of these products is producing decorative finishes ranging from satin to near-mirror polish.

Denser non-woven products are suitable for applications requiring light stock removal such as removing large, well-attached burrs and blending minor tool marks and imperfections.

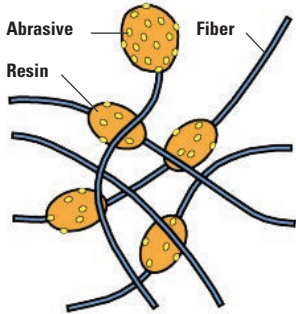

All non-woven products are fabricated from base materials that are composed of a random "web" of nylon fibers that have been bonded together with synthetic resins and impregnated with abrasive grains. Although these materials vary in fiber density, their three dimensional nature results in specialty abrasive products that are pliable, conformable to the work surface, and limited in their ability to remove base stock.

Non-woven products resist loading and perform consistently as new, fresh abrasive grains are exposed as the nylon fibers wear away from the product during use. Non-woven abrasives can be used either wet or dry on a range of materials including ferrous and non-ferrous metals, ceramics, plastics, composites, and wood. Non-woven products are designed for use where stock removal is not required. Non-wovens begin where coated abrasives leave off.

Grade	Grit Range
Ultra Fine	600
Very Fine	240-360
Fine	180-220
Medium	100-150
Coarse	50-80

## UNITIZED WHEELS



55512



55541

**P** **UNITIZED WHEELS** - Designed for use on die grinders and are ideal for a variety of cleaning, finishing, deburring and edge blending applications.



Diameter	Face Width	Arbor Hole	Grain	Grade	Max. RPM	Standard Pack	Item Number
<b>Series 2 - Cleaning &amp; Finishing - Hardness: Soft</b>							
3"	1/4"	1/4"	Aluminum Oxide	Fine	12,000	10	55512
	1/4"		Silicon Carbide	Fine			55513
<b>Series 6 - Deburring - Hardness: Medium/Hard</b>							
1"	1"	3/16"	Aluminum Oxide	Fine	30,000	10	55531
3"	1/4"	1/4"	Aluminum Oxide	Fine	18,000		54492
	1/2"		Aluminum Oxide	Fine			55530
<b>Series 8 - HD Deburring &amp; Polishing - Hardness: Hard (Heavy-Duty)</b>							
1"	1"	3/16"	Aluminum Oxide	Medium	30,000	10	55543
2"	1/8"	1/4"	Aluminum Oxide	Coarse	22,000	10	55545
3"	1/8"	1/4"		Coarse	18,000	10	55546
	1/4"			Medium			55541
	1/2"			Medium			55542

## MANDRELS



56489

Stem Diameter	For Wheel Diameter	For Wheel Thickness	Standard Pack	Item Number
1/4"	2" - 3"	1/2"	1	07761
	1"	1"	1	07764
	2" - 3"	1/8" - 1/4"	10	56489



# INTERLEAF FLAP WHEELS

Interleaf Flap Wheels provide a combination of non-woven and coated abrasive material to produce a very conformable product compared to a standard coated abrasive flap wheel. They are designed to be a finishing and surface blending tool as compared to a material-removing coated abrasive flap wheel. They are ideal for producing satin or decorative finishes on irregular or contoured surfaces.

## APPLICATIONS

- General decorative finishing
- Applying satin finishes
- Producing antique finishes
- Final sandings
- Soft metal finishing
- Removing oxides from precious metals
- Fine burr removal

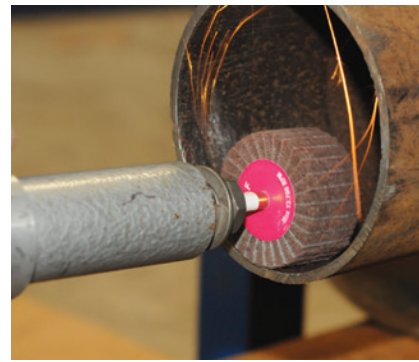

Deburring the I.D. of a steel pipe with an interleaf flap wheel.

## P STEM-MOUNTED INTERLEAF FLAP WHEELS - Aluminum Oxide

Diameter	Face Width	Grit Size	Stem Size	Max. RPM	Standard Pack	Item Number
2"	1"	120	1/4"	13,700	10	54500
		180				54501
		320				54502
3"	1"	120	1/4"	8,600	5	54506
		180				54507
		320				54508
3"	2"	120	1/4"	8,600	5	54509
		180				54510
		320				54511



54500

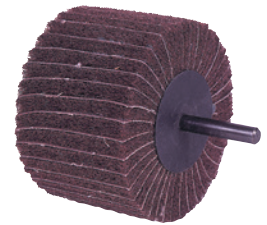

54510

COATED ABRASIVES

NON-WOVEN ABRASIVES

# HAND PADS

### Industrial Grade:

- Producing satin finishes on aluminum and stainless steel
- Light deburring
- Surface preparation
- Blending light scratches

### Commercial Grade:

- Cleaning and removing stains from stainless steel
- Removing rust, corrosion and oxidation



Polishing a rail axle journal with a non-woven hand pad.

## P HAND PADS - For cleaning and conditioning surfaces by hand. Unlike steel wool, hand pads are non-metallic, and do not produce "after-rust" on work surfaces. Hand pads can be used in wet applications.

Size	Grain	Grade	Description	Standard Pack	Item Number
<b>Industrial Grade</b>					
6" x 9"	Silicon Carbide	Ultra Fine	Finishing (Grey)	60	51434
6" x 9"	Aluminum Oxide	Medium	Economy General Purpose (Maroon)	60	51460
6" x 9"	Aluminum Oxide	Med/ Coarse	General Purpose (Maroon)	60	51444
6" x 9"	Aluminum Oxide	Heavy-Duty	Heavy-Duty (Tan)	40	51454
<b>Commercial Grade</b>					
6" x 9"	Aluminum Oxide	Fine	Economy (Green)	400	51456
6" x 9"	Aluminum Oxide	Medium	Standard-Duty (Green)	60	51457
6" x 9"	Aluminum Oxide	Heavy-Duty	Heavy-Duty (Green) 20% thicker than Standard Duty	60	51458



51457

51460

POWER BRUSHES

NYLON BRUSHES

PACKAGED ITEMS

MAINTENANCE

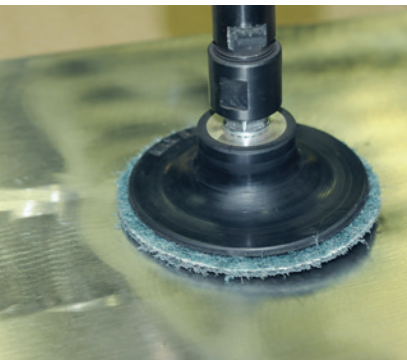

# SURFACE CONDITIONING DISCS

Surface Conditioning Discs have an open construction, scrim reinforcement and a superior resin system. These features minimize loading, heat build-up, fraying of disc edges, grain shedding and extend disc life, providing superior performance.

## APPLICATIONS

- Light deburring
- Surface preparation
- Blending light scratches
- Removing rust, corrosion and oxidation
- Cleaning and removing stains from stainless steel
- Producing satin finishes on aluminum and stainless steel

Finishing the surface for a stainless steel part for the food service industry.



51532



51533



51552

## P TYPE R HUB STYLE DISCS - General Purpose

Compatible with 3M Roloc™ back-up pads.



Diameter	Grade	Standard Pack	Item Number
2"	Very Fine (Blue)	50	51530
	Medium (Maroon)		51531
	Coarse (Brown)		51532
3"	Very Fine (Blue)	25	51533
	Medium (Maroon)		51534
	Coarse (Brown)		51535

## TYPE R HUB STYLE BACK-UP PADS - 1/4" Stem

Diameter	Max. RPM	Standard Pack	Item Number
2"	30,000	1	51551
3"	20,000	1	51552

Do not exceed maximum RPM of back-up pad.

## P HOOK & LOOP STYLE DISCS



51508



51578

Diameter	Grade	Standard Pack	Item Number
3"	Very Fine (Blue)	25	51506
	Medium (Maroon)		51507
	Coarse (Brown)		51508
4-1/2"	Very Fine (Blue)	10	51512
	Medium (Maroon)		51513
	Coarse (Brown)		51514
5"	Very Fine (Blue)	10	51515
	Medium (Maroon)		51516
	Coarse (Brown)		51517
7"	Very Fine (Blue)	10	51521
	Medium (Maroon)		51522
	Coarse (Brown)		51523

## HOOK & LOOP STYLE BACK-UP PADS

Diameter	Arbor Hole or Stem Size	Max. RPM	Standard Pack	Item Number
3"	1/4" Stem	18,000	1	51562
4-1/2"	5/8" -11 Arbor	13,000	1	51569
5"	5/8" -11 Arbor	10,000	1	51575
7"	5/8" -11 Arbor	6,000	1	51578





# POWER BRUSHES

## CHOOSE QUALITY

Superior construction, the highest quality materials, state of the art manufacturing, and exacting quality standards deliver the most consistent brush performance. Each Weiler brush is designed to provide the best performance at the lowest cost-of-use.

That's why we re-engineered our 4" stringer bead brush to deliver MAXimum impact, letting the wire do the work. Our beefed up Roughneck® Max brush delivers up to twice the life. Combine that with the hardest, strongest wire and an improved knot design to MAXimize cleaning power and you have a brush that you can trust when your name is on the line.

Technical Information.....	54-62
Knot Wire Wheels.....	63-67
Weld Cleaning Brushes.....	68-69
Crimped Wire Wheels.....	70-77
Nylon & Tampico Wheels.....	78
Cup Brushes.....	79-81
Stem-Mounted End Brushes.....	82-85
Crosshole Deburring Brushes.....	86
Power & Hand Tube Brushes.....	87-91
Miniature Brushes.....	92-93
Non-Sparking Brushes.....	94-95
Strip Brushes.....	96-99
Wide Face Brushes.....	100-101



# SOLUTIONS SHOWCASE

## TUBE END DEBURRING

**Problem:** Structural tubing is fabricated into an abundance of different forms. In order to facilitate safer handling and proper fit, the ends of the tubing must frequently be deburred.

**Solution:** Wide face crimped wire wheel brushes are an extremely effective solution for tube end deburring. Brushes can deburr the OD and ID of tubing at an extremely high rate and produce a media-cost-per-part of considerably less than \$0.01 per part.

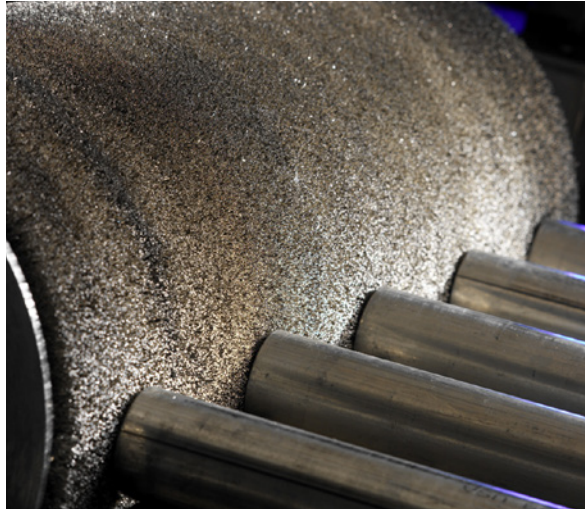

## GEAR DEBURRING

**Problem:** Power transmission components like gears cannot function properly when burrs prevent correct engagement. Further, burrs that become detached from gears can become lodged in critical transmission components causing premature wear and potential failure.

**Solution:** Knot wire wheel brushes with surface speed in excess of 6,000 SFPM are an excellent solution for deburring gears prior to heat treatment. The high energy filament tips are able to separate burrs from base material and produce a uniform edge break, which protects the edge of the gear.

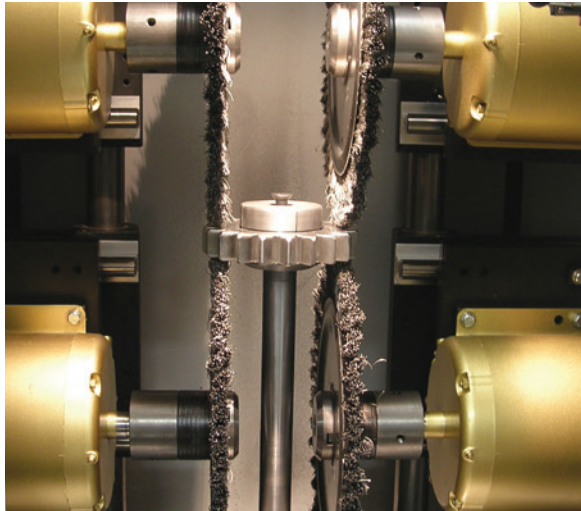

Photos courtesy of On-Line Services.

## REMOVAL OF MILL SCALE

**Problem:** Mill processing of steel often involves heat treating and oil quenching operations that produce an adherent scale, which must be removed prior to joining or finishing operations.

**Solution:** Wire brushes are capable of quickly cleaning material to white metal and producing varying degrees of surface roughening to promote adhesion. Brushing operations are often preferred over blasting and chemical processes that generate an expensive waste stream and can be costly to operate and maintain.

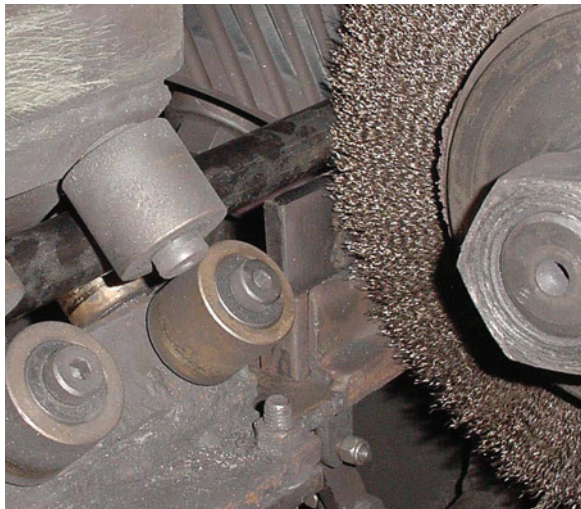



## INTER-PASS PIPELINE WELD CLEANING

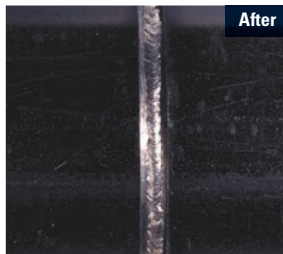
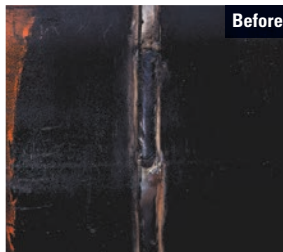
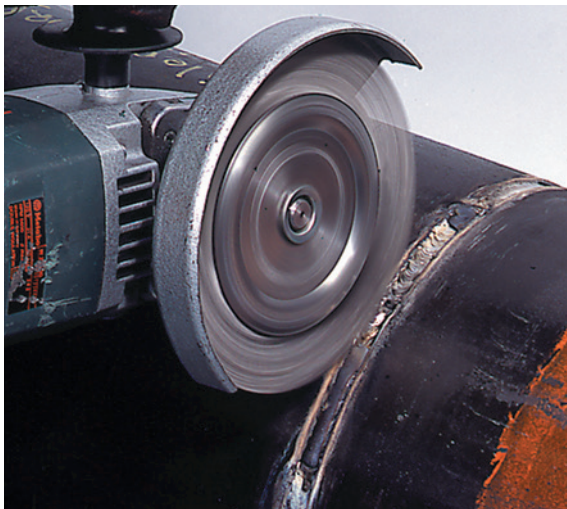

**Problem:** To prevent voids and inclusions when welding multi-pass joints, the surface of each bead must be completely cleaned of slag and other residuals. Performing inter-pass weld cleaning as quickly and as thoroughly as possible is critical to avoiding costly repair work and delays.

**Solution:** Weiler's Roughneck® and Dually® stringer bead wheels have been engineered to maximize efficiency and minimize costs and are the preferred choice of welders' helpers on the pipeline. From hot pass to cap pass, these premium weld cleaning brushes excel at quickly and thoroughly removing slag, spatter, and oxidation without damaging the filler material.

## CLEANING THREADED CONNECTIONS

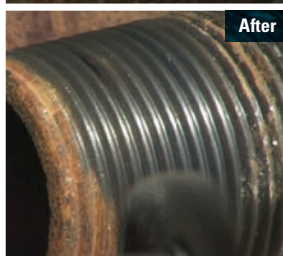
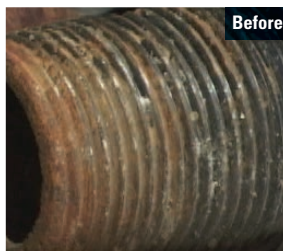

**Problem:** The box ends of drill string and other oilfield tubular goods are examples of connections that must be periodically cleaned without altering the geometry of the threads. Abrasive products all remove base material to some extent and are capable of damaging threads, resulting in unreliable connections and the risk of potential failures.

**Solution:** The conformability and impact action of small diameter crimped wire wheels make them ideal tools for cleaning threads without fear of damage. When used on a high-speed die grinder, these radial wheel brushes quickly remove residual dope as well as rust, corrosion and scale from male or female thread ends.

## REMOVAL OF EXCESS MOLDED RUBBER

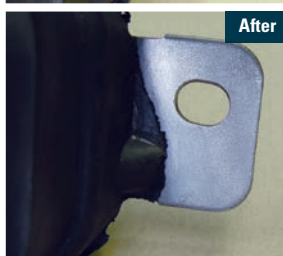

**Problem:** Mechanical rubber components such as motor mounts are produced through a process that commonly leaves flash and excess rubber on critical surfaces. In order for the component to function properly, this unwanted material must be removed.

**Solution:** The non-loading nature of wire brushes makes them the best available solution in the marketplace for removal of rubber from targeted surfaces. This solution can be implemented off-hand or using automated equipment.

# SELECTING THE RIGHT BRUSH

## SELECTION BY TOOL

	Crimped Wheels	Knot Wheels	Crimped Cups	Knot Cups	Crimped Stem-Mtd. Wheels	Knot Stem-Mtd. Wheels	Crimped Stem-Mtd. End	Knot Stem-Mtd. End	Encapsulated Brushes	Power & Hand Tube Brushes	Mini Brushes
Right Angle Grinder	✓	✓	✓	✓					✓		
Straight Grinder	✓	✓			✓	✓	✓	✓	✓		
Die Grinder	✓	✓			✓	✓	✓	✓	✓		
Corded/Cordless Hand Drill					✓	✓	✓	✓		✓	
High Speed Pencil Grinder											✓
Bench/Pedestal Grinder	✓	✓							✓		
Drill Press					✓	✓	✓	✓		✓	
CNC/Milling/ Automatic Machine	✓	✓	✓	✓	✓	✓	✓	✓	✓	✓	

## WIRE SIZE

To maximize brush life and reduce costs, always use the finest wire that will accomplish the job without requiring excessive applied pressure or engagement with the brush face.

Wire	Coarse		Medium to Coarse		Medium		Fine		Very Fine	
Gauge #	20	24	25	30	33	34	35	38	43	47
Dia. in Inches	.035	.023	.020	.014	.0118	.0104	.0095	.008	.006	.005
Dia. in Millimeters	0,89	0,58	0,51	0,36	0,30	0,26	0,24	0,20	0,15	0,13

Wire sizes in decimals of an inch are shown in all tables throughout this catalog. American Steel Wire Equivalent Gauge (Formerly Washburn & Moen)

### LARGE DIAMETER WIRE

- Aggressive brushing action
- Fatigues and breaks more quickly

### SMALL DIAMETER WIRE

- Resists fatigue and breakage
- Less aggressive
- Flexible brushing action

## CRIMPED VS. KNOT WIRE

### CRIMPED WIRE BRUSHES:



- Wire is crimped to allow individual filaments to support each other.
- Provide flexibility for light/medium duty applications.
- Use on parts that could be damaged by the impact of a knot brush.
- Use for a broad range of applications.

### KNOT WIRE BRUSHES:



- Straight wire filaments that are twisted as a single unit like a piece of cable or wire rope.
- Provide less flexibility and more aggressive brushing action in heavy-duty applications.
- Use on parts requiring high-impact action.
- Use to remove large burrs and heavy contamination, such as multiple layers of rust, scale, paint or oxides.

## KNOT TWIST CONFIGURATIONS



### STANDARD

Provides some flexibility for use on irregular surfaces. Sharp wire tips make this knot aggressive right from the start.



### HURRICANE®

Provides smoother operation but sacrifices much of the cleaning action.



### CABLE

Provides very aggressive brushing action. Sharp wire tips make this knot aggressive right from the start.



### STRINGER BEAD

High-impact action, primarily for weld cleaning. Sharp wire tips make this knot aggressive right from the start.



# TRIM LENGTH & FILL DENSITY

To maximize brush life and reduce costs, always use the shortest trim, highest density brush that will adequately conform to the surface or part edges.

## LONG TRIM, LOW DENSITY BRUSHES

- Flexibility that is ideal for applications such as cleaning surfaces that are somewhat irregular
- Lower fill density can result in shorter brush life and less consistent performance in production environments.

## SHORT TRIM, HIGH DENSITY BRUSHES

- Less flexible and faster action requires less applied pressure
- Consistent performance and longer life

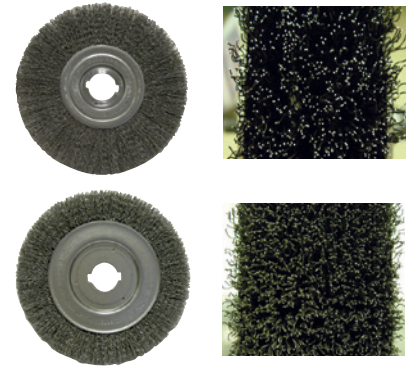

# POLYFLEX® ENCAPSULATED

These brushes are suitable for extremely demanding applications that do not require a high degree of conformability. They are especially well-suited for users with the following types of requirements:

**Extreme brushing pressure** - Encapsulation protects wires from over-flexing and extends brush life relative to conventional knot and crimped wire brushes.

**Severe cleaning operations** - Encapsulation holds the wire tips rigidly in place and creates the most aggressive brushing action that can be achieved with a wire brush.

## BURGUNDY (STANDARD)



General purpose elastomer; suitable for most manufacturing applications.

## ORANGE (HEAVY-DUTY)



A more heavy-duty elastomer than burgundy; used for more demanding applications.

## BLACK (EXTRA HEAVY-DUTY)



A heat stabilized elastomer that does not wear easily; used primarily for cleaning welds.

# ARBOR HOLE VARIATIONS

## FOR WEILER PERFORMANCE LINE WHEELS

If an arbor hole size other than the size listed in the product table is required, change the last digit of the Item Number as indicated in the Table.

Arbor Hole Diameter	Arbor Hole Features	Change Last Digit of Item # To:
1/2"-3/8"	Plastic Snap-Out Adapter	4
5/8"-1/2"	Plastic Snap-Out Adapter	5
5/8"-11 UNC	Threaded Nut (6", 7" & 8" Wheels Only)	6
5/8"	3", 4" & 6" Wheels Only	7
3/4"	—	8
7/8"	—	0 - 11
1"	1/4"*x 1/8"+ double keyway	0 - 12
1-1/4"	5/16"*x 5/32"+ double keyway	9
1-1/2"	3/8"*x 3/16"+ double keyway	0 - 13
1-3/4"	3/8"*x 3/16"+ double keyway	0 - 16
2"	1/2"*x 1/4"+ double keyway	0 - 14
2-1/4"	3/4"*x 3/8"+ double keyway	0 - 17
2-1/2"	1/2"*x 1/4"+ double keyway	0 - 15

\* Width of keyway

+ Depth of keyway

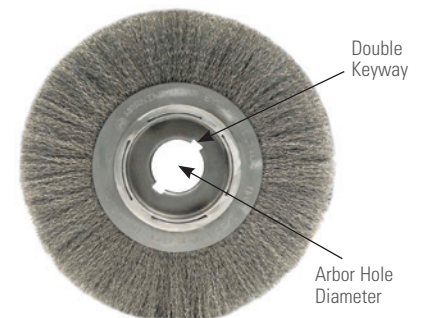

**Example:** Item Number 01228 has a listed, standard size arbor hole of 3/4". If an 1-1/4" arbor hole is desired, drop the 8 from 01228 and add 9. The Item Number becomes 01229. If a 2" arbor hole is desired, drop the 8 from 01228 and add 0-14. The Item Number becomes 01220-14.

# PRODUCT ADVANTAGES

## PRODUCT LINE STRUCTURE

### **P** PERFORMANCE LINE (INDUSTRIAL GRADE)

Engineered and manufactured to maximize performance and minimize operating costs in the most demanding surface conditioning applications. The use of superior construction, the highest quality materials and the most stringent manufacturing processes deliver the lowest cost-of-use and most consistent performance in heavy production environments.

### **V** VALUE LINE (PROFESSIONAL GRADE)

Weiler's value line is manufactured using similar product construction and the same exacting standards as other Weiler power brushes, but engineered to provide cost-effective use in less demanding environments. Wolverine™ brushes (Formerly Vortec Pro®) are an economical choice for the construction trades, low volume production shops and light duty industrial MRO use.

## OPERATIONAL ADVANTAGES

### POWER BRUSHES DO NOT REMOVE BASE MATERIAL

- The impact action of the wire tips of a rotating brush behave in the same manner as the media in a blasting operation and they have the same ability to separate surface contaminants without damaging the substrate.
- Due to its compliant nature, a power brush is the ideal tool for removing burrs and blending sharp edges without changing overall part dimensions after sawing, cutting, grinding and machining operations.

Grinding Wheel



Wire Wheel



### POWER BRUSHES DO NOT LOAD

Unlike bonded, coated and non-woven abrasive products, power brushes will not load when used on softer materials or when removing paint or similar coatings from a harder surface. Because a power brush consists of a collection of individual wire filaments, there is no place for debris to accumulate and prevent the sharp wire tips from striking the work.

Resin Fiber Disc



Wheel Brush



### POWER BRUSHES ARE SELF-SHARPENING

As a power brush is used, the wire tips will naturally tend to wear to a point due to contact with the working surface. It is possible to take advantage of this self-sharpening action by periodically switching the mounting position of wheel brushes to maintain their speed and effectiveness.

## WEILER SUPERIOR CONSTRUCTION



### WEILER'S SOLID RING CONSTRUCTION

Our crimped wire brushes are constructed using solid rings to retain the fill material and our manufacturing process results in an even, consistent distribution of wire strands around the entire brush diameter. This ensures that our crimped wire products run smoother and last longer than the competition – even in the toughest applications.



### WEILER'S INDIVIDUAL KNOT HOLE CONSTRUCTION

Weiler's knot wheels are constructed with an internal steel plate that has equally spaced individual holes around the perimeter. Wire is inserted through each hole and twisted into a knot. Each hole has precisely the same wire count, thereby assuring perfect balance. This eliminates vibration, reduces operator fatigue and increases brush life.

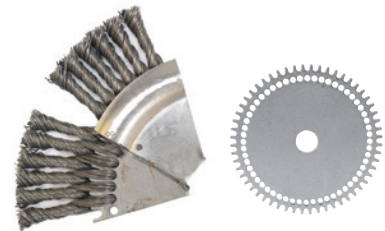

### WEILER'S ROUGHNECK® WELD CLEANING BRUSH CONSTRUCTION

Each knot is twisted through its own hole and locked into an individual sprocket tooth. This prevents the knots from moving, providing a stronger striking action on the work surface, longer brush life and less operator fatigue. This results in the most aggressive weld cleaning in the market with the lowest cost-per-piece brushed.



# PRODUCT CHARACTERISTICS

## WHEEL BRUSH

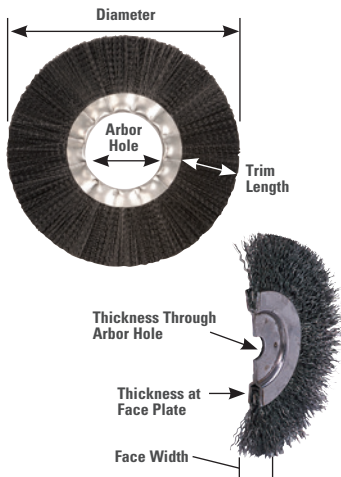

## CUP BRUSH

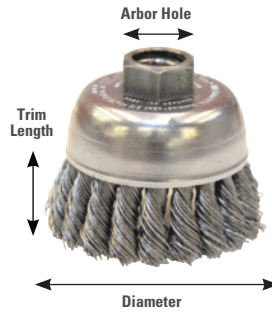

## END BRUSH



## TUBE BRUSH

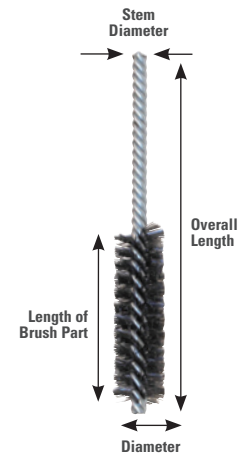

## FILL MATERIALS



**Steel Wire** - Carbon steel wire is the most durable power brush fill material for metalworking and heavy-duty cleaning applications. **Weiler industrial grade brushes** utilize heat treated, high tensile steel wire that has been drawn to the most exacting industry standards for superior fatigue resistance and aggressive brushing action. **Vortec Pro® professional grade brushes** utilize more cost-effective grades of steel wire to deliver reliable performance in less demanding applications.



**Stainless Steel Wire** - Stainless steel wire is only recommended when brushing corrosion-resistant or non-ferrous metals such as stainless or aluminum or when the brush is being used in a wet environment. Stainless steel wire is not any more durable or aggressive than the highest grades of steel wire. All Weiler stainless steel brushes are manufactured with Type 302 stainless wire, but select items are also available with Type 316 wire by special order.



**Non-Ferrous Wire** - Brass, bronze and aluminum wire are available in assorted Weiler industrial grade power brush items. These non-ferrous materials will not generate a spark in use, but they lack the durability of carbon steel and stainless steel wire. Due to their soft brushing action, these materials may also be used in special applications such as decorative finishing.



**Animal Hair** - Natural hair bristle is used primarily in miniature power brushes for scratch-free cleaning and polishing. Depending on the animal species and type of hair, this fill material can range from relatively stiff to relatively soft, making it suitable for a variety of applications from removing dust from optical lenses to buffing precious metals using abrasive compounds.



**Vegetable Fiber** - Tampico, a natural fiber produced from the Mexican agave plant, is a common natural fill material used in wet scrubbing and cleaning applications as well as buffing and polishing metals. It is heat, alkali and acid resistant. Its natural color is off-white but it may be dyed or bleached.



**Synthetic** - Nylon is typically the most durable synthetic bristle material for use in power brushes and can be used in a variety of applications due to its flexibility, high fatigue strength and resistance to abrasion, heat, acids and alkali. Polypropylene is less durable and used primarily in strip brushes.

## STAINLESS STEEL BRUSHES

Weiler's stainless steel wire brushes are manufactured using wire drawn from Type 302 stainless steel. Although 302 stainless is typically a non-magnetic material, it is important to remember that the amount of cold-working that it experiences during the wire-drawing process causes it to become magnetic. For this reason, proper storage and handling of stainless steel brushes is critical to prevent cross-contamination and "after rust" issues. Type 302 is widely used in the manufacture of power brushes for its relative durability

and aggressive action as well as for its austenitic properties that insure the corrosion resistance of the materials on which it is applied. The use of a different grade of stainless steel wire is typically required in critical weld preparation and cleaning applications, but it will not address "after rust" and other cross-contamination issues. To insure the corrosion resistance of any stainless steel surface after brushing, passivating it with a 10-20% solution of nitric acid is recommended.

# WORK SAFER WITH PROPER BRUSH USAGE

Weiler products are designed and manufactured to the strictest standards to ensure the highest level of quality and safety. But safety doesn't stop there; raising awareness of basic safety practices and thinking about safety before the job starts — and after the job is complete — can help curb accidents and injuries in the shop. That's why Weiler offers customers a Safety Training Program based on the **SPOT (Speed & Size, Pressure, Orientation, Time)** methodology to help promote safe and proper product usage.



Deploying our **SPOT Safety Training Program** in your facility helps improve safety, regardless of your application or work environment.

For **SPOT Safety Training** contact your Weiler representative.

## SPEED & SIZE

- Power brushes, operate most effectively when the speed and pressure of the operation are properly matched to the demands of the application. In most operations, the highest speed and lightest pressure will ensure the fastest brushing action and longest brush life.
- Increasing brush speed increases the face hardness and brushing action; therefore, a fine wire brush rotating at a higher speed will often produce the same results as a coarser wire brush rotating at a slower speed. Finer wire operating at a higher speed is generally preferred and will provide a longer brush life.
- MSFS - Maximum Safe Free Speed (RPM) is the maximum speed at which the brushes may be used safely but is not necessarily the optimum speed for a given application. Operating speed should be determined by the application. When running a wire

brush, a rule of thumb is to run it a "mile a minute" or a minimum of 5,000 Surface Feet Per Minute (SFPM). However, never exceed the Maximum Safe Free Speed of the brush.

- Make sure spindle size and motor of machine are large enough to accommodate the diameter of brush to be used (see table on pg. 61).



Match the RPM rating of the power brush to the tool being used. The RPM of the tool should never exceed the RPM of the power brush.

## RECOMMENDED SURFACE SPEEDS FOR BRUSHING APPLICATIONS

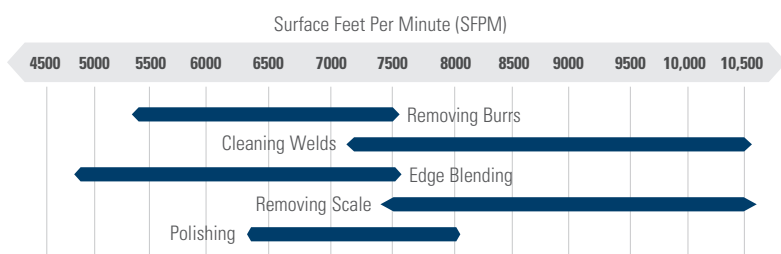

$$SFPM = \frac{\pi \text{ Dia. (Inches)} \times RPM}{12}$$

## SURFACE SPEEDS (PERIPHERAL SPEED IN FT./MIN.)

RPM	Diameter (Inches)							
	2	3	4	6	8	10	12	15
1000	525	785	1,050	1,575	2,100	2,625	3,150	3,925
1500	785	1,175	1,575	2,350	3,150	3,925	4,725	5,900
1750	915	1,375	1,850	2,750	3,650	4,550	5,500	6,800
2500	1,300	1,950	2,625	3,925	5,250	6,550	7,850	9,825
3000	1,575	2,350	3,125	4,725	6,275	7,850	9,425	11,775
3450	1,800	2,700	3,600	5,400	7,200	9,000	11,000	13,500
4000	2,100	3,150	4,175	6,275	8,375	10,475	—	—
6000	3,125	4,700	6,275	9,425	—	—	—	—
10,000	5,250	7,850	10,500	—	—	—	—	—
15,000	7,850	11,775	15,750	—	—	—	—	—
20,000	10,450	15,700	20,950	—	—	—	—	—

**Example:** A 6" diameter wheel running at 3,450 RPM has a surface speed of 5,400 SFPM.



## MINIMUM RECOMMENDED SPINDLE DIAMETER (From ANSI Standard B165.1)

Outside Dia. of Wheel Brush	Maximum Face Width of Wheel Brush	Minimum Outside Dia. of Spindle (Shaft)
2"	1/4"	1/4"
3"	3/4"	1/4"
3" (heavy-duty)	1"	3/8"
4"	1"	3/8"
6"	1-1/4"	1/2"
8"	1-1/4"	5/8"
10"	2"	3/4"
12"	3"	1"
14"	3"	1-1/4"
15"	3"	2"
16"	3"	2"

Note: These diameters are based on the wheel brush being mounted next to the supported end of the shaft rather than the unsupported end in order to minimize overhang.

## RECOMMENDED MOTOR SIZES (Based on 1" Brush Face)

Brush Diameter	Motor Size	RPM
4"	1/4 HP	3,450
6"	1/2 HP	3,450
8"	3/4 HP	3,450
10"	1 HP	1,750
12"	1 HP	1,750
15"	1-1/2 HP	1,750

## PRESSURE

Avoid excessive pressure when using a wire brush. Excessive pressure causes over-bending of the filaments and heat build-up resulting in filament breakage, rapid dulling and reduced brush life.

### INSTEAD OF GREATER PRESSURE, TRY:

- A brush with more aggressive action (increase filament diameter, decrease trim length, different brush type, i.e.; knot type instead of crimped type).
- Higher surface speed (increase RPM or brush diameter)

Never exceed the recommended Maximum Safe Free Speed or RPM rating of the brush.



**Correct**  
Wire Tips Doing the Work

**Incorrect**  
Excessive Pressure Causes Wire Breakage

## ORIENTATION

### WORKING ANGLE BY BRUSH TYPE

Never stray more than 15° from the suggested working angles of the brush configurations below.

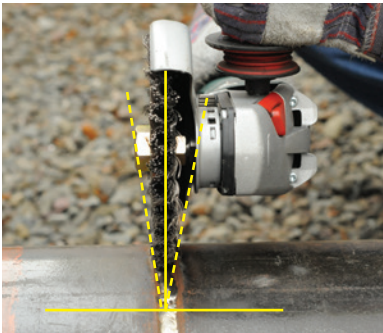

**WHEEL +/- 15°**



**CUP +/- 15°**



**BEVEL +/- 15°**

## TIME

Reduce the time it takes to get the job done by choosing the most appropriate product configuration. (See page 56 for product selection information.)

### SELF-SHARPENING OF WIRE WHEEL BRUSHES

When using wire wheel brushes without nuts, periodically reverse the direction of rotation to take advantage of the self-sharpening action that will result. Remove the brush from the spindle, flip the wire brush 180° and remount the brush securely.



**Remove**



**Flip 180°**

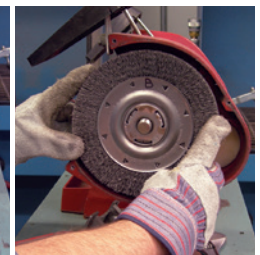

**Remount Securely**

# POWER BRUSH TROUBLESHOOTING GUIDE

There are many variables in power brush applications. If the power brush you are using does not accomplish the desired results, select a solution from the suggestions below for your specific application or call Weiler's Application Engineering Hotline at 888-299-2777.

Problem	Recommended Solutions
Brush works too fast	<ul style="list-style-type: none"> <li>• Select a brush with longer filaments and/or lower fill density</li> <li>• Select a brush with a smaller diameter wire</li> <li>• Select a brush with a narrower face and/or lower fill density</li> <li>• Select a brush with a smaller outside diameter</li> <li>• Operate the brush at a slower RPM</li> </ul>
Brush works too slowly	<ul style="list-style-type: none"> <li>• Select a brush with shorter filaments and/or higher fill density</li> <li>• Select a brush with a larger diameter wire</li> <li>• Select a brush with a wider face and/or higher fill density</li> <li>• Select a brush with a larger outside diameter</li> <li>• Operate the brush at a faster RPM</li> </ul>
Brushing action rolls or peens the burr over instead of removing burr	<ul style="list-style-type: none"> <li>• Select a brush with a larger diameter wire</li> <li>• Select a brush with shorter filaments and/or higher fill density</li> <li>• Operate the brush at a faster RPM</li> <li>• Replace the crimped wire brush with a knot wire brush</li> </ul>
Finer final finish required	<ul style="list-style-type: none"> <li>• Select a brush with longer filaments</li> <li>• Select a brush with a smaller diameter wire</li> <li>• Operate the brush at a higher RPM</li> <li>• Replace the wire brush with a nylon abrasive brush (Nylox<sub>®</sub>)</li> </ul>
Coarser final finish required	<ul style="list-style-type: none"> <li>• Select a brush with shorter filaments</li> <li>• Select a brush with a larger diameter wire</li> <li>• Operate the brush at a slower RPM</li> </ul>
Non-uniform brushing action	<ul style="list-style-type: none"> <li>• Select a brush with longer filaments</li> <li>• Select a brush with a larger diameter wire</li> <li>• Automate the operation to reduce human variables</li> </ul>
Filaments break off	<ul style="list-style-type: none"> <li>• Reduce applied pressure or engagement</li> <li>• Select a brush with a smaller diameter wire</li> <li>• Select a brush with a lower fill density</li> </ul>
Short brush life	<ul style="list-style-type: none"> <li>• Reduce applied pressure or engagement</li> <li>• Select a brush with a smaller diameter wire</li> <li>• Select a brush with a higher fill density</li> </ul>

## NEED HELP?

Call our Application Engineering Hotline at 888-299-APPS (2777). If the problem is too complex to be solved over the phone, we will determine if an evaluation should be conducted at our in-house lab or your facility. Either way, Weiler will provide the most cost-effective solution for your specific application.



# KNOT WIRE WHEELS WITH ARBOR HOLE

Knot wire wheels with arbor holes are intended for use on straight grinders and stationary machines such as bench or pedestal grinders and buffing lathes. Featuring Weiler's individual knot hole construction, these radial brushes are available in heat-treated steel, Type 302 stainless steel, and bronze wire for use in a wide variety of applications.

## APPLICATIONS

- Removing rust, scale and heavy corrosion
- Surface roughening and preparation
- Coating removal
- Removing excess molded rubber or plastic
- Heavy deburring



Removing rubber coating from a hydraulic hose.

**P** **STANDARD TWIST WHEELS** provide heavy-duty brushing action with some flexibility; ideal for demanding cleaning applications on somewhat irregular surfaces.



Dia.	Wire Size	Arbor Hole	No. of Knots	Face Width	Trim Length	Max. AH Avail.	Thickness at Face Plates	Max. RPM	Std. Pack	Item Number	
										Steel	Stainless
3"	.0118	1/2"-3/8"	20	3/8"	5/8"	1/2"	7/16"	25,000	10	08004	08254
	.014									08014 ■	08264 ■
	.020									08024 ▲	08274
4"	.0118	1/2"-3/8"	24	1/2"	7/8"	1/2"	7/16"	20,000	10	08034	08284
	.014									08044 ■	08294
	.020									08064	08314
4"	.014	5/8"-1/2"	24	1/2"	7/8"	7/8"	7/16"	20,000	10	08045	—
	.0118									08075	08325
6"	.014	5/8"-1/2"	24	1/2"	1-3/8"	1-1/4"	9/16"	9,000	10	08085 ■	—
	.016									08095	08345
	.023									08105	—
	.016									08975	—
7"	.014	5/8"	24	5/8"	1-7/8"	1-1/4"	9/16"	9,000	2	08835	—
	.0118									08125	08375
8"	.014	5/8"	38	5/8"	1-5/8"	2"	1/2"	6,000	2	08135	—
	.016									08145	08395
	.023									08155	—
	.014									08138	—
10"	.014	3/4"	52	3/4"	1-3/4"	2-1/2"	3/4"	4,500	2	08178	—
	.014									08179	—
10"	.016	1-1/4"★	52	3/4"	1-3/4"	2-1/2"	3/4"	4,500	2	08189	—
	.014									08209	—
12"	.014	1-1/4"★	52	3/4"	2-3/4"	2-1/2"	11/16"	3,600	1	08219	—
	.016									08200-14	—
12"	.014	2"◆	52	3/4"	2-3/4"	2-1/2"	11/16"	3,600	1	09719	—
	.020									09870	—
12"	.023	2"◆	66	3/4"	2-1/4"	3"	13/16"	5,000	2	08249	—
	.016									08249	—

★ 5/16" x 5/32" Double Keyway

◆ 1/2" x 1/4" Double Keyway

▲ Available in non-sparking bronze wire, see page 94-95 for details.

■ Packaged product available. See pages 131-141 for details.



08014



08085



08189

COATED ABRASIVES

NON-WOVEN ABRASIVES

POWER BRUSHES

NYLON BRUSHES

PACKAGED ITEMS

MAINTENANCE

**V** **WOLVERINE™ STANDARD TWIST WHEELS** provide aggressive brushing action for general-purpose surface cleaning applications.



Dia.	Wire Size	Arbor Hole	No. of Knots	Face Width	Trim Length	Max. AH Avail.	Thickness at Face Plates	Max. RPM	Std. Pack	Item Number	
										Steel	Stainless
3"	.014	1/2"-3/8"	20	3/8"	3/8"	1/2"	7/16"	25,000	10	36290	—
4"	.014	1/2"-3/8"	20	5/8"	7/8"	1/2"	9/16"	20,000	10	36226 ■	—
										24	—
6"	.014	5/8"-1/2"	24	1/2"	1-1/4"	5/8"	9/16"	9,000	10	36227 ■	—
8"	.014	5/8"	34	9/16"	1-5/8"	5/8"	1/2"	6,000	2	36228 ■	—
										.023	36279

■ Packaged product available. See pages 131-141 for details.



36228

## NOTE

If a different arbor hole is required (than listed in the tables) refer to Arbor Hole Table shown on Pg. 57.

**P STANDARD TWIST WHEELS - High Density & Extra High Density** - Engineered for maximum performance in production applications; for use on automated equipment such as dedicated gear deburring machines.



08339



09020

Diameter	Wire Size	Arbor Hole	Face Width	Trim Length	Thickness at Face Plates	Max. RPM	Standard Pack	Item Number Steel
<b>80 KNOTS</b>								
14"	.0118	1-1/4"★	3/4"	2-1/2"	5/8"	5,000	2	08309
	.0118	2"◆						08300
	.014	1-1/4"★						08319
	.014	2"◆						08310
	.020	1-1/4"★						08339
	.020	2"◆						08330
15"	.0118	1-1/4"★	3/4"	3"	5/8"	5,000	2	09969
	.0118	2"◆						09960
	.014	1-1/4"★						09989
	.014	2"◆						09980
	.020	1-1/4"★						09999
	.020	2"◆						09990
<b>90 KNOTS</b>								
14"	.014	2"◆	3/4"	1-1/2"	5/8"	5,000	2	09020*
	.016	2"◆						09790
	.016	1-1/4"★						09799
	.020	2"◆						09800
	.020	1-1/4"★						09809
	.020	1-1/4"★						09049*
15"	.020	2"◆	3/4"	2"	5/8"	5,000	2	09840
	.020	2"◆						09080*
	.020	1-1/4"★						09089*

★ 5/16" x 5/32" Double Keyway

◆ 1/2" x 1/4" Double Keyway

\* Economy

**P STANDARD TWIST WHEELS - Two Section** - Provide heavy-duty brushing action with some flexibility; feature a double row of knotted wire for a wider brush face.



09460

Diameter	Wire Size	Arbor Hole	No. of Knots	Face Width	Trim Length	Thickness at Face Plates	Max. RPM	Standard Pack	Item Number Steel
3"	.0118	1/2"-3/8"	40	3/4"	5/8"	3/4"	22,000	5	09104
4"	.0118	1/2"-3/8"	48	3/4"	7/8"	3/4"	20,000	5	09134
6"	.0118	2"	60	7/8"	1-3/8"	7/8"	8,000	5	09160
	.016								09180
8"	.0118	2"	76	1"	1-5/8"	1"	6,000	1	09410
	.016								09430
	.023								09440
10"	.0118	2"	104	1-1/4"	1-3/4"	1-1/4"	4,500	1	09460
	.016								09480
	.023								09490
12"	.0118	2"	104	1-1/4"	2-3/4"	1-1/4"	3,600	1	09510
	.016								09530
	.023								09540

See Metal Adapters on page 72 for brushes with 2" arbor holes.

**P STANDARD TWIST WHEELS - Four Section** - Featuring four rows of knotted wire; for use in automated cleaning processes such as removing light mill scale from metal rod and wire.



94000

Diameter	Wire Size	Arbor Hole	No. of Knots	Face Width	Trim Length	Thickness at Face Plates	Max. RPM	Standard Pack	Item Number Steel
12"	.0118	2"	208	2"	2-3/4"	1-3/4"	3,600	1	94098
	.014								94000

See Metal Adapters on page 72 for brushes with 2" arbor holes.



**P** **CABLE TWIST WHEELS** provide maximum brushing action with minimal flexibility; ideal for demanding cleaning and coating removal applications on relatively smooth surfaces.



Dia.	Wire Size	Arbor Hole	No. of Knots	Face Width	Trim Length	Max. AH Avail.	Thickness at Face Plates	Max. RPM	Std. Pack	Item Number	
										Steel	Stainless
4"	.020	1/2"-3/8"	24	1/4"	7/8"	1/2"	7/16"	20,000	10	08534 ■	—
6"	.023	5/8"-1/2"	24	3/8"	1-3/8"	1-1/4"	9/16"	9,000	10	08565 ■	08695*
8"	.023	5/8"	38	1/2"	1-5/8"	2"	1/2"	6,000	2	08615	—
10"	.023	3/4"	52	1/2"	1-3/4"	2-1/2"	3/4"	4,500	2	08878	—
		1-1/4"★								08879	—
12"	.023	1-1/4"★	52	7/16"	2-3/4"	3"	3/4"	3,600	2	09379	—

If a different arbor hole is required (than listed) refer to the Arbor Hole Variations Table on page 57. ★ 5/16" x 5/32" Double Keyway \*Standard Pack 2  
 ■ Packaged product available. See pages 131-141 for details.



08534

**P** **CABLE TWIST WHEEL - Four Section** - Featuring four rows of tightly knotted wire; for use in demanding automated applications such as cleaning the OD of drill pipe and other oilfield tubular goods.

Dia.	Wire Size	Arbor Hole	No. of Knots	Face Width	Trim Length	Max. AH Avail.	Thickness at Face Plates	Max. RPM	Std. Pack	Item Number
10"	.023	2"	208	1-3/4"	1-3/4"	2"	1-7/8"	4,500	1	94008



94008

**P** **JOINT & CRACK CLEANING WHEELS** feature heavy-duty construction and an extra long trim length for cleaning expansion joints and cracks in concrete and asphalt.



Dia.	Wire Size	Arbor Hole	No. of Knots	Face Width	Trim Length	Thickness at Face Plates	Max. RPM	Standard Pack	Item Number
10"	.035	1" with two drive holes*	38	3/8"	2-5/8"	1/2"	5,000	2	94199
12"	.035	1" with two drive holes*	38	3/8"	3-5/8"	1/2"	5,000	2	94224
12"	.035	1" with two drive holes*	52	3/8"	2-3/4"	3/4"	6,000	2	94026

\*Drive holes are 3/8" diameter with 1/4" x 1/8" double keyway.

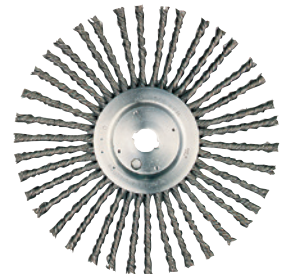

94224

**ADAPTER** for mounting Joint & Crack Cleaning Wheels onto a 20mm arbor.

For Brush Arbor Hole Size	Adapted Arbor Hole Size	Standard Pack	Item Number
1"	20mm	10	04455



04455

*Cleaning a crack on an airport runway with a joint & crack cleaning brush prior to filling.*



**NOTE**

If a different arbor hole is required (than listed in the tables) refer to Arbor Hole Table shown on Pg. 57.

Key:

**P** Performance line Industrial Grade

**V** Value line Professional Grade

WHY WEILER  
 BONDED ABRASIVES  
 COATED ABRASIVES  
 NON-WOVEN ABRASIVES  
 POWER BRUSHES  
 NYLON BRUSHES  
 PACKAGED ITEMS  
 MAINTENANCE

# KNOT WIRE WHEELS WITH NUT



Cleaning a corner weld with a bevel brush.

Knot wire wheels with a threaded nut are intended for use primarily on small and large right angle grinders. Featuring Weiler's individual knot hole construction, these radial brushes are available in heat-treated steel, Type 302 stainless steel and bronze wire for use in a wide variety of applications.

## APPLICATIONS

- Removing powder-coating, epoxy-based paints, and rubberized coatings
- Weld preparation and cleaning
- Cleaning scale and heavy corrosion
- Removing heavy burrs from large pieces after cutting

**P** **STANDARD TWIST WHEELS** provide heavy-duty brushing action with some flexibility; ideal for deburring and demanding cleaning applications on somewhat irregular surfaces.



13106

Dia.	Wire Size	Arbor Hole	No. of Knots	Face Width	Trim Length	Max. RPM	Std. Pack	Item Number	
								Steel	Stainless
3"	.014	3/8"-24 UNF	20	3/8"	5/8"	25,000	5	13201	13208
4"	.014	M10 x 1.25	24	1/2"	7/8"	20,000	5	13100	13107
		M10 x 1.50						13101	13108
		M14 x 2.0						13102	13109
		3/8"-24 UNF						13103	13110
		1/2"-13 UNC						13105	—
5/8"-11 UNC	13106 ■	13113 ■							
4"	.020	M10 x 1.25	24	1/2"	7/8"	20,000	5	13114	—
		M10 x 1.50						13115	—
		M14 x 2.0						13116	—
		3/8"-24 UNF						13117	—
		1/2"-13 UNC						13119	—
		5/8"-11 UNC						13120 ▲ ■	—
6"	.016 .023	5/8"-11 UNC	24	1/2"	1-3/8"	9,000	2 5	—	08346
								08106	—

■ Packaged product available. See pages 131-141 for details.

▲ Available in non-sparking bronze wire, see page 94-95 for details.



36224

**V** **WOLVERINE™ STANDARD TWIST WHEELS** provide an aggressive brushing action for general purpose deburring, cleaning, and surface preparation applications.



Dia.	Wire Size	Arbor Hole	No. of Knots	Face Width	Trim Length	Max. RPM	Std. Pack	Item Number	
								Steel	Stainless
4"	.014	5/8"-11 UNC	20	1/2"	7/8"	20,000	5	36212 ■	36213 ■
		M10 x 1.25						36215 ■	—
		M10 x 1.50						36216 ■	—
		M14 x 2.0						36217 ■	—
6"	.025	5/8"-11 UNC	24	3/4"	1-1/4"	11,000	10	36224 ■	—

■ Packaged product available. See pages 131-141 for details.



13266

**P** **CABLE TWIST WHEELS** provide maximum brushing action with minimal flexibility; ideal for demanding cleaning and surface preparation applications on relatively smooth surfaces.



Dia.	Wire Size	Arbor Hole	No. of Knots	Face Width	Trim Length	Max. RPM	Std. Pack	Item Number	
								Steel	Stainless
4"	.020	M10 x 1.25	24	1/4"	7/8"	20,000	5	13261	—
		M10 x 1.50						—	13272
		5/8"-11 UNC						13266 ■	13276

■ Packaged product available. See pages 131-141 for details.

**V** **WOLVERINE CABLE TWIST WHEELS** provide the most aggressive brushing action for general purpose cleaning and surface preparation applications.



Dia.	Wire Size	Arbor Hole	No. of Knots	Face Width	Trim Length	Max. RPM	Std. Pack	Item Number	
								Steel	Stainless
4"	.020	5/8"-11 UNC	20	1/4"	7/8"	20,000	5	36255 ■	—
		M10 x 1.50						36257	—
		M10 x 1.25						36258	—

■ Packaged product available. See pages 131-141 for details.



**P** **STANDARD TWIST BEVEL BRUSHES** are saucer-shaped radial wheels that provide a heavy-duty brushing action with some flexibility; ideal for cleaning fillet welds and into corners.



Diameter	Wire Size	Arbor Hole	No. of Knots	Face Width	Trim Length	Max. RPM	Std. Pack	Item Number	
								Steel	Stainless
4"	.014	M10 x 1.25	20	3/8"	3/4"	12,500	1	13401	—
		M10 x 1.50						13402	—
		5/8"-11 UNC						13406	13416
4"	.020	M14 x 2.0	20	3/8"	3/4"	12,500	1	13423	—
		5/8"-11 UNC						13426	13436
4-1/2"	.014	5/8"-11 UNC	20	3/8"	1"	12,500	1	13456	13466
4-1/2"	.020	5/8"-11 UNC	20	3/8"	1"	12,500	1	13476	13486



13456

**P** **THREADED ADAPTERS** for mounting brushes with a 5/8"-11 UNC nut to other threaded spindles.

Fixed Thread Size	Adapted Thread Size	Standard Pack	Item Number
5/8"-11 UNC	M10 x 1.25	10	07771 ■
5/8"-11 UNC	M10 x 1.50	10	07772 ■
5/8"-11 UNC	3/8"-16 UNC	10	07769
5/8"-11 UNC	3/8"-24 UNF	10	07746



07771

■ Packaged product available. See pages 131-141 for details.

## KNOT WIRE WHEELS WITH STEM

Knot wire wheels with a permanently attached 1/4" stem or shank are primarily intended for use on high-speed die grinders. Although they can also be mounted onto a drill, the speed and power of that tool will limit the effectiveness of the brush. Featuring Weiler's individual knot hole construction, these radial wheels are available in heat-treated steel and Type 302 stainless steel wire.

### APPLICATIONS

- Removing powder-coating, epoxy-based paints, and rubberized coatings
- Weld preparation and cleaning
- Cleaning scale and heavy corrosion
- Removing heavy burrs from large pieces after cutting

**P** **STANDARD TWIST WHEELS 1/4" Stem** - Provide heavy-duty brushing action with some flexibility; ideal for deburring and demanding cleaning applications on somewhat irregular surfaces.

Diameter	Wire Size	No. of Knots	Face Width	Trim Length	Max. RPM	Standard Pack	Item Number	
							Steel	Stainless
3-1/4"	.0118	20	3/8"	5/8"	25,000	5	17680	—
	.014						17681 ■	17684
	.020						17682	—
4"	.0118	24	1/2"	7/8"	20,000	5	17686	—
	.014						17687 ■	17691
	.020						17689	—



17684

■ Packaged product available. See pages 131-141 for details.

*"We get a competitive edge with Weiler because their prices are competitive but they last far longer."*

- **Jim Martin**, Vice President, Karnel Incorporated



Key:

**P** Performance line  
Industrial Grade

**V** Value line  
Professional Grade

WHY WEILER

BONDED ABRASIVES

COATED ABRASIVES

NON-WOVEN ABRASIVES

POWER BRUSHES

NYLON BRUSHES

PACKAGED ITEMS

MAINTENANCE

# WELD CLEANING BRUSHES

Weiler's stringer bead wheels are the most effective weld cleaning tools for the most demanding users. Our premium weld cleaning brushes are manufactured to the most stringent quality standards, utilizing the highest quality wire available. The twist puts all the sharp tips at the end of the knots, making them the fastest, most aggressive weld cleaning tools on the market.



UP TO  
**2X**  
THE LIFE

## ROUGHNECK MAX

MADE IN  
**USA**

**NEW!** Roughneck Max wheels have been re-engineered to MAXimize life, efficiency and consistency. But that is only a small part of what makes this brush better...

- **Smooth & Responsive** — Improved feel and comfort during use makes brush operation effortless
- **No Long Wire Breakage** — Stronger, sharper wire delivers consistency and performance you can count on
- **Cleans 40% Faster** — Unmatched cleaning power compared to competitors
- **Less Force Required** — The operator can apply less pressure to clean, letting the wire do the work

**NEW!**

**P**

**ROUGHNECK MAX STRINGER BEAD WHEELS** deliver unmatched weld cleaning performance by maximizing life, efficiency and consistency. The 4" brushes are recommended for cleaning root pass welds, surface prep and other cleaning applications.



Diameter	Wire Size	Arbor Hole	No. of Knots	Face Width	Trim Length	Thickness at Face Plates	Max. RPM	Std. Pack	Item Number	
									Steel	Stainless
4"	.020	5/8"-11 UNC	32	3/16"	7/8"	7/16"	20,000	5	13131 ■	13138 ■

■ Packaged product available. See pages 131-141 for details.



13131

## ROUGHNECK

MADE IN  
**USA**

**P**

**ROUGHNECK STRINGER BEAD WHEELS** are the standard for high-performance weld cleaning brushes. Narrow face brushes are suitable for cleaning root and hot passes and reaching into corners; wider face wheels can be used for cleaning filler and cap passes as well as for other surface prep and cleaning applications.



Diameter	Wire Size	Arbor Hole	No. of Knots	Face Width	Trim Length	Thickness at Face Plates	Max. RPM	Std. Pack	Item Number	
									Steel	Stainless

### Root Pass Brushes

4"	.020	1/2"-3/8" M10 x 1.25 M10 x 1.50 M14 x 2.0 3/8"-24 UNF 1/2"-13 UNC	32	3/16"	7/8"	7/16"	20,000	5	13124	08954*
									13125 ■	13132
									13126	—
									13127	13134
									13128	13135
									13130	13137
4-1/2"	.020	5/8"-11 UNC 7/8"	38	3/16"	13/16"	3/8"	15,000	5	13232	13238
									13234	13249
5"	.020	5/8"-11 UNC 7/8"	38	3/16"	7/8"	3/8"	12,500	5	08756	08806
									08750	—
6"	.020	5/8"-11 UNC	48	3/16"	1-1/8"	3/8"	12,500	10	08766†	—
					1-3/8"	3/8"			—	08786†•
					1-1/8"	7/16"			09400 ■	09500
7"	.020	5/8"-11 UNC	56	3/16"	1-1/8"	7/16"	9,000	10	09000 ■	09200
			76						—	09100

### Filler Pass Brushes

5"	.023	5/8"-11 UNC	24	1/2"	7/8"	3/8"	12,500	5	09856	09866
6"	.023	5/8"-1/2"	24	1/2"	1-3/8"	9/16"	12,500	10	08775	—
		5/8"-11 UNC	24		1-3/8"	9/16"			08776 ■	08796•
		5/8"-11 UNC	30		1-1/4"	5/8"			08916	08926•
		5/8"-11 UNC	30		1-3/8"	1/2"			09386	09396•

† Light Duty

• Standard Pack 5

\* Standard Pack 10

■ Packaged product available. See pages 131-141 for details.



09000

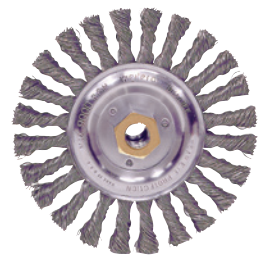

08776

### NOTE

If a different arbor hole is required (than listed in the tables) refer to Threaded Adapter Chart shown on Pg. 67.



# THE DUALLY®



MADE IN USA

- **Maximum Cleaning Action** — Featuring a knot twist with the most aggressive cutting action, the new dual-hex nut makes it easier for the user to regularly switch mounting position and keep the brush running at peak performance.
- **Long Wheel Life** — Utilizing the highest quality heat-treated Steel wire and construction that virtually eliminates knot movement, the Dually delivers smooth operation and long life for the lowest cleaning costs in demanding multi-pass welding applications such as pipeline construction.
- **Improved User Safety** — The one-piece, dual-hex nut is designed to provide adequate tool clearance so there is no need to remove the guard from the grinder in order to change the position of the wheel.



Removing weld slag before the next weld pass.

**P** **DUALLY STRINGER BEAD WHEELS** feature a dual-hex nut design that simplifies periodic flipping of the wheel for maximum cleaning action, long life, and safer use.



Diameter	Wire Size	Arbor Hole	No. of Knots	Face Width	Trim Length	Thickness at Face Plates	Max. RPM	Standard Pack	Item Number	
									Steel	Stainless
<b>Root Pass Brushes</b>										
4-1/2"	.020	5/8"-11 UNC	38	3/16"	13/16"	3/8"	15,000	5	79801	79811
5"	.020	5/8"-11 UNC	38	3/16"	7/8"	3/8"	12,500	5	79802	79812
6"	.020	5/8"-11 UNC	56	3/16"	1-1/8"	7/16"	12,500	5	79805	79815
7"	.020	5/8"-11 UNC	56	3/16"	1-1/8"	7/16"	9,000	5	79800	79810
<b>Filler Pass Brushes</b>										
5"	.023	5/8"-11 UNC	24	1/2"	7/8"	3/8"	12,500	5	79803	79813
6"	.023	5/8"-11 UNC	30	1/2"	1-1/4"	5/8"	12,500	5	79804	79814



79802

**P** **POLYFLEX™ ENCAPSULATED WELD CLEANING WHEELS** Black Elastomer\* Feature a heat-stabilized encapsulation that gradually wears away to expose a consistent short trim for higher aggression, controlled brushing action, and longer life; suitable for cleaning hot welds.



Diameter	Wire Size	Arbor Hole	No. of Knots	Face Width	Trim Length	Thickness at Face Plates	Max. RPM	Standard Pack	Item Number	
									Steel	
4"	.020	5/8"-11 UNC	32	3/16"	7/8"	7/16"	20,000	5	35800	▲
6"	.014	5/8"-11 UNC	—	3/16"	1-7/16"	3/8"	9,000	5	35206	
7"	.020	5/8"-11 UNC	56	3/16"	1-1/8"	7/16"	9,000	10	35600	▲
	.014		—		1-15/16"				3/8"	5

▲ Stringer Bead Wheels \* See Elastomer Color Code Chart on page 57 for more information.



35800

# WOLVERINE™

Previously known as Vortec Pro®, Wolverine wheels offer professional grade quality and performance at a great value. Re-engineered, these 32 knot wheels deliver 20% MORE life while maintaining aggressive cleaning power for weld cleaning applications.

**NEW!**

**V** **WOLVERINE™ STRINGER BEAD WHEELS** have upgraded to 32 knots to deliver 20% longer life. The 4" wheels are manufactured using similar product construction and to the same exacting standards as other Weiler weld cleaning brushes; they have been engineered for cost-effective use in less demanding cleaning applications.

Diameter	Wire Size	Arbor Hole	No. of Knots	Face Width	Trim Length	Thickness at Face Plates	Max. RPM	Standard Pack	Item Number	
									Steel	Stainless
4"	.020	5/8"-11 UNC	32	3/16"	7/8"	7/16"	20,000	5	36218	■

■ Packaged product available. See pages 131-141 for details.



36218

**V** **WOLVERINE STRINGER BEAD WHEELS** are manufactured using similar product construction and to the same exacting standards as other Weiler weld cleaning brushes; they have been engineered for cost-effective use in less demanding applications.



Dia.	Wire Size	Wire Type	Arbor Hole	No. of Knots	Face Width	Trim Length	Max. RPM	Item Number	
								Steel	Stainless
5"	.020	Stainless	5/8"-11 UNC	38	3/16"	7/8"	12,500	36295	36296
6"	.020	Carbon	5/8"-11 UNC	48	1/4"	1-1/4"	12,500	36225	—
		Carbon		38	3/16"	1-3/8"		36307†	—
7"	.020	Carbon	5/8"-11 UNC	56	3/16"	1-1/8"	9,000	36297	—

† Light Duty



36297

COATED ABRASIVES

NON-WOVEN ABRASIVES

POWER BRUSHES

NYLON BRUSHES

PACKAGED ITEMS

MAINTENANCE

# CRIMPED WIRE WHEELS WITH ARBOR HOLE



Removing heat discoloration from a stainless steel canister.

Crimped Wire Wheels with Arbor Hole are intended for use on straight grinders and stationary machines such as bench or pedestal grinders and buffing lathes. Featuring Weiler's solid ring construction, these radial brushes are available in heat-treated steel, Type 302 stainless steel and brass wire for use in a wide variety of applications.

## APPLICATIONS

- Removing rust and light corrosion
- Paint removal and surface cleaning
- Decorative finishing
- Removing heat discoloration
- Light deburring

**P** **CRIMPED WIRE WHEELS - Narrow Face** - provide a flexible brushing action and consistent performance for demanding light-duty cleaning and deburring applications.



00184



01238

Dia.	Wire Size	Arbor Hole	Face Width	Trim Length	Max. AH Avail.	Thickness at Face Plates	Max. RPM	Std. Pack	Item Number	
									Steel	Stainless
3"	.006	1/2"-3/8"	7/16"	1/2"	3/4"	7/16"	12,500	2	00204	00244
	.008								00214	-
	.0118								00234	00264
	.014								00274	-
4"	.006	1/2"-3/8"	1/2"	7/8"	3/4"	7/16"	12,500	2	00104	00154
	.006								00105	-
	.008	5/8"-1/2"	1/2"-3/8"	00114	-					
	.0095	00124			-					
	.0118	00134			00184					
	.0118	00135			-					
.014	5/8"-1/2"	00144	-							
6"	.006	5/8"-1/2"	3/4"	1-7/16"	1-1/4"	7/16"	6,000	10	01035 ▲	01675*
	.008	01045							-	
	.008	1-1/4" ★	5/8"-1/2"	01049	-					
	.0104	01055			01695*					
	.0118	01065 ▲			01705*					
	.014	01075 ■			-					
.0118	3/4"	3/4"	1-7/16"	1-1/4"	7/16"	6,000	10	01068	-	
8"	.006	5/8"	3/4"	2-1/16"	1-1/4"	1/2"	6,000	2	01135	01775
	.008								01145	-
	.0104	3/4"	2-1/16"	1-1/4"	1/2"	6,000	2	01155	01795	
	.0118							01165	01805	
	.014							01175 ■	-	
	.006							01138	-	
.008	01148	-								
.0104	01158	-								
.0118	01168	-								
.014	01178	-								
8"	.0118	1-1/4" ★	3/4"	2-1/16"	1-1/4"	1/2"	6,000	2	-	01809
	.014	-	-	-	-	-	-	-	01179	-
10"	.006	3/4"	3/4"	2-1/2"	2"	5/8"	4,000	2	01228	-
	.0104								01238	-
	.0118	1"	•	01248	-					
	.014				01258	01898				
	.014				01250-12	-				
	.014				01259	-				
12"	.006	1-1/4" ★	3/4"	2-15/16"	2-1/2"	1/2"	3,000	2	01299	01939
	.0104	01309	01949							
	.0118	01319	-							
	.014	01329	-							
12"	.014	2" ◆	3/4"	2-15/16"	2-1/2"	1/2"	3,000	2	01320-14	-
	.0118	1-1/4" ★	3/4"	4-7/16"	2-1/2"	1/2"	3,000	2	01339	-
.014	-	-	-	-	-	-	-	01349	-	

## NOTE

If a different arbor hole is required (than listed in the tables) refer to Arbor Hole Table shown on Pg. 57.

◆ 1/2" x 1/4" Double Keyway

★ 5/16" x 5/32" Double Keyway

• 1/4" x 1/8" Double Keyway

▲ Available in non-sparking brass wire, see page 94-95 for details.

\* Standard Pack 2

■ Packaged product available. See pages 131-141 for details.



**V** **WOLVERINE™ CRIMPED WIRE WHEELS - Narrow Face** - provide a flexible brushing action and cost-effective performance in general purpose cleaning and deburring applications.



Dia.	Wire Size	Arbor Hole	Face Width	Trim Length	Max. AH Avail.	Max.RPM	Std. Pack	Item Number	
								Steel	Stainless
4"	.014	1/2"-3/8"	1/2"	3/4"	1/2"	6,000	2	36262 ■	–
6"	.014	5/8"-1/2"	3/4"	1-1/4"	5/8"	6,000	2	36200 ■	36201 ■
8"	.014	5/8"	3/4"	2"	5/8"	6,000	2	36205 ■	–

■ Packaged product available. See pages 131-141 for details.



36205

**P** **POLYFLEX™ ENCAPSULATED CRIMPED WIRE WHEELS** feature an encapsulation that gradually wears away to expose a consistent short trim for higher aggression, controlled brushing action, and longer life.



Dia.	Wire Size	Arbor Hole	Face Width	Trim Length	Max. AH Avail.	Thickness at Face Plates	Max. RPM	Standard Pack	Item Number
									Steel
<b>Burgundy Elastomer*</b>									
4"	.0095	1/2"-3/8"	3/8"	7/8"	3/4"	7/16"	6,000	2	35084
6"	.0104	5/8"-1/2"	1/2"	1-7/16"	1-1/4"	7/16"	6,000	2	35105
	.014								35117
8"	.014	5/8"	1/2"	2-1/16"	1-1/2"	1/2"	6,000	2	35135
<b>Orange Elastomer* - Heavy-Duty</b>									
6"	.0104	5/8"-1/2"	1/2"	1-7/16"	1-1/4"	7/16"	6,000	2	35520

\* See Elastomer Color Code chart on page 57 for more information.



35105

**P** **BENCH GRINDER WHEELS** feature a shorter trim length, narrower face width, and the same durable construction as other Weiler crimped wire wheels; designed specifically for use on small bench grinders for reduced flaring and long life in a broad range of applications.



Dia.	Wire Size	Arbor Hole	Face Width	Trim Length	Max. AH Avail.	Thickness at Face Plates	Max. RPM	Standard Pack	Item Number
									Steel
6"	.006	5/8"-1/2"	1/2"	1-1/16"	1-1/4"	7/16"	6,000	10	01085
	.008								01095
	.0118								01115
	.014								01125



01115

**P** **CRIMPED WIRE WHEELS - High Density** - Feature an increased fill density for greater brushing action, more consistent performance, and longer life in the most demanding applications requiring the flexibility of a crimped wire wheel.



Dia.	Wire Size	Arbor Hole	Face Width	Trim Length	Max. AH Avail.	Thickness at Face Plates	Max. RPM	Std. Pack	Item Number	
									Steel	Stainless
4-1/4"	.0118	5/8"-1/2"	3/4"	5/8"	3/4"	9/16"	6,000	1	01501	–
	.014								01502	
6"	.008	5/8"-1/2"	3/4"	1-1/8"	1"	9/16"	6,000	1	01503	–
	.0118								01504	01508
	.014								01505	01509
	.020								01506	–
	–								–	–
7"	.014	5/8"	7/8"	1-5/8"	1"	9/16"	6,000	1	01511	–
8"	.006	5/8"	7/8"	1-1/2"	1-1/4"	11/16"	4,500	1	01512	–
	.0104								01513	–
	.0118								01514	–
	.014								01515	–
10"	.0118	3/4"	1"	2-1/2"	1-1/4"	11/16"	4,500	2	01517	–
	.014								01518	–



01515

WHY WEILER

BONDED ABRASIVES

COATED ABRASIVES

NON-WOVEN ABRASIVES

POWER BRUSHES

NYLON BRUSHES

PACKAGED ITEMS

MAINTENANCE



06080



06150

**P** **CRIMPED WIRE WHEELS - Medium Face** - Provide a flexible brushing action and consistent performance for demanding light-duty cleaning and deburring applications; feature a wider face width to cover more area.



Dia.	Wire Size	Arbor Hole	Face Width	Trim Length	Thickness at Face Plates	Max. RPM	Standard Pack	Item Number	
								Steel	Stainless
4-1/2"	.0118	2"	15/16"	3/4"	7/8"	6,000	1	06020	—
6"	.006	2"	1"	1-1/8"	15/16"	6,000	1	06040	—
	.008							06050	—
	.0104							06060	06440
	.0118							06070	06450
	.014							06080	—
8"	.006	2"	1"	1-3/8"	1"	4,500	1	06090	—
	.0104							06100	—
	.0118							06110	06490
	.014							06120	—
	.020							06620	—
10"	.0118	2"◆	1-1/8"	2"	1"	3,600	1	06150	06530
	.014							06160	—
	.020							06170	—
12"	.0118	2"◆	1-1/4"	3"	1"	3,600	1	06180	—
	.014							06190	—
	.014							06200	—
	.020							06200	—

◆ 1/2" x 1/4" Double Keyway  
For arbor hole reducing adapters, see Metal Adapter Table below.



02325

**V** **WOLVERINE™ CRIMPED WIRE WHEELS - Medium Face** - Provide a flexible brushing action and cost-effective performance in general purpose cleaning and deburring applications; feature a wider face width to cover more area.



Dia.	Wire Size	Arbor Hole	Face Width	Trim Length	Thickness at Face Plates	Max. RPM	Standard Pack	Item Number	
								Steel	
6"	.014	5/8"-1/2"	5/8"	1-1/16"	1/2"	6,000	1	02325	■
			3/4"	1-7/16"	7/16"			36203	■
7"	.014	5/8"	3/4"	1-9/16"	1/2"	6,000	1	02335	■

■ Packaged product available. See pages 131-141 for details.

**P** **METAL ADAPTERS** for Medium & Wide Face Brushes. Used in pairs & priced per pair.



03809

For Brush Arbor Hole Size	Adapted Arbor Hole Size	Item Number
2"	1/2"	03809
	5/8"	03810
	3/4"	03811
	7/8"	03824
	1"	03812
	1-1/4"	03813
	1-1/2"	03814



22241

**P** **PLATER'S WIRE WHEELS** feature a longer trim length and very small diameter fill material for producing fine satin and antique finishes on non-ferrous and precious metals.



Dia.	Wire Size	Arbor Hole	Face Width	Trim Length	Number of Rows	Max. RPM	Std. Pack	Item Number	
								Brass*	
3"	.003	1/4"	1/2"	1"	2	6,000	12	22021	
4"	.004	1/4"	1"	1-1/4"	4	4,000	5	22061	
6"	.005	1/4"	1"	1-7/8"	4	3,600	1	22241	

\* Also available in carbon steel, stainless steel and nickel silver wire.



**P**

**CRIMPED WIRE WHEELS - Wide Face** - Provide a flexible brushing action and consistent performance for demanding light-duty cleaning and deburring applications; feature a wider face width to cover more area.



Dia.	Wire Size	Arbor Hole	Face Width	Trim Length	Thickness at Face Plates	Max. RPM	Standard Pack	Item Number	
								Steel	Stainless
4-1/2"	.006	2"	1-1/4"	3/4"	7/8"	6,000	1	03000	-
	.0118							03010	-
	.014							03020	-
6"	.006	2"	1-1/4"	1-1/8"	1"	6,000	1	03030	03480
	.008							03040	-
	.0104							03050	-
	.0118							03060	03510
	.014							03070	03520
7"	.0118	2"	1-1/4"	1-5/8"	1"	6,000	1	03090	-
	.014							03100	-
8"	.006	2"	1-1/2"	1-3/8"	1-3/8"	4,500	1	03110	-
	.0095							03130	-
	.0118							03140	03590
	.014							03150	-
	.020							03160	-
10"	.0104	2"	2"	1-7/8"	1-5/8"	4,000	1	03180	-
	.0118							03190	-
	.014							03200	-
	.020							03210	-
12"	.0118	2"	2"	2-7/8"	1-9/16"	3,000	1	03220	-
	.014				03230			03680	
	.020				03240			-	

For arbor hole reducing adapters, see Metal Adapter Table on page 72.



03110

**V**

**WOLVERINE CRIMPED WIRE WHEELS - Wide Face** - Provide a flexible brushing action and cost-effective performance in general purpose cleaning and deburring applications; feature a wider face width to cover more area.



Dia.	Wire Size	Arbor Hole	Face Width	Trim Length	Thickness at Face Plates	Max. RPM	Standard Pack	Item Number	
								Steel	
6"	.014	2"-5/8"-1/2"	7/8"	1-1/8"	7/8"	6,000	1	06645 ■	
								36204 ■	
7"	.014	2"-5/8"-1/2"	7/8"	1-5/8"	7/8"	6,000	1	06655 ■	
8"	.014	2"-5/8"-1/2"	1"	1-3/8"	1"	4,000	1	36206 ■	
10"	.014	2"-3/4"	1-1/8"	2"	1"	3,600	1	36265 ■	

■ Packaged product available. See pages 131-141 for details.



06655

**P**

**POLYFLEX™ ENCAPSULATED CRIMPED WIRE WHEEL - Wide Face - Burgundy\***  
**Elastomer\*** - Features an encapsulation that gradually wears away to expose a consistent short trim for higher aggression, controlled brushing action, and longer life. Wider face width covers more area.



Dia.	Wire Size	Arbor Hole	Face Width	Trim Length	Thickness at Face Plates	Max. RPM	Std. Pack	Item Number	
								Steel	
6"	.0118	2"	1"	1-1/8"	1"	6,000	1	35160	

\* See Elastomer Color Code Chart on page 57 for more information.  
 For arbor hole reducing adapters, see Metal Adapter Table on page 72.



35160

WHY WEILER  
 BONDED ABRASIVES  
 COATED ABRASIVES  
 NON-WOVEN ABRASIVES  
 POWER BRUSHES  
 NYLON BRUSHES  
 PACKAGED ITEMS  
 MAINTENANCE

# SMALL DIAMETER "COPPER CENTER" WHEELS



Removing casting flash from ductile-iron housing with an encapsulated brush.

Weiler's small diameter crimped wire wheels feature a plain arbor hole for use on a variety of portable tools and stationary machines. Featuring Weiler's solid ring construction for high-speed use, these radial brushes are available in heat-treated steel, Type 302 stainless steel, and brass wire.

## APPLICATIONS

- Removing carbon build-up and deposits
- Removing rust and light corrosion
- Cleaning and finishing ID's and recessed areas
- Cleaning boiler tubes and internal passages
- Cleaning threads
- Wire stripping
- Light deburring

**P** **SMALL DIAMETER WHEELS** provide a flexible brushing action and consistent performance for light-duty cleaning and deburring applications requiring a small wheel.



15433



15563

Dia.	Wire Size	Arbor Hole	Face Width	Trim Length	Max. RPM	Standard Pack	Item Number						
							Steel	Stainless					
1"	.003	1/4"	3/16"	1/4"	20,000	10	—	16461					
	.005						—	16471					
	.006						15071	—					
1-1/4"	.003	1/4"	1/4"	3/8"	20,000	10	15101	—					
	.006						15111	16511					
	.008						—	16521					
	.008						15732	—					
1-3/8"	.006	1/4"	1/4"	3/8"	20,000	10	15131	—					
	.008						15141	—					
	.0104						15151	—					
1-1/2"	.006	3/8"	1/4"	7/16"	20,000	10	15302 ▲	16702					
	.008						15312	16712					
	.008						15753	—					
	.0104						15322	—					
	.0118						15332	—					
	.014						15332	—					
	.014						15762	—					
2"	.003	1/4"	3/8"	3/4"	20,000	10	99307	—					
	.003	1/2"					15863	—					
	.005	1/2"					—	16833					
	.006	1/2"					15433 ▲	—					
	.008	1/2"					15443	16843					
	.0104	1/2"					15453	16853					
	.0118	1/2"-3/8"					15463 ▲	—					
	.014	1/2"-3/8"					15473	16873					
	2-1/2"	.0118					1/2"-3/8"	1/2"	3/4"	20,000	10	15513	—
		.014										15523	—
	3"	.003					1/2"	5/8"	1"	20,000	10	99551	—
.006		1/2"-3/8"	15533	16933									
.006		5/8"	15637	—									
.008		1/2"-3/8"	15543	16943									
.008		5/8"	15647	—									
.0104		1/2"	15553	—									
.0118		1/2"-3/8"	15563	16963									
.0118		5/8"	15667	—									
.014		1/2"-3/8"	15573 ▲	16973									
.014		5/8"	15677	—									
4"		.006	1/2"	1/2"	1-1/2"	20,000	10					99553	—

▲ Available in non-sparking brass wire, see page 94-95 for details.

**P**

**POLYFLEX™ ENCAPSULATED SMALL DIAMETER WHEELS -**

**Burgundy Elastomer\*** - Feature an encapsulation that gradually wears away to expose a consistent short trim for higher aggression, controlled brushing action, and longer life.



Diameter	Wire Size	Arbor Hole	Face Width	Trim Length	Max. RPM	Standard Pack	Item Number
							Steel
1-1/4"	.008	3/8"	3/16"	5/16"	20,000	10	35293
	.014						35294
2"	.0104	1/2"	1/4"	1/2"	20,000	10	35240
	.014						35070
3"	.008	1/2"	1/4"	1"	20,000	10	35808
	.0118						35250
	.014						35260

\* See Elastomer Color Code chart on page 57 for more information.



35070

**WIRE STRIPPING BRUSHES**

Used for removing insulation from electrical wire. These brushes are made to order according to the specifications needed for the specific application.

When ordering, please specify:

- Brush diameter
- Brush face width
- Arbor hole size
- Wire size

For application assistance, call our Application Engineering Hotline toll-free at: 888-299-APPS (2777)

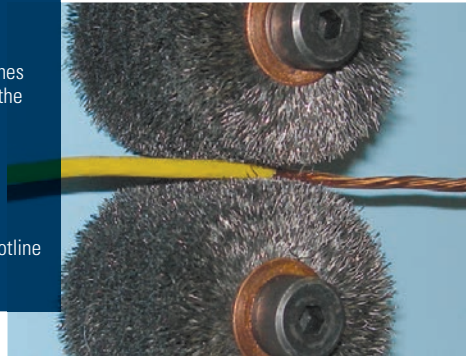

**NOTE**

- The adapters and drive arbors listed on this page are for use with small diameter wheel brushes only; do not attempt to use them with cutting or grinding wheels, buffing wheels, or any type of abrasive wheel or disc.
- Do not adapt a wheel brush for use on a shaft diameter less than that specified by ANSI B165.1 (see page 53) or exceed the maximum wheel diameter specified for a drive arbor.
- Never mount a drive arbor onto a tool that operates above the maximum RPM rating of either the arbor or the brush (whichever may be lower) and be sure that the stem of the arbor is properly secured in the collet or chuck before use.

**P**

**DRIVE ARBORS** for mounting small diameter wheels into a collet or chuck.



Arbor Dia.	Stem Dia.	Stem Length	Length of Shaft	For Brushes with a Max. Dia. of	Overall Length	Max. RPM	Standard Pack	Item Number
<b>Unthreaded Shaft</b>								
1/4"	1/4"	1-1/8"	3/16"	2"	2-1/16"	20,000	5	07723
3/8"	1/4"	1-1/8"	3/16"	4"	1-15/16"	20,000	5	07722
<b>Threaded Shaft</b>								
1/4"	1/4"	1-1/16"	1-1/8"	2"	2-9/16"	20,000	5	07725
3/8"	1/4"	3/4"	3/4"	3"	1-9/16"	25,000	5	07727
3/8"	1/4"	1"	1-1/8"	3"	2-9/16"	20,000	5	07726
1/2"	1/4"	3/4"	3/4"	3"	1-3/4"	25,000	5	07724
1/2"	1/4"	7/8"	3/4"	3"	1-11/16"	20,000	5	07721
5/8"	1/4"	3/4"	3/4"	3"	1-13/16"	25,000	5	07729



07723



07722



07727



07726



07724



07721



07729

**P**

**PLASTIC ADAPTERS** for mounting small diameter wheels onto various arbor sizes.

Fixed Arbor Hole Size	Adapted Arbor Hole Size	Standard Pack	Item Number
3/8"	1/4"	10	04403
1/2"	1/4"	10	04400
1/2"	3/8"	10	04401
5/8"	1/2"	10	04402



04401, 04402

WHY WEILER  
BONDED ABRASIVES  
COATED ABRASIVES  
NON-WOVEN ABRASIVES

POWER BRUSHES

NYLON BRUSHES

PACKAGED ITEMS

MAINTENANCE



# CRIMPED WIRE WHEELS WITH NUT OR STEM



Removing flash from a sand-cast iron engine block.

Crimped wire wheels with a threaded nut are intended for use primarily on small angle grinders. Featuring Weiler's solid ring construction, these radial brushes are available in heat-treated steel and Type 302 stainless steel wire.

## APPLICATIONS

- Removing rust and light corrosion
- Surface prep prior to welding
- Removing heat discoloration and welding residuals

**P** **CRIMPED WIRE WHEELS** provide a flexible brushing action and consistent performance for demanding light-duty cleaning and deburring applications.



13085

Dia.	Wire Size	Arbor Hole	Face Width	Trim Length	Max. RPM	Std. Pack	Item Number	
							Steel	Stainless
4"	.006	5/8"-11 UNC	1/2"	7/8"	14,000	5	—	00156
4"	.014	M14 x 2.0	1/2"	7/8"	14,000	5	13077	—
		3/8"-24 UNF					13078	—
		5/8"-11 UNC					13081	13085
4"	.014	5/8"-11 UNC	1/2"	7/8"	14,000	5	35416*	—

\* Polyflex™ encapsulated - Burgundy elastomer. See Elastomer Color Code Chart on page 57 for more information.

**V** **WOLVERINE™ CRIMPED WIRE WHEEL** provides a flexible brushing action and cost-effective performance in general purpose cleaning and deburring applications.



Diameter	Wire Size	Arbor Hole	Face Width	Trim Length	Max. RPM	Standard Pack	Item Number
							Steel
4"	.014	5/8"-11 UNC	1/2"	3/4"	14,000	5	36207

Crimped wire wheels with a permanently attached 1/4" stem or shank are primarily intended for use on high-speed die grinders. Although they can also be mounted onto a drill, the speed and power of that tool will limit the effectiveness of the brush. Featuring Weiler's solid ring construction, these radial wheels are available in heat-treated steel, Type 302 stainless steel, and brass wire.

## APPLICATIONS

- Cleaning and finishing ID's and recessed areas
- Paint removal and surface cleaning
- Cleaning threads
- Light deburring

**P** **CONFLEX BRUSHES** **Narrow Face - 1/4" Stem** - Provide a very flexible brushing action.



17616

Diameter	Wire Size	Face Width	Trim Length	Max. RPM	Standard Pack	Item Number	
						Steel	Stainless
2"	.006	3/8"	1/2"	20,000	10	17609	—
	.0118					17610 ■	17611 ■
2-1/2"	.006	3/8"	3/4"	20,000	10	17612	—
	.014					17614	—
3"	.008	1/2"	1"	20,000	10	17615 ■	—
	.0118					17616 ▲ ■	—
	.014					17617	17618 ■

■ Packaged product available. See pages 131-141 for details.

▲ Available in non-sparking brass wire, see page 94-95 for details.

**P** **POLYFLEX™ ENCAPSULATED CONFLEX BRUSHES - Burgundy Elastomer\* - 1/4" Stem** - Feature an encapsulation that gradually wears away to expose a consistent short trim for higher aggression, controlled brushing action, and longer life.



35310

Diameter	Wire Size	Face Width	Trim Length	Max. RPM	Standard Pack	Item Number
						Steel
2"	.0118	1/4"	1/2"	20,000	10	35305
3"	.008	1/4"	1"	20,000	10	35310
	.0118					35315

\* See Elastomer Color Code Chart on page 57 for more information.

**P**

**CONFLEX BRUSHES - Wide Face - 1/4" Stem** - Provide a flexible brushing action and consistent performance for demanding light-duty cleaning and deburring applications; feature a wider face width to cover more area.



Diameter	Wire Size	Face Width	Trim Length	Max. RPM	Standard Pack	Item Number	
						Steel	Stainless
1-1/4"	.006	1/2"	3/8"	20,000	10	17600	—
	.008					17601	—
1-1/2"	.006	1/2"	1/2"	20,000	10	17602	—
	.008					17603	—
	.0118					17604	—
1-3/4"	.006	1/2"	5/8"	20,000	10	17605	—
	.008					—	17608
2"	.0118	3/4"	7/16"	20,000	10	17619	—
2-1/2"	.014	3/4"	11/16"	20,000	10	17620	—
3"	.008	1"	15/16"	20,000	10	17621	17637
	.0118					—	—
	.014					17623	—



17603

**P**

**CRIMPED WIRE RADIAL WHEELS 1/4" Stem** - Feature side plates for a shorter trim length and more controlled brushing action in a stem-mounted crimped wire wheel.



Diameter	Wire Size	Face Width	Trim Length	Max. RPM	Standard Pack	Item Number	
						Steel	Stainless
1-1/2"	.006	1/4"	3/8"	20,000	10	17950	17971
	.008					17951	17972
	.0118					17952	17973
	.014					17953	—
						17954	—
2"	.006	3/8"	7/16"	20,000	10	17954	—
	.008					17955	17974
	.0118					17956	—
	.014					17957	17975
	.020					17958	—
						17959	17976
2-1/2"	.008	7/16"	9/16"	20,000	10	17959	17976
	.0118					17961	—
	.014					17962	17977
	.020					17963	—
						17964	17978
3"	.008	1/2"	13/16"	20,000	10	17964	17978
	.0118					17965	—
	.014					17966	17979
	.020					17967	—
						17968	17981
						17969	17982



17971

**V**

**WOLVERINE CRIMPED WIRE RADIAL WHEELS 1/4" Stem** - Designed to be a flexible and economic small diameter brushing tool for a broad range of general purpose applications.



Diameter	Wire Size	Face Width	Trim Length	Max. RPM	Standard Pack	Item Number	
						Steel	
1-1/2"	.0118	1/4"	3/8"	20,000	10	36208	■
2"	.014	3/8"	7/16"	20,000	10	36209	■
3"	.008	7/16"	13/16"	20,000	10	36259	■
	.014					36211	■

■ Packaged product available. See pages 131-141 for details.



36211

**P**

**CONCAVE BRUSHES 1/4" Stem** - Saucer-shaped radial wheels provide flexible brushing action for addressing corners and hard-to-reach areas.



Diameter	Wire Size	Face Width	Trim Length	Max. RPM	Standard Pack	Item Number	
						Steel	Stainless
1-1/2"	.006	1/4"	3/8"	20,000	10	17901	17930
	.008					17902	—
	.0118					17903	17931
2"	.008	3/8"	1/2"	20,000	10	17906	—
	.014					17907	17933
						17909	—
2-1/2"	.006	7/16"	5/8"	20,000	10	17912	17935
	.014					17914	17936
						17915	—
3"	.006	1/2"	15/16"	20,000	10	17914	17936
	.008					17915	—
	.014					17917	17937
						17922	—
4"	.008	9/16"	1-1/4"	20,000	10	17922	—
	.014					17923	—



17907

WHY WEILER

BONDED ABRASIVES

COATED ABRASIVES

NON-WOVEN ABRASIVES

POWER BRUSHES

NYLON BRUSHES

PACKAGED ITEMS

MAINTENANCE

# NYLON AND TAMPICO WHEELS



Deburring a plastic part using a nylon brush.

## NYLON WHEELS

Wheel brushes filled with non-metallic filaments are primarily intended for light-duty surface cleaning and scrubbing applications as well as scratch-free finishing and polishing. Synthetic filaments such as nylon are durable and provide a very flexible brushing action in applications requiring less aggression than a wire brush. The softer fill material allows them to be used on materials that a wire brush would scratch or gouge.

### APPLICATIONS

- Wet or dry cleaning and scrubbing
- Removing burrs and die flash from plastic parts
- Sweeping loose chips and debris

**P** **NYLON WHEELS** feature a chemical-resistant synthetic fill material with excellent bend recovery for use in applications requiring a soft, durable fill material.

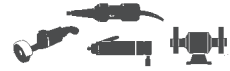

Diameter	Fill Diameter	Arbor Hole	Face Width	Trim Length	Max. RPM	Standard Pack	Item Number
2"	.010	1/2"	3/8"	1/2"	20,000	10	17223
	.014						17233
2-1/2"	.022	5/8"	3/8"	11/16"	20,000	10	99346
3"	.010	1/2"	3/8"	1"	20,000	10	29070
	.016						17263
6"	.016	2"	3/4"	1-1/2"	6,000	2	20490
8"	.020	2"	3/4"	2-1/2"	5,000	2	20510

For arbor hole reducing adapters, see Metal Adapter Table below and plastic adapters on page 75.



17233



20490

## TAMPICO WHEELS

Wheel brushes filled with non-metallic filaments are primarily intended for light-duty surface cleaning and scrubbing applications as well as scratch-free finishing and polishing. Natural vegetable fibers such as Tampico hold abrasive compounds well and can be used for deburring, edge blending, and polishing applications.

### APPLICATIONS

- Wet or dry cleaning and scrubbing
- Buffing and polishing non-ferrous and precious metals
- Removing burrs and blending edges with abrasive compounds

**P** **TAMPICO WHEELS** feature a durable vegetable fiber fill material that is chemical and heat resistant and also holds abrasive compounds well.

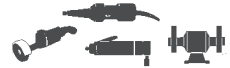

Diameter	Arbor Hole	Face Width	Trim Length	Max. RPM	Standard Pack	Item Number
2-1/2"	1/2"	1/2"	3/4"	20,000	10	17443
3"	1/2"	1/2"	1"	20,000	10	17453
6"	2"	5/8"	1-1/2"	6,000	10	20180
8"	2"	5/8"	2-1/2"	5,000	5	20190

For arbor hole reducing adapters, see Metal Adapter Table below and plastic adapters on page 75.



17453



20180

**P** **METAL ADAPTERS** for 6" & 8" Brushes. Used in pairs & priced per pair.

For Brush Arbor Hole Size	Adapted Arbor Hole Size	Standard Pack	Item Number
2"	1/2"	1 pair	03809
	5/8"	1 pair	03810
	3/4"	1 pair	03811
	7/8"	1 pair	03824
	1"	1 pair	03812
	1-1/4"	1 pair	03813
	1-1/2"	1 pair	03814



03809



# KNOT WIRE CUP BRUSHES

Cup brushes are for use on portable power tools for addressing larger surface areas more efficiently than a wheel brush. Cup brushes featuring a threaded nut are designed for smooth, efficient operation on angle grinders to make quick work of large jobs. Utility cup brushes featuring a permanently-attached 1/4" stem are more suitable for smaller jobs and are recommended for use on high-speed air tools for the most effective brushing action and longest life. Cup brushes are manufactured with individual knot hole and solid ring construction for high performance and long life.

## APPLICATIONS

- Removal of slag from the edges of plasma-cut or flame-cut plates
- Removing paint and coatings
- Cleaning rust, scale, and corrosion
- Deburring
- Weld prep and cleaning

## CUP BRUSH SIZE SELECTION GUIDE

Brush Sizes	Angle Grinder Size
2-3/4" & 3"	4"
2-3/4", 3" & 3-1/2"	4-1/2"
2-3/4", 3" & 3-1/2"	5"
3-1/2" & 4"	6"
4", 5" & 6"	7"
4", 5" & 6"	9"



Removing slag from a flame-cut steel plate.

**P**

**KNOT WIRE CUP BRUSHES - Single Row** - Provide heavy-duty brushing action with some flexibility; ideal for demanding cleaning applications on relatively flat surfaces.



Diameter	Wire Size	Arbor Hole	Trim Length	Max. RPM	Standard Pack	Item Number	
						Steel	Stainless
2-3/4"	.014	M10 x 1.25	1"	14,000	1	13015	-
		M10 x 1.50				13016	-
		M14 x 2.0				13020	-
		3/8"-24 UNF				13021	-
		5/8"-11 UNC				13025 ■	13009
2-3/4"	.020	M10 x 1.25	1"	14,000	1	13281 ■	13253
		M10 x 1.50				13282	13254
		M14 x 2.0				13283	13255
		3/8"-24 UNF				13284	13256
		1/2"-13 UNC				13285	13257
		5/8"-11 UNC				13286 ▲ ■	13258 ■
3-1/2"	.023	M10 x 1.25	7/8"	13,300	1	13150	-
		M10 x 1.50				13151	-
		M14 x 2.0				13152	13159
		3/8"-24 UNF				13153	13160
		1/2"-13 UNC				13155	-
5/8"-11 UNC	13156 ■	13163 ■					
3-1/2"	.014 .020	5/8"-11 UNC	1-1/4"	9,000	1	12736	-
						12746	-
4"	.014 .023 .035	5/8"-11 UNC	1-1/4"	10,200	1	12306 ▲	12406
						12316 ■	12416
						12326	-
4"	.023	5/8"-11 UNC	1-1/4"	10,200	1	12206 ❖	-
						12826*	-
5"	.014 .023	5/8"-11 UNC	1-3/8"	7,000	1	12256*	-
						12276 ■*	-
6"	.014 .023 .035	5/8"-11 UNC	1-3/8"	6,600	1	12356 ■	12456
						12376 ■	12476
						12396	-
6"	.023	5/8"-11 UNC	1-3/8"	6,600	1	12816*	-
6"	.014 .023 .035	5/8"-11 UNC	1-5/8"	6,000	1	12846	-
						12856	12886
						12866	-

\* With internal nut ❖ Cable Twist ■ Packaged product available. See pages 131-141 for details.

▲ Available in non-sparking bronze wire, see page 94-95 for details.



13016



13156



12276



13711

## NOTE

If a different arbor hole is required (than listed in the tables) refer to Threaded Adapter Chart shown on Pg. 67.

COATED ABRASIVES

NON-WOVEN ABRASIVES

POWER BRUSHES

NYLON BRUSHES

PACKAGED ITEMS

MAINTENANCE

**P**

**KNOT WIRE CUP BRUSHES - Hurricane Twist** - Very smooth brushing action and extended life with reduced cleaning action.



Diameter	Wire Size	Arbor Hole	Trim Length	Max. RPM	Standard Pack	Item Number
						Steel
2-3/4"	.014	M10 x 1.25	3/4"	14,000	1	13715
		M10 x 1.50				13716
		M14 x 2.0				13717
		5/8"-11 UNC				13718
2-3/4"	.020	M10 x 1.25	3/4"	14,000	1	13709
		M10 x 1.50				13710
		M14 x 2.0				13711
		5/8"-11 UNC				13712



36244

**V WOLVERINE™ KNOT WIRE CUP BRUSHES - Single Row**

Provide an aggressive brushing action for general-purpose surface cleaning applications.



Dia.	Wire Size	Arbor Hole	Trim Length	Max. RPM	Standard Pack	Item Number	
						Steel	Stainless
3"	.020	5/8"-11 UNC	1"	14,000	1	36238 ■	36239 ■
4"	.025	5/8"-11 UNC	1-1/4"	10,200	1	36244 ■	—
6"	.025	5/8"-11 UNC	1-3/8"	6,600	1	36245 ■	—

■ Packaged product available. See pages 131-141 for details.



13301

**P KNOT WIRE CUP BRUSHES - Banded - Single Row** - Feature a removable metal band around fill material to reduce the exposed trim length and limit brush flaring at operating speed to provide a very aggressive, controlled brushing action.



Diameter	Wire Size	Arbor Hole	Trim Length	Max. RPM	Standard Pack	Item Number	
						Steel	Stainless
2-3/4"	.014	5/8"-11 UNC	5/8"	12,500	1	13300	—
	.020					13301	13302
4"	.023	5/8"-11 UNC	7/8"	10,200	1	12301	—
5"	.023	5/8"-11 UNC	7/8"	6,600	1	12120	—

**P KNOT WIRE CUP BRUSH - 1-1/2 Rows** - Features an internal nut for use on dedicated equipment such as line traveling machines that clean and prep OD of pipe prior to coating.



Diameter	Wire Size	Arbor Hole	Trim Length	Max. RPM	Standard Pack	Item Number
						Steel
4"	.023	5/8"-11 UNC	1-1/4"	7,000	1	94012



12556

**P KNOT WIRE CUP BRUSHES - Double Row** - Provide very aggressive brushing while still maintaining some flexibility; ideal for severe cleaning applications.



Diameter	Wire Size	Arbor Hole	Trim Length	Max. RPM	Standard Pack	Item Number	
						Steel	Stainless
4"	.014	5/8"-11 UNC	1-1/4"	9,000	1	12756	—
	.020					12766	12726
	.023					12536	—
6"	.014	5/8"-11 UNC	1-3/8"	6,600	1	12536	—
	.023					12556	12636
	.035					12576	—
6"	.014	5/8"-11 UNC	1-1/2"	6,000	1	12906	—
	.023					12916	—
	.035					12926	—



12676

**P KNOT WIRE CUP BRUSHES - Banded - Double Row** - Feature a removable metal band around fill material to reduce the exposed trim length and limit brush flaring to provide an extremely aggressive, controlled brushing action for the most severe applications.



Diameter	Wire Size	Arbor Hole	Trim Length	Max. RPM	Standard Pack	Item Number
						Steel
4"	.020	5/8"-11 UNC	7/8"	9,000	1	12796
6"	.023	5/8"-11 UNC	7/8"	6,600	1	12676
						.035



35406

**P POLYFLEX™ ENCAPSULATED CRIMPED WIRE CUP BRUSHES** feature fill material that has been encapsulated in an elastomer that gradually wears away to keep only the wire tips exposed; ideal for applications on flat surfaces that require maximum aggression but no flexibility in the brushing action.



Diameter	Wire Size	Arbor Hole	Trim Length	Max. RPM	Standard Pack	Item Number
						Steel
3-1/2"	.014	5/8"-11 UNC	7/8"	12,000	1	35406
4"	.020	5/8"-11 UNC	1-1/8"	9,000	1	35186
6"	.020	5/8"-11 UNC	1-1/4"	6,000	1	35006
<b>Orange Elastomer* - Heavy-Duty</b>						
6"	.020	5/8"-11 UNC	1-1/4"	6,000	1	35530
<b>Black Elastomer* - Heavy-Duty - Heat-Resistant</b>						
6"	.020	5/8"-11 UNC	1-1/4"	6,000	1	35760

\* See Elastomer Color Code Chart on page 57 for more information.

**P** **CRIMPED WIRE CUP BRUSHES** provide very flexible brushing action and the most consistent performance for demanding light-duty cleaning applications; feature a threaded nut for use on angle grinders.



Diameter	Wire Size	Arbor Hole	Trim Length	Max. RPM	Standard Pack	Item Number	
						Steel	Stainless
3"	.014	M10 x 1.25	1"	14,000	1	13240 ■▲	—
		M10 x 1.50				13241	—
		M14 x 2.0				13242	—
		3/8"-24 UNF				13243	—
		1/2"-13 UNC				13244	—
		5/8"-11 UNC				13245 ■	—
3-1/2"	.014	M10 x 1.25	7/8"	13,300	1	13175	13182
		M10 x 1.50				13176	—
		M14 x 2.0				13177	13184
		3/8"-24 UNF				13178	13185
		1/2"-13 UNC				—	13187
		5/8"-11 UNC				13181 ■	13188
4"	.0118 .014 .020	5/8"-11 UNC	1-3/8"	10,200	1	14016	—
						14026 ■	—
						14036 ■▲	14126
5"	.014 .020	5/8"-11 UNC	1-1/4"	9,000	1	14206 ■▲	—
						14216	14256
6"	.014 .020	5/8"-11 UNC	1-1/4"	6,600	1	14066 ■*	—
						14076 ■▲*	14166*

\* With internal nut ▲ Available in non-sparking brass & bronze wire, see page 94-95 for details. ■ Packaged product available. See pages 131-141 for details.



Removing paint from a steel surface with a crimped wire cup brush.



13245



36236

### NOTE

If a different arbor hole is required (than listed in the tables) refer to Threaded Adapter Chart shown on Pg. 59.

**V** **WOLVERINE CRIMPED WIRE CUP BRUSHES** provide flexible brushing action and cost-effective performance in general purpose cleaning applications.



Diameter	Wire Size	Arbor Hole	Trim Length	Max. RPM	Standard Pack	Item Number	
						Steel	Stainless
3"	.014	5/8"-11 UNC	1"	14,000	1	36231 ■	14303
		1/2"-13 UNC				36232 ■	14304
4"	.020	5/8"-11 UNC	1-1/8"	9,000	1	36236 ■	14318
6"	.020	5/8"-11 UNC	1-1/2"	6,600	1	36237 ■	14319

■ Packaged product available. See pages 131-141 for details.

## CUP BRUSHES WITH STEM

Designed primarily for use on high speed die grinders, cup brushes with permanently attached stems can also be used on drills.

**P** **UTILITY CRIMPED WIRE CUP BRUSHES** are smaller diameter cup brushes which provide flexible brushing action and consistent performance for more demanding light-duty cleaning applications; featuring a 1/4" stem for use on air tools.



Diameter	Wire Size	Trim Length	Overall Length	Max. RPM	Standard Pack	Item Number	
						Steel	Stainless
1-3/4"	.006 .0118	3/4"	2-5/16"	13,000	10	14300 ▲	14303
						14301 ▲■	14304
2"	.008 .0118	5/8"	2-7/8"	13,000	10	14313	14318
						14306	14319
2-1/2"	.008 .014	7/8"	3-1/8"	13,000	10	14315	14320
						14317	14321
2-3/4"	.0118	7/8"	2-1/2"	6,000	1	14302 ■▲	—

■ Packaged product available. See pages 131-141 for details. ▲ Available in non-sparking brass wire, see page 94-95 for details.



14301

**V** **WOLVERINE UTILITY CRIMPED WIRE CUP BRUSH** is a flexible and economic small diameter brushing tool for a broad range of general purpose applications using air tools or drills. 1/4" Stem.



Diameter	Wire Size	Trim Length	Overall Length	Max. RPM	Standard Pack	Item Number
3"	.014	1"	3-1/4"	13,000	1	36230 ■

■ Packaged product available. See pages 131-141 for details.



36230

COATED ABRASIVES

NON-WOVEN ABRASIVES

POWER BRUSHES

NYLON BRUSHES

PACKAGED ITEMS

MAINTENANCE



# STEM-MOUNTED END BRUSHES



Cleaning hard-to-reach fillet welds on a gusseted base plate.

Wire end brushes are for use on high-speed portable power tools for addressing smaller surfaces and recessed areas. End brushes feature an integral 1/4" steel stem for safe operation at high speed and quick mounting into the collet or chuck of either electric or pneumatic die grinders.

End brushes are available in a variety of knot wire and crimped wire configurations for use in a broad range of applications, and they are manufactured with the highest quality construction for smooth, efficient performance and long life. Weiler's end brushes are available in heat-treated steel, Type 302 stainless steel, and bronze or brass wire.

## APPLICATIONS

- Cleaning ID's, internal passages and recessed areas
- Deburbing internal edges and crosshole intersections
- Removal of die flash and excess molded material
- Spot facing

**P** **KNOT WIRE END BRUSHES** feature a hollow end and heavy-duty brushing action with some flexibility; ideal for more demanding cleaning applications in recessed areas.



10026

Diameter	Wire Size	Trim Length	Overall Length	Max. RPM	Standard Pack	Item Number	
						Steel	Stainless
1/2"	.006	1-1/8"	2-7/8"	20,000	10	—	10215
	.0104					10208	10216
	.014					10217	10218
3/4"	.006	1-1/8"	2-7/8"	20,000	10	—	10220
	.0104					10210	10211
	.014	7/8"	2-5/8"	22,000	10025 ■	10029 ■	
	.020				10026 ■	10030	
1-1/8"	.006	1-1/8"	2-9/16"	20,000	10	10141 ■	10142 •
	.0104					10212	10213
	.0118					10187	—
	.014	7/8"	2-5/8"	22,000	10027 ■	10031 ■	
	.020				10028 ▲ ■	10032	

• Coated cup ■ Packaged product available. See pages 131-141 for details. ▲ Available in non-sparking bronze wire, see page 94-95 for details.

**P** **KNOT WIRE END BRUSHES - Nickel-plated Cup compliant with DOD MIL STD 2041D(SH)**

Feature a hollow end and heavy-duty brushing action with some flexibility; ideal for more demanding cleaning applications in recessed areas.

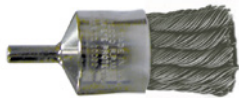

10392

Diameter	Wire Size	Trim Length	Overall Length	Max. RPM	Standard Pack	Item Number	
						Steel	Stainless
3/4"	.014	7/8"	2-5/8"	22,000	10	10387	10388
	.020					10392	10393
1-1/8"	.014	7/8"	2-5/8"	22,000	10	10392	10393

**V** **WOLVERINE™ KNOT WIRE END BRUSHES** feature similar hollow-end construction and heavy-duty brushing action, but they have been engineered to provide cost-effective use for less demanding applications.



36251

Diameter	Wire Size	Trim Length	Overall Length	Max. RPM	Standard Pack	Item Number	
						Steel	Stainless
3/4"	.014	7/8"	2-5/8"	22,000	10	36286	36287
	.020		2-9/16"			36250 ■	—
1"	.014	7/8"	2-5/8"	22,000	10	36288	36289
	.020		2-9/16"			36251 ■	—

■ Packaged product available. See pages 131-141 for details.

**P** **KNOT WIRE END BRUSHES - Banded** - Feature a pair of bands around the fill to reduce the exposed trim length and limit brush flaring to provide a very aggressive, controlled brushing action.



11141

Diameter	Wire Size	Trim* Length	Overall Length	Max. RPM	Standard Pack	Item Number	
						Steel	Stainless
1-1/8"	.014	3/8"	2-5/8"	18,000	10	11140	11141
	.020					11140	11141

\* Trim length from bands

**P** **CRIMPED WIRE END BRUSHES** feature a solid end construction and very flexible brushing action ideal for more demanding light-duty cleaning applications in corners and hard-to-reach areas.



Diameter	Wire Size	Trim Length	Overall Length	Max. RPM	Standard Pack	Item Number	
						Steel	Stainless
3/8"	.0118	7/8"	2-1/2"	20,000	10	10188	-
1/2"	.006	7/8"	2-9/16"	25,000	10	10001 ▲ ■	10013 ■
	.0104					10002	10014
	.014					10003	10015
	.020					10004	10016
3/4"	.006	7/8"	2-9/16"	22,000	10	10005 ■	10017 ■
	.0104					10006	10018
	.014					10007	10019
	.020					10008 ■	10020
1"	.006	1"	2-3/16"	22,000	10	10009 ▲ ■	10021 ■
	.0104					10010 ■	10022 ■
	.014	1-1/8"	2-15/16"	10011 ▲	10023		
	.020			10012 ■	10024		

■ Packaged product available. See pages 131-141 for details. ▲ Available in non-sparking brass wire, see page 94-95 for details.

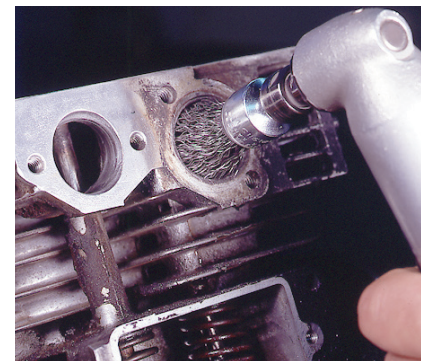

Cleaning the exhaust port of a gasoline engine.



10002

**P** **CRIMPED WIRE END BRUSHES - Coated Cup** - Feature a solid end construction and very flexible brushing action ideal for more demanding light-duty cleaning applications in corners and hard-to-reach areas. The plastic sleeve covering the cup protects the work surface from being scratched or marked.



Diameter	Wire Size	Trim Length	Overall Length	Max. RPM	Standard Pack	Item Number	
						Steel	Stainless
1/2"	.006	7/8"	2-9/16"	25,000	10	11000	11010
	.0104					11001	11011
3/4"	.006	7/8"	2-9/16"	22,000	10	11003	11013
	.0104					11004	11014
1"	.006	7/8"	2-3/4"	22,000	10	11006	11016
	.0104					1" 11007	11017



11013

**P** **CRIMPED WIRE END BRUSHES - Nickel-plated Cup** - Feature a solid end construction and very flexible brushing action ideal for more demanding light-duty cleaning applications in corners and hard-to-reach areas. **The nickel-plated cup is compliant with DOD MIL STD 2041D(SH).**



Diameter	Wire Size	Trim Length	Overall Length	Max. RPM	Standard Pack	Item Number	
						Steel	Stainless
1/2"	.006	7/8"	2-9/16"	25,000	10	10370	
	.0104					10371	
	.014					10372	
	.020					10373	
3/4"	.006	7/8"	2-9/16"	22,000	10	10374	
	.0104					10375	
	.014					10376	
	.020					10377	
1"	.006	1"	2-7/8"	22,000	10	10378	
	.0104					10379	
	.014	1-1/8"	2-15/16"	10380			
	.020			10381			



10374

**V** **WOLVERINE CRIMPED WIRE END BRUSHES** feature similar solid end construction and flexible brushing action, but they have been engineered to provide cost-effective use for less demanding applications.



Diameter	Wire Size	Trim Length	Overall Length	Max. RPM	Standard Pack	Item Number	
						Steel	Stainless
1/2"	.0104	7/8"	2-9/16"	25,000	10	36282	-
3/4"	.006	7/8"	2-9/16"	22,000	10	-	36283
	.0104					36247 ■	-
	.014					36246 ■	-
1"	.006	7/8"	2-3/4"	22,000	10	36284	36285
	.0104					36249 ■	-
	.014					36248 ■	-

■ Packaged product available. See pages 131-141 for details.



36247

COATED ABRASIVES

NON-WOVEN ABRASIVES

POWER BRUSHES

NYLON BRUSHES

PACKAGED ITEMS

MAINTENANCE



11112

**P** **CRIMPED WIRE END BRUSHES - Banded** - Feature bands around the fill to reduce the exposed trim length and limit brush flaring at operating speed to provide an aggressive, controlled brushing action.

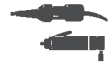

Diameter	Wire Size	Trim Length*	Overall Length	Max. RPM	Standard Pack	Item Number	
						Steel	Stainless
1/2"	.006	9/16"	2-9/16"	20,000	10	11100	11110
	.0104			25,000		11101	-
3/4"	.006	7/16"	2-11/16"	20,000	10	11102	11112
	.0104	3/8"				11103	11113
1"	.006	3/8"	2-5/8"	13,000	10	-	11114
	.0104					11105	11115

\* Trim length from bands



10310

**P** **\*CONTROLLED FLARE END BRUSHES** feature uniquely trimmed crimped wire fill for more effective brushing action and greatly enhanced durability when cleaning corners and fillet welds.



Diameter	Wire Size	Trim Length	Overall Length	Max. RPM	Standard Pack	Item Number	
						Steel	Stainless
1/2"	.0104	7/8"	2-9/16"	25,000	10	10301	10313
	.014					10302	10314
	.020					10303	10315
3/4"	.0104	7/8"	2-9/16"	22,000	10	10305	10317
	.014					10306	-
	.020					10307	10319
1"	.0104	1"	2-7/8"	22,000	10	10309	10321
	.014					10310	10322
1"	.020	1-1/8"	2-15/16"	22,000	10	10311	10323

\*Patent #8,186,000 B2

*The unique trim of a controlled flare end brush is designed specifically to address hard-to-reach areas, reducing filament fatigue and breakage typically associated with a standard end brush when cleaning corners and fillet welds.*



Standard Crimped Wire End Brush



Controlled Flare End Brush



10059

**P** **CRIMPED WIRE PILOT BONDING BRUSHES - Banded - Solid end.**

Originally designed to clean around rivet holes in aluminum aircraft panels but may be used in other similar applications.



Diameter	Wire Size	Trim Length	Overall Length	Pilot Diameter	Max. RPM	Standard Pack	Item Number	
							Steel	Stainless
1/2"	.005	3/8"	2-1/4"	3/32"	20,000	10		10056
				1/8"				10057
				5/32"				10058
				3/16"				10059

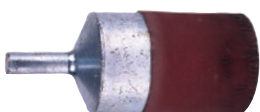

35350

**P** **POLYFLEX® ENCAPSULATED CRIMPED WIRE END BRUSHES**

**Burgundy Elastomer\*** - Feature fill material that has been encapsulated in an elastomer that gradually wears away to keep only the wire tips exposed; ideal for applications such as spot facing that may require maximum aggression and no flaring.

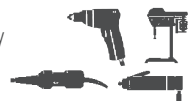

Diameter	Wire Size	Trim Length	Overall Length	Max. RPM	Standard Pack	Item Number	
						Steel	Stainless
1/2"	.0104	7/8"	2-9/16"	18,000	10	35340	35500
3/4"	.0104	7/8"	2-9/16"	16,000	10	35345	35505
1"	.0104	7/8"	2-3/4"	14,000	10	35350	-
<b>Orange Elastomer* - Heavy-Duty</b>							
1/2"	.0104	7/8"	2-9/16"	18,000	10	35535	-
3/4"	.0104	7/8"	2-9/16"	16,000	10	35540	-
1"	.0104	7/8"	2-3/4"	14,000	10	35545	-

\* See Elastomer Color Code Chart on page 57 for more information.



**P** **CIRCULAR FLARED END BRUSHES** feature crimped wire fill that has been “pre-flared” to match the working angle of the brush at operating speed; suited for addressing broad and slightly contoured surfaces.

Diameter	Wire Size	Max. RPM	Standard Pack	Item Number	
				Steel	Stainless
1"	.006	25,000	1	10033	10042
	.008			10034	10043
	.020			10099	—
1-1/4"	.006	20,000	1	10076	—
	.008			10035	—
	.020			10038	10047
1-1/2"	.006	20,000	1	10044	10045
	.008			10037	10046
	.020			10038	10047
2"	.014	25,000	2	11142	—
2-3/4"	.008	16,000	2	10039	10048
	.020			10040	—
	.014			10150	10151
3"	.006	16,000	2	10041 ■	10050
	.008			10134	—
	.014			10073	10074
	.020			—	96705
4"	.008	15,000	1	—	—

■ Packaged product available. See pages 131-141 for details.



10035



10041

**P** **POLYFLEX® ENCAPSULATED CIRCULAR FLARED END BRUSHES**

**Black Elastomer\*** - Crimped wire fill that has been encapsulated in a heavy-duty elastomer that gradually wears away to keep only the wire tips exposed. Their saucer-shape, narrow face, and aggressive brushing action make them suitable for addressing edges, corners, and confined areas.

O.D. Diameter	Wire Size	Cup Size	Overall Length	Max. RPM	Standard Pack	Item Number	
						Steel	Stainless
1-3/4"	.006	3/4"	2"	25,000	2	35222	—
	.0104					35223	35226
	.020					35224	—
2"	.0104	3/4"	1-1/8"	20,000	2	35233	—
	.020					35234	—

\* See Elastomer Color Code Chart on page 57 for more information.



35233

**P** **PENCIL END BRUSHES** contain straight wire fill material retained in a small diameter steel tube. They provide a light-duty brushing action suitable for very small recessed areas.

Tube Diameter	Wire Size	Trim Length	Overall Length	Max. RPM	Standard Pack	Item Number	
						Steel	Stainless
1/4"	.0104	3/4"	3-3/4"	8,000	10	99825	99823



99825

*When brushing a recessed area or the inside diameter of a tube, use an End Brush in the following manner: Insert the brush, start the brush rotating. Turn off the power before removing the brush. This will prevent the brush from flaring out and enable it to fit into the recessed area again.*



1. Insert Brush



2. Apply Power



3. Shut-Off Power



4. Remove Brush

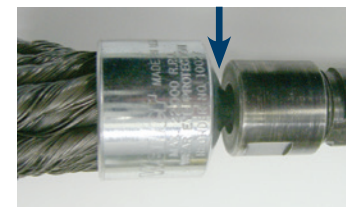

**MOUNT END BRUSHES SAFELY**

When mounting end brushes, the amount of overhang from the tool should be minimized by clamping on as much of the straight portion of the stem as possible. However, the collet or chuck should NOT clamp on the radius at the base of the stem to insure a secure hold before use. See photo above for the correct brush orientation.

# BORE-RX™ CROSSHOLE DEBURRING BRUSHES

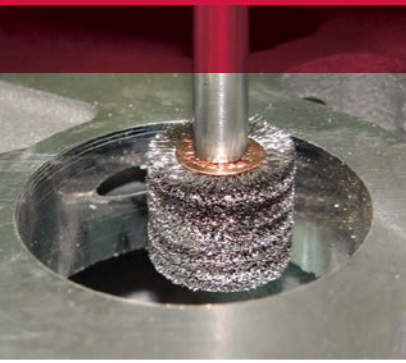

Deburring intersecting oil passages in an engine block.

Designed for automated use in CNC machining centers and dedicated equipment. They are densely filled for high aggression and long tool life and feature a 3/8" diameter steel stem with a flat for use in a collet or end-mill holder.

Bore-Rx brushes are ideal tools for removing burrs from internal edges. Since they can eliminate manual deburring operations, these internal brushing tools help to improve part-to-part consistency and reduce direct labor costs. Bore-Rx brushes are available in sizes ranging from 3/4" to 4" in diameter, and they are designed to be interpolated within bore sizes that are larger than the brush diameter.

## Operating Parameters For Wire Bore-Rx Brushes

Brush Diameter	Recommended RPM	Recommended Feed Rate
5/8" - 7/8"	8,000	20"/min
1" - 1-1/2"	8,000	20"/min
2" - 2-1/2"	6,000	20"/min
3" - 4"	3,000	20"/min

## Tool Paths for Crosshole Deburring

An effective tool path for most crosshole deburring jobs is circular interpolation using the following guidelines to determine diameter of interpolation. The interpolation should be performed at a depth where the center of the brush face is at the center of the intersecting hole.

- Diameter of Interpolation = Hole Diameter - Brush Diameter



**BORE-RX BRUSHING TOOLS - Crimped wire fill** - Feature dense wire fill for aggressive deburring action on ductile metals and other hard-to-deburr materials.

Diameter	Wire Size	Face Width	Overall Length	Max. RPM	Standard Pack	Item Number
						Steel*
3/4"	.005	3/8"	4-3/8"	8,000	1	17202
		3/4"	4-3/4"			17203
7/8"	.006	3/4"	4-3/4"	8,000	1	17205
1"	.006	3/4"	5"	8,000	1	17207
1-1/4"	.006	3/4"	4-3/4"	8,000	1	17209
1-1/2"	.006	1"	5"	8,000	1	17211
2"	.006	1"	4-1/4"	6,000	1	17214
2-1/2"	.008	1"	4-3/4"	6,000	1	17216
3"	.008	1"	5-1/4"	6,000	1	17218
4"	.0118	1"	6-1/4"	6,000	1	17219

\* Stainless Steel fill is available by special order.

Note: All Bore-Rx brush stems have a 2" long flat for use in end mill holders. Alternatively, they can be mounted in 3/8" collets. Bore-Rx extension holder is available. Contact Application Engineering at 888-299-APPS (2777).



17205



17218

## CUSTOMIZABLE CROSSHOLE DEBURRING SOLUTIONS

### Replacement Bore-Rx Brush Heads and Reusable Bore-Rx Arbors

In high production applications, reusable arbors reduce manufacturing costs by allowing the use of inexpensive brush head replacements. Brush heads are made-to-order in diameters ranging from 3/4" to 1-1/2" with face widths of 1/4" to 1". They are available on 3/16" and 1/4" pins. The pin diameter is based on the application and determines brush density. Contact Application Engineering at 888-299-APPS (2777) for more information.



Replacement Head



Reusable Extension 03991



Reusable Arbor

# POWER AND HAND TUBE BRUSHES

Weiler offers a comprehensive line of power and hand tube brushes for internal cleaning and deburring applications in tubing, pipe, drilled-and-tapped holes, and machined bores and passages. Due to their twisted-in-wire construction, the use of power tube brushes is limited to low-speed power tools such as drills and drill presses and to CNC and manual machine tools in which the RPM can be precisely programmed or set. In addition, they should not be used in reverse rotation to prevent unraveling of the stem wire. Available in a wide variety of brush configurations and fill materials, Weiler can supply a tube brush for any application. If you do not see what you need in this catalog, see the Special Tube Brush Design Specification Sheet on page 83, or call our toll-free Application Engineering Hotline at 888-299-APPS (2777) for assistance.

## APPLICATIONS

- Deburring and cleaning drilled-and-tapped holes and other internal threads
- Cleaning and finishing the ID of tubing and pipe
- Crosshole deburring
- Removing burrs and chips from internal keyways, slots, and grooves
- Removing paint, coatings, and build-up other foreign material from the surfaces of bores and passages



Removing zinc coating from holes in a brake bracket.

## POWER AND HAND TUBE BRUSH SELECTION TIPS

- A flat burr style tube brush is most effectively used with a holder on blind, threaded holes.
- A round tube brush is most effectively used fully chucked on smooth or threaded blind holes.
- A single stem, single spiral tube brush is most effectively used for manual or hand cleaning applications.
- A double stem, double spiral tube brush is most effectively used with power tools for heavy-duty cleaning and deburring.
- A polyflex encapsulated double stem, double spiral tube brush is most effectively used on power tools for very aggressive cleaning and deburring applications.



**P** **DOUBLE STEM, DOUBLE SPIRAL** feature four stem wires and a double spiral of straight wire fill material to provide aggressive cleaning and deburring action.



Diameter	Wire Size	Brush Part	Stem Diameter	Overall Length	Max. RPM	Standard Pack	Item Number	
							Steel	Stainless
3/8"	.003	1-1/2"	1/8"	4"	2,000	10	21342	—
	.006	2-1/8"		6"			21232	—
1/2"	.004	2"	5/32"	5"	2,000	10	21106	21116
	.006						21107 ▲ ■	21117
	.0104						21252	—
5/8"	.005	2"	7/32"	5"	2,000	10	21108 ■	21118
	.008						21109 ▲	21119
	.0104						21184	—
3/4"	.006	2-1/2"	1/4"	5-1/2"	2,000	10	21110 ▲ ■	21120
	.008						21247	—
	.0104						21111	21121
7/8"	.006	2-1/2"	1/4"	5-1/2"	2,000	10	21112	21122
	.0104						21113	21123
1"	.006	2-1/2"	1/4"	5-1/2"	2,000	10	21114 ▲ ■	21124
	.0104						21115	21125
1-1/4"	.006	2-1/2"	1/4"	5-1/2"	2,000	10	21164	21245
	.0104						21167 ★	21236
1-1/2"	.014	2-1/2"	1/4"	5-1/2"	2,000	10	—	21413

■ Packaged product available. See pages 131-141 for details. ★ 5" Overall length

▲ Available in non-sparking brass wire, see page 94-95 for details.



COATED ABRASIVES

NON-WOVEN ABRASIVES

POWER BRUSHES

NYLON BRUSHES

PACKAGED ITEMS

MAINTENANCE



## P POLYFLEX™ ENCAPSULATED DOUBLE STEM, DOUBLE SPIRAL

Burgundy Elastomer\* - Encapsulated with an elastomer that leaves only the sharp wire tips exposed for maximum aggression and a very rigid brushing action.



35825

Diameter	Wire Size	Brush Part	Stem Diameter	Overall Length	Max. RPM	Standard Pack	Item Number	
							Steel	
1/2"	.006	2"	5/32"	5"	2,000	10	35821	
5/8"	.0104	2"	7/32"	5"	2,000	10	35822	
3/4"	.0104	2-1/2"	1/4"	5-1/2"	2,000	10	35823	
1"	.0104	2-1/2"	1/4"	5-1/2"	2,000	10	35825	

\* See Elastomer Color Code Chart on page 57 for more information.

## P ROUND - Feature a single continuous length of stainless steel stem wire and a single spiral of crimped wire fill for a more flexible brushing action; for use on smooth or threaded blind holes.



21074

Diameter	Wire Size	Brush Part	Stem Diameter	Overall Length	Max. RPM	Standard Pack	Item Number	
							Steel	Stainless
1/4"	.004	1"	1/8"	3-1/2"	2,000	10	21072 ▲	21081 ■
5/16"	.005	1"	1/8"	3-1/2"	2,000	10	21175	—
3/8"	.004	1"	1/8"	3-1/2"	2,000	10	21073 ■	21082
	.006						—	
	.008						21264	21240
7/16"	.005	1"	1/8"	3-1/2"	2,000	10	21142	21181
1/2"	.005	1"	3/16"	3-1/2"	2,000	10	21074 ▲ ■	21083
							—	—
9/16"	.005	1"	3/16"	3-1/2"	2,000	10	21143	—
							—	21404
5/8"	.005	1"	3/16"	3-1/2"	2,000	10	21075 ■	21084
							21265	—
11/16"	.005	1"	3/16"	3-1/2"	2,000	10	21144	—
3/4"	.006	1"	7/32"	3-1/2"	2,000	10	21076	21085
							21266	—
13/16"	.005	1"	7/32"	3-1/2"	2,000	10	21146	—
7/8"	.006	1"	7/32"	3-1/2"	2,000	10	21077 ■	21086
							21267	—
15/16"	.005	1"	7/32"	3-1/2"	2,000	10	21148	—
1"	.005	1"	1/4"	3-1/2"	2,000	10	21149	21340
							21078 ■	21087
1-1/8"	.005	1"	1/4"	3-1/2"	2,000	10	21150	—
							21079	21088
1-1/4"	.008	1"	1/4"	3-1/2"	2,000	10	21080	21089
							—	—
1-1/2"	.008	1"	1/4"	3-1/2"	2,000	10	21203 ▲	—
							21269	—
2-1/4"	.008	1"	1/4"	3-1/2"	2,000	10	21322	—

■ Packaged product available. See pages 131-141 for details. ▲ Available in non-sparking brass wire, see page 94-95 for details.

Correct Mounting in Chuck



Incorrect Mounting in Chuck



## TUBE BRUSH OPERATING RECOMMENDATIONS

The stems in power tube brushes are not as strong as the stems in most other brushes. Therefore, it is very important to avoid any load conditions and brush speeds that can cause excessive stem deflections and destructive bending.

A suggested guideline to avoid this unsafe condition is minimizing the overhang of the stem to under an inch, and running the brush at speeds below 2,000 RPM.

Increasing overhang could decrease the safe speed at which the brush can operate. To reach into deeper holes, use drill extension rods instead of increasing stem overhang.

### BEFORE STARTING THE BRUSH:

- Secure brush in chuck.
- Ensure clockwise brush rotation (running the brush counter-clockwise could cause the brush to fall apart.)
- Clamp work securely.
- Position all guards in place.
- Align brush with the work so the brush rotates on its true centerline to prevent any stem deflections.
- Guide the brush into the hole before starting the brush rotation.
- Always wear eye protection.

**P BURRITE** - Feature a single continuous length of stainless steel stem wire and filled with a tuft of crimped wire to provide an aggressive flat side action; ideal for cleaning and deburring internal threads.



Diameter	Wire Size	Brush Part	Stem Diameter	Overall Length	Max. RPM	Standard Pack	Item Number	
							Steel	Stainless
1/4"	.003	9/16"	3/32"	2-1/8"	2,000	10	21000	-
	.005						21001	21050
5/16"	.003	9/16"	3/32"	2-1/8"	2,000	10	21004	-
	.005						21005	-
3/8"	.003	9/16"	3/32"	2-1/8"	2,000	10	21008	-
	.005		1/8"				21009	21051
	.005		1/8"				21023	-
7/16"	.003	9/16"	3/32"	2-1/8"	2,000	10	21014	-
	.005						21015	-
1/2"	.003	9/16"	3/32"	2-1/8"	2,000	10	21020	-
	.005						21021	21053
	.005						1/8"	21025
9/16"	.003	5/8"	1/8"	2-1/4"	2,000	10	21027	-
	.005						21028	-
5/8"	.003	5/8"	1/8"	2-1/4"	2,000	10	21030	-
	.005						21031	21055
3/4"	.005	5/8"	1/8"	2-1/4"	2,000	10	21034	21056
	.008						21035	-
7/8"	.005	5/8"	1/8"	2-1/4"	2,000	10	21036	21057
	.008						21040	21058
1"	.005	5/8"	1/8"	2-1/4"	2,000	10	21041	-
	.008						21041	-
1-1/8"	.005	5/8"	1/8"	2-1/4"	2,000	10	21044	-

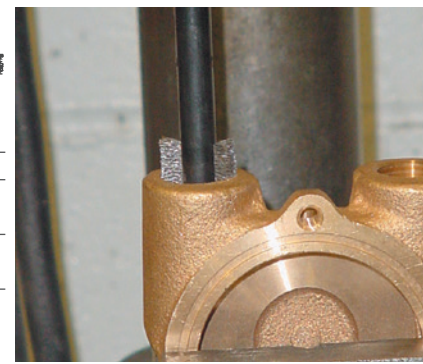

Deburring the threads of a tapped hole using a burrite brush in a holder.



21014



21040

**P BURRITE HOLDERS** - Feature a 1/4" stem for convenient mounting into the chuck of a drill or the collet of a machine tool and allow the brush to be used in either direction of rotation. They allow the brush to be used in a standard tapping cycle for deburring threaded holes in CNC machining centers.



For Brush Stem Dia.	Holder Diameter	Overall Length	Standard Pack	Item Number
3/32"	1/4"	3-1/8"	5	95202
1/8"	3/8"	3-3/8"	5	95203



95203

**P SINGLE STEM, SINGLE SPIRAL** - Feature a single continuous length of galvanized steel stem wire with a formed eye loop for convenient hand use. The single spiral of straight wire fill allows for easy manual insertion into the ID.

Diameter	Wire Size	Brush Part	Stem Diameter	Overall Length	Standard Pack	Item Number	
						Steel	Stainless
1/8"	.003	1"	3/32"	6"	10	21246	21249
	.005					21090 ▲	21098
3/16"	.003	1-1/2"	3/32"	7"	10	21091	21099
	.005					21092 ▲	21100
	.006					21093 ▲	21101
1/4"	.003	1-1/2"	3/32"	7"	10	21161	-
	.005					21094 ▲	21414
	.006					21095	21103
3/8"	.004	2"	1/8"	8"	10	21096 ▲	21104
	.006					21097	21105
	.008					21162	-
1/2"	.004	2"	1/8"	8"	10	21233	-
	.006					21233	-
9/16"	.005	2-1/2"	5/32"	9"	10	21233	-
	.008					21233	-

▲ Available in non-sparking brass wire, see page 94-95 for details.



21095

Key:

**P** Performance line  
Industrial Grade

**V** Value line  
Professional Grade

COATED ABRASIVES

NON-WOVEN ABRASIVES

POWER BRUSHES

NYLON BRUSHES

PACKAGED ITEMS

MAINTENANCE

**P** **NYLON HAND TUBE BRUSHES** feature a single continuous length of galvanized steel stem wire with a formed eye loop for convenient hand use. The single spiral of straight nylon fill allows for easy manual insertion and scratch-free cleaning of the ID.



Diameter	Fill Diameter	Brush Part	Stem Diameter	Overall Length	Standard Pack	Item Number
						Nylon
1/4"	.005	2"	3/32"	6-1/4"	36	44110
3/8"	.005	2"	3/32"	6-1/4"	36	44213
1/2"	.010	3"	1/8"	8-1/2"	36	44111
3/4"	.012	3"	1/8"	8-1/2"	36	44112
1"	.014	4"	5/32"	12-1/4"	36	44113
1-1/4"	.014	4"	5/32"	13"	36	44114
2"	.014	5"	3/16"	16-3/4"	36	44115

**P** **PERCOLATOR BRUSH** features single stem, single spiral construction with an eye loop and straight white nylon fill. Intended for cleaning the internal passages in coffee percolators, this brush can be also be used in other similar manual cleaning applications.



Diameter	Fill Diameter	Brush Part	Stem Diameter	Overall Length	Standard Pack	Item Number
						Nylon
7/16"	.010	3-1/2"	5/32"	11-1/2"	10	44316

**P** **VALVE GUIDE BRUSHES** are made with single stem, single spiral construction and have a permanently-attached 1/4" diameter long steel handle for convenient hand use or for mounting into a chuck. Intended for removing heavy deposits from valve guides in gas and diesel engines, these brushes can also be used in a range of other similar applications.



Diameter	Fill Diameter / Material	Brush Part	Overall Length	Max. RPM	Standard Pack	Item Number
1/4"	.0104 Steel	2"	10"	2,000	10	95563
5/16"						95027
11/32"						95566
3/8"						95028
7/16"						95665
1/2"	95029					
11/32"	.008 Nylon	2-1/2"	10"	2,000	10	95660
3/8"	.012 Nylon					95567

**P** **GUN CLEANING BRUSHES - Rifle Brushes** - Constructed using a continuous piece of stem wire and fine bronze wire fill for a scratch-free cleaning action in gun barrels, these flexible tube brushes are designed to be attached to extension rods using the 8-32 male coupling.

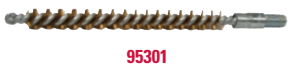

Caliber	Brush Part	Overall Length	Coupling Size	Standard Pack	Item Number
					Bronze
22	2-1/4"	3-1/4"	8-32	10	95301
30	2-1/4"	3-1/4"	8-32	10	99786
35	2-1/4"	3-1/4"	8-32	10	99788
45	2-1/4"	3-1/4"	8-32	10	99791

**P** **GUN CLEANING BRUSHES - Shotgun Brushes** - Constructed using a continuous piece of stem wire and fine bronze wire fill for a scratch-free cleaning action in gun barrels, these flexible tube brushes are designed to be attached to extension rods using the 5/16"-27 male coupling.



Gauge	Brush Part	Overall Length	Coupling Size	Standard Pack	Item Number
					Bronze
12	1-5/8"	2-7/8"	5/16-27	10	99714
16	1-5/8"	2-7/8"	5/16-27	10	99694
20	1-5/8"	2-7/8"	5/16-27	10	95084
410	1-5/8"	2-7/8"	5/16-27	10	95129



**SPECIAL BRUSH DESIGNS** - Design a power tube brush for your specific application.

**SPECIAL TUBE BRUSH SPECIFICATION SHEET:**

(Use the illustration on this page as a guide)

- |   |  |
|---|--|
| <p>1. Brush diameter _____</p> <p>2. Length of brush part _____</p> <p>3. Overall brush length _____</p> <p>4. Special stem diameter (if required) _____</p> <p>5. Stem material:<br/> <input type="checkbox"/> Galvanized Steel   <input type="checkbox"/> Stainless   <input type="checkbox"/> Other</p> <p>6. Application _____<br/>         _____</p> | <p>7. Brush fill material:<br/> <input type="checkbox"/> Steel wire   <input type="checkbox"/> Stainless wire<br/> <input type="checkbox"/> Nylon Abrasive Filament (Nylox®)<br/> <input type="checkbox"/> Brass wire   <input type="checkbox"/> Other _____</p> <p>8. Fill material diameter _____</p> <p>9. Special tip style (if required) _____</p> <p>10. <input type="checkbox"/> Single stem   <input type="checkbox"/> Double stem</p> <p>11. Order Quantity _____</p> |
|---|--|

\* Special tube brushes are not returnable, as they are manufactured to order.

Name: \_\_\_\_\_  
 Company Name: \_\_\_\_\_  
 Address: \_\_\_\_\_  
 Phone: (\_\_\_\_) \_\_\_\_\_  
 Fax: (\_\_\_\_) \_\_\_\_\_  
 E-mail: \_\_\_\_\_

End-User Name: \_\_\_\_\_  
 City: \_\_\_\_\_  
 State: \_\_\_\_\_ Zip: \_\_\_\_\_

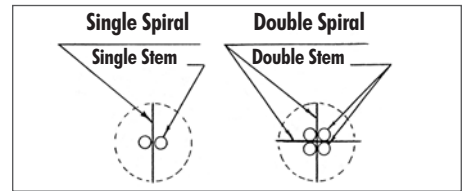
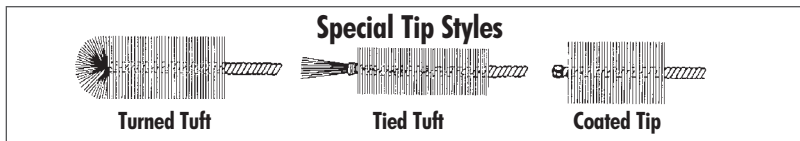
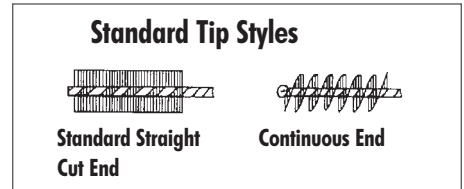
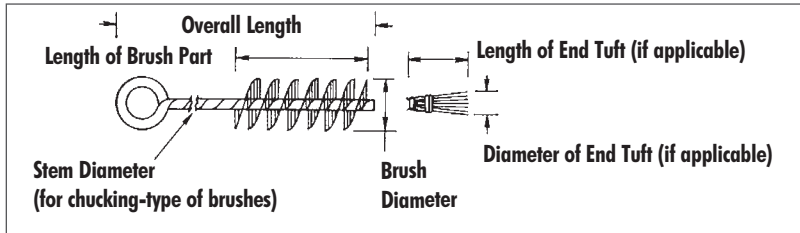

**FOR ADDITIONAL INFORMATION CALL:**  
 Weiler's Application Engineering  
 Hotline toll free at:  
 888-299-APPS (2777)

**FAX SPECIFICATION SHEET TO:**  
 Application Engineering  
 Fax: 800-635-3615

# MINIATURE BRUSHES



Removing galled spots from a metal forming die.

**THE WEILER FAMILY** began producing miniature brushes for the jewelry industry in 1898, and their tradition of providing the highest quality, most cost-effective products continues to this day.

Weiler's line of miniature brushes are designed for precision cleaning, light deburring, and finishing applications in a variety of crafts, trades, and industries. In addition to use in jewelry production and in dental and optical labs, miniature brushes have many applications in modern industries such as electronics and instrumentation production, aerospace and aircraft manufacture, and precision tool and die shops. They are permanently mounted on 1/8" or 3/32" stems for quick mounting and efficient use on high-speed electric rotary tools and air-powered pencil die grinders.

## APPLICATIONS

- Decorative finishing
- Light deburring and edge blending
- Buffing and polishing of small parts
- Light-duty cleaning

## P WIRE WHEEL BRUSHES - Fine crimped wire fill for light-duty cleaning and deburring.



99554



26144

Diameter	Wire Size	Trim Length	Stem Size	Stem Length	Max. RPM	Standard Pack	Item Number		
							Steel	Stainless	Brass
5/8"	.005	1/8"	1/8"	1-1/2"	37,000	144	—	99554	—
3/4"	.003	3/16"	1/8"	1-1/2"	37,000	144	26000	—	26001
	.005	3/16"	1/8"	1-1/2"			26003	26005	26004
3/4"	.003	3/16"	3/32"	1-1/2"	37,000	144	26140	—	26141
	.005	3/16"	3/32"	1-1/2"			26143	—	26144
1"	.003	5/16"	1/8"	1-1/2"	37,000	144	26012	26014	—
	.005	5/16"	1/8"	1-1/2"			26015	26017	26016
	.005	5/16"	3/32"	1-1/2"			26155	—	—
1-1/4"	.005	3/8"	1/8"	1-1/2"	37,000	144	26021	—	—
1-1/2"	.005	1/2"	1/8"	1-1/2"	25,000	144	26296	26294	—

## P BRISTLE WHEEL BRUSHES - Natural hair fill for scratch-free cleaning of small parts or for buffing and polishing of features such as slots and grooves using abrasive compounds.

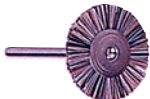

26041

Diameter	Fill Type	Trim Length	Stem Size	Stem Length	Max. RPM	Standard Pack	Item Number
3/4"	Stiff Hair	3/16"	3/32"	1-1/2"	37,000	144	26041
	Soft Hair						26042
	Stiff Hair*						26043
	Stiff Hair						26059

\* Double thick

## P WIRE CUP BRUSHES - Fine crimped wire fill for light-duty cleaning or deburring in confined areas.

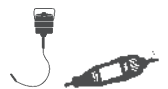

26074

Dia.	Wire Size	Trim Length	Stem Size	Stem Length	Overall Length	Max. RPM	Standard Pack	Item Number		
								Steel	Stainless	Brass
5/8"	.003	1/4"	1/8"	1-1/2"	2"	37,000	144	26071	—	26072
	.005							26074	26076	26075

## P BRISTLE CUP BRUSHES - Natural hair fill for scratch-free cleaning of confined areas or for buffing and polishing of small recessed surfaces using abrasive compounds.



26095

Dia.	Fill Type	Trim Length	Stem Size	Stem Length	Overall Length	Max. RPM	Standard Pack	Item Number
1/2"	Stiff Hair	7/32"	3/32"	1-1/2"	2"	37,000	144	26091
9/16"	Stiff Hair	1/4"	1/8"	1-1/2"	2"	37,000	144	26093
	Soft Hair							26094
1"	Stiff Hair	7/16"	1/8"	1-1/2"	2-3/8"	25,000	144	26095
	Soft Hair							26096

**P WIRE END BRUSHES** - Fine crimped wire fill for light-duty cleaning or deburring in very small recessed areas or ID's.



Dia.	Wire Size	Trim Length	Stem Size	Stem Length	Overall Length	Max. RPM	Standard Pack	Item Number		
								Steel	Stainless	Brass
3/16"	.003	1/4"	1/8"	1-1/4"	1-7/8"	37,000	144	26098	26099	26097
			3/32"					-	-	
1/4"	.005	7/16"	1/8"	1-1/4"	2-1/8"	37,000	144	26107	26108	26106
5/16"	.005	9/16"	1/8"	1-1/4"	2-3/8"	25,000	144	26113	26114	-



26114

**P BRISTLE END BRUSHES** - Natural hair fill for scratch-free cleaning or for buffing and polishing of very small recesses using abrasive compounds.



Dia.	Fill Type	Trim Length	Stem Size	Stem Length	Overall Length	Max. RPM	Standard Pack	Item Number
3/16"	Stiff Hair	1/4"	1/8"	1-1/4"	1-7/8"	37,000	144	26115
	Soft Hair		26122					
	Stiff Hair		3/32"					26116
1/4"	Stiff Hair	3/8"	1/8"	1-1/4"	2-1/8"	37,000	144	26119
5/16"	Stiff Hair	9/16"	1/8"	1-1/4"	2-3/8"	25,000	144	26121



26121

**P BRISTLE END BRUSHES - Plastic Ferrule**

Feature a plastic ferrule or cup to protect internal surfaces during use.



Dia.	Fill Type	Trim Length	Stem Size	Stem Length	Overall Length	Max. RPM	Standard Pack	Item Number
3/16"	Stiff Hair	1/4"	1/8"	1-1/4"	1-7/8"	37,000	144	26128
1/4"	Stiff Hair	3/8"	1/8"	1-1/4"	2-1/8"	37,000	144	26131
5/16"	Stiff Hair	9/16"	1/8"	1-1/4"	2-3/8"	25,000	144	26133



26133

**P ABRASIVE NYLON END BRUSHES - Plastic Ferrule** - Nylox® abrasive nylon fill for buffing and polishing without compounds. They can also be used in automated applications for precision deburring and finishing of small part features.



Dia.	Filament Dia./Grit	Trim Length	Stem Size	Stem Length	Overall Length	Max. RPM	Standard Pack	Item Number
3/16"	.018/500	1/4"	1/8"	1-1/4"	1-7/8"	37,000	144	26136
1/4"	.018/500	3/8"	1/8"	1-1/4"	2-1/8"	37,000	144	26138
5/16"	.018/500	9/16"	1/8"	1-1/4"	2-3/8"	25,000	144	26146



26136

*Deburring the I.D. of a small machined part with miniature wire end brush.*



Key:

**P** Performance line  
Industrial Grade

**V** Value line  
Professional Grade

WHY WEILER  
BONDED ABRASIVES  
COATED ABRASIVES  
NON-WOVEN ABRASIVES  
POWER BRUSHES  
NYLOX BRUSHES  
PACKAGED ITEMS  
MAINTENANCE



# NON-SPARKING BRUSHES



Creating an antique finish on a brass plate.

Weiler offers an assortment of wire non-sparking brushes featuring high-quality bronze or brass wire that offer a very soft brushing action in comparison to steel and stainless steel and will not generate a spark when used on metal surfaces. These products are available in a variety of knot wire and crimped wire configurations for use in a broad range of surface cleaning applications, and they are manufactured with individual knot hole and solid ring construction for high performance and long life. Weiler's non-sparking power brushes are available with plain arbor holes, nuts, and permanently-attached stems for use on a variety of tools.

## APPLICATIONS

- Light to medium duty cleaning of surfaces, recesses, and ID's
- Deburring component parts machined from soft, non-ferrous metals
- Cleaning molds and dies in the injection-molding and extrusion of plastics
- Maintenance activities in areas where flammable or potentially explosive materials are present, such as refineries and petrochemical plants.



13121

**P** **STANDARD TWIST WHEELS** provide a heavy-duty brushing action with some flexibility; ideal for more demanding cleaning applications.



Dia.	Wire Size	Arbor Hole	No. of Knots	Face Width	Trim Length	Max. AH Avail.	Thickness at Face Plates	Max. RPM	Std. Pack	Item Number
										Bronze
3"	.020	1/2" - 3/8"	20	3/8"	5/8"	1/2"	7/16"	25,000	10	08271
4"	.020	5/8" - 11	24	1/2"	7/8"	-	7/16"	20,000	5	13121

For threaded arbor hole adapters see page 67.



01475

**P** **CRIMPED WIRE WHEELS** provide a flexible brushing action and consistent performance for light-duty cleaning and deburring applications.



Diameter	Wire Size	Arbor Hole	Face Width	Trim Length	Max. AH Avail.	Thickness at Face Plates	Max. RPM	Standard Pack	Item Number
									Brass
6"	.005	5/8" - 1/2"	1/2"	1-7/16"	1-1/4"	7/16"	6,000	2	01415
	.0118								01475

For arbor hole adapters see page 72. For other available arbor holes, see Arbor Hole Variations Table on page 57.

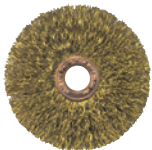

29078

**P** **SMALL DIAMETER CRIMPED WIRE WHEELS** provide a flexible brushing action and consistent performance for light-duty cleaning and deburring applications requiring a small wheel.



Diameter	Wire Size	Arbor Hole	Face Width	Trim Length	Max. RPM	Standard Pack	Item Number
							Brass
1-1/2"	.005	3/8"	1/4"	7/16"	20,000	10	29178
2"	.005	1/2"	3/8"	1/2"	20,000	10	29059
	.0118						29086
3"	.014	1/2"	5/8"	1"	20,000	10	29078

For adapters and drive arbors see page 75.



17641

**P** **CONFLEX BRUSH** - Small diameter wheels permanently mounted onto a 1/4" stem to provide a very flexible brushing action.



Diameter	Wire Size	Face Width	Trim Length	Max. RPM	Standard Pack	Item Number
						Brass
3"	.0118	1/2"	1"	20,000	10	17641 ■

■ Packaged product available. See pages 131-141 for details.



13299

**P** **KNOT WIRE CUP BRUSHES** provide heavy-duty brushing action with some flexibility for more demanding cleaning applications on relatively flat surfaces.



Diameter	Wire Size	Arbor Hole	Trim Length	Max. RPM	Standard Pack	Item Number
						Bronze
2-3/4"	.020	5/8"-11 UNC	1"	14,000	1	13299
4"	.020	5/8"-11 UNC	1-1/4"	10,200	1	12776

For threaded arbor hole adapters see page 67.

**P** **CRIMPED WIRE CUP BRUSHES** provide a very flexible brushing action for light-duty cleaning applications on somewhat irregular surfaces.



Diameter	Wire Size	Arbor Hole	Trim Length	Max. RPM	Standard Pack	Item Number	
						Bronze	Brass
3"	.020	5/8"-11 UNC	7/8"	14,000	1	13231	—
4"	.020	5/8"-11 UNC	1-3/8"	10,200	1	14616	—
5"	.014	5/8"-11 UNC	1-1/4"	8,000	1	—	14606
6"	.020	5/8"-11 UNC	1-1/4"	6,600	1	14316*	—

\* With internal nut For threaded arbor hole adapters see page 67.



14316

**P** **UTILITY CRIMPED WIRE CUP BRUSHES** - Smaller diameter cup brushes that provide a flexible brushing action for light-duty cleaning applications.



Diameter	Wire Size	Trim Length	Stem Diameter	Overall Length	Max. RPM	Standard Pack	Item Number
							Brass
1-3/4"	.006	3/4"	1/4"	2-5/16"	13,000	10	14310
							14314
2-3/4"	.0118	7/8"	1/4"	2-1/2"	6,000	1	14311



14314

**P** **KNOT WIRE END BRUSH** features a hollow end and heavy-duty brushing action with some flexibility; ideal for more demanding cleaning applications in recessed areas.



Diameter	Wire Size	Trim Length	Stem Diameter	Overall Length	Max. RPM	Standard Pack	Item Number
							Bronze
1-1/8"	.020	7/8"	1/4"	2-5/8"	22,000	10	10067



10067

**P** **CRIMPED WIRE END BRUSHES** feature a solid end and very flexible brushing action ideal for light-duty cleaning applications in corners and hard-to-reach areas.



Diameter	Wire Size	Trim Length	Stem Diameter	Overall Length	Max. RPM	Standard Pack	Item Number
							Brass
1/2"	.005	7/8"	1/4"	2-9/16"	25,000	10	10158
1"	.005	7/8"	1/4"	2-5/8"	20,000	10	10128
1"	.0118	1"	1/4"	2-5/8"	22,000	10	10091



10158

**P** **DOUBLE STEM, DOUBLE SPIRAL POWER TUBE BRUSHES** - Constructed with four stem wires and a double spiral of straight wire fill material to provide a more aggressive internal cleaning action.



Diameter	Wire Size	Brush Part	Stem Diameter	Overall Length	Standard Pack	Item Number
						Brass
1/2"	.006	2"	5/32"	5"	10	21178
5/8"	.008	2"	7/32"	5"	10	21219
3/4"	.006	2-1/2"	1/4"	5-1/2"	10	21179
1"	.006	2-1/2"	1/4"	5-1/2"	10	21218



21178

**P** **ROUND POWER TUBE BRUSHES** feature a single continuous length of stainless steel stem wire and a single spiral of crimped wire fill for a more flexible brushing action; suitable for use on smooth or threaded blind holes.



Diameter	Wire Size	Brush Part	Stem Diameter	Overall Length	Standard Pack	Item Number
						Brass
1/4"	.004	1"	1/8"	3-1/2"	10	21332
1/2"	.005	1"	3/16"	3-1/2"	10	21182
1-1/2"	.008	1"	1/4"	3-1/2"	10	21152



21332

**P** **SINGLE STEM, SINGLE SPIRAL HAND TUBE BRUSHES** - Constructed using a single continuous length of galvanized steel stem wire and feature a formed eye loop for convenient hand use. The single spiral of straight wire fill allows for easy manual insertion into the ID.

Diameter	Wire Size	Brush Part	Stem Diameter	Overall Length	Standard Pack	Item Number
						Brass
3/16"	.003	1-1/2"	3/32"	7"	10	21221
1/4"	.003	1-1/2"	3/32"	7"	10	21270
						21139
3/8"	.004	2"	1/8"	8"	10	21191
1/2"	.004	2"	1/8"	8"	10	21165



21191

# STRIP BRUSHES



Straight strip brush used as a guard to prevent chips from flying.

**METAL CHANNEL STRIP BRUSHES** consist of natural, synthetic or wire bristles, held securely in place by a U-shaped metal channel and center wire, as illustrated. All Weiler brushes are first manufactured into a straight strip brush. The strip can then be coiled into cylinder brushes, or other shapes such as discs and cups. There are a variety of brush fills and virtually an infinite number of brush specifications within each metal channel size. All strip brushes are manufactured to our customers' individual requirements. This provides the proper filament stiffness, and allows for customers' unique modification of length and trim, enabling us to provide the ideal brush for the application.

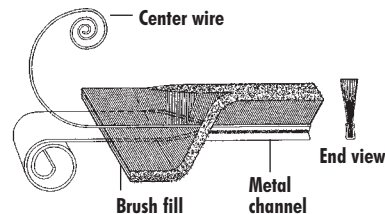

## APPLICATIONS

- Spreading powdered materials
- Dusting tires, tile, paper, etc.
- Splash guard on grinders and machine tools
- Conveyor belt cleaning - assembled on hubs to form rotary brushes
- Lag brushes
- Eliminating static electricity
- Curtains to prevent chips from flying



## GENERAL FIBER CHARACTERISTICS

Characteristic	6.6 Nylon	6.12 Nylon	Polypropylene	Horse Hair	Tampico
Heat Distortion (°F)	300	250	225	370	283
Melting Point	500	405	330	—	—
Bend Recovery (%)	90	90	70-80	excellent	poor
Shelf Life	excellent	excellent	good	poor	fair
Abrasion Resistance	excellent	excellent	good	good	poor
Specific Gravity (G/CC)	1.13-4	1.04-5	.90-1	1.3	.6
Tensile Strength (PSI)	60-70M	50-60M	50-80M	—	—

## CHEMICAL AND ENVIRONMENTAL RESISTANCE

Characteristic	6.6 Nylon	6.12 Nylon	Polypropylene	Horse Hair	Tampico
Dilute Alkali	excellent	excellent	excellent	poor	good
Dilute Acids	good	good	excellent	poor	good
Strong Acids	fair	good	good	good-poor	good-poor
Alcohols	good	good	excellent	poor	good
Petroleum Distillates	excellent	excellent	good	poor	good
Hot Water	good	good	fair	poor	good
Alcohols, Vegetable Oils	good	good	excellent	poor	good



# STRIP BRUSHES - STRAIGHT

Can be mounted on metal or wood back-up plates or on rotary hubs with machine or wood screws.



## FILL MATERIALS

- Hair (horse, goat, etc.)
- Carbon steel
- Type 302 stainless steel
- Non-ferrous metals (brass, bronze, etc.)
- Nylon abrasive filament (Nylox®)
- Natural fibers (tampico)
- Synthetics (nylon, polypropylene)

## STRIP BRUSHES - STRAIGHT

Metal Channel Size	Before Forming	After Forming (width x height)	Channel Materials			Max. OAH	Max. Bristle Diameter (nylon)	Max. Bristle Diameter (wire)
			Galvanized Steel	Stainless Steel				
				400 Series	300 Series			
#2.5	5/16" x .025	1/8 (.125) x 1/8" (.125)	XXX	XXX	—	1-1/2"	.012	.006*
#3	3/8" x .025	5/32" (.156) x 5/32" (.156)	XXX	XXX	—	3-1/2**	.014	.006*
#4	1/2" x .030	3/16" (.187) x 3/16" (.187)	XXX	XXX	XXX	4"	.025	.008
#5	5/8" X .040	7/32" (.218) X 1/4" (.250)	XXX	XXX	—	4-1/2"	.030	.008
#7	7/8" X .040	5/16" (.312) X 5/16" (.312)	XXX	XXX	XXX	6"	.050	.020
#10	1-1/4" X .050	7/16" (.437) X 7/16" (.437)	XXX	XXX	—	6"	.060	.020

\* Available in brass or bronze only.

\*\* Max. wire OAH 1-1/2".

## STRAIGHT STRIP BRUSHES SPECIFICATIONS:

(Use the illustration on this page as a guide)

1. Overall brush height: \_\_\_\_\_
2. Overall brush length: \_\_\_\_\_
3. Channel size:
  - #2.5       #3       #4
  - #5       #7       #10
4. Channel material:     Galvanized Steel     Stainless Steel
5. Brush fill material:
  - Horsehair               Nylon               Carbon Steel               Bronze
  - Polypropylene         Brass               302 Stainless               Tampico
  - Nylon Abrasive Filament (Nylox)     Other \_\_\_\_\_
6. Fill material:  Crimped     Straight  
 Diameter: \_\_\_\_\_ Color (if applicable): \_\_\_\_\_
7. Application:     Wet       Dry      Operating Temp.: \_\_\_\_\_ °F
8. Quantity required: \_\_\_\_\_

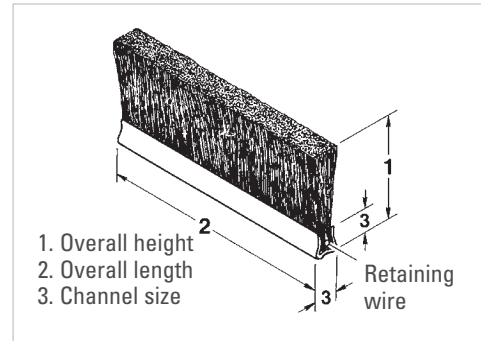

\* Strip brushes are not returnable, as they are manufactured to order.

Name: \_\_\_\_\_  
 Company Name: \_\_\_\_\_  
 Address: \_\_\_\_\_  
 Phone: (\_\_\_\_\_) \_\_\_\_\_  
 Fax: (\_\_\_\_\_) \_\_\_\_\_  
 E-mail: \_\_\_\_\_

End-User Name: \_\_\_\_\_  
 City: \_\_\_\_\_  
 State: \_\_\_\_\_ Zip: \_\_\_\_\_

## FOR ADDITIONAL INFORMATION CALL:

Weiler's Application Engineering  
 Hotline toll free at:  
 888-299-APPS (2777)

## FAX SPECIFICATION SHEET TO:

Application Engineering  
 Fax: 800-635-3615

# STRIP BRUSHES - COIL WOUND

Can be supplied as an unmounted refill coil, mounted on disposable tubing or wound on a customer's shaft.



## FILL MATERIALS

- Hair (horse, goat, etc.)
- Carbon steel
- Type 302 stainless steel
- Non-ferrous metals (brass, bronze, etc.)
- Nylon abrasive filament (Nylox®)
- Natural fibers (tampico)
- Synthetics (nylon, polypropylene)

**ALLIGATOR CLIPS** - Use on #7 channel only. Coil Wound Strip Brushes can be supplied with alligator clips that have tabs at each end to be attached to customers' mandrel.



## STRIP BRUSHES - COIL WOUND

Metal Channel Size	Before Forming	After Forming (width x height)	Channel Materials			Min. I.D.	Max. O.D.	Max. Bristle Dia. (nylon)	Max. Bristle Dia. (wire)
			Galvanized Steel	Stainless Steel					
				400 Seres	300 Seres				
#2.5	5/16" x .025	1/8 (.125) x 1/8" (.125)	XXX	XXX	-	3/8"	3-3/8"	.012	.006*
#3	3/8" x .025	5/32" (.156) x 5/32" (.156)	XXX	XXX	-	3/8"	7"	.014	.006*
#4	1/2" x .030	3/16" (.187) x 3/16" (.187)	XXX	XXX	XXX	1/2"	7"	.025	.008
#7	7/8" X .040	5/16" (.312) X 5/16" (.312)	XXX	XXX	XXX	1"	11"	.050	.020

\* Available in brass or bronze only.

## COIL WOUND STRIP BRUSHES SPECIFICATIONS:

(Use the illustration on this page as a guide)

1. Outside diameter size \_\_\_\_\_
2. Inside diameter size \_\_\_\_\_
3. Brush face \_\_\_\_\_
4. Channel size:
  - #2.5     #3     #4     #7
5. Channel material:     Galvanized Steel     Stainless Steel
6. Brush fill material:
  - Horsehair                       Nylon                       Carbon Steel     Bronze
  - Polypropylene                   Brass                       302 Stainless     Tampico
  - Nylon Abrasive Filament (Nylox)     Other \_\_\_\_\_
7. Fill material:  Crimped     Straight  
Diameter: \_\_\_\_\_ Color (if applicable): \_\_\_\_\_
8.  Close wound     Open wound    Specify pitch between spirals \_\_\_\_\_
9. Mounting Clips:     Yes     No
10. Application:     Wet     Dry    Operating Temp.: \_\_\_\_\_°F
11. Quantity required: \_\_\_\_\_

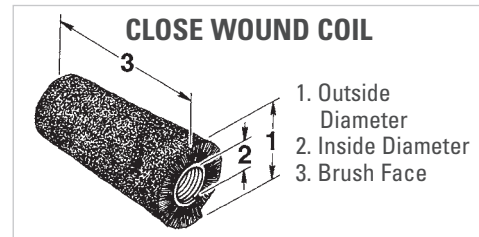
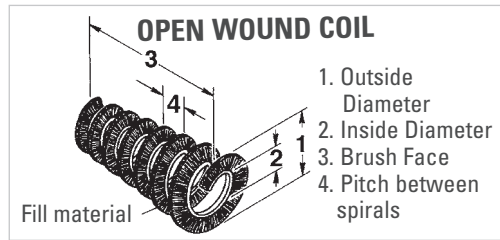

\* Strip brushes are not returnable, as they are manufactured to order.

Name: \_\_\_\_\_  
 Company Name: \_\_\_\_\_  
 Address: \_\_\_\_\_  
 Phone: (\_\_\_\_\_) \_\_\_\_\_  
 Fax: (\_\_\_\_\_) \_\_\_\_\_  
 E-mail: \_\_\_\_\_

End-User Name: \_\_\_\_\_  
 City: \_\_\_\_\_  
 State: \_\_\_\_\_ Zip: \_\_\_\_\_

**FOR ADDITIONAL INFORMATION CALL:**  
 Weiler's Application Engineering  
 Hotline toll free at:  
 888-299-APPS (2777)

**FAX SPECIFICATION SHEET TO:**  
 Application Engineering  
 Fax: 800-635-3615



## STRIP BRUSHES - DISC BRUSHES

**Outside Disc:** A circular single loop brush with the bristles facing OUTWARD, and the metal channel on the inside.

**Inside Disc:** A circular single loop brush with the bristles facing INWARD, and the metal channel on the outside.

## STRIP BRUSHES - FORMED CUPS

These strip brushes are formed into a circle with the bristles facing down, commonly found in vacuum cleaning applications.



### HOLDERS FOR METAL CHANNEL SIZE #2.5

Max. length 12'

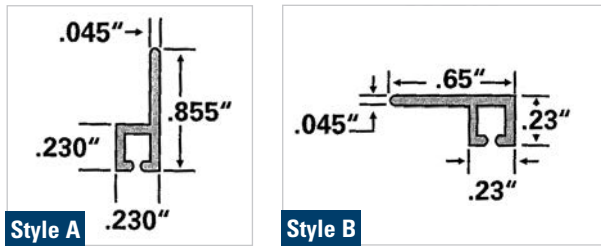

### HOLDERS FOR METAL CHANNEL SIZE #4

Max. length 12'

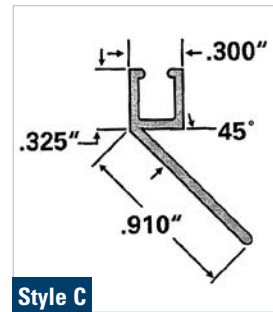
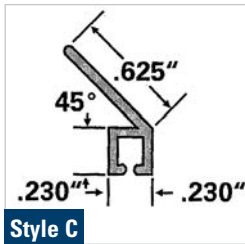
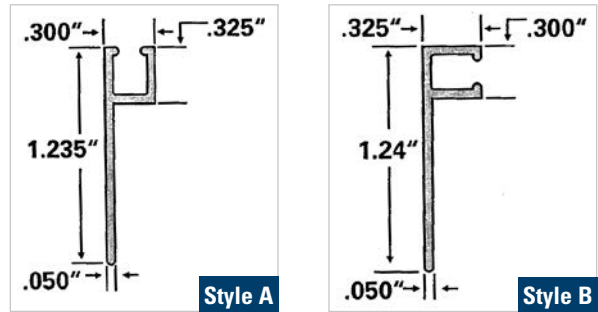

### HOLDERS FOR METAL CHANNEL SIZE #7

Max. length 12'

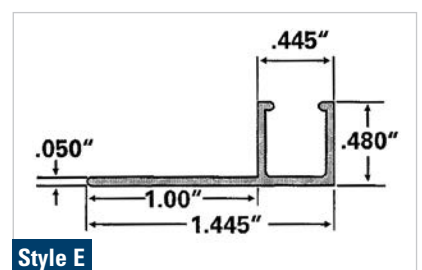
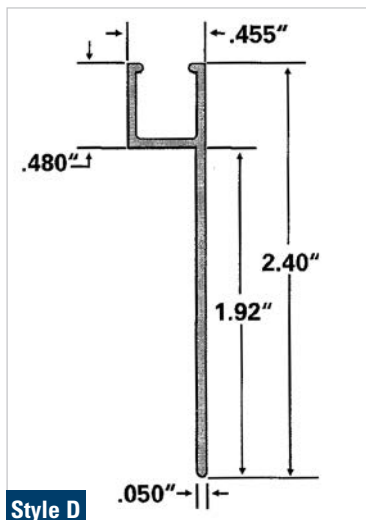
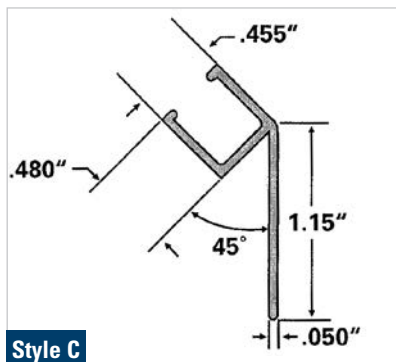
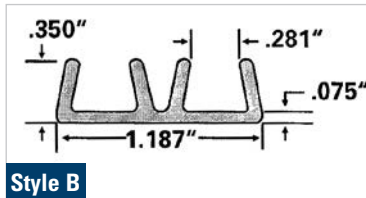
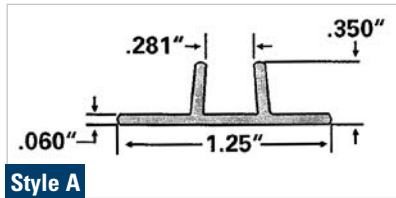

## NOTE

All holder styles are constructed of aluminum



# WIDE FACE BRUSHES



Removing light corrosion and mill scale from coiled steel.



Cylindrical brush assemblies have proven to be reliable and economical tools for a wide variety of industrial surface conditioning applications. In addition to gang-mounting a series of individual wheel brushes onto a shaft or reusable arbor, one-piece wide face brush units can be manufactured to cover broad surfaces or provide maximum brushing action in a minimum amount of space.

Cylindrical brushes can be manufactured using several different styles of construction, and the characteristics of each style of construction can significantly affect brush performance. Weiler will custom-design a wide face brush in the most appropriate type of construction for your specific application. Please call our Application Engineering Team at 888-299-APPS (2777) to discuss your requirements.

## APPLICATIONS

- Scrubbing debris from the surface of material during processing
- Removing corrosion, surface contamination, mill scale, or heat discoloration
- Roughening surfaces to promote adhesion or bonding
- Removing applied finishes and coatings
- Producing decorative surface finishes
- Deburring or finishing cylindrical parts
- Deburring the cut ends of tubing and extrusions

**DISPOSABLE BRUSH ASSEMBLIES** - Wide face assemblies for brushing flat surfaces can be manufactured as disposable units with a variety of available fill materials depending on the specific application. Available fills include; metallic filaments such as steel, stainless steel, or brass crimped wire; Nylox® nylon abrasive filaments; synthetic filaments such as nylon or heat-stabilized polypropylene; or natural fibers such as tampico.

Disposable mountings can be constructed of carbon steel or stainless steel components, and “flow-through” mountings which allow coolant to be circulated through the core and out the face of the brush are available for wet applications.

**REFILLABLE BRUSH ASSEMBLIES** - Wide face assemblies for brushing flat surfaces can also be manufactured as a replaceable brush unit wound onto a permanent and reusable arbor. Depending on the specific application and production environment, refilling reusable arbors may be a more economical option than using disposable units. Reusable mountings can be designed by Weiler or supplied by the customer.

In addition to the secondary operations such as nibbling and grinding of the brush face and dynamic balancing of the completed unit, Weiler also offers maintenance services on mounting hardware like collars and bearings.

**TUBE END DEBURRING BRUSHES** - Cylindrical rotary brushes are an ideal media for production applications involving the batch deburring of the ends of tubing that has been cut-to-length. Automated brushing systems are readily available and considerably less expensive to purchase and operate than chamfering machines.

Brush deburring machines can be integrated with cut-off operations to eliminate work-in-process and increase throughput, and they are flexible enough to be quickly adjusted for various shapes, sizes, and lengths of tubing. Unlike chamfering operations, brush deburring does not leave secondary burrs, brushing equipment is more tolerant of slight variations in machine set-up and tube length, and quality brushes last much longer than cutting inserts on double-end finishers.

Tube end deburring brushes are most commonly manufactured as disposable assemblies that are then mounted onto keyed shafts. High-tensile steel, hard-drawn steel, and Type 302 stainless steel wire are the most common fill materials used in tube end deburring brushes. Weiler offers high quality brushes with wire sizes from .006 to .020 and four available levels of fill density so that the brushing performance can be tailored to the material, burr condition, and budget of the end-user.

**CUSTOM TUBE END DEBURRING BRUSHES** - Please use the appropriate specification sheet on the next page when requesting a quotation on a custom tube end deburring brush.

## NEED HELP?

Call our Application Engineering Hotline at 888-299-APPS (2777). If the problem is too complex to be solved over the phone, we will determine if an evaluation should be conducted at our in-house lab or your facility. Either way, Weiler will provide the most cost-effective solution for your specific application.

## BRUSH-TUBE ORIENTATION

Brush-tube orientation determines which edges of the tube are deburred. The illustrations below show three orientations and the target edge.

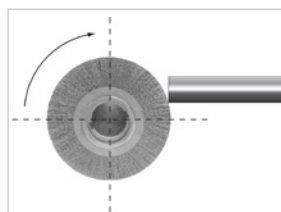

Deburring Tube I.D.

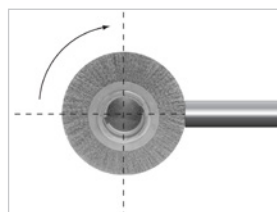

Deburring Tube I.D. and O.D.

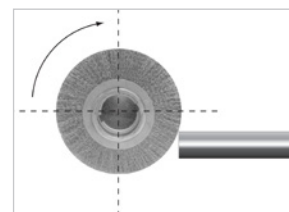

Deburring Tube O.D.

# WIDE FACE BRUSH SPECIFICATION SHEET:

To help us accurately quote a wide face brush for your application, please provide the following information:

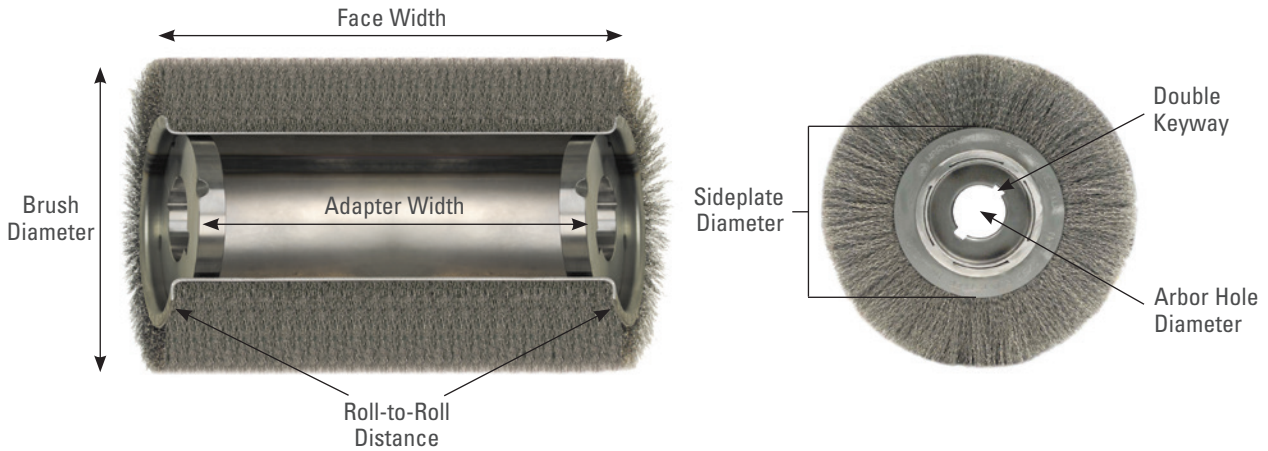

\_\_\_\_\_ Brush Diameter (Note: Tolerance is +/- 1/16")

\_\_\_\_\_ Fill Material \_\_\_\_\_ Fill Diameter

Fill Density:  Economy  General Purpose  Heavy-Duty  High Performance

\_\_\_\_\_ Face Width (Note: Tolerance is +/- 1/4")

\_\_\_\_\_ Roll-to-Roll Distance - Through Arbor Dimension (Note: Tolerance is +/- 1/8")

Brush can be manufactured holding the face width dimension or the roll-to-roll distance, not both.

\_\_\_\_\_ Sideplate Diameter

Standard sizes:

6" brush = 3-3/4" O.D.

8" brush = 5-1/4", 5-1/2" or 6-1/2" O.D.

>8" brush = 5-1/2" or 6-1/2" O.D.

\_\_\_\_\_ Maximum Operating RPM

\_\_\_\_\_ Adapter Width (Note: Adapters are 1/2" thick, tolerance on width spacing is +/- 1/8")

\_\_\_\_\_ Arbor Hole Diameter (Note: Clearance of 0.003" with additional tolerance of + 0.004" - 0 will be added)

Keyway(s) Required  Single  Double Keyway Width \_\_\_\_\_ Keyway Depth \_\_\_\_\_

Intended Brush Use: \_\_\_\_\_

Name: \_\_\_\_\_

End-User Name: \_\_\_\_\_

Company Name: \_\_\_\_\_

City: \_\_\_\_\_

Address: \_\_\_\_\_

State: \_\_\_\_\_ Zip: \_\_\_\_\_

Phone: (\_\_\_\_\_) \_\_\_\_\_

Fax: (\_\_\_\_\_) \_\_\_\_\_

E-mail: \_\_\_\_\_

## FOR ADDITIONAL INFORMATION CALL:

Weiler's Application Engineering  
Hotline toll free at:  
888-299-APPS (2777)

## FAX SPECIFICATION SHEET TO:

Application Engineering  
Fax: 800-635-3615



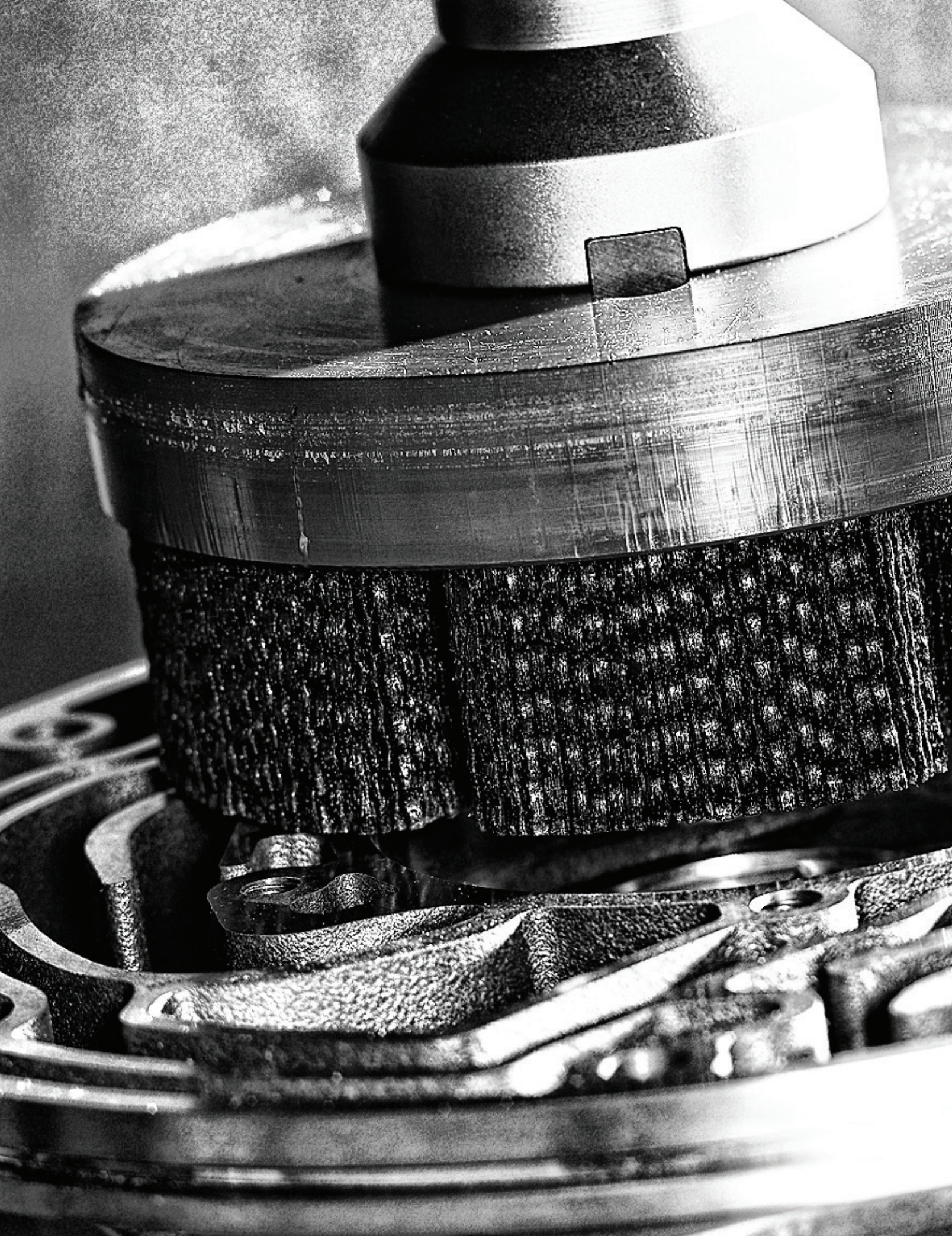



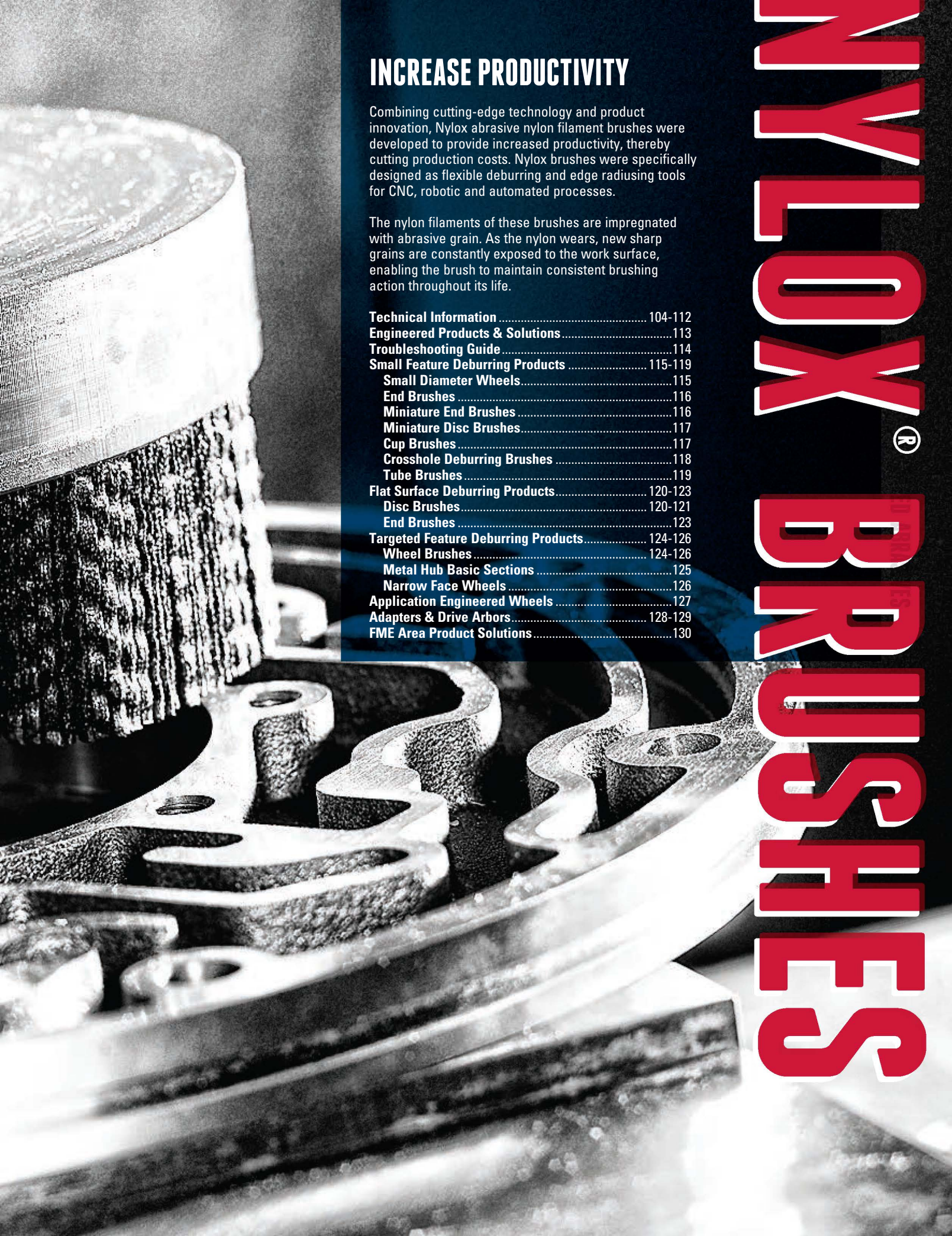

## INCREASE PRODUCTIVITY

Combining cutting-edge technology and product innovation, Nylox abrasive nylon filament brushes were developed to provide increased productivity, thereby cutting production costs. Nylox brushes were specifically designed as flexible deburring and edge radiusing tools for CNC, robotic and automated processes.

The nylon filaments of these brushes are impregnated with abrasive grain. As the nylon wears, new sharp grains are constantly exposed to the work surface, enabling the brush to maintain consistent brushing action throughout its life.

<b>Technical Information</b> .....	104-112
<b>Engineered Products &amp; Solutions</b> .....	113
<b>Troubleshooting Guide</b> .....	114
<b>Small Feature Deburring Products</b> .....	115-119
<b>Small Diameter Wheels</b> .....	115
<b>End Brushes</b> .....	116
<b>Miniature End Brushes</b> .....	116
<b>Miniature Disc Brushes</b> .....	117
<b>Cup Brushes</b> .....	117
<b>Crosshole Deburring Brushes</b> .....	118
<b>Tube Brushes</b> .....	119
<b>Flat Surface Deburring Products</b> .....	120-123
<b>Disc Brushes</b> .....	120-121
<b>End Brushes</b> .....	123
<b>Targeted Feature Deburring Products</b> .....	124-126
<b>Wheel Brushes</b> .....	124-126
<b>Metal Hub Basic Sections</b> .....	125
<b>Narrow Face Wheels</b> .....	126
<b>Application Engineered Wheels</b> .....	127
<b>Adapters &amp; Drive Arbors</b> .....	128-129
<b>FME Area Product Solutions</b> .....	130

# MYLLOK<sup>®</sup> BRUSHES



# SOLUTIONS SHOWCASE

## TRANSMISSION VALVE BODY

**Problem:** Burrs on transmission components can break away from parent components during use and cause transmission wear and eventual failure. Therefore, fluid passages must be completely burr-free.

**Solution:** A 10" Nylox® disc brush operating at 825 RPM in a vertical CNC machining center is an ideal solution for deburring this component. Since all of the burrs are on a single plane, the non-directional nature of a Nylox disc brush produces a part on which all edges have been uniformly deburred.

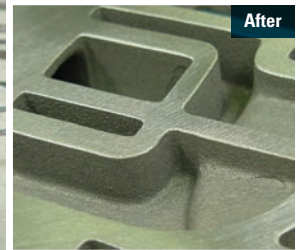
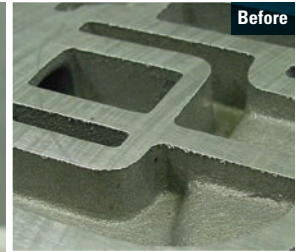
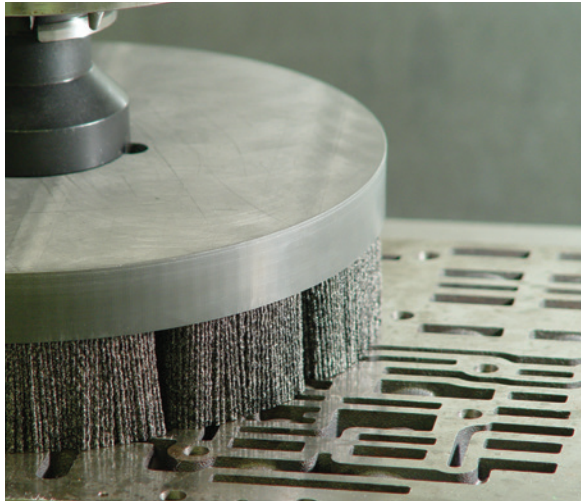

## STEERING COMPONENT

**Problem:** Manual deburring can be costly in many respects. Hard deburring tools and aggressive abrasive wheels do not allow much margin for operator error and the result is often high scrap rates.

**Solution:** Nylox brushes produce a flexible filing action that concentrates all of the abrasive cutting action on sharp edges, giving them the ability to remove burrs without altering overall part dimensions. For example, a 6" Burr-Rx® wheel mounted onto a 1,725 RPM pedestal buffer is capable of deburring this steering component just as quickly as a convolute wheel but without the fear of over-radiusing the edges of the teeth or producing flat spots.

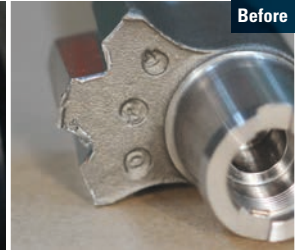
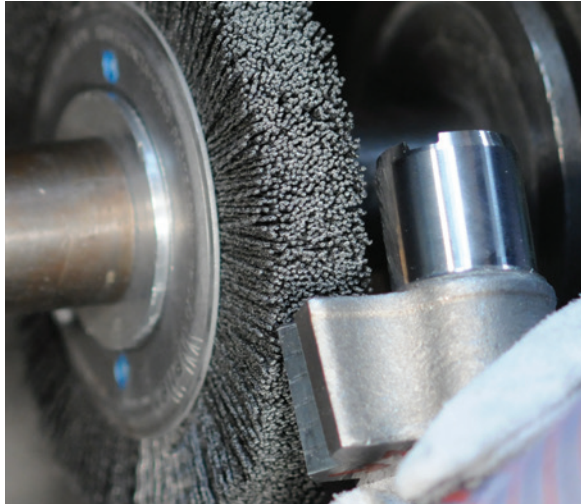

## TOOL STEEL DEBURRING

**Problem:** Traditional nylon abrasive brushes were not sufficiently aggressive to remove large burrs from materials like tool steels and stainless steels.

**Solution:** Weiler's next generation filament technology, embodied in the company's line of Burr-Rx brushes, creates sufficient aggression to handle the toughest deburring jobs. This enables more users to capture the benefits offered by in-machine deburring.

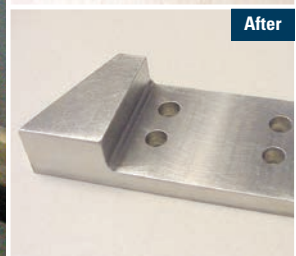
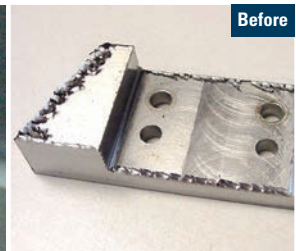
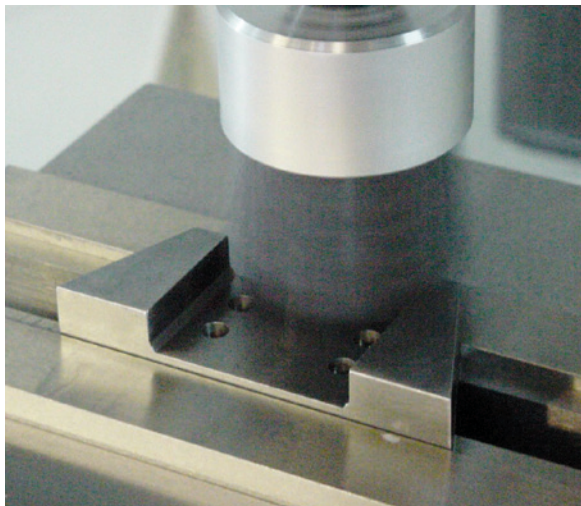

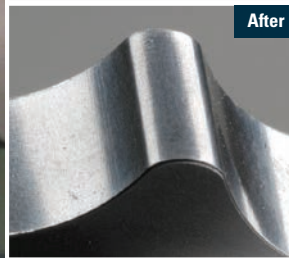
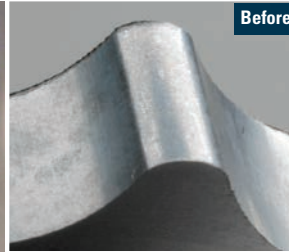
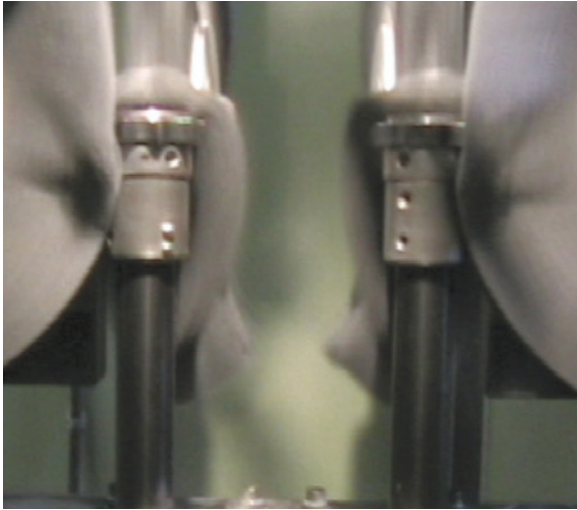

## PUMP GEAR

**Problem:** Pumps are extremely susceptible to failure due to burrs. Due to the tight fit between components, all edges must be deburred and radiused to ensure proper function. Proper deburring of rotating pump gears is especially important.

**Solution:** A dedicated machine running 14" Nylox® wheel brushes at 900 RPM was a low-cost solution for deburring these gears. By using dedicated equipment, cycle time was minimized and an acceptable edge condition was achieved.

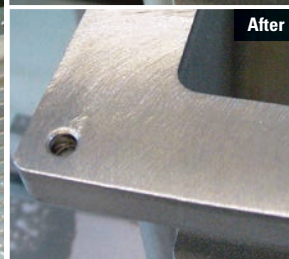
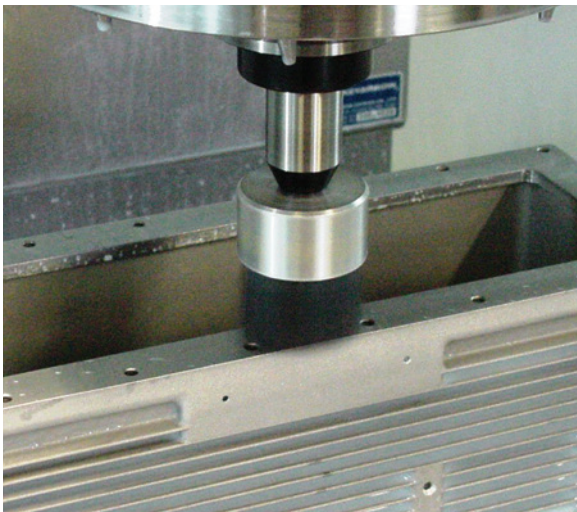

## CAST ALUMINUM HOUSING

**Problem:** Although deburring the face-milled surfaces of castings is a very straight forward application for Nylox disc brushes, the limited availability of valuable machine time can be a perceived obstacle that prevents users from reaping the many benefits of implementing in-machine deburring operations.

**Solution:** The advanced ceramic grain technology of Weiler's Burr-Rx® tools offer a deburring action that is up to 400% greater than traditional abrasive nylon brushes that contain silicon carbide or aluminum oxide filaments. This allows Burr-Rx deburring tools to be used at feed rates that dramatically reduce the amount of additional machine time required to perform a brushing operation.

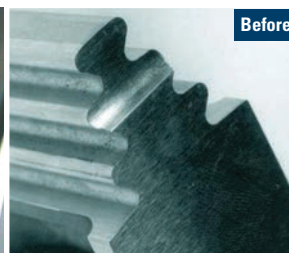
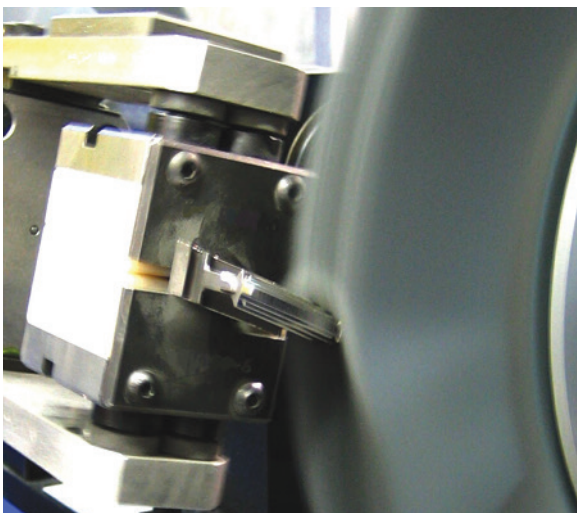

## TURBINE BLADE

**Problem:** Protecting turbine engine components against high-temperature fatigue is critical to ensure safe, reliable engine operation. Component edges must be burr-free and generally require an edge radius in the range of 0.005" to 0.060".

**Solution:** Robots are extremely well-suited for this application because they can manipulate the component in many orientations in relation to the brush. Weiler works closely with users and robot integrators to develop products and process programs that maximize brush life while generating exceptional part quality and consistency.

Photo courtesy of ACME Manufacturing.



# SELECTING THE RIGHT BRUSH



## WHERE TO START?

Sometimes it's necessary to design and manufacture a unique, custom-tailored product to meet your application requirements. Although Weiler offers such engineered solutions in all of our product lines, the innovative construction and value-added nature of the Nylox® line of nylon abrasive filament brushes showcases the creativity and expertise of our Application Engineering Team in designing products that have been tailored to the needs of the customer.

- Custom-engineered Nylox brushes can be designed and manufactured as variations on our standard products.
- Wide face brush assemblies for finishing flat surfaces or deburring cylindrical parts can also be designed and manufactured using Nylox nylon abrasive filaments. (See pages 100-101 for more information)

### FOR SOLUTIONS TO DIFFICULT APPLICATIONS

Call our Application Engineering Hotline at 888-299-APPS (2777).

If the problem is too complex to be solved over the phone, we will determine if an evaluation should be conducted at our in-house lab or the user's facility.

## TRIM LENGTH AND FILL DENSITY

To maximize brush life and reduce costs, always use the shortest trim, highest density brush that will adequately conform to the surface or part edges.

### LONG TRIM, LOW DENSITY

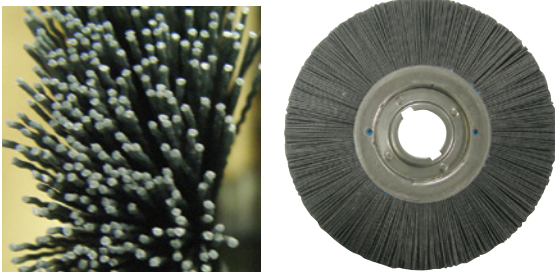

These brushes offer a greater degree of flexibility that is ideal for applications requiring a high degree of brush conformability. However, the lower fill density can result in shorter brush life and less consistent performance.

### SHORT TRIM, HIGH DENSITY



These brushes work with a faster action and less engagement with the brush face. This produces shorter cycle times, more consistent performance and longer life in applications that do not require a high degree of brush conformability.

## GRIT SIZE COLORS

Grit size is indicated by a dot on the product with the following colors:

<b>Black</b> 46 Grit	<b>Green</b> 120 Grit	<b>Gold</b> 200 Grit	<b>Purple</b> 600 Grit
<b>Red</b> 60 Grit	<b>Grey</b> 180 Grit	<b>White</b> 320 Grit	<b>Blue</b> 1000 Grit
<b>Yellow</b> 80 Grit	<b>Orange</b> 240 Grit	<b>Brown</b> 500 Grit	<b>Lt. Blue</b> 800 Grit
			<b>Pink</b> 1200 Grit

# PRODUCT ADVANTAGES

## PRODUCT ADVANTAGES

### AGGRESSIVE YET COMPLIANT



- Nylox® brushes do not alter the overall dimensions or geometry of a part.
- Filament compliance allows these brushes to conform to complex part shapes and reduces the need for ultra-precise programming and fixturing.

### IDEAL FOR AUTOMATION



- Abrasive grain is evenly distributed throughout the nylon filament.
- Extremely consistent performance throughout their product life.
- Ideal media for use in automated deburring and finishing processes.
- Ideal for dedicated production equipment or robotic cells.
- Can be directly integrated into the cycle of CNC machining centers.
- Improve part quality and consistency.
- Reduce direct labor cost.

### IDEAL FOR DEBURRING

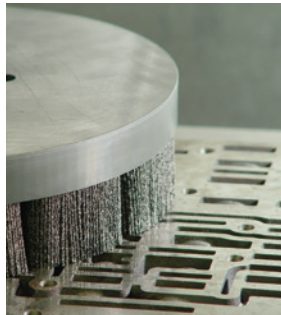

- Nylox filaments act like flexible files, deburring and radiusing edges as they wipe across them.
- Their limited aggression and flexible filing action also make them suitable for deburring a wider range of materials in comparison to wire-filled power brushes.

### ENHANCED SURFACE FINISHES



- The compliant cutting action not only limits their ability to alter part dimensions, but it makes them an effective tool for refining surface texture characteristics without removing significant amounts of base material.
- Although they contain the same abrasive grain sizes, Nylox brushes will not generate the same prominent scratch pattern as a comparable coated abrasive product.

## CONSTRUCTION ADVANTAGES

### COMPETITOR'S METAL HUB

- Metal hub components are assembled under high pressure, potentially damaging the filaments and causing premature breakage.
- Retaining ring displaces filament material, creating a void in the center of the brush face.
- Lower fill density can result in shorter life and less consistent performance.



### WEILER'S COMPOSITE HUB

- Molded hub construction eliminates filament breakage.
- Uniform distribution of fill material and superior balance.
- Higher fill density provides more aggressive brushing and longer life.
- Consistent performance as the brush wears.



### WEILER'S COMPOSITE METAL HUB

- Filaments retained using the latest polymer technology to prevent filament breakage.
- Metal components add impact resistance and dimensional stability.
- The highest filament density in the market ensures lowest cost-per-part.



### WEILER'S PVC SHELL MILL

The PVC construction results in a very consistent, flat brush face. Their high dimensional precision makes them suitable for the most critical applications. They perform more consistently from the first part to the last.



### WEILER'S TUFTED FILAMENTS

This construction style offers increased aggression due to added filament density. This enables processing of severe burrs or generating larger edge radii in shorter cycle times. The longer trim length allows for greater conformability and longer life.

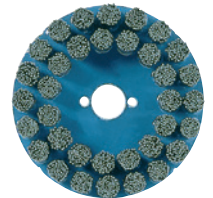

### WEILER'S MAXIMUM DENSITY

Maximum density brushes are uniquely suited for demanding applications characterized by large burrs and rapid feed rates.



WHY WEILER

BONDED ABRASIVES

COATED ABRASIVES

NON-WOVEN ABRASIVES

POWER BRUSHES

NYLOX BRUSHES

PACKAGED ITEMS

MAINTENANCE

# PRODUCT CHARACTERISTICS

## WHEEL BRUSHES



- Precision deburring of component parts after machining or grinding.
- Improving surface texture on machined or ground surfaces.
- Honing cutting tools and generating specific edge profiles and radii.
- Light duty cleaning and finishing of metals; light sanding of woods and composites.

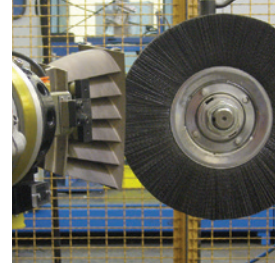

## DISC BRUSHES

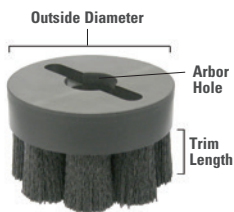

- Deburring flat surfaces on machined components.
- Improving texture on machined or ground surfaces.
- Deburring face-milled castings or forgings.
- Blending tool marks after machining or grinding.

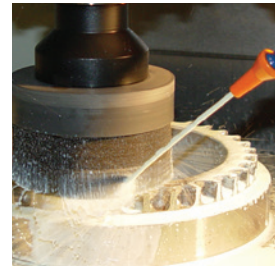

## END BRUSHES

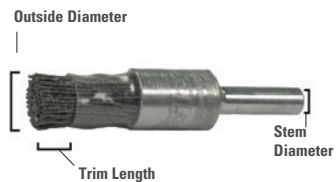

- Deburring flat surfaces on machined components.
- Improving texture on machined or ground surfaces.
- Deburring face-milled castings or forgings.
- Blending tool marks after machining or grinding.

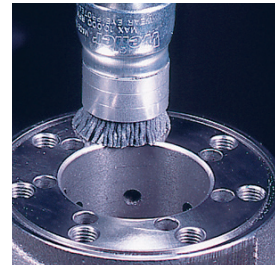

## TUBE BRUSHES

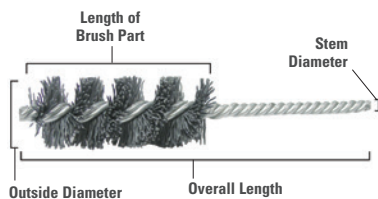

- Deburring and finishing applications in tubular component parts, drilled and tapered holes and machined bores and passages.



## CROSSHOLE DEBURRING BRUSHES



- Deburring internal edges.
- Improving surface texture on internal bores.

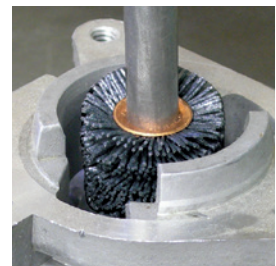



## FILAMENT CONFIGURATIONS

**ROUND FILAMENTS** - Due to their cross-sectional shape and the reduced contact with the work surface or part edges that result, round filaments provide a more compliant brushing action for less aggression and enhanced conformability.

**RECTANGULAR FILAMENTS** - Due to their shape, larger cross-sectional area and increased contact with the work, rectangular filaments provide a less compliant brushing action for much greater aggression and reduced conformability.

*Crimping either type of filament along its length enhances conformability, allowing greater penetration of part edges into the brush face, often increases aggression. Crimped filaments are especially beneficial in maximum density disc brush designs.*

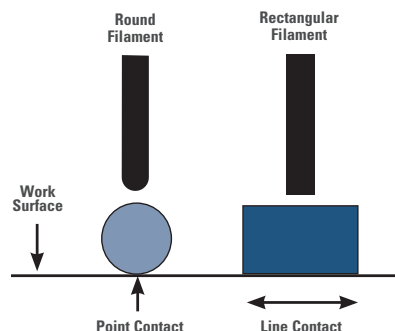

## ABRASIVE FILAMENTS

Abrasive brush filaments are manufactured by extruding a mixture of liquefied polymer and abrasive grain. Unlike the filaments used in DIY grade abrasive brushes, industrial grade products like Weiler's Nylox® and Burr-Rx® brushes feature the highest grade of abrasive filament manufactured using a Type 6.12 nylon polymer. Industrial grade filaments also feature the highest quality abrasive materials that have been sifted and sorted to ensure that the grains are consistent in size. These grains may be one of four different types of abrasive:

- **ALUMINUM OXIDE (AO)** - is a duller, less aggressive grain typically used in finishing applications requiring a less pronounced scratch line pattern or deburring applications on materials where the use of SiC may be prohibited
- **BURR-RX CERAMIC (CG)** is an engineered abrasive grain that produces a superior cutting action and is compatible with the widest range of materials. It is the most effective grain available today!
- **SILICON CARBIDE (SIC)** is a sharp-edged grain that produces an effective cutting action. It is the most common grain used in industrial grade brushes.
- **DIAMOND FILAMENT** is a sharp-edged grain typically used for producing edge radii on hard materials like diamond, ceramic, CBN and glass.

## ADVANTAGES OF BURR-RX CERAMIC

Nylox brushes containing the Burr-Rx black ceramic filament provide the following advantages over SiC and AO filaments.

- 400% greater cutting action
- Most cost-effective deburring brush
- Deburr tougher materials
- Minimize cycle time
- Maximize tool life
- Reduce finishing costs
- Eliminate hand deburring

### DEBURRING ACTION - BURR-RX (CG VS. SIC)

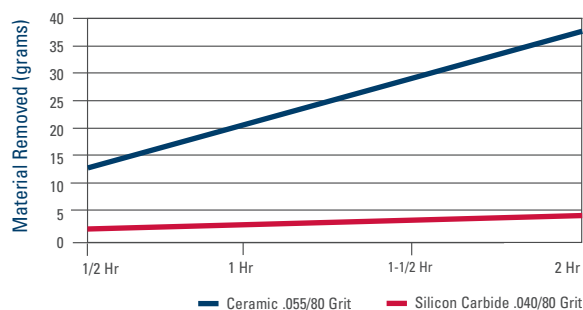

## WHEEL VS. DISC BRUSH

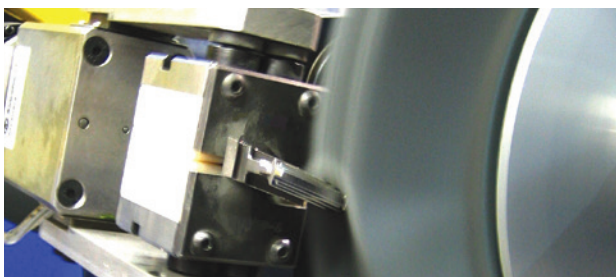

Nylox wheel brushes are for applications where a targeted brushing action is required.

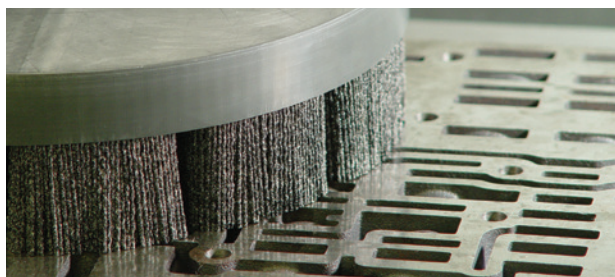

Disc brushes are for applications where the burrs lie along a single plane.

# OPERATING INFORMATION

## OPERATING PARAMETERS

Nylox® abrasive brushes work with a wiping and filing action. Think of them as flexible files. The sides of the Nylox filament actually do the work. To achieve a maximum edge radius and complete burr removal, parts should be buried into a slow running brush face. They work best when operated at speeds that allow

fairly deep penetration of the work-piece into the brush filaments. Usually, faster speeds do not work as well as slower speeds. The maximum RPM marked on the brush is not the optimum working speed. A good rule of thumb is to stay under 2,500 SFPM in dry applications and 3,500 SFPM in wet applications.

### WHEEL BRUSHES

#### PENETRATE 10% OF TRIM LENGTH



### DISC BRUSHES

#### 0.075" - 0.100" DEPTH OF INTERFERENCE

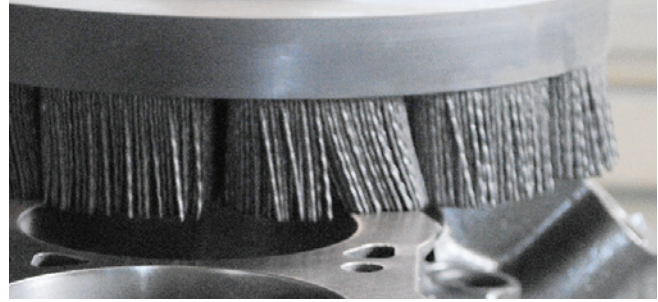

### OPERATING SPEEDS - WHEEL BRUSHES

Diameter	RPM
2"	3,450 - 5,000
3"	2,500 - 3,450
4"	1,750 - 2,500
6"	1,350 - 1,750
8"	1,150 - 1,350
10"	950 - 1,150
12"	750 - 950
14"	650 - 850

### OPERATING SPEEDS - DISC BRUSHES

Diameter	RPM
1-3/4" & 2"	1,750 - 2,000
3"-4"	1,500 - 1,750
5" - 6"	1,250 - 1,500
8"	800 - 1,000
10"	700 - 800
12"	600 - 700
14"	500 - 600

**FEED RATE** is determined by the amount of deburring, edge radiusing or surface finishing required and the type of material that is being processed. It is generally application specific. Slower feeds result in a more aggressive brushing action. Based on the brushing action desired for a specific application, the feed rate can be increased or decreased.

Material	SiC and AO Grain Feed Rate	Burr-Rx Grain Feed Rate
Non-Ferrous	50 in./min.	80 in./min.
Cast Iron	30 in./min.	60 in./min.
Mild Steel and Ductile Iron	25 in./min.	50 in./min.
Stainless and Alloy Steels	15 in./min.	30 in./min.
Titanium and High Nickel Alloys	10 in./min.	30 in./min.

### RECOMMENDED MOTOR SIZES

Brush Diameter	Motor Size	RPM*
3"-4"	1/4 HP	3,450
6"	1/2 HP	1,725
8"	3/4 HP	1,725
10"	1 HP	1,140
12"	1 HP	1,140
14"	1-1/2 HP	900

Note: This chart is based on 1" brush face.

\* A variable-speed motor control may be required to achieve optimum operating RPM; see operating speed charts above.

### MINIMUM RECOMMENDED SPINDLE DIAMETER (from ANSI Standard B165.1)

Outside Dia. of Wheel Brush	Maximum Face Width of Wheel Brush	Minimum Outside Dia. of Spindle (Shaft)
2"	1/4"	1/4"
3"	3/4"	1/4"
3" (heavy-duty)	1"	3/8"
4"	1"	3/8"
6"	1-1/4"	1/2"
8"	1-1/4"	5/8"
10"	2"	3/4"
12"	3"	1"
14"	3"	1-1/4"
15"	3"	2"
16"	3"	2"

Note: These diameters are based on the wheel brush being mounted next to the supported end of the shaft rather than the unsupported end in order to minimize overhang.

# COOLANT & WEAR COMPENSATION

## COOLANTS

Nylox® brushes can be run dry, without coolants. However, certain deburring conditions such as higher speeds, material properties and greater depth of penetration can create excessive heat buildup, causing the nylon filaments to melt and smear on the work surface. If the speed or depth of penetration cannot be changed, coolants are recommended to overcome heat smear. Coolants will also help produce finer finishes.

## WEAR COMPENSATION

On dedicated equipment, it is possible to automate wear compensation by using electronic controls to monitor the load on drive motors and adjust the position of the brushing tool to maintain a relatively consistent amount of interference or pressure. Since this is typically not possible with standard CNC machine tools, there are three other possible methods of compensating for tool wear for “in-machine” implementations of Nylox brushes.

## AUTOMATIC INDEXING

Most CNC controllers allow tool wear compensation to be accomplished by programming a “macro” - routine to periodically adjust the position of the tool based upon the number of parts produced. Some experimentation may be required to determine the frequency and amount of adjustment that will result for most consistent performance and maximum brush life.

## PROBING

If the machining center has the capability to probe the face of the brush, this feature can be used to gauge the true position of the filament tips. Adjustments to the brush position can then be made to maintain a consistent amount of interference between the tool and the part.

## MANUAL

If the other methods cannot possibly be used, machine operators can adjust the brush position based on either statistical process control data or visual inspection of completed parts.

**THE IDEAL TOOL PATH** for a Nylox Disc brush is very similar to the path of the face mill that produced the burr. However, three differences exist:

- The rotation direction of the brush should be opposite of the cutting tool that created the burr.
- The length of the path must be longer than the part. Unlike a cutter path that can stop when the leading edge of the cutter reaches the end of the part, the tool path of a brush should continue until the trailing edge of the brush reaches the end of the part.
- The centerline of the brush may need to be off-set from the center of the part in order to maximize the number of filaments that strike the part at a perpendicular angle. This is especially important when the diameter of the brush is similar to the width of the part.

The part is deburred in the shortest cycle time with the lowest consumable cost-per-part.

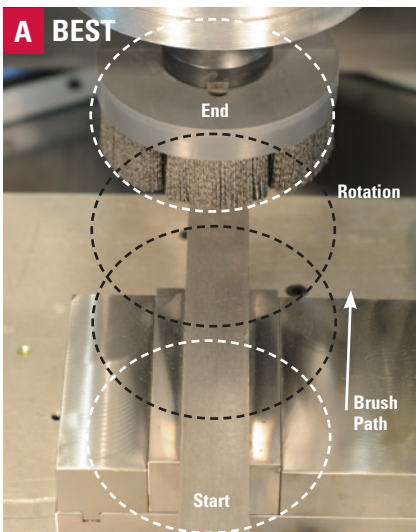

If a large diameter brush can be used, the centerline of the brush should be positioned on the center of the part. Ideally, the brush should be 3-4" wider than the part.

The part is deburred, but requires a longer cycle time. When a large brush will not fit in the tool changer, this method is recommended.

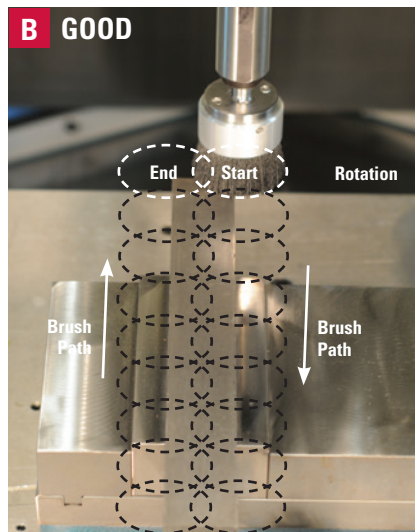

If a small diameter brush must be used, the centerline of the brush should be positioned on the edge of the part. This maximizes aggression by increasing the amount of perpendicular contact between the brush filaments and the burred edge.

Produces less deburring than A & B.

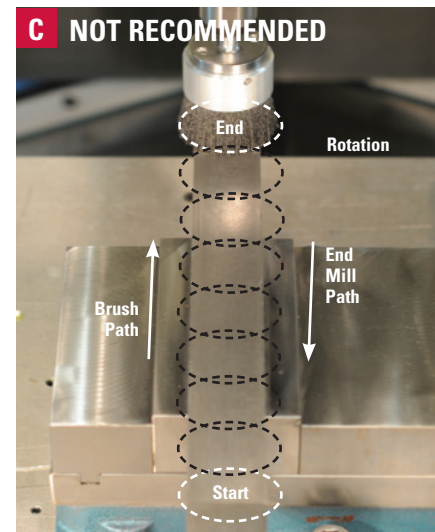

Positioning a small diameter brush with its centerline on the center of the part is not recommended. This configuration will not allow perpendicular contact of the filaments against the burred edge.



# COOLANT COMPATIBILITY

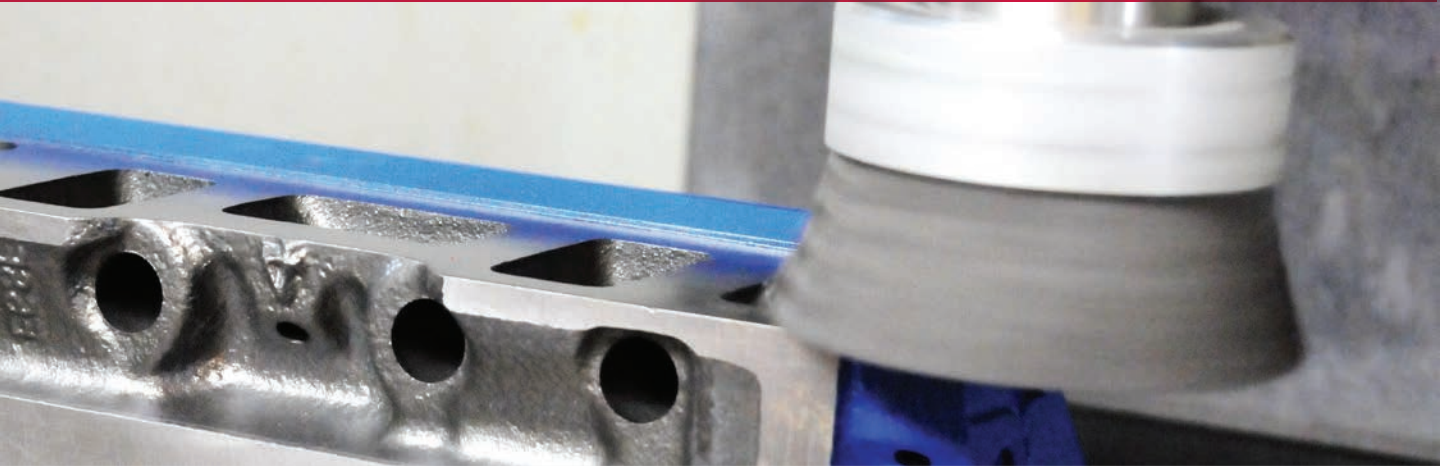

## NYLOX® BRUSHES IN AUTOMATED ENVIRONMENTS

**MYTH:** The abrasive grain in the Nylox brush will affect the accuracy of the equipment over time.

**FACT:** The abrasive grain in the Nylox brushes will not result in accelerated machine wear over time when used with proper filtration (50-micron or finer).

### Automotive Case Study

In the auto industry a five year study was conducted on the use of Weiler Nylox brushes with silicon carbide (SiC) grain in the manufacturing of aluminum intake and exhaust manifolds. Over the period of the study, there was no noticeable difference in way wear between machines that ran brushes and those that did not. A 50-micron coolant filter worked as specified to remove the residuals from the brushing process.

### Aerospace Case Study

A three year study was conducted on the use of Weiler Nylox brushes with ceramic grain (CG) in the manufacture of jet engine components. Over the period of the study, there was no loss in accuracy in the aerospace manufacturer's machines. A 50-micron coolant filter worked as specified to remove the residuals from the brushing process.



# ENGINEERED PRODUCTS AND CUSTOMIZED SOLUTIONS



Two members of our Application Engineering Team discuss the results after testing an engineered product.

## WE PROVIDE YOU WITH THE MOST COST-EFFECTIVE APPLICATION SOLUTIONS

Sometimes it is necessary to design and manufacture a unique, custom tailored product to meet your application requirements. Although Weiler offers such engineered solutions in all of our product lines, the innovative construction and value-added nature of the Nylox® line of nylon abrasive filament brushes showcases the creativity and expertise of our Application Engineering Team in designing products that have been tailored to the needs of the customer.

- Custom-engineered Nylox brushes can be designed and manufactured as variations on standard product configurations such as wheel, disc, cup, end, or tube brushes.
- Weiler's exclusive Burr-Rx® and Bore-Rx™ brushing tools can be engineered to meet the demands of a specific application.
- Wide face brush assemblies for applications such as finishing flat surfaces or deburring cylindrical parts can also be designed and manufactured using Nylox nylon abrasive filaments. (See pages 100-101 for more information)

## FOR SOLUTIONS TO DIFFICULT APPLICATIONS

Call our Application Engineering Hotline at 888-299-APPS (2777).

If the problem is too complex to be solved over the phone, we will determine if an evaluation should be conducted at our in-house lab or the user's facility.



# TROUBLESHOOTING GUIDE

There are many variables in Nylox® applications. If the Nylox brush you are using does not accomplish the desired results, select a solution from the suggestions below for your specific application or call Weiler's Application Engineering Hotline at 888-299-APPS (2777).

<b>Problem</b>	<b>Recommended Solutions</b>
Brush not aggressive enough	<ul style="list-style-type: none"><li>• Increase filament diameter and/or grit size</li><li>• Increase filament density by using round straight rather than round crimped</li><li>• Increase surface contact by using rectangular rather than round</li><li>• Increase pressure/depth of interference</li><li>• Increase surface speed by increasing spindle RPM</li><li>• Use a larger diameter brush</li><li>• Reduce trim length or feed rate</li></ul>
Brush too aggressive	<ul style="list-style-type: none"><li>• Reduce filament diameter and/or grit size</li><li>• Reduce filament density by using round crimped rather than round straight</li><li>• Reduce surface contact by using round rather than rectangular</li><li>• Reduce pressure/depth of interference</li><li>• Reduce surface speed by reducing spindle RPM</li><li>• Use a smaller diameter brush</li><li>• Increase trim length or feed rate</li></ul>
Brush not conformable enough	<ul style="list-style-type: none"><li>• Increase trim length</li><li>• Reduce filament diameter</li><li>• Reduce filament density by using round crimped rather than round straight or rectangular</li><li>• Reduce surface speed by reducing spindle RPM</li><li>• Reduce feed rate</li></ul>
Finer final finish required	<ul style="list-style-type: none"><li>• Increase surface speed by increasing spindle RPM</li><li>• Decrease grit size</li><li>• Use brush with a coolant</li></ul>
Coarser final finish required	<ul style="list-style-type: none"><li>• Reduce surface speed by reducing spindle RPM</li><li>• Increase grit size</li><li>• Use brush without a coolant</li></ul>
Filaments melt/smear on workpiece	<ul style="list-style-type: none"><li>• Reduce surface speed by reducing spindle RPM</li><li>• Use a smaller diameter brush</li><li>• Use brush with a coolant</li></ul>
Short brush life	<ul style="list-style-type: none"><li>• Increase filament density</li><li>• Reduce pressure/depth of interference</li></ul>

## NEED HELP?

Call our Application Engineering Hotline at 888-299-APPS (2777). If the problem is too complex to be solved over the phone, we will determine if an evaluation should be conducted at our in-house lab or your facility. Either way, Weiler will provide the most cost-effective solution for your specific application.



# SMALL FEATURE DEBURRING PRODUCTS

## SMALL DIAMETER WHEELS

Ideal for recesses and internal features or delivering targeted brushing action to a specific area. Our Burr-Rx® black ceramic grain filament wheels deliver up to a 400% greater edge-cutting action compared to traditional silicon carbide and aluminum oxide filaments for the fastest, most aggressive action for minimum cycle times and maximum life.

### APPLICATIONS

- Deburring keyways, slots and crosshole intersections
- Honing and finishing of cylindrical bores

### BURR-RX® SMALL DIAMETER WHEELS - Metal Hub - Crimped Round Black Ceramic Filament

Diameter	Filament Dia./Grit	Arbor Hole	Face Width	Trim Length	Max. RPM	Standard Pack	Item Number
1-1/4"	.026/120	1/4"	5/16"	5/16"	10,000	10	17551
1-1/2"	.026/120	1/2"	3/8"	1/4"	10,000	10	17541
2"	.026/120	1/2"	3/8"	1/2"	10,000	10	17548
	.035/80						17555
2-1/2"	.026/120	5/8"	1/2"	11/16"	10,000	10	17556
	.035/80						17557
3"	.026/120	1/2"	1/2"	1"	10,000	10	17565
	.035/80						17567
	.043/120						17568

Other diameters and grit sizes available upon request.

### SMALL DIAMETER WHEELS - Metal Hub - Crimped Round Silicon Carbide Filament

Diameter	Filament Dia./Grit	Arbor Hole	Face Width	Trim Length	Max. RPM	Standard Pack	Item Number
1-1/8"	.022/120	1/4"	5/16"	1/4"	10,000	10	17532
1-1/4"	.022/120	1/4"	5/16"	5/16"	10,000	10	17535
1-3/8"	.018/500	1/4"	5/16"	3/8"	10,000	10	16316
1-1/2"	.022/120	1/2"	3/8"	1/4"	10,000	10	17628
	.035/180						29353
2"	.018/500	1/2"	3/8"	1/2"	10,000	10	17533
	.022/320						17543
	.040/120						17633
2"	.022/120	5/8"	7/16"	7/16"	10,000	10	17629
	.022/320						29356
2-1/2"	.022/120	5/8"	1/2"	11/16"	10,000	10	29123
	.035/180						29280
	.022/320						29088
3"	.035/180	1/2"	1/2"	1"	10,000	10	17563
	.022/320						16315
	.022/120						16315
	.040/120						16263

Other diameters and grit sizes available upon request.

### DRIVE ARBORS - For mounting small diameter wheels into a collet or chuck.

Arbor Diameter	Stem Diameter	Stem Length	Length of Shaft	For Brushes with Max. Dia. of	Overall Length	Max. RPM	Standard Pack	Item Number
<b>Unthreaded Shaft</b>								
1/4"	1/4"	1-1/8"	3/16"	2"	2-1/16"	20,000	5	07723
<b>Threaded Shaft</b>								
1/2"	1/4"	3/4"	3/4"	3"	1-3/4"	25,000	5	07724
5/8"	1/4"	3/4"	3/4"	3"	1-13/16"	25,000	5	07729
1/2"	1/4"	7/8"	3/4"	3"	1-11/16"	20,000	5	07721
1/4"	1/4"	1-1/16"	1-1/8"	2"	2-9/16"	20,000	5	07725

### PLASTIC ADAPTERS for mounting small diameter wheels onto various arbor sizes.

Fixed Arbor Hole Size	Adapted Arbor Hole Size	Standard Pack	Item Number
1/2"	1/4"	10	04400
1/2"	3/8"	10	04401
5/8"	1/2"	10	04402



Deburring the edges of a machined aluminum component.



17568



17533



07723



07724



07729



07721



07725



04401

04402

### NOTE

See adapters on pages 128-129

COATED ABRASIVES

NON-WOVEN ABRASIVES

POWER BRUSHES

NYLON BRUSHES

PACKAGED ITEMS

MAINTENANCE

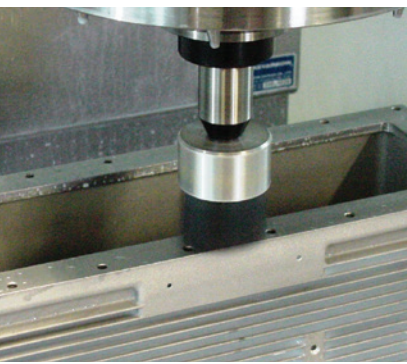

# END BRUSHES

Featuring an integral stem for convenient mounting into a tool holder or collet, Nylox® end brushes and miniature end brushes are suitable for addressing recesses and internal features, or delivering a targeted brushing action to a specific area on a part.

## APPLICATIONS

- Deburring small recessed areas and internal part features
- Finishing slots and recessed surfaces on machined parts

Deburring the machined face of an aluminum component.



86104

## BURR-RX® END BRUSHES - Banded - Crimped Round Black Ceramic Filament - Mounted on 1/4" Stems

Diameter	Filament Dia./Grit	Trim Length*	Recommended RPM	Overall Length	Max. RPM	Standard Pack	Item Number
3/8"	.026/120	1/4"	4,500 - 5,000	2-3/8"	10,000	10	86098
	.043/120						86099
1/2"	.026/120	1/4"	4,500 - 5,000	2-7/16"	10,000	10	86100
	.043/120						86101
3/4"	.026/120	1/4"	4,200 - 5,000	2-7/16"	10,000	10	86102
	.043/120						86103
1"	.026/120	1/4"	3,500 - 3,800	2-5/8"	10,000	10	86104
	.043/120						86105
	.055/80						86097

\* Trim length from bands



11166

## END BRUSHES - Banded - Crimped Round Silicon Carbide Filament - Mounted on 1/4" Stems

Diameter	Filament Dia./Grit	Trim Length*	Overall Length	Max. RPM	Standard Pack	Item Number
1/2"	.022/320	3/8"	2-9/16"	10,000	10	11160
	.035/180					11161
	.040/120					11162
3/4"	.035/180	3/8"	2-7/16"	10,000	10	11165
	.040/120					11166
1"	.035/180	3/8"	2-11/16"	10,000	10	11169
	.040/120					11170

\* Trim length from bands



10154

## END BRUSHES - Crimped Round Silicon Carbide Filament - Mounted on 1/4" Stems

Diameter	Filament Dia./Grit	Trim Length	Overall Length	Max. RPM	Standard Pack	Item Number
1/2"	.022/320	7/8"	2-9/16"	10,000	10	10172
	.035/180					10173
	.040/120					10174
3/4"	.022/320	7/8"	1-1/2"	10,000	10	10152
	.035/180					10153
	.040/120					10154
1"	.022/320	7/8"	2-3/4"	10,000	10	10155
	.035/180					10156
	.040/120					10157



26136

## MINIATURE END BRUSHES - Plastic Ferrule - Crimped Round Silicon Carbide Filament

Mounted on 1/8" stems

Diameter	Filament Dia./Grit	Trim Length	Overall Length	Max. RPM	Standard Pack	Item Number
3/16"	.018/500	1/4"	1-7/8"	37,000	144	26136
1/4"	.018/500	3/8"	2-1/8"	37,000	144	26138
5/16"	.018/500	9/16"	2-11/32"	25,000	144	26146

# MINI DISC BRUSHES

Featuring a precision machined aluminum cup, Weiler's mini-disc brushes are designed to be the most cost-effective media for applications requiring a smaller brushing tool.

## APPLICATIONS

- Deburring flat surfaces on machined components
- Improving texture characteristics on machined or ground surfaces
- Deburring face-milled castings or forgings
- Blending tool marks after machining or grinding

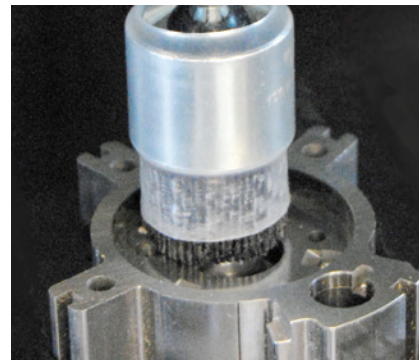

Deburring small features on a powdered metal part.

## BURR-RX® MINI DISC BRUSHES - Maximum Density - Crimped Black Ceramic Filament

Diameter	Filament Dia./Grit	Arbor Hole	Drive Arbor + Recommendation	Trim Length	Max. RPM	Standard Pack	Item Number
<b>Round Filament</b>							
2"	.026/120	3/8"	89029 or 89033	1-1/4"	4,500	2	86106
	.035/80					1	85738
	.043/120					2	86107
	.055/80					2	85733
3"	.026/120	3/8"	89029 or 89033	1-1/4"	4,500	1	86109
	.035/80						86013
	.043/120						86110
	.055/80						86111
<b>Rectangular Filament</b>							
2"	80	3/8"	89029 or 89033	1-1/4"	4,500	1	85736
3"	80	3/8"	89029 or 89033	1-1/4"	4,500	1	86014

+ See page 129 for drive arbor specifications.



85733

## MINI DISC BRUSHES - Silicon Carbide Filament

Diameter	Filament Dia./Grit	Arbor Hole	Drive Arbor + Recommendation	Trim Length	Max. RPM	Standard Pack	Item Number
<b>Round Filament</b>							
1-3/4"	.035/180	5/8"	89023 or 89024	1-1/4"	6,000	2	85753
	.022/120						85751
	.040/80						85750
<b>Rectangular Filament</b>							
1-3/4"	80	5/8"	89023 or 89024	1-1/4"	6,000	2	85752
2"	80	3/8"	89023 or 89024	1-1/4"	4,500	2	85773*
3"	80	3/8"	89023 or 89024	1-1/4"	4,500	1	85981*

+ See page 129 for drive arbor specifications. \* Maximum density

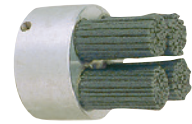

85752



85981

# CUP BRUSHES

Weiler also offers an assortment of Nylox® tools featuring traditional cup brush construction for deburring and finishing use in lighter duty applications. These brushing tools can be used on dedicated machines in automated processes or on low speed/high torque hand-held tools for manual applications.

## APPLICATIONS

- Deburring and finishing complex or contoured parts

## CUP BRUSHES - Crimped Round Silicon Carbide Filament



Diameter	Filament Dia./Grit	Arbor Hole	Trim Length	Max. RPM	Standard Pack	Item Number
2-3/4"	.022/320	1/4" Stem	1-1/4"	6,000	1	14401
	.035/180					14403
	.040/120					14404
3-1/2"	.035/180	5/8"-11	1-1/2"	12,000	1	14413
	.040/120					14414
5"	.040/120	5/8"-11	1-1/4"	8,000	1	14576
6"	.040/120	5/8"-11	1-1/4"	6,600	1	14516*
	.040/80					14506*

\* With internal nut



14413

**NOTE**  
See adapters  
on pages 128-129

COATED ABRASIVES

NON-WOVEN ABRASIVES

POWER BRUSHES

NYLOX BRUSHES

PACKAGED ITEMS

MAINTENANCE



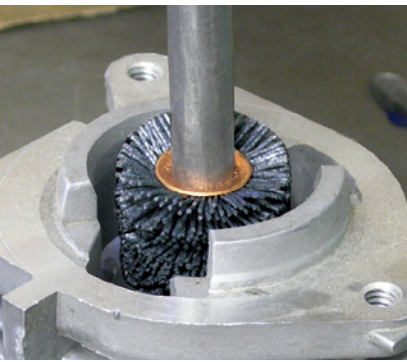

Deburring internal bores of a cylinder head.

## CUSTOMIZABLE CROSSHOLE DEBURRING SOLUTIONS

### Replacement Bore-Rx Brush Heads and Reusable Bore-Rx Arbors

In high production applications, reusable arbors reduce manufacturing costs by allowing the use of inexpensive brush head replacements. Brush heads are made-to-order in diameters ranging from 7/8" to 1-1/2" with face widths of 1/4" to 1". They are available on 3/16" and 1/4" pins. The pin diameter is based on the application and determines brush density. Contact Application Engineering at 888-299-APPS (2777) for more information.



Replacement Head



Reusable Arbor 03993



Reusable Extension 03991

# BORE-RX™ CROSSHOLE DEBURRING BRUSHES

These brushes are designed for automated applications in CNC machining centers and dedicated machines. They are ideal for removing burrs from internal edges and finishing bores. Since they eliminate off-hand deburring, they improve part-to-part consistency and reduce direct labor content. Bore-Rx brushes are available in sizes ranging from 7/8" to 4" and can be readily adapted into a machining center's tool changer using an end-mill holder or 3/8" collet.

### Operating Parameters For Bore-Rx Brushes

Brush Diameter	Recommended RPM	Recommended Feed Rate
5/8" - 7/8"	3000	20"/min
1" - 1-1/2"	3000	20"/min
2" - 2-1/2"	2000	20"/min
3" - 4"	1500	20"/min

### Tool Paths for Crosshole Deburring

An effective tool path for most crosshole deburring jobs is circular interpolation using the following guidelines to determine diameter of interpolation. The interpolation should be performed at a depth where the center of the brush face is at the center of the intersecting hole.

■ Diameter of Interpolation = Hole Dia. - 0.975 x Brush Dia.

### Tool Paths for Bore Finishing

Nylox® brushes can be used to improve the surface finish of bores. The best tool path normally involves helically interpolating the bore. The above recommendations for speed, feed and diameter of interpolation are also valid for bore finishing. The use of coolant is highly recommended in order to achieve maximum surface finish improvement.



86155



17208

### BORE-RX BRUSHES - 3/8" Stem - Crimped Round Black Ceramic Filament

Diameter	Filament Dia./Grit	Face Width	Trim Length	Overall Length	Max. RPM	Standard Pack	Item Number
7/8"	.026"/120	3/4"	.160"	4-3/4"	8,000	1	17206
1"	.026"/120	3/4"	.215"	4-3/4"	8,000	1	17208
1-1/4"	.026"/120	3/4"	.345"	4-3/4"	8,000	1	17210
1-1/2"	.026"/120	1"	.475"	5"	8,000	1	17212
2"	.026"/120	1"	.535"	3-1/4"	6,000	1	17215
2-1/2"	.055"/80	1"	.765"	3-1/4"	6,000	1	17217
3"	.026"/120	1"	.560"	3-1/4"	6,000	1	86150
	86151						
	86152						
4"	.026"/120	1"	1.040"	3-1/4"	6,000	1	86154
	.043"/120						86155
	.055"/80						86156

Note: All Bore-Rx brush stems have a 2" long flat for use in end mill holders. Alternatively, they can be mounted in 3/8" collets.

# TUBE BRUSHES

Nylox® power tube brushes are ideal for internal deburring and finishing applications in tubular component parts, drilled and tapered holes, and machined bores and passages. These brushes are suitable for use in drill presses and manual and CNC machine tools. See page 88 for operating guidelines.

### TUBE BRUSHES - Micro Abrasive - For ultra-fine deburring and finishing of small internal holes.



26904



26908



26915

Diameter	Length of Brush Part	Stem Diameter	For Hole Diameters		Overall Length	Standard Pack	Item Number
			Decimal	Fraction			
<b>2000 Grit Aluminum Oxide Filament</b>							
.030"	1/2"	.015	.031"	1/32"	4"	10	26900
.050"	1/2"	.022	.047"	3/64"	4"		26901
.075"	3/4"	.033	.063"	1/16"	4"		26902
.090"	3/4"	.041	.078"	5/64"	4"		26903
.105"	1"	.041	.094"	3/32"	4"		26904
.125"	1"	.064	.109"	7/64"	4"		26905
.135"	1"	.075	.125"	1/8"	4"		26906
<b>600 Grit Aluminum Oxide Filament</b>							
.165"	1"	.087	.156"	5/32"	5"	10	26907
.190"	1"	.087	.188"	3/16"	5"		26908
.260"	1"	.115	.250"	1/4"	5"		26909
.325"	1"	.115	.313"	5/16"	5"		26910
.385"	1"	.147	.375"	3/8"	5"		26911
.515"	1"	.194	.500"	1/2"	5"		26912
.640"	1"	.194	.625"	5/8"	5"		26913
.765"	1"	.212	.750"	3/4"	5"		26914
.890"	1"	.212	.875"	7/8"	5"		26915

**NEW! NOW OFFERING MORE SIZE OPTIONS**

**BURR-RX® TUBE BRUSHES** - Crimped Black Ceramic Filament - 1/4" Cadmium Plated Stems

Nominal Diameter	Traditional Diameter	Metric Diameter	Filament Dia./Grit	Length of Brush Part	Stem Diameter	Overall Length	Standard Pack	Item Number
6mm	0.236"	6.00 mm	.026/120	1"	1/4"	3-1/2"	10	22602
1/4"	0.250"	6.35 mm	.026/120	1"	1/4"	3-1/2"	10	21757
7mm	0.276"	7.00 mm	.026/120	1"	1/4"	3-1/2"	10	22603
8mm	0.315"	8.00 mm	.026/120	1"	1/4"	3-1/2"	10	22604
9mm	0.354"	9.00 mm	.026/120	1"	1/4"	3-1/2"	10	22605
3/8"	0.375"	9.53 mm	.026/120	1"	1/4"	3-1/2"	10	21758
10mm	0.394"	10.00 mm	.026/120	1"	1/4"	3-1/2"	10	22606
11mm	0.433"	11.00 mm	.026/120	1"	1/4"	3-1/2"	10	22607
12mm	0.472"	12.00 mm	.026/120	1"	1/4"	3-1/2"	10	22608
1/2"	0.500"	12.70 mm	.026/120	1"	1/4"	3-1/2"	10	21759
14mm	0.551"	14.00 mm	.026/120	1"	1/4"	3-1/2"	10	22610
9/16"	0.563"	14.29 mm	.026/120	1"	1/4"	3-1/2"	10	21760
5/8"	0.625"	15.88 mm	.026/120	1"	1/4"	3-1/2"	10	21761
18mm	0.709"	18.00 mm	.026/120	1"	1/4"	3-1/2"	10	22614
3/4"	0.750"	19.05 mm	.026/120	1"	1/4"	3-1/2"	10	21762
20mm	0.787"	20.00 mm	.026/120	1"	1/4"	3-1/2"	10	22616
7/8"	0.875"	22.23 mm	.026/120	1"	1/4"	3-1/2"	10	21763
1"	1.000"	25.40 mm	.026/120	1"	1/4"	3-1/2"	10	21764
1-1/4"	1.250"	31.75 mm	.026/120	1"	1/4"	3-1/2"	10	21765

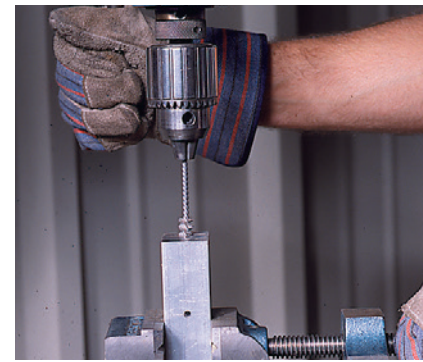

Crosshole deburring an aluminum manifold.



21759

**TUBE BRUSHES** - Crimped Round Silicon Carbide Filament - Double Stem, Single Spiral

Diameter	Filament Dia./Grit	Length of Brush Part	Stem Diameter	Overall Length	Standard Pack	Item Number
1/4"	.022/320	2"	5/32"	5"	10	21126
3/8"	.022/320	2"	5/32"	5"	10	21128
1/2"	.022/320 .040/80	2"	3/16"	5"	10	21130 21325
5/8"	.022/320 .040/80	2"	7/32"	5"	10	21132 21326
11/16"	.022/320	2"	7/32"	5"	10	21133
3/4"	.022/320 .040/80	2-1/2"	1/4"	5-1/2"	10	21134 21327
7/8"	.022/320 .040/80	2-1/2"	1/4"	5-1/2"	10	21136 21976
1"	.022/320 .040/80	2-1/2"	1/4"	5-1/2"	10	21138 21328
1-1/4"	.022/320 .022/120 .035/180 .040/80	2-1/2"	1/4"	5-1/2"	10	21306 21304 21305 21329
1-1/2"	.022/320 .035/180 .040/80	2-1/2"	1/4"	5-1/2"	10	21309 21308 21330
1-3/4"	.040/80 .035/180	2-1/2"	1/4"	5-1/2"	10	21311 21312
2"	.022/320 .040/80	2-1/2"	1/4"	5-1/2"	10	21473 21345



21128



21138



21473

COATED ABRASIVES

NON-WOVEN ABRASIVES

POWER BRUSHES

NYLON BRUSHES

PACKAGED ITEMS

MAINTENANCE

# FLAT SURFACE DEBURRING PRODUCTS

## DISC BRUSHES

Manufactured using a tufted filament configuration and longer trim length for increased aggression, greater conformability and longer product life in comparison to monofilament disc brushes, which feature a distribution of short individual bristles.

Burr-Rx® disc brushes feature Weiler's advanced black ceramic grain filament, which delivers up to a 400% greater edge cutting action in comparison to traditional silicon carbide and aluminum oxide filaments for the fastest, most aggressive deburring action for minimum cycle times and maximum life.

All Burr-Rx disc brushes are manufactured using a new process that results in a very consistent, flat brush face in comparison to traditional construction, which utilizes a molded backing. The high dimensional precision of these tools means that the brushes are suitable for the most critical applications and perform more consistently from first part to last. In addition, the machined polymer backings are designed to mount directly onto a standard shell mill holder for convenient use in CNC machining centers.

### APPLICATIONS

- Deburring flat surfaces on machined components
- Deburring face-milled castings or forgings
- Improving texture characteristics on machined or ground surfaces
- Blending tool marks after machining or grinding

### DISC BRUSHES

**0.075" - 0.100" DEPTH OF INTERFERENCE**

### OPERATING SPEEDS - DISC BRUSHES

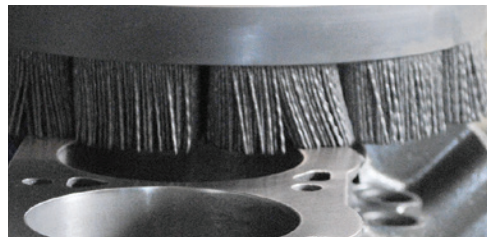

Diameter	RPM
1-3/4" & 2"	1,750 - 2,000
3"-4"	1,500 - 1,750
5" - 6"	1,250 - 1,500
8"	800 - 1,000
10"	700 - 800
12"	600 - 700
14"	500 - 600

### FEED RATE RECOMMENDATIONS

Feed rate is determined by the amount of deburring, edge radiusing or surface finishing required, and the type of material that is being processed. It is generally application specific. Slower feeds result in a more aggressive brushing action. Based on the brushing action desired for a specific application, the feed rate can be increased or decreased.

Material	SiC and AO Grain Feed Rate	Burr-Rx Grain Feed Rate
Non-Ferrous	50 in./min.	80 in./min.
Cast Iron	30 in./min.	60 in./min.
Mild Steel and Ductile Iron	25 in./min.	50 in./min.
Stainless and Alloy Steels	15 in./min.	30 in./min.
Titanium and High Nickel Alloys	10 in./min.	30 in./min.

### BURR-RX SHELL MILL HOLDER DISC BRUSHES - Crimped Black Ceramic Filament

Compatible with 3" shell mill holders.

Diameter	Filament Dia./Grit	Arbor Hole	Trim Length	Max. RPM	Standard Pack	Item Number
<b>Round Filament</b>						
4"	.026/120	1-1/4"	1-1/2"	2,500	1	86112
	.043/120					86113
	.043/120					86204*
	.055/80					86114*
6"	.026/120	1-1/4"	1-1/2"	2,500	1	86115
	.043/120					86116
	.055/80					86117*
8"	.026/120	1-1/4"	1-1/2"	2,000	1	86141
	.043/120					86142
	.055/80					86143*
10"	.026/120	1-1/4"	1-1/2"	2,000	1	86125
	.043/120					86121
	.055/80					86122*
<b>Rectangular Filament</b>						
4"	80	1-1/4"	1-1/2"	2,500	1	86167*
6"	80	1-1/4"	1-1/2"	2,500	1	86198*
8"	80	1-1/4"	1-1/2"	2,500	1	86199*

\* Maximum Density



Deburring a bearing cage in a CNC machining center.



Disc brush shown with shell mill holder



86112



86143



## COMPOSITE HUB DISC BRUSHES - Silicon Carbide Filament

Diameter	Filament Dia./Grit	Arbor Hole	Drive Arbor Recommendation	Trim Length	Max. RPM	Standard Pack	Item Number
<b>Crimped Round Filament</b>							
3"	.035/180 .040/120	7/8"	07700	1-1/2"	2,500	1	85776 85778
3-1/2"	.022/320 .035/180 .040/80	7/8"	07700	1-1/2"	2,500	1	85792 85794 85798
4"	.022/320 .035/180 .040/120 .040/80	7/8"	07700	1-1/2"	2,500	1	85812 85814 85816 85818
5"	.035/180 .040/80	7/8"	07700	1-1/2"	2,500	1	85832 85836
6"	.035/180 .040/120 .040/80	7/8"	07701	1-1/2"	2,000	1	85850 85852 85854
8"	.035/180 .040/120 .040/80	7/8"	07702	1-1/2"	2,000	1	85908 85912 85914
10"	.040/120 .040/80	7/8"	07703	1-1/2"	1,750	1	85930 85932
12"	.035/180 .040/120	7/8"	07703	1-1/2"	1,750	1	85946 85948
<b>Rectangular Filament</b>							
3"	120 80	7/8"	07700	1-1/2"	2,500	1	85786 85788
3-1/2"	320 80	7/8"	07700	1-1/2"	2,500	1	85800 85806
4"	180 120 80 80 80	7/8"	07700	1-1/2"	2,500	1	85822 85824 85826 85995 • 85900* •
5"	120 80 80	7/8"	07700	1-1/2"	2,500	1	85842 85844 85978 •
6"	120 80 80 80	7/8"	07701 07701 07715 07715	1-1/2"	2,000	1	85860 85862 85996 • 85901* •
8"	120 80	7/8"	07702	1-1/2"	2,000	1	85920 85922
9"	80	7/8"	07702	1-1/2"	1,750	1	85997 •
10"	120 80	7/8"	07703	1-1/2"	1,750	1	85938 85940

\* Banded for extra aggression

• Maximum density



Deburring the edges of an aluminum engine cover.



85852



85978

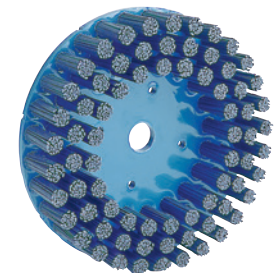

85920

COATED ABRASIVES

NON-WOVEN ABRASIVES

POWER BRUSHES

NYLON BRUSHES

PACKAGED ITEMS

MAINTENANCE

### Arbor & Drive Hole Specifications for Composite Hub Disc Brushes

Brush Diameter	Arbor Hole Diameter	Drive Holes
3"-5", 6" Max. Density	7/8"	(2) 1/4" dia. on a 1-1/4" dia. bolt circle
6"	7/8"	(3) 1/4" dia. on a 3" dia. bolt circle
8"	7/8"	(4) 1/4" dia. on a 3" dia. bolt circle
10"	7/8"	(4) 1/4" dia. on a 1.625" dia. bolt circle
12"	7/8"	(4) 1/4" dia. on a 1.625" dia. bolt circle

### NOTE

See adapters on pages 128-129



Removing burrs and breaking sharp edges on a transmission component.

# MINI DISC BRUSHES

Featuring a precision machined aluminum cup, Weiler's mini-disc brushes are designed to be the most cost-effective media for applications requiring a smaller brushing tool.

## APPLICATIONS

- Deburring flat surfaces on machined components
- Improving texture characteristics on machined or ground surfaces
- Deburring face-milled castings or forgings
- Blending tool marks after machining or grinding

## BURR-RX® MINI DISC BRUSHES - Maximum Density - Crimped Black Ceramic Filament



85733

Diameter	Filament Dia./Grit	Arbor Hole	Drive Arbor + Recommendation	Trim Length	Max. RPM	Standard Pack	Item Number
<b>Round Filament</b>							
2"	.026/120	3/8"	89029 or 89033	1-1/4"	4,500	2	86106
	.035/80					1	85738
	.043/120					2	86107
	.055/80					2	85733
3"	.026/120	3/8"	89029 or 89033	1-1/4"	4,500	1	86109
	.035/80						86013
	.043/120						86110
	.055/80						86111
<b>Rectangular Filament</b>							
2"	80	3/8"	89029 or 89033	1-1/4"	4,500	1	85736
3"	80	3/8"	89029 or 89033	1-1/4"	4,500	1	86014

+ See page 129 for drive arbor specifications.

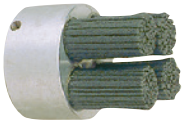

85752



85981

## MINI DISC BRUSHES - Silicon Carbide Filament

Diameter	Filament Dia./Grit	Arbor Hole	Drive Arbor + Recommendation	Trim Length	Max. RPM	Standard Pack	Item Number
<b>Round Filament</b>							
1-3/4"	.035/180	5/8"	89023 or 89024	1-1/4"	6,000	2	85753
	.022/120						85751
	.040/80						85750
<b>Rectangular Filament</b>							
1-3/4"	80	5/8"	89023 or 89024	1-1/4"	6,000	2	85752
2"	80	3/8"	89023 or 89024	1-1/4"	4,500	2	85773*
3"	80	3/8"	89023 or 89024	1-1/4"	4,500	1	85981*

+ See page 129 for drive arbor specifications. \* Maximum density



*"I have had no issues with any Weiler products. They are reliable. They make a good product. I don't think you could ask for anything else."*

- **Richard Carpenter**, Nuclear Industry Worker

# END BRUSHES

Featuring an integral stem for convenient mounting into a tool holder or collet, Nylox® end brushes and miniature end brushes are suitable for addressing recesses and internal features, or delivering a targeted brushing action to a specific area on a part.

## APPLICATIONS

- Deburring small recessed areas and internal part features
- Finishing slots and recessed surfaces on machined parts

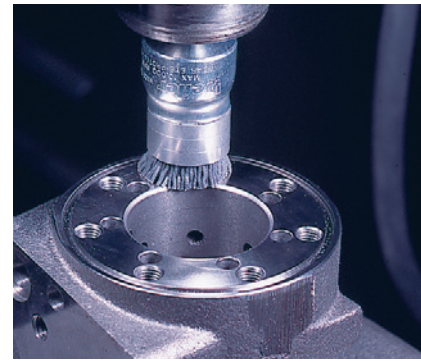

Blending tool marks on a hydraulic component.

## BURR-RX® END BRUSHES - Banded - Crimped Round Black Ceramic Filament - Mounted on 1/4" Stems

Diameter	Filament Dia./Grit	Trim Length*	Recommended RPM	Overall Length	Max. RPM	Standard Pack	Item Number
3/8"	.026/120	1/4"	4,500 - 5,000	2-3/8"	10,000	10	86098
	.043/120						86099
1/2"	.026/120	1/4"	4,500 - 5,000	2-7/16"	10,000	10	86100
	.043/120						86101
3/4"	.026/120	1/4"	4,200 - 4,500	2-7/16"	10,000	10	86102
	.043/120						86103
1"	.026/120	1/4"	3,500 - 3,800	2-5/8"	10,000	10	86104
	.043/120						86105
	.055/80						86097

\* Trim length from bands



86104

## END BRUSHES - Banded - Crimped Round Silicon Carbide Filament - Mounted on 1/4" Stems

Diameter	Filament Dia./Grit	Trim Length*	Overall Length	Max. RPM	Standard Pack	Item Number
1/2"	.022/320	3/8"	2-9/16"	10,000	10	11160
	.035/180					11161
	.040/120					11162
3/4"	.035/180	3/8"	2-7/16"	10,000	10	11165
	.040/120					11166
1"	.035/180	3/8"	2-11/16"	10,000	10	11169
	.040/120					11170

\* Trim length from bands



11166

## END BRUSHES - Crimped Round Silicon Carbide Filament - Mounted on 1/4" Stems

Diameter	Filament Dia./Grit	Trim Length	Overall Length	Max. RPM	Standard Pack	Item Number
1/2"	.022/320	7/8"	2-9/16"	10,000	10	10172
	.035/180					10173
	.040/120					10174
3/4"	.022/320	7/8"	1-1/2"	10,000	10	10152
	.035/180					10153
	.040/120					10154
1"	.022/320	7/8"	2-3/4"	10,000	10	10155
	.035/180					10156
	.040/120					10157



10154

## MINIATURE END BRUSHES - Plastic Ferrule - Crimped Round Silicon Carbide Filament

Mounted on 1/8" stems

Diameter	Filament Dia./Grit	Trim Length	Overall Length	Max. RPM	Standard Pack	Item Number
3/16"	.018/500	1/4"	1-7/8"	37,000	144	26136
1/4"	.018/500	3/8"	2-1/8"	37,000	144	26138
5/16"	.018/500	9/16"	2-11/32"	25,000	144	26146



26136

COATED ABRASIVES

NON-WOVEN ABRASIVES

POWER BRUSHES

NYLOX BRUSHES

PACKAGED ITEMS

MAINTENANCE



# TARGETED FEATURE DEBURRING PRODUCTS

## WHEEL BRUSHES

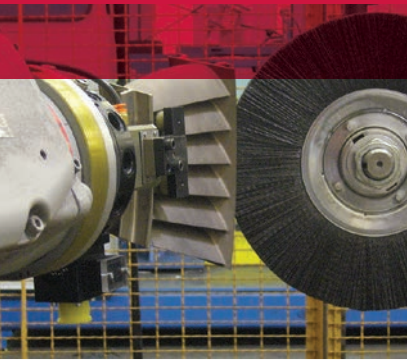

Deburring a vane section for a jet engine.

Weiler's Nylox® abrasive nylon wheel brushes featuring composite metal hub and composite hub construction are manufactured using a molded polymer material to retain the filaments. In comparison to traditional metal hub construction that folds the fill material around an internal retaining ring or wrap wire, these techniques result in a significant increase in fill density and elimination of filament breakage, offering the lowest cost-of-use and greatest consistency of performance in production applications.

Weiler's composite metal hub wheels marry the high density and superior filament retention of composite hub wheels with the dimensional stability and shock resistance of metal hub construction, and they feature 2" arbor holes, which allows for convenient mounting on many pieces of equipment.

Burr-Rx® wheels feature Weiler's advanced black ceramic grain filament, which delivers up to a 400% greater edge cutting action in comparison to traditional silicon carbide and aluminum oxide filaments for the fastest, most aggressive deburring action to minimize cycle times and maximize media life.

### APPLICATIONS

- Precision deburring of component parts after machining or grinding
- Improving texture characteristics on machined or ground surfaces
- Honing cutting tools and generating specific edge profiles and radii
- Light duty cleaning and finishing of metals; light sanding of woods and composites



86123



86131



86135

### BURR-RX CRIMPED FILAMENT WHEELS

Composite Metal Hub\* - Crimped Round Black Ceramic Filament

Diameter	Filament Dia./Grit	Arbor Hole	Face Width	Trim Length	Thickness At Face Plates	Max. RPM	Standard Pack	Item Number
6"	.026/120	2"	3/4"	1"	15/16"	4,000	1	86123
	.035/80							86181
	.043/120							86124
	.055/80							86120
8"	.026/120	2"	7/8"	2"	15/16"	4,000	1	86126
	.043/120							86127
	.055/80							86128
10"	.026/120	2"★	1-1/8"	2"	7/8"	1,800	2	86129
	.035/80							86182
	.043/120							86130
	.055/80							86131
12"	.026/120	2"★	1-1/4"	3"	7/8"	1,800	2	86132
	.043/120							86133
	.055/80							86134
	.026/120							86135
14"	.035/80	2"★	1"	1-3/4"	3/4"	1,800	2	86108
	.043/120							86136
	.055/80							86137
	.026/120							86138
14"	.043/120	2"★	1-1/4"	4"	7/8"	1,800	2	86139
	.055/80							86140
	.026/120							86138

\* Patent Pending

★ 1/2" x 1/4" Double Keyway



83394

### BURR-RX CRIMPED FILAMENT WHEELS

Composite Hub - Crimped Round Black Ceramic Filament

O.D. x I.D.	Filament Dia./Grit	Face Width	Trim Length	Thickness At Face Plates	Max. RPM	Standard Pack	Item Number
8" x 3-1/4"	.043/120	1"	1-5/16"	13/16"	1,800	2	83394
14" x 7-1/4"	.026/120	1"	2-3/4"	15/16"	1,800	2	84926
	.043/120						84941
	.035/80						84925
	.055/80						83405

## CRIMPED FILAMENT WHEELS - Composite Metal Hub\* - Crimped Round Silicon Carbide Filament

Diameter	Filament Dia./Grit	Arbor Hole	Face Width	Trim Length	Thickness Through Arbor	Max. RPM	Standard Pack	Item Number
6"	.018/500	2"	1"	1-1/4"	1-1/16"	4,000	1	83000
	.022/320							83010
	.022/120							83011
	.035/180							83030
	.040/120							83040
	.040/80							83050
	.060/46							83070
8"	.018/500	2"	1"	2-1/4"	3/4"	4,000	2	83100
	.022/320							83110
	.022/120							83111
	.035/180							83130
	.040/120							83140
	.040/80							83150
10"	.022/320	2"★	1-1/8"	2"	7/8"	1,800	2	83513
	.035/180							83514
	.040/120							83515
	.040/80							83516
12"	.022/320	2"★	1-1/4"	3"	7/8"	1,800	2	83715
	.035/180							83716
	.040/120							83717
	.040/80							83718

\*Patent Pending

★ 1/2" x 1/4" Double Keyway

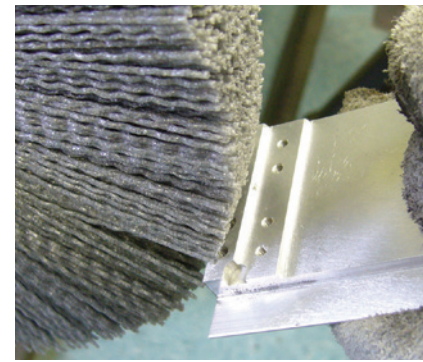

Removing burrs from an aluminum heat sink.



83000



83516



85014

## RECTANGULAR FILAMENT WHEEL - Composite Metal Hub\* - Straight Silicon Carbide Filament

Diameter	Grit Size	Arbor Hole	Face Width	Trim Length	Thickness Through Arbor	Max. RPM	Standard Pack	Item Number
12"	80	2"★	1-1/4"	3"	7/8"	1,800	2	85014

\*Patent Pending

★ 1/2" x 1/4" Double Keyway

## METAL HUB BASIC SECTIONS

### CRIMPED FILAMENT BASIC SECTIONS - Metal Hub - Crimped Round Silicon Carbide Filament

For light-duty deburring and finishing in applications such as low-volume manual deburring or general use in a tool room or shop.

O.D. x I.D.	Filament Dia./Grit	Face Width	Trim Length	Thickness Through Arbor	Max. RPM	Standard Pack	Item Number
6" x 2"	.022/320	5/8"	1-1/2"	9/16"	6,000	2	20600
	.035/180						20610
	.040/120						20620
8" x 2"	.022/320	5/8"	2-1/2"	9/16"	5,000	2	20630
	.040/120						20650
10" x 3-1/4"	.035/180	9/16"	2-7/8"	17/32"	4,500	2	20661
14" x 5-1/4"	.035/180	9/16"	3-7/8"	9/16"	3,000	2	20730

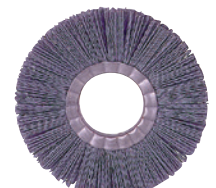

20620

**NOTE**  
See adapters  
on pages 128-129

COATED ABRASIVES

NON-WOVEN ABRASIVES

POWER BRUSHES

NYLON BRUSHES

PACKAGED ITEMS

MAINTENANCE



Deburring the tip of a turbine blade.

## NARROW FACE WHEELS

### BURR-RX® HEAVY-DUTY NARROW FACE WHEELS - Metal Hub - Crimped Round Black Ceramic Filament

Diameter	Filament Dia./Grit	Arbor Hole	Face Width	Trim Length	Thickness Through Arbor	Max. RPM	Standard Pack	Item Number
3"	.026/120	5/8"-1/2"	9/16"	1/2"	7/16"	6,000	2	31240
	.035/80							31241
4"	.026/120	5/8"-1/2"	5/8"	1"	7/16"	6,000	2	31110
	.035/80							31270
	.043/120							31280
	.055/80							31290



31110



86165

### BURR-RX NARROW FACE WHEELS - Metal Hub - Crimped Round Black Ceramic Filament

Diameter	Filament Dia./Grit	Arbor Hole	Face Width	Trim Length	Thickness Through Arbor	Max. RPM	Standard Pack	Item Number
3"	.035/80	1/2"-3/8"	3/8"	1/2"	7/16"	6,000	2	31102
	.043/120							31101
4"	.026/120	1/2"-3/8"	1/2"	7/8"	7/16"	6,000	2	86165
	.035/80							31103
	.043/120							31100
	.055/80							31105
6"	.026/120	5/8"-1/2"	5/8"	7/8"	11/16"	4,500	2	31134
	.043/120							31135
	.035/80							31136
	.055/80							31137

### HEAVY-DUTY NARROW FACE WHEELS - Metal Hub - Crimped Round Silicon Carbide Filament

Diameter	Filament Dia./Grit	Arbor Hole	Face Width	Trim Length	Thickness Through Arbor	Max. RPM	Standard Pack	Item Number
3"	.040/80	5/8"-1/2"	9/16"	1/2"	7/16"	6,000	2	31245
4"	.022/320	5/8"-1/2"	5/8"	1"	7/16"	6,000	2	31255
	.035/180							31265
	.040/120							31275
	.040/80							31285

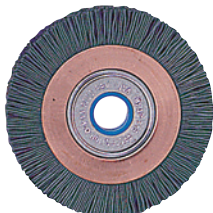

31255



31124

### NARROW FACE WHEELS - Metal Hub - Crimped Round Silicon Carbide Filament

Diameter	Filament Dia./Grit	Arbor Hole	Face Width	Trim Length	Thickness Through Arbor	Max. RPM	Standard Pack	Item Number
3"	.022/320	1/2"-3/8"	3/8"	1/2"	7/16"	6,000	2	31074
	.035/180							31084
	.040/120							31094
4"	.022/320	1/2"-3/8"	1/2"	7/8"	7/16"	6,000	2	31104
	.035/180							31114
	.040/120							31124
6"	.022/320	5/8"-1/2"	5/8"	7/8"	11/16"	4,500	1	31121
	.035/180							31122
	.040/120							31123



# APPLICATION ENGINEERED WHEELS

## CRIMPED FILAMENT WHEELS - Composite Hub - Crimped Round Silicon Carbide Filament

O.D. x I.D.	Filament Dia./Grit	Face Width	Trim Length	Thickness Through Arbor	Max. RPM	Standard Pack	Item Number
6" x 2"	.040/80	1/2"	1-1/4"	9/16"	3,600	1	83116
8" x 2"*	.040/120 .040/80	7/8"	2-1/8"	13/16"	3,600	2	83190 83180
8" x 3-1/4"	.040/80	1"	1-5/16"	13/16"	1,800	2	83393
10" x 2"	.018/500 .022/320 .035/180 .040/120 .040/80	1"	3"	1-1/16"	3,600	2	83300 83310 83330 83340 83350
10" x 3-1/4"	.035/180 .040/120 .040/80	1"	2-5/16"	13/16"	1,800	2	83430 83440 83450
10" x 5-1/4"	.040/80	1"	1-5/8"	15/16"	1,800	2	83550
12" x 3-1/4"	.035/180 .040/120	1-1/8"	3-5/16"	13/16"	1,800	2	83630 83640
12" x 4-1/4"	.022/320 .035/180 .040/120 .040/80	1"	3-1/8"	15/16"	1,800	2	84710 84730 84740 84750
12" x 5-1/4"	.040/120 .040/80	1-1/8"	2-3/4"	15/16"	1,800	2	83740 83750
12" x 5-1/4"-2"*	.022/320	1-1/8"	2-3/4"	1-1/16"	1,800	2	85156•
14" x 5-1/4"	.022/320 .035/180 .040/120 .040/80	1-1/8"	3-3/4"	15/16"	1,800	2	83910 83930 83940 83950
14" x 5-1/4"-2"*	.022/320 .040/80	1-1/8"	3-3/4"	1-1/16"	1,800	2	85150• 85153•
20" x 12"	.035/180	1-1/4"	3-1/4"	1-1/16"	1,000	1	85440

- Same density as our standard 5-1/4" I.D. brushes, but requires no adapters for mounting on a 2" diameter shaft.
- \* 1/2" x 1/4" Double Keyway

## RECTANGULAR FILAMENT WHEEL - Composite Hub - Straight Silicon Carbide Filament

O.D. x I.D.	Grit Size	Face Width	Trim Length	Thickness Through Arbor	Max. RPM	Standard Pack	Item Number
14" x 5-1/4"	120	1-1/8"	3-3/4"	1-1/16"	1,800	2	84640

Other diameters and grit sizes available upon request.

## DIAMOND FILAMENT WHEEL BRUSHES

Weiler's diamond filament wheels are ideal for producing edge radii on hard materials such as diamond, CBN, ceramic and glass. Our wheel brushes are made-to-order in a wide range of diameters and thicknesses. Additional configurations are available such as; tube brushes, composite hub disc brushes and end brushes. Other sizes and pricing are available on request. Please contact Customer Service at 800-835-9999.

### DIAMOND FILAMENT WHEELS - Composite Hub - Round Diamond Filament

O.D. x I.D.	Filament Dia./Grit	Face Width	Trim Length	Thickness Through Arbor	Max. RPM	Standard Pack	Item Number
6" x 2"	.024/200 .014/600 .012/1000	5/16"	1-1/4"	1/4"	3,600	1	83002 83003 83004
8" x 2"	.024/200 .014/600 .012/1000	5/16"	2-1/4"	1/4"	3,600	1	83005 83006 83007

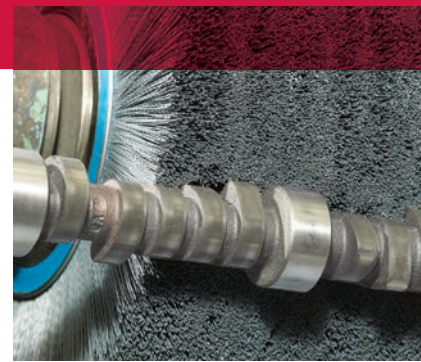

Deburring a camshaft with a Nylox wheel.



83190

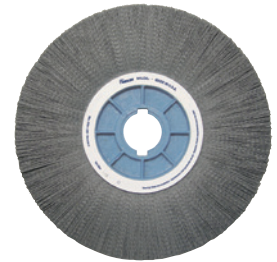

85150



84640



83005

**NOTE**  
See adapters  
on pages 128-129

COATED ABRASIVES

NON-WOVEN ABRASIVES

POWER BRUSHES

NYLOX BRUSHES

PACKAGED ITEMS

MAINTENANCE

# ADAPTERS AND DRIVE ARBORS



03809



03923



03944

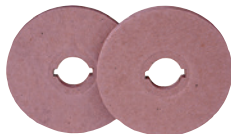

03403

## NOTE

The adapters and drive arbors listed on this page are for use with small diameter wheel brushes only; do not attempt to use them with cutting or grinding wheels, buffing wheels, or any type of abrasive wheel or disc.

## METAL ADAPTERS - Reusable - Used in pairs and priced per pair.

Diameter	Arbor Hole Size	Used With	Standard Pack	Item Number
2"	1/2"	All 2" I.D. Wheels	1	03809
	5/8"			03810
	3/4"			03811
	7/8"			03824
	1"			03812
	1-1/4"			03813
3-1/4"	1-1/2"	03814		
	3/4"	3-1/4" I.D. Wheels (When mounting only one wheel)	1	03910
	7/8"			03911
	1"			03912
	1-1/4"			03913
2"	03915			
5-1/4"	3/4"	5-1/4" I.D. Wheels (When mounting only one wheel)	1	03920
	7/8"			03921
	1"			03922
	1-1/4"			03923
	2"			03925

## STEEL FLANGES - Reusable - Used on the ends of a gang mount. Used in pairs and priced per pair. Must be used in conjunction with Pressboard Adapters in chart below.

Flange O.D.	Arbor Hole Size	Used With	Standard Pack	Item Number
5-5/8"	3/4"	3-1/4" & 4-1/4" I.D. Wheels	1	03931
	1"			03933
	1-1/4"			03934
	2"			03936
6-1/2"	1-1/4"	5-1/4" I.D. Wheels	1	03944
	1-1/2"			03945
	2"			03946
8-3/4"	1-1/4"	7-1/4" I.D. Wheels	1	03954
	1-1/2"			03955
	2"			03956

## PRESSBOARD ADAPTERS - Used for centering 10", 12" and 14" Nylox® Wheels when gang mounting. Must be used in conjunction with Steel Flanges in chart above.

Brush I.D.	Arbor Hole Size	Standard Pack	Item Number
3-1/4"	3/4"	1	03890
	1"		03892
	1-1/4"		03893
	2"		03895
	4-1/4"		1
1-1/4"	03963		
2"	03965		
5-1/4"	1-1/4"	1	03403
	1-1/2"		03404
	2"		03405
7-1/4"	1-1/4"	1	03973
	1-1/2"		03974
	2"		03975



83999

## Lubricut™ Lubricant

**Prevents Smearing.**  
**Improves the Finish.**  
**Lowers Costs.**



1. Turn off machine.



2. Slowly rotate wheel by hand.



3. While rotating, direct a light spray of Lubricut into the wheel face.

Use with Nylox® wheels operating above the recommended surface speed. Directing a light spray of Lubricut into the face of the wheel permits the wheel to be operated at higher surface speeds and up to twice the normal load without smearing - while improving the finish.

Description	Ounces	Standard Pack	Item Number
Lubricut Lubricant	8	1	83999

## PLASTIC ADAPTERS

Fixed Arbor Hole Size	Adapted Arbor Hole Size	Used With	Standard Pack	Item Number
1/2"	1/4"	Small Dia. Wheels	10	04400
1/2"	3/8"	Small Dia. Wheels	10	04401
5/8"	1/2"	Small Dia. Wheels	10	04402



## MINIATURE & BURR-RX® DISC BRUSH DRIVE ARBORS - Includes drive arbor, set screw and hex key.

For Brush Diameter	Stem Diameter	Stem Length	Max. RPM	Standard Pack	Item Number
1-3/4"	1/4"	1-3/4"	6,000	1	89023*
1-3/4"	3/8"	1-3/4"	6,000	1	89024*
2"-3"	1/2"	1-3/4"	6,000	1	89029*

\* For use with Burr-Rx Mini Disc brushes on page 117 & 122 only. Products supplied with set screw and wrench.



## MINIATURE & BURR-RX DISC BRUSH DRIVE ARBORS - Includes drive arbor, set screw and hex key. Recommended for operations in which brush rotation alternates between forward and reverse.

For Brush Diameter	Stem Diameter	Stem Length	Max. RPM	Standard Pack	Item Number
2"-3"	1/2"	1-3/4"	6,000	1	89033*

\* For use with Burr-Rx Mini Disc brushes on page 117 & 122 only. Products supplied with set screw and wrench.



## DISC BRUSH FLOW-THROUGH DRIVE ARBORS

Mounts Weiler disc brushes to any type of milling machine or CNC machine.

Fits	Arbor Hole	Drive Studs	Bolt Circle	Plate O.D.	Shaft Dia.	Stem Length	Std. Pack	Item Number
3", 4" and 5" Disc Brushes	7/8"	2	1-1/4"	2-7/8"	3/4"	2-3/4"	1	07700
6" Std. Tuft Disc Brushes NOT Max. Density	7/8"	3	3"	5-7/8"	3/4"	2-1/2"	1	07701
6" Max. Density Disc Brushes, also 5" Std. Tuft	7/8"	2	1-1/4"	4-7/8"	3/4"	2-1/2"	1	07715
8" and 9" Disc Brushes	7/8"	4	3"	7-7/8"	3/4"	2-1/2"	1	07702
10" and 12" Disc Brushes	7/8"	4	1-5/8"	9-7/8"	3/4"	2-1/2"	1	07703
Replacement kit includes: (1) 1/2"-13 locking flow-through bolt & (1) Belleville spring washer							1	07718



## NOTE

- Do not adapt a wheel brush for use on a shaft diameter less than that specified by ANSI B165.1 (see page 61) or exceed the maximum wheel diameter specified for a drive arbor.
- Never mount a drive arbor onto a tool that operates above the maximum RPM rating of either the arbor or the brush (whichever may be lower) and be sure that the stem of the arbor is properly secured in the collet or chuck before use.

WHY WEILER

BONDED ABRASIVES

COATED ABRASIVES

NON-WOVEN ABRASIVES

POWER BRUSHES

NYLON BRUSHES

PACKAGED ITEMS

MAINTENANCE



# FME AREA PRODUCT SOLUTIONS



Removing gasket material from a pipe flange.

In nuclear power plants, Foreign Material Exclusion (FME) programs may limit or even exclude the use of wire brushes in some areas during the performance of routine maintenance, repair or shut-down activities. Weiler has developed a FME-compliant tooling system to address the needs of plant operators and maintenance contractors working in these facilities as well as other industries where the potential introduction of broken wire filaments may be of concern. Weiler's FME Solutions program is a complete system consisting of non-wire brushing tools designed to perform a broad range of surface cleaning and preparation applications.

**BLACK NYLOX® CERAMIC BRUSHES** - The engineered ceramic grain in Weiler's Black Nylox filament is up to 400% more aggressive than the silicon carbide and aluminum oxide grain in other abrasive filaments, making it much more effective in surface cleaning applications. The efficient cutting action of the Black Nylox filament also generates less heat and makes it much more resistant to "smearing" than traditional nylon abrasive filaments.



31112

**NARROW FACE WHEELS** - Crimped Ceramic Filament  
Used on edge for weld prep and cold weld cleaning.

Diameter	Filament Dia./Grit	Face Width	Arbor Hole	Max. RPM	Standard Pack	Item Number
4"	.055/80	1/2"	5/8"-11 Nut	4,800	5	31112
4"	.043/120	1/2"	5/8"-11 Nut	4,800	5	31111



86160

**CUP BRUSH** - Rectangular Ceramic Filament  
Used on its face for heavy-duty cleaning of broad surfaces.

Diameter	Filament Dia./Grit	Arbor Hole	Max. RPM	Standard Pack	Item Number
4"	.049 x .098 - 80 Grit	5/8"-11 Nut	4,800	1	86160



86148

**END BRUSH** - Crimped Ceramic Filament - 1/4" Stem  
For spot-facing or cleaning in tight areas.

Diameter	Filament Dia./Grit	Trim Length	Overall Length	Max. RPM	Standard Pack	Item Number
1"	.055/80	1/4"	3-3/32"	4,800	10	86148



86159

**CONTROLLED FLARE END BRUSH** - Crimped Ceramic Filament - 1/4" Stem  
For cleaning corners and tight areas.

Diameter	Filament Dia./Grit	Trim Length	Overall Length	Max. RPM	Standard Pack	Item Number
1"	.035/80	1-1/8"	2-1/2"	4,800	10	86159



86171

**CONFLEX BRUSHES** - Crimped Ceramic Filament - 1/4" Stem  
For O.D. and I.D. cleaning in confined areas.

Diameter	Filament Dia./Grit	Face Width	Trim Length	Max. RPM	Standard Pack	Item Number
3"	.043/120	1"	15/16"	4,800	10	86171
3"	.055/80	1"	15/16"	4,800	10	86172



44144



95016

**HAND SCRATCH BRUSHES** - Crimped Ceramic Filament - For general purpose, light-duty cleaning.

Overall Length	Block Type	Brush Part	Grit Size	Trim Length	Standard Pack	Item Number
10"	Wood	5"	80	3/4"	12	44144
8-3/4"	Wood	2 x 9 Rows	120	5/8"	36	95016

## NOTE

Nylon abrasive filament brushes require a lower operating RPM than most other power tool accessories and they cannot be used effectively on standard grinders.

# VENDING READY

## WHAT YOU NEED. WHEN YOU NEED IT.

We understand that a successful vending program requires products that fit into a machine without hassle and dispense properly, every time. Weiler now offers single pack quantities of vending-ready products. Our packaging eliminates the need to re-pack products, which can be both expensive and time consuming.

In addition to single packs, Weiler's products are also available in small intermediate pack quantities for easy refill. This minimizes the handling from your storage location all the way to the end-user. Our products come the way you need them, ready to load into vending machines.

### QUALITY:

The same high performance Weiler products you know and trust now available for vending.

### PROVEN:

Our Weiler vending products are guaranteed to work within all Helix-coil vending machines.

### CONVENIENT:

We package and ship in easily refillable quantities, reducing your costs.

### RELIABLE:

All vending products guaranteed in-stock for quick, reliable shipping anywhere at any time.



Our vending program drives cost out of the supply chain for our business partners by simplifying the vending process.





13106V

**P** **STANDARD TWIST WHEELS** Provide heavy-duty brushing action on somewhat irregular surfaces.



Dia.	Wire Size	Arbor Hole	No. of Knots	Face Width	Trim Length	Max. RPM	Intermediate Pack	Item Number	
								Steel	Stainless
3"	.014	1/2"-3/8"	20	3/8"	5/8"	25,000	5	08014V	08264V
4"	.014	5/8"-11 UNC	24	1/2"	7/8"	20,000	5	13106V	13113V
	.020							13120V	-



13266V

**P** **CABLE TWIST WHEELS** Provide heavy-duty brushing action on relatively smooth surfaces.



Dia.	Wire Size	Arbor Hole	No. of Knots	Face Width	Trim Length	Max. RPM	Intermediate Pack	Item Number	
								Steel	Stainless
4"	.020	5/8"-11 UNC	24	1/4"	7/8"	20,000	5	13266V	-
		1/2"-3/8"						08534V	-
6"	.023	5/8"-1/2"	24	3/8"	1-3/8"	9,000	5	08565V	-



13131V

**P** **ROUGHNECK® STRINGER BEAD WHEELS** - The go to for high-performance weld cleaning.



Dia.	Wire Size	Arbor Hole	No. of Knots	Face Width	Trim Length	Max. RPM	Intermediate Pack	Item Number	
								Steel	Stainless
<b>Root Pass Brushes</b>									
4"	.020	5/8"-11 UNC	32	3/16"	7/8"	20,000	5	13131V	13138V
4-1/2"	.020	5/8"-11 UNC	38	3/16"	13/16"	12,500	5	13232V	-
5"	.020	5/8"-11 UNC	38	3/16"	7/8"	12,500	5	08756V	08806V
6"	.020	5/8"-11 UNC	48	3/16"	1-1/8"	12,500	1	08766V	-
6"	.020	5/8"-11 UNC	56	3/16"	1-1/8"	9,000	1	09400V	-
7"	.020	5/8"-11 UNC	56	3/16"	1-1/8"	9,000	1	09000V	-
<b>Filler Pass Brushes</b>									
6"	.023	5/8"-11 UNC	24	1/2"	1-3/8"	12,500	1	08776V	-



08776V



17687V

**P** **STEM MOUNTED KNOT WHEELS** - 1/4" stem - Ideal for somewhat irregular surfaces.



Dia.	Wire Size	No. of Knots	Face Width	Trim Length	Max. RPM	Intermediate Pack	Item Number	
							Steel	Stainless
3-1/4"	.014	20	3/8"	5/8"	25,000	1	17681V	-
4"	.014	24	1/2"	7/8"	20,000	5	17687V	-



17616V

**P** **CONFLEX BRUSHES** - Copper center wheels mounted onto a 1/4" stem provide very flexible brushing.



Dia.	Wire Size	Face Width	Trim Length	Max. RPM	Intermediate Pack	Item Number		
						Steel	Stainless	Brass
2"	.0118	3/8"	1/2"	20,000	1	17610V	17611V	-
3"	.008	1/2"	1"	20,000	1	17615V	-	-
	.0118					17616V	-	17641V
	.014					-	17618V	-

Key:  
**P** Performance line  
 Industrial Grade



**P** **KNOT WIRE CUP BRUSHES** Provide heavy-duty brushing action on relatively flat surfaces.



Diameter	Wire Size	Arbor Hole	Trim Length	Max. RPM	Intermediate Pack	Item Number	
						Steel	Stainless
2-3/4"	.014	5/8"-11 UNC	1"	14,000	1	13025	—
	.020					13286	13258
3-1/2"	.023	5/8"-11 UNC	7/8"	13,000	1	13156	13163
4"	.023	5/8"-11 UNC	1-1/4"	10,200	1	12316	—
5"	.023	5/8"-11 UNC	1-3/8"	9,000	1	12276	—
6"	.014	5/8"-11 UNC	1-3/8"	6,600	1	12356	—
	.023					12376	—



13156  
12376

**P** **CRIMPED CUP BRUSHES** Provide consistent performance on light-duty cleaning applications.



Diameter	Wire Size	Arbor Hole	Trim Length	Max. RPM	Intermediate Pack	Item Number
						Steel
3"	.014	5/8"-11 UNC	1"	14,000	1	13245
3-1/2"	.014	5/8"-11 UNC	7/8"	12,000	1	13181
4"	.014	5/8"-11 UNC	1-3/8"	10,200	1	14026
5"	.014	5/8"-11 UNC	1-1/4"	9,000	1	14206
6"	.014	5/8"-11 UNC	1-1/4"	6,600	1	14066



13245

**P** **UTILITY CRIMPED WIRE CUP BRUSHES** - Small diameter cup brushes for use on air tools.



Diameter	Wire Size	Trim Length	Overall Length	Max. RPM	Intermediate Pack	Item Number
						Steel
1-3/4"	.0118	3/4"	2-5/16"	13,000	1	14301V
2-3/4"	.0118	7/8"	2-1/2"	6,000	1	14302



14301V

**P** **CIRCULAR FLARED END BRUSH** - Suited for broad and slightly contoured surfaces.



Diameter	Wire Size	Max. RPM	Intermediate Pack	Item Number
				Steel
3"	.008	16,000	1	10041V



10041V

**P** **KNOT WIRE END BRUSHES** Provide heavy-duty brushing action in recessed areas.



Diameter	Wire Size	Trim Length	Overall Length	Max. RPM	Intermediate Pack	Item Number	
						Steel	Stainless
3/4"	.020	7/8"	2-5/8"	22,000	3	10026V	—
	.014					—	10029V
1-1/8"	.014	7/8"	2-5/8"	22,000	3	10027V	10031V
	.020					10028V	—
	.006					1-1/8"	2-9/16"



10026V

**P** **CRIMPED WIRE END BRUSHES** - Solid end construction for cleaning hard-to-reach areas.



Diameter	Wire Size	Trim Length	Overall Length	Max. RPM	Intermediate Pack	Item Number	
						Steel	Stainless
1/2"	.006	7/8"	2-9/16"	25,000	3	10001V	10013V
3/4"	.006	7/8"		22,000	3	10005V	10017V
	.020					10008V	—
1"	.006	1"	2-13/16"	22,000	3	10009V	10021V
	.0104		2-5/8"			10010V	10022V
	.020		1-1/8"			2-15/16"	10012V



10009V



21077V



21110V

**P** **ROUND TUBE BRUSHES** - Crimped wire fill provides flexible brushing action.



Diameter	Wire Size	Brush Part	Stem Diameter	Overall Length	Intermediate Pack	Item Number	
						Steel	Stainless
1/4"	.004	1"	1/8"	3-1/2"	3	-	21081V
3/8"	.004	1"	1/8"	3-1/2"	3	21073V	-
1/2"	.005	1"	3/16"	3-1/2"	3	21074V	-
5/8"	.005	1"	3/16"	3-1/2"	3	21075V	-
7/8"	.006	1"	7/32"	3-1/2"	3	21077V	-
1"	.008	1"	1/4"	3-1/2"	3	21078V	-
<b>Double Stem, Double Spiral</b>							
1/2"	.006	2"	5/32"	5"	6	21107V	-
5/8"	.005	2"	7/32"	5"	6	21108V	-
3/4"	.006	2-1/2"	1/4"	5-1/2"	6	21110V	-
1"	.006	2-1/2"	1/4"	5-1/2"	6	21114V	-



44080V

**P** **INTERNAL TUBE FITTING BRUSHES** - Wire Fill - For internal cleaning and deburring of copper tube fittings.

Tube Diameter	Actual Diameter	Brush Length	Overall Length	Handle Length	Intermediate Pack	Item Number
3/8"	1/2"	1"	6-1/2"	3-1/4"	6	44080V



44089V

**P** **ACID BRUSHES** - Horsehair - Tin ferrule (unit packs of 4)

Width	Trim Length	Overall Length	Intermediate Pack	Item Number
5/16"	3/4"	5-3/4"	6	44088V
3/8"	3/4"	5-3/4"	6	44089V
1/2"	3/4"	5-3/4"	6	44090V



44063

**P** **SCRATCH BRUSHES** - Ideal for cleaning and prepping surfaces.

Block Size	Brush Length	No. of Rows	Trim Length	Overall Length	Intermediate Pack	Item Number
14" x 7/8"	5-1/2"	3 x 19	1-3/16"	14"	1	44053 44054
10" x 1-1/8"	5"	4 x 16	1-3/16"	10"	1	44063 44064



44167V



44189V



44637V

**P** **SMALL SCRATCH BRUSHES** - Ideal for cleaning and prepping surfaces. (unit packs of 3)

Block Size	Block	No. of Rows	Wire Size	Trim Length	Overall Length	Intermediate Pack	Item Number
<b>Stainless Steel Wire</b>							
7-1/2" x 1/2"	Plastic	3 x 7	.006	1/2"	7-1/2"	5	44075V 44167V
<b>Straight Brass Wire</b>							
7-1/2" x 1/2"	Wood	3 x 7	.006	1/2"	7-1/2"	5	44189V
<b>Straight Black Nylon</b>							
7-1/2" x 1/2"	Wood	3 x 7	.012	1/2"	7-1/2"	5	44637V

**WHAT YOU NEED.  
WHEN YOU NEED IT.**



Key:

**P** Performance line  
Industrial Grade

**V** Value line  
Professional Grade

**V****WOLVERINE™ MOUNTED FLAP WHEELS** - 1/4" Stem – Provide fast action at a value price.

Diameter	Width	Grit Size	Max. RPM	Intermediate Pack	Item Number
1"	1"	60	30,000	3	30720V
		80			30721V
2"	1"	60	25,000	1	30723V
		80			30724V
3"	1"	60	23,000	1	30726V
		80			30727V

**30726V****P****TRIMMABLE TIGER® FLAP DISC** - (Type 29) – Trimmable backing for extended disc life.

Diameter	Arbor Hole	Grit Size	Max. RPM	Intermediate Pack	Item Number
4-1/2"	5/8"-11 Nut	40	13,000	5	50006V
		60			50007V

**50007V****P****TIGER PAW™ FLAP DISC** - (Type 29) – 100% Zirconia Alumina grain for performance & long life.

Diameter	Arbor Hole	Grit Size	Max. RPM	Intermediate Pack	Item Number
4-1/2"	7/8"	40	13,000	5	51119V
		60			51120V
4-1/2"	5/8"-11 Nut	40	13,000	5	51124V
		60			51125V

**51120V****P****TIGER FLAP DISC** - (Type 29) - Maximum aggression & long life.

Diameter	Arbor Hole	Grit Size	Max. RPM	Intermediate Pack	Item Number
<b>Zirconia Alumina Grain, Aluminum Backing</b>					
4-1/2"	7/8"	40	13,000	5	50513V
		60			50514V
4-1/2"	5/8"-11 Nut	40	13,000	5	50518V
		60			50519V
<b>Zirconia Alumina Grain, Phenolic Backing</b>					
4-1/2"	7/8"	40	13,000	5	51201V
		60			51202V
4-1/2"	5/8"-11 Nut	40	13,000	5	51205V
		60			51206V

**50513V****51201V****P****BIG CAT® FLAP DISC** - High Density (Type 27) – Increased conformability and maximum life.

Diameter	Arbor Hole	Grit Size	Max. RPM	Intermediate Pack	Item Number
<b>Zirconia Alumina Grain, Phenolic Backing</b>					
4-1/2"	7/8"	40	12,000	5	50803V
		60			50804V
4-1/2"	5/8"-11 Nut	40	12,000	5	50808V
		60			50809V

**50804V****P****SABER TOOTH™ FLAP DISC** - (Type 29) – Cool, fast cutting.

Diameter	Arbor Hole	Grit Size	Max. RPM	Intermediate Pack	Item Number
<b>Ceramic Alumina Grain, Phenolic Backing</b>					
4-1/2"	5/8"-11 Nut	40	13,000	5	50105V
		60			50106V

**50105V**

WHY WEILER

BONDED ABRASIVES

COATED ABRASIVES

NON-WOVEN ABRASIVES

POWER BRUSHES

NYLON BRUSHES

PACKAGED ITEMS

MAINTENANCE



# DISPLAY READY

Weiler industrial grade items are available in highly visible packaging, ready to hang on a display. Customers can see products and compare specifications, enabling them to easily pick the right product for the job. Package labeling includes important technical information and UPC bar codes. A multi-lingual safety slip is included with all products, providing comprehensive information on the safe use of the product.

**FOR IN-STORE DISPLAY SOLUTIONS**  
contact your Weiler District Sales Manager.





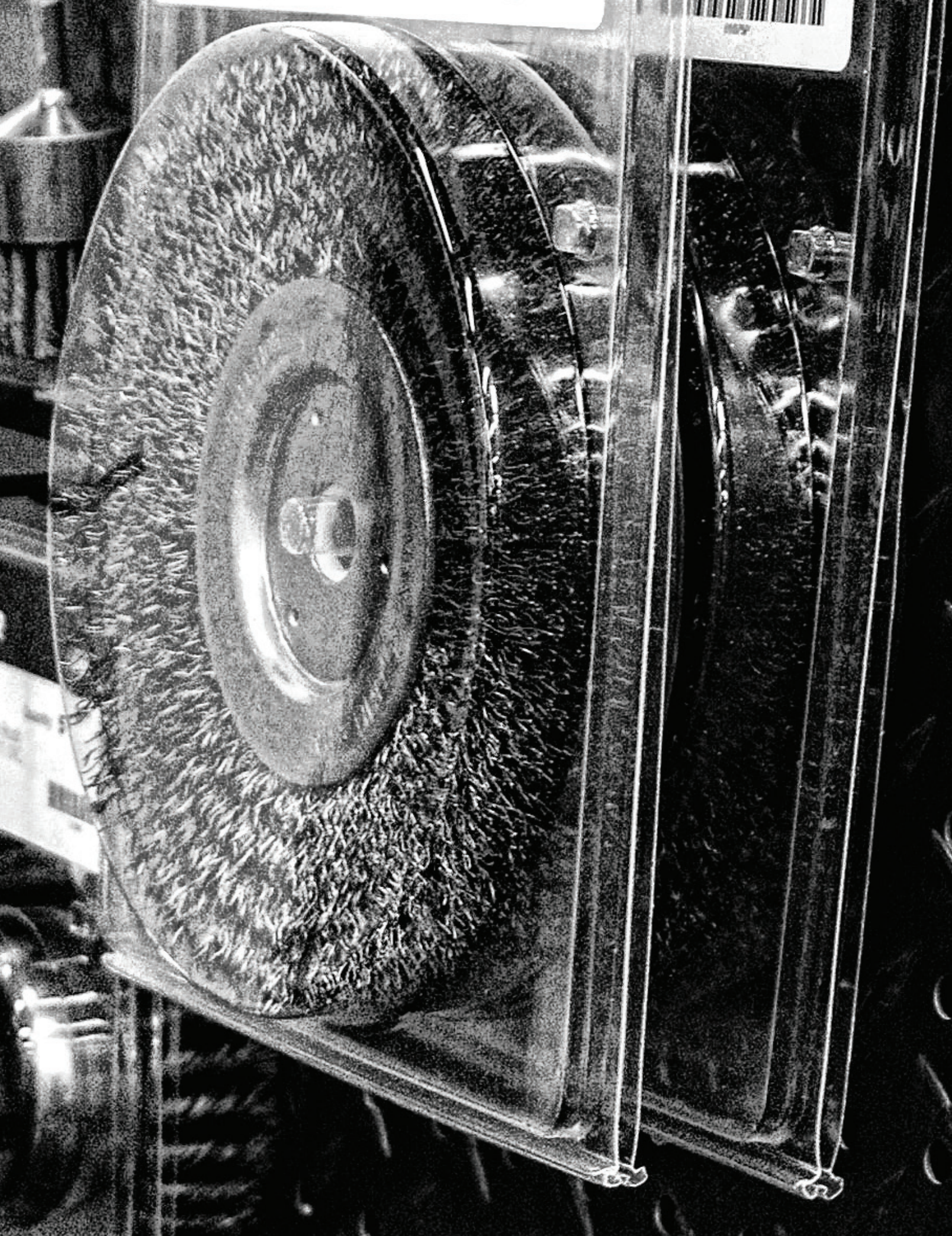





13106P

**P STANDARD TWIST WHEELS** provide heavy-duty brushing action with some flexibility; ideal for demanding cleaning applications on somewhat irregular surfaces.



Dia.	Wire Size	Arbor Hole	No. of Knots	Face Width	Trim Length	Max. AH Avail.	Thickness at Face Plates	Max. RPM	Std. Pack	Item Number	
										Steel	Stainless
3"	.014	1/2"-3/8"	20	3/8"	5/8"	1/2"	7/16"	25,000	1	08014P	—
4"	.014	1/2"-3/8"	24	1/2"	7/8"	1/2"	7/16"	20,000	1	08044P	—
4"	.014	5/8"-11	24	1/2"	7/8"	—	7/16"	20,000	1	13106P	13113P
6"	.014	5/8"-1/2"	24	1/2"	1-3/8"	1-1/4"	9/16"	9,000	1	08085P	—



13266P

**P CABLE TWIST WHEEL** provides maximum brushing action with minimal flexibility; ideal for demanding cleaning and surface preparation applications on smooth surfaces.



Dia.	Wire Size	Arbor Hole	No. of Knots	Face Width	Trim Length	Max. AH Avail.	Thickness at Face Plates	Max. RPM	Std. Pack	Item No.
										Steel
4"	.020	5/8"-11 UNC	24	1/4"	7/8"	1/2"	7/16"	20,000	1	13266P



13131P

**P ROUGHNECK® STRINGER BEAD WHEELS** - Maximum impact action for fast removal of slag, spatter, oxidation as well as other surface prep and cleaning applications.



Diameter	Wire Size	Arbor Hole	No. of Knots	Face Width	Trim Length	Thickness at Face Plates	Max. RPM	Standard Pack	Item Number	
									Steel	Stainless
4"	.020	M10 x 1.25	32	3/16"	7/8"	7/16"	20,000	1	13125P	—
		5/8"-11 UNC							13131P	13138P
6"	.020	5/8"-11 UNC	56	3/16"	1-1/8"	7/16"	12,500	1	09400P	—
	.023	5/8"-11 UNC	24	1/2"	1-3/8"	9/16"	—	—	08776P	—
7"	.020	5/8"-11 UNC	56	3/16"	1-1/8"	7/16"	9,000	1	09000P	—



01075P

**P CRIMPED WIRE WHEELS** provide a flexible brushing action and consistent performance for demanding light-duty cleaning and deburring applications.



Dia.	Wire Size	Arbor Hole	Face Width	Trim Length	Max. AH Avail.	Thickness at Face Plates	Max. RPM	Std. Pack	Item Number
									Steel
6"	.014	5/8"-1/2"	3/4"	1-7/16"	1-1/4"	7/16"	6,000	1	01075P
			5/8"	1-1/16"	—	1/2"			02325P
			7/8"	1-1/8"	—	7/8"			06645P
7"	.014	5/8"-1/2"	3/4"	1-9/16"	—	1/2"	6,000	1	02335P
8"	.014	5/8"	3/4"	2-1/16"	1-1/4"	1/2"	6,000	1	01175P



**P** **CONFLEX BRUSHES** - Small diameter copper center wheels permanently mounted onto a 1/4" stem to provide a very flexible brushing action.



Diameter	Wire Size	Face Width	Trim Length	Max. RPM	Standard Pack	Item Number
						Steel
3"	.008	1/2"	1"	20,000	1	17615P
	.014					17617P



17617P

**P** **KNOT WIRE CUP BRUSHES - Single Row** - Provide heavy-duty brushing action with some flexibility; ideal for demanding cleaning applications on relatively flat surfaces.



Diameter	Wire Size	Arbor Hole	Trim Length	Max. RPM	Standard Pack	Item Number
						Steel
2-3/4"	.014	5/8"-11 UNC	1"	14,000	1	13025P
2-3/4"	.020	M10 x 1.25	1"	14,000	1	13281P
		5/8"-11 UNC				13286P
3-1/2"	.023	5/8"-11 UNC	7/8"	13,000	1	13156P
4"	.023	5/8"-11 UNC	1-1/4"	10,200	1	12316P
5"	.023	5/8"-11 UNC	1-3/8"	7,000	1	12276P*
6"	.023	5/8"-11 UNC	1-3/8"	6,600	1	12376P



12316P

\* With internal nut

**P** **CRIMPED WIRE CUP BRUSHES** provide very flexible brushing action and the most consistent performance for demanding light-duty cleaning applications; feature a threaded nut for use on angle grinders.



Diameter	Wire Size	Arbor Hole	Trim Length	Max. RPM	Standard Pack	Item Number
						Steel
3"	.014	M10 x 1.25	1"	14,000	1	13240P
		5/8"-11 UNC				13245P
4"	.020	5/8"-11 UNC	1-3/8"	9,000	1	14036P
6"	.020	5/8"-11 UNC	1-1/4"	6,600	1	14076P*



13245P

\* With internal nut

**P** **THREADED ADAPTERS** - For mounting brushes with a 5/8"-11 UNC nut to other threaded spindles.

Fixed Thread Size	Adapted Thread Size	Standard Pack	Item Number
5/8" - 11 UNC	M10 x 1.25	1	07771P
5/8" - 11 UNC	M10 x 1.50	1	07772P



07771P

Key:

**P** Performance line  
Industrial Grade

**V** Value line  
Professional Grade



10028P

**P** **KNOT WIRE END BRUSHES** - Feature a hollow end and heavy-duty brushing action with some flexibility; ideal for more demanding cleaning applications in recessed areas.



Diameter	Wire Size	Trim Length	Overall Length	Max. RPM	Standard Pack	Item Number
						Steel
3/4"	.014	1-1/8"	2-5/8"	22,000	1	10025P
	.020					10026P
1-1/8"	.014	7/8"	2-5/8"	22,000	1	10027P
	.020					10028P



10012P

**P** **CRIMPED WIRE END BRUSH** - Feature a solid end construction and very flexible brushing action ideal for more demanding light-duty cleaning applications in corners and hard-to-reach areas.



Diameter	Wire Size	Trim Length	Overall Length	Max. RPM	Standard Pack	Item Number
						Steel
1"	.020	1-1/8"	2-5/8"	20,000	1	10012P

Key:

**P** Performance line  
Industrial Grade

**V** Value line  
Professional Grade

P

**MINI-GRINDER KIT** - For use on small right angle grinders. All products have a 5/8"-11 Arbor Hole



Kit Contains	Item Number
4-1/2" Abrasive Flap Disc (Zirconium Grain, 60 Grit); Item #50519: For grinding and finishing in one step.	13001
2-3/4" Knot Wire Cup Brush (.020 Steel Wire); Item #13286: For cleaning large surface areas.	
4" Stringer Bead Knot Wire Wheel (.020 Steel Wire); Item #13131 For weld cleaning, deburring and surface preparation.	



13001

P

**AIR TOOL/DRILL ACCESSORY KIT** -All products have a 1/4" Stem and are ideal for general purpose cleaning and deburring in recessed or confined areas.



Kit Contains	Item Number
3" Crimped Wire Wheel (.0118 Steel Wire); Item #17616	13002
1-3/4" Crimped Wire Cup Brush (.0118 Steel Wire); Item #14301	
3/4" Crimped Wire End Brush (.020 Steel Wire); Item #10008	
3" Abrasive Flap Wheel (Aluminum Oxide Grain, 80 Grit); Item #52028	



13002

P

**STAINLESS STEEL SCRATCH BRUSH COUNTERTOP DISPLAY**

Ideal for removing rust, scale and paint from metal surfaces.

Display Contains	Item Number
(36) Stainless Steel Small Hand Scratch Brushes, 7-1/2" x 1/2" Block Wood Handle; Item #44167	61012



61012

WHY WEILER BONDED ABRASIVES

COATED ABRASIVES

NON-WOVEN ABRASIVES

POWER BRUSHES

NYLOX BRUSHES

PACKAGED ITEMS

MAINTENANCE







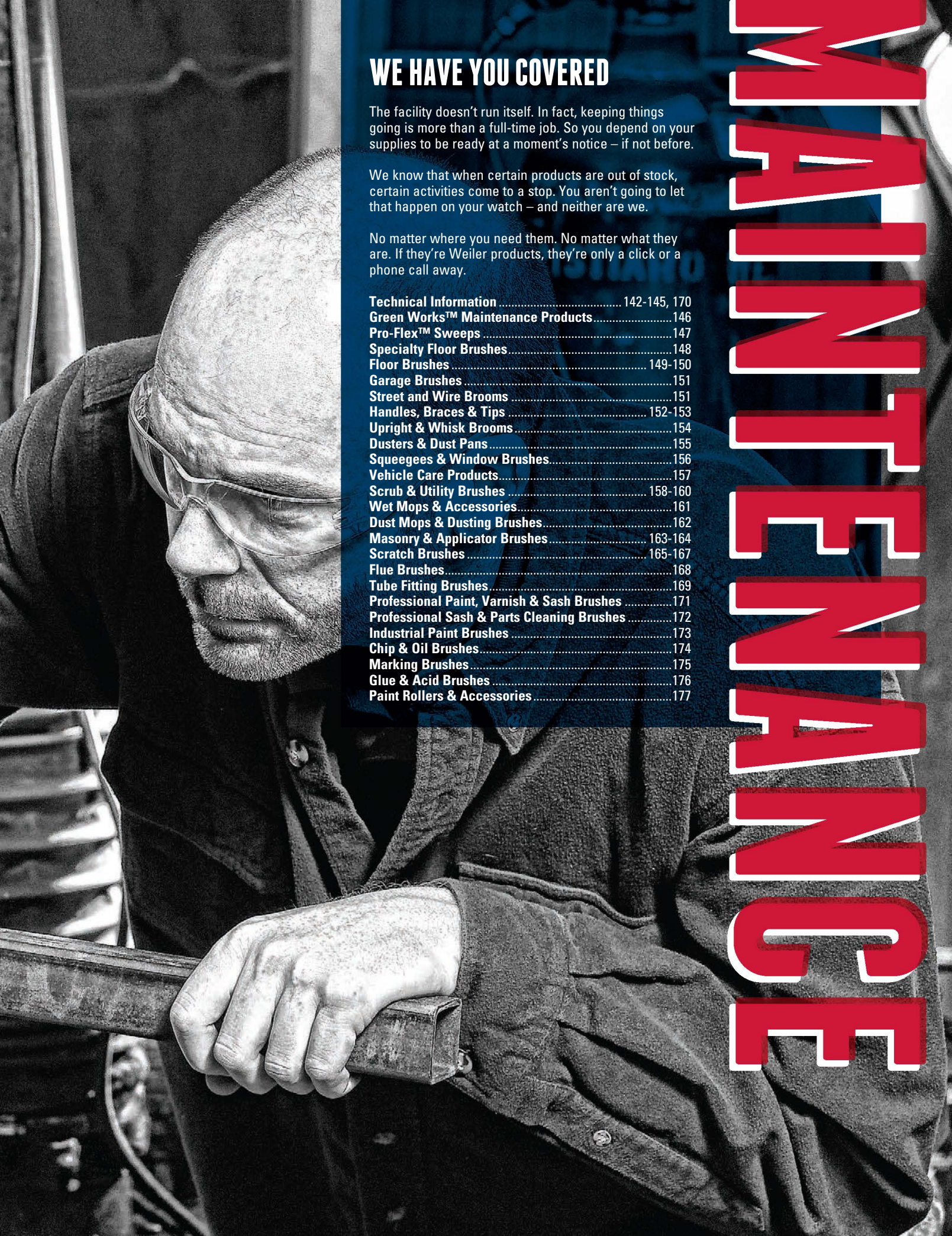

## WE HAVE YOU COVERED

The facility doesn't run itself. In fact, keeping things going is more than a full-time job. So you depend on your supplies to be ready at a moment's notice – if not before.

We know that when certain products are out of stock, certain activities come to a stop. You aren't going to let that happen on your watch – and neither are we.

No matter where you need them. No matter what they are. If they're Weiler products, they're only a click or a phone call away.

Technical Information .....	142-145, 170
Green Works™ Maintenance Products .....	146
Pro-Flex™ Sweeps .....	147
Specialty Floor Brushes .....	148
Floor Brushes .....	149-150
Garage Brushes .....	151
Street and Wire Brooms .....	151
Handles, Braces & Tips .....	152-153
Upright & Whisk Brooms .....	154
Dusters & Dust Pans .....	155
Squeegees & Window Brushes .....	156
Vehicle Care Products .....	157
Scrub & Utility Brushes .....	158-160
Wet Mops & Accessories .....	161
Dust Mops & Dusting Brushes .....	162
Masonry & Applicator Brushes .....	163-164
Scratch Brushes .....	165-167
Flue Brushes .....	168
Tube Fitting Brushes .....	169
Professional Paint, Varnish & Sash Brushes .....	171
Professional Sash & Parts Cleaning Brushes .....	172
Industrial Paint Brushes .....	173
Chip & Oil Brushes .....	174
Marking Brushes .....	175
Glue & Acid Brushes .....	176
Paint Rollers & Accessories .....	177

# MAINTENANCE



# SELECTING THE RIGHT BRUSH









## **P** PERFORMANCE LINE (INDUSTRIAL GRADE)

Engineered and manufactured to maximize performance and minimize operating costs in the most demanding surface conditioning applications. The use of superior construction, the highest quality materials and the most stringent manufacturing processes deliver the lowest cost-of-use and most consistent performance in heavy production environments.

## **V** VALUE LINE (PROFESSIONAL GRADE)

Weiler's value line is manufactured using similar product construction and the same exacting standards as other Weiler maintenance products, but engineered to provide cost-effective use specifically designed for the professional, providing a cost-effective price. Vortec Pro® maintenance products are an economical choice for the construction trades, low volume production shops and light-duty industrial MRO use.

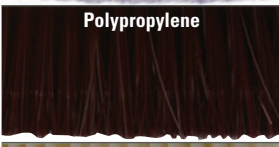
## FILL MATERIALS GUIDE

	Type	Advantages	Applications	Notes
ANIMAL	 Horsehair	<ul style="list-style-type: none"> <li>• Very durable and resilient</li> <li>• Naturally flagged tips</li> <li>• Resistant to high temperatures (to 370°F)</li> <li>• Can be blended with other materials</li> <li>• Fine texture</li> </ul>	<ul style="list-style-type: none"> <li>• Fine particles</li> <li>• Ideal for polished and smooth surfaces</li> <li>• Scratch-free sweeping</li> </ul>	<ul style="list-style-type: none"> <li>• Not for use on oily or wet surfaces</li> </ul>
NATURAL	 Tampico	<ul style="list-style-type: none"> <li>• Material holds water very well</li> <li>• Heat, alkali and acid resistant (to 283°F)</li> <li>• Soft to medium texture</li> <li>• Good durability</li> </ul>	<ul style="list-style-type: none"> <li>• Polishing, buffing and cleaning</li> <li>• Scrubbing and washing</li> <li>• Ideal for wet and dry applications</li> </ul>	<ul style="list-style-type: none"> <li>• Natural color is off white</li> <li>• Can be dyed or bleached</li> </ul>
	 Palmyra	<ul style="list-style-type: none"> <li>• Softer and finer texture than Bassine</li> <li>• More economical than Bassine</li> <li>• Medium to coarse texture</li> <li>• Good durability</li> </ul>	<ul style="list-style-type: none"> <li>• Used in garage, scrub, deck and patio brushes</li> <li>• Ideal for wet and dry applications</li> </ul>	<ul style="list-style-type: none"> <li>• Brown in color</li> </ul>
	 Bassine	<ul style="list-style-type: none"> <li>• Coarse, tough fibers</li> <li>• Excellent durability</li> </ul>	<ul style="list-style-type: none"> <li>• Heavy scrubbing and cleaning</li> <li>• Tasks requiring a tough, long-lasting natural fiber</li> </ul>	<ul style="list-style-type: none"> <li>• Dark brown in color</li> </ul>
	 Bass	<ul style="list-style-type: none"> <li>• Good flexibility</li> <li>• Very coarse, tough fibers</li> <li>• Excellent durability</li> </ul>	<ul style="list-style-type: none"> <li>• Heavy-duty cleaning applications</li> <li>• Use on rough surfaces</li> </ul>	<ul style="list-style-type: none"> <li>• Dark brown in color</li> </ul>
	 Nylon	<ul style="list-style-type: none"> <li>• Excellent durability</li> <li>• Resistant to most acids &amp; alkali</li> <li>• High water absorbency</li> <li>• Resistant to high temperatures (to 350°F)</li> <li>• Best man-made fiber to resist fatigue</li> </ul>	<ul style="list-style-type: none"> <li>• Heavy-duty industrial</li> <li>• Scrubbing and cleaning</li> <li>• Wet and dry applications</li> </ul>	<ul style="list-style-type: none"> <li>• May be level or crimped</li> </ul>
SYNTHETIC	 Polypropylene	<ul style="list-style-type: none"> <li>• Very durable</li> <li>• Acid, oil, bacteria and fungus resistant</li> <li>• Versatile</li> <li>• Resistant to high temperatures (to 225°F)</li> <li>• Will not absorb moisture</li> </ul>	<ul style="list-style-type: none"> <li>• Variety of medium to coarse industrial applications</li> </ul>	<ul style="list-style-type: none"> <li>• May be level or crimped</li> </ul>
	 Polystyrene	<ul style="list-style-type: none"> <li>• Extremely durable</li> <li>• Liquid and oil resistant</li> <li>• Resistant to temperatures (to 180°F)</li> <li>• Ends can be flagged</li> </ul>	<ul style="list-style-type: none"> <li>• Used in vehicle care brushes</li> <li>• Used in fruit and vegetable wash brushes</li> <li>• Wet and dry applications</li> </ul>	<ul style="list-style-type: none"> <li>• May be level or crimped</li> <li>• Not for use with sweeping compounds</li> </ul>
	 Recycled PET	<ul style="list-style-type: none"> <li>• Environmentally-friendly</li> <li>• Less landfill waste</li> </ul>	<ul style="list-style-type: none"> <li>• Fine, Medium &amp; Coarse</li> <li>• For a variety of applications</li> </ul>	<ul style="list-style-type: none"> <li>• Fill made from recycled water bottles</li> </ul>



# FLOOR BRUSH SELECTION GUIDE

Surface Type	Debris	Recommended Brush
Tile, linoleum, highly polished	Fine dust	Black horsehair
Smooth wood	Fine to medium dirt	Flagged silver polystyrene
Smooth concrete	Fine to medium dirt	Black polypropylene
Uneven or rough floors, heavy traffic areas	Medium to heavy dirt and debris	Black tampico
Rough concrete, asphalt	Heavy, caked dirt, grease, litter	Black tampico - inner row of steel wire or palmyra

## FLOOR BRUSH FEATURES

**Block:** Fill material is set into this part of the sweep.

### Synthetic Foam Block:

- Made with a synthetic cellular core surrounded by a solid skin.
- Will not crack, split, warp or house contaminating bacteria.
- Water, solvent and mild acid resistant.
- Lighter weight than hardwood blocks.

### Lacquered Hardwood Block:

- Made of natural, kiln-dried hardwood.
- Resists moisture.
- Helps prevent cracking, increasing brush life.

### Dense Fill:

- Set into the block and serves as the actual working part of the brush.
- More efficient sweeping.
- Longer brush life.

### Reorder Number:

- Shown on block.

### Two Handle Holes:

- Allows user to change sweeping direction to prevent the fill material from setting in one direction. Periodically changing sweeping direction increases the life of the brush.

### Flagged Tips:

- Each synthetic filament end is mechanically split, forming multiple tips which "pick up" fine dust and dirt particles. Horsehair has naturally tapered or flagged tips.

### Staggered Hole Pattern:

- Prevents gaps in the fill material so brush sweeps up all the dirt in its path.



### Center / Border Fill

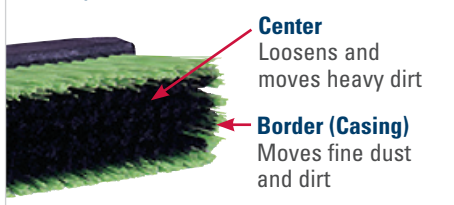

### Solid Brush Face with Flared Ends:

- The tufts of fill material on each end of a contractor, floor, garage or street brush are flared outward.
- Flared ends allow the brushing material to get into corners without marking or scraping the wall with the block.
- Prevents a gap in the middle of the brush.

## FLOOR BRUSH CARE

**Storage** - Floor brushes should be hung when not in use so no weight is against the fill material. This will help keep the shape and prolong the life of the brush.

**Handles** - The handle should be periodically re-positioned from one staff hole to the other to prevent fill material from setting in one position. The use of a brace will help prevent handle breakage. Perma-Flex™ (#44301) handles are guaranteed to outlast the life of the brush.

**Blocks** - Avoid knocking a wood block against the floor to remove embedded material, as this will damage the end of the block.

**Cleaning** - Synthetic filled brushes can be cleaned with detergent and water. Fiber filled brushes should be combed to remove dirt and other foreign material. Dip coarse natural fiber brushes in water to help prevent breakage due to dry fiber.

# GREEN WORKS™ MAINTENANCE PRODUCTS



36 billion water bottles end up in landfills every year. Help us make a difference!

Sustainable, recyclable, environmentally-friendly, Green - all of these come to mind with the new Green Works line from Weiler. Made from recycled or sustainable raw materials, the Green Works line is manufactured in a LEED (Leadership in Energy & Environmental Design) approved facility to ensure that even the production environment is environmentally-friendly. All of this, plus the same great performance! Every product is made to the quality levels you expect when you hear the name Weiler.

## Green Works Product Construction:

- Fill material is made out of recycled water bottles, giving a second life to these waste products and helping to clean up the environment.
- Rubberwood blocks are made from the wood of rubber trees that have ended their life cycle in the rubber production industry. We are putting the waste product of that industry to good use.
- Foam blocks are made from recycled plastics.
- Handles are made from bamboo - a very strong and durable natural resource that replenishes at a very rapid rate in the environment.



42352



42357



42360



42365



42368



42371



42375



42380

**P FLOOR SWEEPS** - Choose from flagged tips that pick-up fine dust and dirt to durable fibers that sweep heavy, caked dirt and debris.

Block Size	Block Type	Fill Material	Trim Length	Standard Pack	Item Number
<b>Fine Sweeping - For fine dust and dirt on smooth surfaces</b>					
24"	Recycled Black Foam	Recycled Grey Fill	3"	12	42352
24"	Renewable Rubberwood	Recycled Grey Fill	3"	12	42355
<b>Medium Sweeping - For general purpose sweeping on semi-smooth surfaces</b>					
24"	Recycled Black Foam	Recycled Blue Fill	3"	12	42353
24"	Renewable Rubberwood	Recycled Blue Fill	3"	12	42356
<b>Coarse Sweeping - For heavy dirt and debris on very rough surfaces</b>					
24"	Recycled Black Foam	Recycled Maroon Fill	3"	12	42354
24"	Renewable Rubberwood	Recycled Maroon Fill	3"	12	42357

Handle #42380 or #42381 are recommended for use with these sweeps.

**P STREET BROOM** - Ideal for wet or dry sweeping on streets, parking lots, loading docks and driveways.

Block Size	Block Type	Fill Material	Trim Length	Standard Pack	Item Number
16"	Renewable Rubberwood	Recycled Black Fill	6"	6	42360

Handle #42382 is recommended for use with this broom.

**P DUO SWEEP** - Heavy-duty upright with two handle holes - one straight and one angled.

Size	Block Type	Fill Material	Trim Length	Standard Pack	Item Number
9"	Recycled Black Foam	Recycled Yellow Fill	7"	12	42365

Handle #42383 is recommended for use with this sweep. See page 152 for details.

**P COUNTER DUSTER** - Ideal for quick clean-ups. Features a comfortable grip handle.

Block Size	Block Type	Fill Material	Trim Length	Overall Length	Std. Pack	Item Number
8"	Recycled Black Foam	Recycled Grey Fill	2-1/2"	13-1/8"	12	42368

**P SCRUB BRUSHES** - Designed to provide the most effective brushing and cleaning action.

Block Size	Type	Block Type	Fill Material	Standard Pack	Item Number
8"	Utility	Recycled Black Foam	Recycled Yellow Fill	12	42375
9"	Pointed Deck	Renewable Rubberwood	Recycled Yellow Fill	12	42373
10"	Deck	Renewable Rubberwood	Recycled Yellow Fill	12	42371
	Bi-Level	Recycled Black Foam	Recycled Yellow Fill	12	42372
20"	Utility	Recycled Black Foam	Recycled Yellow Fill	12	42376

Handle #42380 or #42381 are recommended for use with these scrub brushes.

**P SOLID BAMBOO HANDLES** - Very strong, abundant source material.

Length	Diameter	Tip Type	Standard Pack	Item Number
5'	7/8"	Threaded Wood	12	42380
5'	7/8"	Threaded Metal	12	42381
5'	1-1/8"	Tapered Wood	12	42382

Key:

**P** Performance line  
Industrial Grade

**V** Value line  
Professional Grade

## QUICK ASSEMBLY & UNBREAKABLE!

**Easy-to-Assemble:** The convenient and easy-to-assemble T-knob construction of the Pro-Flex Sweep takes less than 1 minute to assemble. The handle connects easily and securely to the broom head, and there's no need for a brace!

**Unbreakable:** Utilizing an advanced polymer technology, the Pro-Flex Sweep's unique handle/sweep connector flexes on impact, providing unbelievable shock absorbency...and it's unbreakable! Ideal for the most demanding applications on a construction site.

**More Maneuverable:** Without the need for a brace, the Pro-Flex Sweep is lighter, easy to maneuver and eliminates potential damage to low surface areas.

**The Pro-Flex Sweep... the strongest sweep on the market AND the easiest to assemble!**



Flexible connection makes these sweeps the strongest on the market!



The Pro-Flex Sweep's indestructible design will make it the last sweep you will ever buy!



44606

### **P** PRO-FLEX SWEEPS - Hardwood Block

Includes comfort grip Pro-Flex handle and scraper for removal of heavy, caked dirt and debris.

Block Size	Fill Material	Trim Length	Standard Pack	Item Number
<b>Convenient scraper attaches handle to sweep head for display and shipping purposes</b>				
24"	Flagged Grey Polystyrene Border with Stiff Black Polypropylene Center	3"	1	44600 ■
24"	Palmyra	4"	1	44601 ■
24"	Medium Maroon Polypropylene	3-1/4"	1	44604 ■
24"	Stiff Blue Polypropylene	3-1/4"	1	44606 ■

■ Packaged product available. See pages 131-141 for details.

## QUICK ASSEMBLY - NO TOOLS REQUIRED!



Remove nuts from broom assembly



Flip scraper and place over bolts



Place handle connector over bolts and tighten nuts securely

COATED ABRASIVES

NON-WOVEN ABRASIVES

POWER BRUSHES

NYLON BRUSHES

PACKAGED ITEMS

MAINTENANCE



# SPECIALTY FLOOR BRUSHES



Sweeping leaves from a garage floor.



44553



44584



44590

**P**

**CONTRACTOR BROOMS - Hardwood Block** - Heavy-duty brace included with all brooms. Ideal for construction sites and other heavy use environments.

Block Size	Fill Material	Trim Length	Standard Pack	Item Number
<b>Fine Sweeping - For fine dust and dirt on smooth surfaces</b>				
24"	Flagged Silver Polystyrene	3"	1	44553
<b>Medium Sweeping - For general purpose sweeping on semi-smooth surfaces</b>				
24"	Flagged Grey Polystyrene Border	3"	1	44581
30"	with Stiff Black Polypropylene Center			44582
<b>Coarse Sweeping - For heavy dirt and debris on very rough surfaces</b>				
24"	Palmyra	4"	1	44584
24"	Medium Maroon Polypropylene	3-1/4"	1	44587
24"	Stiff Blue Polypropylene	3-1/4"	1	44590
30"				44591

## NOTE



- For Contractor Brooms, use Handle No. 44635 (1-1/8" x 60").
- Handle not included in price - order handle separately. See page 152.
- Bolt to assemble broom is included with the broom, not with the handle.

**PERMA-SWEEP™ FLOOR BRUSHES** - Weiler offers color-coded floor sweeps to make product selection and identification easier. Constructed with foam blocks and synthetic filaments, these materials are durable, resist acid and bacteria and can be used in wet or dry sweeping applications.

**P**

**PERMA-SWEEP - Synthetic Foam Block** - Made of durable materials designed to resist acid and bacteria.

Block Size	Fill Material	Trim Length	Standard Pack	Item Number
<b>Fine Sweeping - For fine dust and dirt on smooth surfaces</b>				
18"	Flagged Green Polystyrene	3"	1	42163
24"				42164
<b>Medium Sweeping - For general purpose sweeping on semi-smooth surfaces</b>				
18"	Yellow Polypropylene	3"	1	42165
24"				42166
<b>Coarse Sweeping - For heavy dirt and debris on very rough surfaces</b>				
18"	Maroon Polypropylene	3"	1	42167
24"				42168

## NOTE



- For Perma-Sweep Floor Brushes, use Perma-Flex Handle No. 44301 (15/16" x 60") Guaranteed for the life of the brush!
- Handle not included in price - order handle separately. See page 152.

# FLOOR BRUSHES

Weiler offers a broad array of floor brushes in various sizes and fill materials for fine, medium and coarse sweeping applications. Choose from flagged tips that pick up fine dust and dirt to durable fibers that sweep heavy-caked dirt and debris. The lacquered hardwood blocks resist moisture and help prevent cracking, thereby increasing brush life.

## NOTE



- Handle No. 44300 (15/16" x 60") recommended for use with all Floor Brushes.
- Handle not included in price - order handle separately. See pages 152-153 for additional options.



Sweeping saw dust on a smooth surface.

## P FINE SWEEPS - Lacquered Hardwood Block

For dust and fine dirt on smooth surfaces: Tile, Wood, Linoleum, Marble, Ceramic Tile and Smooth Concrete.

Block Size	Fill Material	Trim Length	Standard Pack	Item Number	★ Combo Qty. Item Number
18"	Black Horsehair	3"	1	42001	44855
24"				42002	44856
18"	Black Horsehair and Black Polypropylene Blend	3"	1	42013	-
24"				42014	-
10"	Flagged Silver Polystyrene	3"	12	70312	-
18"				42041	44857
24"				42042	44858
36"				42098*	-

\* Brace included

★ Combo Packs include 12 sweeps per pack and 12 #44300 handles (not assembled).



42001



42042

## V VORTEC PRO® FINE SWEEPS - Lacquered Hardwood Block

Reliable and efficient sweeps at a value price.

Block Size	Fill Material	Trim Length	Standard Pack	Item Number
18"	Flagged Grey Polystyrene	3"	12	77013
24"				77014



77013

## P MEDIUM SWEEPS - Lacquered Hardwood Block

General purpose sweeping on semi-smooth surfaces: Wood, Smooth Concrete, Asphalt and Factory/Shop Floors.

Block Size	Fill Material	Trim Length	Standard Pack	Item Number	★ Combo Qty. Item Number
14"	Black Tampico	3"	1	42114	-
16"				42006	-
18"				42007	44859
24"				42008	44860
36"				42047*	-
18"	Horsehair Border with Black Tampico Center	3"	1	42016	-
24"				42017	-
36"				42049*	-
18"	Horsehair and Polystyrene Border with Black Polypropylene Center	3"	1	70067	-
24"				70068	-
18"	Black Polypropylene	3"	1	42035	44861
24"				42037	44862
36"				42095*	-

\* Brace included

★ Combo Packs include 12 sweeps per pack and 12 #44300 handles (not assembled).



42007

## V VORTEC PRO MEDIUM SWEEPS - Lacquered Hardwood Block

Reliable and efficient sweeps at a value price.

Block Size	Fill Material	Trim Length	Standard Pack	Item Number	★ Combo Qty. Item Number
18"	Dark Grey Polystyrene Border with Black Polypropylene Center	3"	1	25234	44851
24"				25235	44852
18"	Black Tampico	3"	1	25231	44853
24"				25232	44819

★ Combo Packs include 12 sweeps per pack and 12 #44300 handles (not assembled).



25234

COATED ABRASIVES

NON-WOVEN ABRASIVES

POWER BRUSHES

NYLON BRUSHES

PACKAGED ITEMS

MAINTENANCE



42135

**P**

**COARSE SWEEPS - Lacquered Hardwood Block**

For heavy dirt and debris on rough surfaces: Wood, Concrete, Asphalt and Brick.

Block Size	Fill Material	Trim Length	Standard Pack	Item Number	★ Combo Qty. Item Number
18"	Black Tampico with 1 row	3"	1	42134	44871
24"	Tempered Steel Wire in Center			42135	44872

★ Combo Packs include 12 sweeps per pack and 12 #44300 handles (not assembled).

**NOTE**



- Handle No. 44300 (15/16" x 60") recommended for use with all Floor Brushes.
- Handle not included in price - order handle separately. See pages 152-153 for additional options.

**STRIP BROOMS** - The corrosion-resistant frame is lightweight, resulting in less user fatigue! Efficient and economical, Strip Brooms make quick work of dirt and debris on all types of surfaces.



25299

**V**

**VORTEC PRO® STRIP BROOMS** - Economy brushes provide lasting, efficient service at minimal cost.

Block Size	Fill Material	Trim Length	Standard Pack	Item Number
<b>Fine Sweeping - For smooth surfaces</b>				
24"	Green Polypropylene	3"	12	25299
<b>Medium Sweeping - For semi-rough surfaces</b>				
18"	Red Polypropylene	3"	12	25290
24"				25291
<b>Coarse Sweeping - For rough surfaces</b>				
18"	Brown Polypropylene	3"	12	25294
24"				25295

**NOTE**



- For Strip Brooms, use Handle No. 25297 (15/16" x 60").
- Handle not included in price - order handle separately. See page 152.



25290



25294



73180

**P**

**DRIVEWAY COATERS** - For applying blacktop driveway and parking lot dressings; asphalt, sealers or roof coatings.

Block Size	Fill Material	Trim Length	Standard Pack	Item Number	★ Combo Qty. Item Number
10"	Black Tampico	2-5/8"	12	73180	-
18"	Palmyra	2"	12	73182*	44885

\* With squeegee

★ Combo Packs include 12 brushes per pack and 12 #75527 handles (not assembled).

**NOTE**



- Handle No. 75527 (7/8" x 48") recommended for Driveway Coaters.
- Handle not included in price - order handle separately. See pages 152-153 for additional options.



73182

Key:

**P** Performance line  
Industrial Grade

**V** Value line  
Professional Grade



**P GARAGE BRUSHES - Lacquered Hardwood Block**

For wet or dry sweeping heavy, caked dirt and debris on rough surfaces: Concrete, Garage/Factory Floors, Rough Wood, Sidewalks, Barns and Brick Surfaces. Solvent, oil, chemical and liquid resistant.

Block Size	Fill Material	Trim Length	Standard Pack	Item Number	★ Combo Qty. Item Number
16"	Palmyra	4"	1	42021	—
18"				42022	44867
24"				42023	44868
36"				42138*	—
18"	Maroon Polypropylene	3-1/4"	1	42025	—
24"				42026	—
36"				42149*	—

\* Brace included

★ Combo Packs include 12 sweeps per pack and 12 #44300 handles (not assembled).



Sweeping metal shavings from a shop floor.

**V VORTEC PRO® GARAGE BRUSHES - Lacquered Hardwood Block**

Reliable and efficient brushes at a value price.

Block Size	Fill Material	Trim Length	Standard Pack	Item Number	★ Combo Qty. Item Number
18"	Palmyra	4"	1	25241	44865
24"				25242	44866
18"	Maroon Polypropylene	3-1/4"	1	25238	44863
24"				25239	44864

★ Combo Packs include 12 sweeps per pack and 12 #44300 handles (not assembled).



42023



42025

**NOTE**



- Handle No. 44435 (1-1/8" x 60") recommended for use with all Garage Brushes.
- Handle not included in price - order handle separately. See pages 152-153 for additional options.

**P STREET BROOMS - Hardwood Block - Wide flared ends for sweeping close to curbs and walls. For heavy-duty wet or dry sweeping: Streets, Sidewalks, Loading Docks, Parking Lots, Driveways and all Asphalt Surfaces.**

Block Size	Fill Material	Trim Length	Standard Pack	Item Number	★ Combo Qty. Item Number
16"	Natural Palmyra	6-1/4"	6	70208	—
16"	Dyed Palmyra	6-1/4"	6	70209	—
16"	Bass & Palmyra Blend	6-1/4"	6	42032	44873
16"		7-1/4"		42099	—
16"	Brown Polypropylene	5-1/4"	6	42033	44874
18"				42173	—
24"				42174	—
16"	Orange Polypropylene	5-1/4"	6	70212	—
18"				42054	—
24"				42055	—
14"	White Polypropylene Fill Orange Block	4"	6	70210	—
16"				70211	—

★ Combo Packs include 12 brooms per pack and 12 #44020 handles (not assembled).



70209



42032



42033

**P WIRE BROOMS - Hardwood Block**

For sweeping or scrubbing concrete or stone floors, driveways, etc. Ideal for sweeping heavy chips and debris.

Block Size	Fill Material	Trim Length	Standard Pack	Item Number
14"	Flat Wire	5"	1	42030
16"	Round Wire	3-3/4"	6	70215

**NOTE**



- Street and wire brooms require a tapered tip handle.
- Handle No. 44020 (1-1/8" x 60") recommended for use with all Street & Wire Brooms.
- Use Spring-Loc Adapter to keep tapered wood handle securely fastened to the block.
- Handle not included in price - order handle separately. See pages 152-153 for adapter and handle.



42030

COATED ABRASIVES

NON-WOVEN ABRASIVES

POWER BRUSHES

NYLON BRUSHES

PACKAGED ITEMS

MAINTENANCE

# HANDLES, BRACES & TIPS

Weiler's wood and metal handles are constructed for long life. Handles are available in a large variety of styles and tips to fit a wide selection of block types. The following charts provide recommended uses for each style handle.



The Perma-Flex tip is guaranteed not to break when used with a Perma-Sweep.



44018



44020



44300



44301



25297



44635

## P WOOD HANDLES - Quality hardwood

Length	Diameter	Tip	Description	Std. Pack	Item No.
48"	7/8"	Threaded	Use with floor and garage brushes.	12	75527
48"	15/16"	Wood			44571
54"	15/16"				44572
60"	15/16"				44018
60"	1-1/8"				44019
72"	15/16"		44303		
11"	3/4"	Tapered	Use with masonry and roof brushes, street brooms, floor and deck scrubs and squeegees.	36	75528
48"	7/8"	Wood			44574
54"	1-1/8"				44573
60"	1-1/8"				44020
72"	1-1/8"				44306
48"	15/16"	Threaded	Heavy-duty metal tip provides additional strength.	12	75525
60"	15/16"	Metal			44300
60"	1-1/8"				44435
72"	15/16"				44302
48"	15/16"	Perma-Flex™	Durable threaded plastic tip guaranteed not to break when used with Perma-Sweep™ Floor Brushes.	12	75516
60"	15/16"				44301
60"	15/16"	—	Use with Strip Brooms.	12	25297
60"	1-1/8"	—	Use with Contractor Brooms.	12	44635



42383



44577



44578

## P METAL HANDLES - Reinforced, heavy-duty metal handles are available in two colors and optional foam cover.

Length	Diameter	Tip	Description	Std. Pack	Item No.
48"	3/4"	Threaded Plastic	Black metal with plastic hang cap.	12	42383
60"	15/16"	Threaded Metal	Yellow plastic coat with plastic hang cap.	12	44577
60"	15/16"	Threaded Metal	Black plastic coat with black foam cover and plastic hang cap.	12	44578



75555

## V VORTEC PRO® METAL HANDLES - Reliable and efficient handles at a value price.

Length	Diameter	Tip	Description	Std. Pack	Item No.
60"	15/16"	Threaded Plastic	Black plastic coat with convenient hang-up cap.	12	75555

**P METAL TELESCOPING AND FOUNTAIN TUBE HANDLES** - Use telescoping handles to shorten or extend the reach of the handle. Use fountain tube handles when a continuous flow of water is needed, i.e. car/truck washing.

Length	Diameter	Type	Use	Std. Pack	Item No.
6' extends to 12'	-	Telescoping	Window, wall and Vehicle wash brushes	6	44499
5'	7/8"	Fountain Tube	Vehicle wash brushes	12	44319



**P FIBERGLASS HANDLES** - Fiberglass handles are stronger than wood or metal. Virtually indestructible.

Length	Diameter	Tip	Description	Std. Pack	Item No.
60"	1"	Tapered/Threaded	Hollow handle	12	44561*
60"	1"	Threaded	Honeycomb core	12	44562
60"	1"	Threaded	All white	12	44563+

\* For use with both tapered and threaded holes + Approved for the food service industry

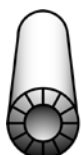

Fiberglass with polyethylene reinforced honeycomb core



Fiberglass hollow handle.



**P HANDLE ACCESSORIES**

Description	Use	Std. Pack	Item No.
Steel brace. Fits all handle sizes.	Reinforces & locks handle to block. (Standard with sweeps 30" and larger)	12	44021
Heavy-duty steel brace attaches to block with wood screws and wraps around handle. Fits all handle sizes.	Increases life of the brush by providing extra support for handle and block.	12	44290
Replacement handle thread. Made of heavy-duty fiberglass. For any 15/16" diameter handle.	Cut off damaged threads and slip this tip in place for a new handle.	12	44317
Tapered Adapter to tapered ends.	Converts threaded handle ends	12	75505
Spring Loc Adapter for any 1-1/8" diameter tapered wood handle for street brooms and window brushes.	Keeps tapered wood handles from separating from the block.	6	44624



Key:

- P** Performance line Industrial Grade
- V** Value line Professional Grade



# UPRIGHT AND WHISK BROOMS

Made of fine quality broom corn, fiber or synthetic material, Weiler's upright brooms and whisks are durable enough to meet all industrial and commercial applications.



Sweeping plastic and metal chips in a tool room

## **P** UPRIGHT BROOMS - Ideal for sweeping floors, reaching into corners, cleaning ceilings, etc.

Description	Fill Material	Trim Length	Overall Length	Standard Pack	Item Number
<b>Household Broom - Good Quality</b>					
4 sews - 7/8" handle	Corn & Fiber	15"	54"	12	44547
<b>Light Industrial Brooms - Better Quality</b>					
5 sews - 7/8" handle	Corn & Fiber	17"	57"	12	44548
5 sews - 7/8" handle	100% Corn	15"	56"	12	44009
6 sews - 1-1/8" handle	100% Black Corn	16"	56"	12	70304
<b>Janitor's Broom - Best Quality</b>					
5 sews - 1-1/8" handle Wire banded	Corn & Fiber	17"	57"	12	70308
<b>Warehouse Broom - Heavy-Duty</b>					
4 sews - 1-1/8" handle Wire banded	Corn & Fiber	18"	57"	12	44008



44009



44305

## **P** ANGLE BROOM - Angled trim allows access to corners, under low cabinets and other hard-to-reach areas.

Description	Fill Material	Trim Length	Overall Length	Standard Pack	Item Number
Large Plastic 12" sweep face	Flagged Plastic	7-1/2"-6"	54"	12	44305

## **V** VORTEC PRO® ANGLE BROOM - Reliable and efficient broom at a value price.

Description	Fill Material	Trim Length	Overall Length	Standard Pack	Item Number
Small Plastic 8" sweep face	Flagged Plastic	3-7/8"-4-1/2"	54"	12	75160



70325

## **P** CAP BROOMS - Metal top for added durability. Ideal for wet or dry applications.

Description	Fill Material	Trim Length	Overall Length	Standard Pack	Item Number
Metal Cap - Wire banded 12" sweep face	Palmyra	10"	55"	6	44007
Metal Cap - Wire banded 12" sweep face	Brown Poly	10"	55"	6	70325
Track & Switch Steel chisel point on handle end	Palmyra	8"	55"	6	70324



70300

## **V** VORTEC PRO LOBBY BROOMS - Reliable and efficient brooms at a value price.

Description	Fill Material	Trim Length	Overall Length	Standard Pack	Item Number
Plastic Cap - 8" sweep face	Flagged Plastic	5"	36"	12	44546
Toy/Lobby - 3 sews, 7/8" handle	Corn & Fiber	11"	40"	12	70300



44266

## **P** WHISK BROOMS - For fast, efficient clean-up.

Use	No. of Sews	Fill Material	Trim Length	Overall Length	Std. Pack	Item No.
General purpose - all applications	3	Corn & Fiber	10"	12-1/2"	12	44266
Sweeping coarse & heavy material	2	Palmetto	7"	9-1/4"	12	44099
Coarse sweeping of hot chips	-	Bassine	5-1/4"	10-1/4"	12	44103

# DUSTERS AND DUST PANS

Whether cleaning fine particles or heavy debris, Weiler has a Counter Duster to do the job. These brushes are available in a wide selection of fill materials and have comfortably shaped blocks in wood or foam. Also choose from an array of Dust Pans to meet the application requirements.



Cleaning up oil absorbent from a shop floor.

## **P** COUNTER DUSTERS - For clean up in hard-to-reach areas.

Fill Material	Trim Length	Brush Length	Overall Length	Block Type	Std. Pack	Item No.
<b>Horsehair</b>						
Horsehair	2-1/4"	8"	13-1/4"	Wood	12	44003
	2-1/4"	9"	14-1/4"			44351
Black Horsehair and Fiber Mix	2-1/2"	8"	13-1/2"	Wood	12	71019
<b>Synthetic</b>						
Flagged Silver Polystyrene	2-1/2"	8"	13-1/4"	Wood	12	44354
Black Polystyrene	2-1/2"	8"	13-1/4"	Wood	12	25252
Orange Polystyrene	2"	9"	14"	Foam	12	42213
<b>Natural Fiber</b>						
Black Tampico	2-1/2"	8"	13-1/4"	Wood	12	25251
Tri-colored Tampico	2-1/2"	8"	13-1/2"	Wood	12	44004



44003



42213



44004

## **P** DUST PANS - Durable, industrial grade - For quick clean-ups.

Description	Height	Width	Depth	Std. Pack	Item No.
Heavy-duty 20 gauge steel Black enamel finish	-	12"	13-1/2"	12	71078
Extra wide - Heavy-duty 20 gauge steel; Black enamel finish	-	16"	15"	12	71079
Lobby Dust Pan - Black enamel metal hopper; Aluminum handle	39-1/2"	12"	9"	6	71081



71078



71077

## **V** VORTEC PRO® DUST PANS - Reliable and efficient pans at a value price.

Description	Height	Width	Depth	Std. Pack	Item No.
Molded plastic	-	12-1/4"	12"	12	71077
Lobby Dust Pan Molded plastic hopper Aluminum handle	39-1/2"	12"	11"	6	71080



71080

Key:

**P** Performance line  
Industrial Grade

**V** Value line  
Professional Grade

COATED ABRASIVES

NON-WOVEN ABRASIVES

POWER BRUSHES

NYLON BRUSHES

PACKAGED ITEMS

MAINTENANCE

# SQUEEGEES & WINDOW BRUSHES

Squeegees deliver fast, efficient cleaning. Weiler provides a variety of non-scratching floor and window squeegees and window brushes. Designed for high durability.



Cleaning a window with a window squeegee.



45507

## **P** FLOOR SQUEEGEES - Heavy-duty construction, iron handle socket.

Description	Length	Type	Standard Pack	Item Number
Black rubber blade for rough, heavy use	18"	Straight	6	45506
	24"			45507
	30"			45534
	36"			75202
Black rubber blade for rough, heavy use	24"	Curved	6	45510
	30"			45535
	36"			45511



45510

## **P** WINDOW SQUEEGEES - Rust-proof handle socket and frame.

Description	Length	Standard Pack	Item Number
One piece frame with hard rubber section joined with a soft, red rubber blade.	6"	12	45537
	12"		45500
	14"		45538



45500

### NOTE



- All squeegees require a tapered tip handle.
- Handle No. 44020 (1-1/8" x 60") recommended for use with all Squeegees.
- Use Spring-Loc Adapter to keep tapered wood handle securely fastened to the block.
- Handle not included in price - order handle separately. See pages 152-153 for adapter and handle.



25271

## **V** ROUND STYLE WINDOW BRUSH - Two threaded handle holes High quality, non-scratching brushes used for industrial window washing.

Description	Block Size	Block	Trim Length	Standard Pack	Item Number
Flagged Gold Polystyrene	4-1/2"	Plastic	2-1/2"	12	25271

### NOTE



- Handle No. 44019 (1-1/8" x 60") recommended for use with #25271 & #73003 Window Brushes.
- Handle not included in price - order handle separately. See page 152 for handle.

Key:

**P** Performance line  
Industrial Grade

**V** Value line  
Professional Grade



# VEHICLE CARE PRODUCTS

Weiler's line of vehicle care brushes meets the cleaning needs of car and truck fleets. Brushes are also popular in the marine industry. All products are designed to provide professional results.



Washing a car with a vehicle wash brush and fountain tube handle.

**P VEHICLE WASH BRUSHES** - Protective bumper - Foam block with two handle holes. Can be used with flow-through handle #44319 on page 153.

Block Size	Fill Material	Trim Length	Standard Pack	Item Number	★ Combo Qty. Item Number
9-1/2" x 2-3/4"	Grey Fiber	2-1/2"	12	44318*	—
9-1/2" x 2-3/4"	Flagged White Polystyrene	2-1/2"	12	44510	44875
9-1/2" x 2-3/4"	Flagged Orange Polystyrene	2-1/2"	12	42210	—
9-1/2" x 2-3/4"	Flagged Green Polystyrene	2-1/2"	12	73146	—

\* May scratch smooth or high gloss surfaces, use polystyrene filled products for these surfaces.

★ Combo Packs include 12 brushes per pack and 12 #44319 handles (not assembled).



44510

**P SCHOOL BUS BRUSH** - Easily sweeps between school bus seats. Lacquered hardwood block with one threaded handle hole. Use handle #44571 on page 152.

Block Size	Fill Material	Trim Length	Standard Pack	Item Number
10" x 2-1/2"	Flagged Silver-grey Polystyrene	3"	12	70312



70312

**P UPHOLSTERY/SPOTTING BRUSH** - Shaped plastic handle  
Wet & dry cleaning, prespotting, carpet touch-up, etc.

Block Size	Fill Material	Trim Length	Overall Length	No. of Rows	Std. Pack	Item Number
8-1/2" x 2-9/16"	.016 Crimped Polypropylene	5/8"	8-1/2"	8 x 9	12	44307



44307

**P SPOKE BRUSH** - Ideal for cleaning spokes or confined spaces.

Length of Brush Part	Fill Material	Brush Part	Overall Length	Standard Pack	Item Number
10"	White Tampico	2-7/8" tapered to 1-1/4"	15"	12	44315



44315

**P TIRE CLEANING BRUSHES** - Foam block - Used for cleaning sidewalls of tires.

Block Size	Fill Material	Trim Length	Overall Length	No. of Rows	Std. Pack	Item No.
8-1/2" x 2-9/16"	.008 Brass	5/8"	8-1/2"	8 x 9	12	99593
7" x 1-9/16"	.008 Brass	5/8"	7"	6 x 8	12	73156



99593

COATED ABRASIVES

NON-WOVEN ABRASIVES

POWER BRUSHES

NYLON BRUSHES

PACKAGED ITEMS

MAINTENANCE

# SCRUB BRUSHES



Scrubbing a stainless steel sink.

A broad range of high quality scrub and utility brushes are available from Weiler. From quick cleaning to heavy-duty scrubbing, Weiler's brushes are designed to provide the most effective brushing and cleaning action.



44395



44024



44023



44026



44434



44692

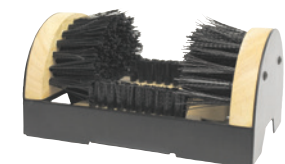

44391

## P HAND SCRUB BRUSHES - Heavily filled for heavy-duty scrubbing.

Block Size	Fill Material	Trim Length	Block Type	Standard Pack	Item Number
6"	White Polypropylene	1-1/8"	Iron Style - Plastic	12	44395
7-1/4"	Palmyra	1"	Square - Wood	24	72034
8"	White Tampico	1-1/8"	Square - Wood	12	44024
	White Tampico	1"			72058*
	Palmyra	1-1/8"			44025
8-1/4"	White Tampico	1-1/8"	Square - Wood	12	73111+
9"	White Tampico	1-1/8"	Pointed - Wood	12	44023

\* Threaded handle hole

+ Tapered handle hole

## P DECK SCRUB BRUSHES - Excellent for scrubbing decks or floors. One threaded and one tapered handle hole. Can be used with threaded handle #44018 or tapered handle #44020 on page 152.

Block Size	Fill Material	Trim Length	No. of Rows	Block Type	Standard Pack	Item Number
9"	Palmyra	2"	5 x 14	Wood	12	44428
	Tampico					44429
10"	Palmyra	2"	6 x 18	Wood	12	44026
	Tampico					44028
	Polypropylene					44434
12"	Palmyra	2"	6 x 20	Wood	12	44027
	Tampico					44029
	Polypropylene					44438

## P BI-LEVEL SCRUB BRUSHES - The bi-level design allows the brush to stay in contact with the surface. Can be used with flow-through handle #44319 on page 153 or the Perma-Flex handle #44301 on page 152.

Block Size	Fill Material	Trim Length	Block Type	Standard Pack	Item Number
10"	Stiff Crimped Blue Polypropylene	1-3/4"	Foam	6	44692
10"	Flagged White Polystyrene	2-3/4"	Foam	6	44699
10"	Fine Green Nylex	2-3/4"	Foam	12	44693

## V VORTEC PRO® BOOT BRUSH - Reliable and efficient brush at a value price.

Size	Description	Item Number
9" x 6"	Boot Cleaning Brush - Metal Frame - Wood Block - Black Nylon Fill	44391

# SCRUB BRUSHES & UTILITY BRUSHES



Removing stubborn dirt, grime and mildew from a tiled surface with a grout detail brush.

## **P** UTILITY SCRUB BRUSHES - For general scrubbing in factories, kitchens, institutions, etc.

Overall Length	Fill Material	Trim Length	Block Type	Standard Pack	Item Number
8"	Palmyra	2"	Wood	12	72086
	Yellow Polypropylene				44013
	White Tampico				44014
20"	Palmyra	2"	Wood	12	72101
	Yellow Polypropylene				44016
	White Tampico				44017

## **P** UTILITY SCRUB BRUSHES - Chemical and water resistant, will not warp or crack.

Overall Length	Fill Material	Trim Length	Block Type	Standard Pack	Item Number
8"	Palmyra	2"	Foam	12	79101
	Yellow Polypropylene				79120
	White Tampico				79100
20"	Palmyra	2"	Foam	12	79107
	Yellow Polypropylene				79109
	White Tampico				44663



44014



44016

## **P** UTILITY SCRUB BRUSHES - Designed for high temperature cleaning, ideal for food service.

Overall Length	Fill Material	Trim Length	Block Type	Standard Pack	Item Number
8"	White Nylon	2"	Plastic	12	44416
20"	White Nylon	2"	Plastic	12	44418



79120



79107

## **V** VORTEC PRO® UTILITY SCRUB BRUSHES - Ideal for general purpose cleaning.

Overall Length	Fill Material	Trim Length	Block Type	Standard Pack	Item Number
8"	Tampico	2"	Foam	12	25262
20"	Tampico	2"	Foam	12	25263



44418

## **P** GROUT DETAIL BRUSH - Use for removing stubborn dirt, grime and mildew from tiled surfaces.

Block Size	Fill Material	Trim Length	Standard Pack	Item Number
8-1/2"	Stiff Black Nylon	7/8"	24	73233



25262

## **P** BOWL BRUSH - 2" Trim Length - For thorough, efficient cleaning.

Brush Part	Fill Material	Handle	Overall Length	Standard Pack	Item Number
5-3/4" x 4-3/4"	Black Nylon	Plastic	21"	12	75068



73233



75068

Key:

**P** Performance line Industrial Grade      **V** Value line Professional Grade

COATED ABRASIVES

NON-WOVEN ABRASIVES

POWER BRUSHES

NYLON BRUSHES

PACKAGED ITEMS

MAINTENANCE





44001

**P** **PROFESSIONAL BOWL BRUSHES** - Hardwood handle and natural fiber - For thorough cleaning.

Brush Part	Fill Material	Diameter	Overall Length	Standard Pack	Item Number
6" x 5"	White Tampico	2"	20"	12	44001*
6-1/2"	Tampico	3-1/4"	23"	12	75060

\* Foam handle



75000

**V** **VORTEC PRO® BOWL BRUSH SET** - 2" Trim Length - Reliable and efficient brushes at a value price.

Brush Part	Fill Material	Handle	Overall Length	Standard Pack	Item Number
3-1/2" x 3-3/4"	White Plastic	Plastic	14-1/2"	6	75000



44314

**V** **VORTEC PRO NAIL BRUSH** - Great for use in shop or industrial settings.

Block Size	Fill Material	Trim Length	No. of Rows	Block Type	Standard Pack	Item Number
4-3/4" x 1-1/2"	Plastic	3/4"	4 x 15	Wood	36	44314



99594

**P** **BOTTLE WASHING BRUSH** - Brush shape enables access to hard-to-reach areas when cleaning.

Length of Brush Part	Fill Material	Handle	Overall Length	Standard Pack	Item Number
6"	Black Horsehair	Wood	16"	12	99594



75085

**V** **VORTEC PRO BOTTLE WASHING BRUSH** - Reliable and efficient brush at a value price.

Length of Brush Part	Fill Material	Handle	Overall Length	Standard Pack	Item Number
5-1/2" x 2-3/8"	White Nylon	Twisted-in-wire	17"	24	75085



44111

**P** **NYLON TUBE BRUSHES** - Loop handle, Straight black nylon fill.

Diameter	Fill Diameter	Brush Part	Stem Diameter	Overall Length	Standard Pack	Item Number
1/4"	.005	2"	3/32"	6-1/4"	36	44110
3/8"	.005	2"	3/32"	6-1/4"	36	44213
1/2"	.010	3"	1/8"	8-1/2"	36	44111
3/4"	.012	3"	1/8"	8-1/2"	36	44112
1"	.014	4"	5/32"	12-1/4"	36	44113
1-1/4"	.014	4"	5/32"	13"	36	44114
2"	.014	5"	3/16"	16-3/4"	36	44115



44115



44316

**P** **PERCOLATOR BRUSH** - Straight white nylon fill  
Ideal for internal cleaning in industrial, laboratory and food service.

Diameter	Fill Diameter	Brush Part	Stem Diameter	Overall Length	Standard Pack	Item Number
7/16"	.010	3-1/2"	5/32"	11-1/2"	10	44316



75570

**P** **VAT BRUSH** - For valves, outlets, small tanks, beverage dispensers & coffee urns.  
Can be used with the Perma-Flex handle #44301 on page 152.

Fill Material	Block Type	Overall Length	Standard Pack	Item Number
White Nylon	White Nylon	8"	1	75570

# WET MOPS & ACCESSORIES

Our wet mops are made with industrial grade cotton and can be laundered. They will not scratch floors or unravel.



Use the Combo Bucket with 12 to 32 oz. mop heads

## P WET MOP HEADS - Durable, ideal for all-purpose cleaning. Can be laundered.

Weight	Material	Standard Pack	Item Number
<b>Cut End</b>			
16 oz.	8-ply tight twist cotton	12	75102
20 oz.			75103
24 oz.			75104
32 oz.			75105
Small	4-ply high bulk cotton economy	12	75170
Medium			75171
Large			75172
X-Large			75173
<b>Loop End</b>			
Small	4-ply tight twist cotton	12	75180
Medium			75181
Large			75182



75102



75171

COATED ABRASIVES

NON-WOVEN ABRASIVES

POWER BRUSHES

NYLON BRUSHES

PACKAGED ITEMS

MAINTENANCE

## P WET MOP HANDLES - Industrial Grade. Hardwood handle with plated metal heads.

Description	Size	Standard Pack	Item Number
Quick-Change Plastic Head	54" x 15/16"	12	75140
Screw Type	54" x 1-1/8"	12	75131
Spring Type	54" x 1-1/8"	12	75132
Jaw Type	54" x 1-1/8"	12	75130



75140



75131

## P ONE-PIECE COTTON DECK MOPS - Industrial grade. Mop head securely tied to handle.

Description	Weight	Standard Pack	Item Number
#10	10 oz.	12	75096
#12	12 oz.	12	75097
#16	16 oz.	12	75109
#20	20 oz.	12	75098
#24	24 oz.	12	75110



75109

## V VORTEC PRO® COMBO BUCKET - One-piece construction that will not rust, fade, crack, peel, chip, dent or warp. Wringer fits all sizes of plastic or metal buckets.

Bucket Size	Wringer	Standard Pack	Item Number
36 qt.	12-32 oz.	1	36666



36666

Key:

**P** Performance line  
Industrial Grade

**V** Value line  
Professional Grade

# DUST MOPS & DUSTING BRUSHES

Our dust mops are made with industrial grade cotton and can be laundered. They will not scratch floors or unravel.



Cleaning a corner with a dust mop.



75117

**P** **PROFESSIONAL DUST MOPS** - Tie-on style, 4-ply cotton. Can be laundered.

Mop Size	Frame Size	Standard Pack	Item Number
24"	5" x 24"	12	75117
36"	5" x 36"	12	75118



75138

**P** **PROFESSIONAL DUST MOP FRAMES** - Heavy-duty full swivel frame.

Mop Size	Frame Size	Standard Pack	Item Number
24"	5" x 24"	12	75137
36"	5" x 36"	12	75138



75133

**P** **PROFESSIONAL DUST MOP HANDLE** - Heavy-duty clamp-on style.

Length	Diameter	Standard Pack	Item Number
60"	15/16"	12	75133



73050

**P** **RADIATOR BRUSHES** - 24" Overall Length. Ideal for cleaning radiators and narrow, hard-to-reach places.

Fill Material	Type	Brush Part	Trim Length	Overall Length	Std. Pack	Item No.
Black Horsehair	Foam Handle	9-1/2"	2-1/2"	23-13/16"	12	73050
Black Horsehair	Twisted-in-wire handle	7-1/2"	2-1/2"	24-11/16"	12	73055



73055



71076

**P** **WALL DUSTING BRUSH** - For dusting ceilings, valances, high moldings and other hard-to-reach places. Twisted-in-wire construction with plastic handle.

Fill Material	Overall Length	Trim Length	Standard Pack	Item Number
Horsehair	12" x 5"	2-3/4"	2	71076



# MASONRY & APPLICATOR BRUSHES

Weiler's full line of Masonry & Applicator Brushes covers everything from the ground up - cement finishing and stippling brushes for texturing and applying cement and asphalt; whitewashing and masonry brushes for applying cement, water paints and liquid waterproofing materials on concrete block and masonry walls; smoothing brushes for applying wallpaper; and roof brushes for spreading roofing tar and coatings.



Applying waterproofing material with a masonry brush.

**P** **KNOT-TYPE ROOF BRUSHES** - For application of roof coatings. Can be used with tapered handle #44574 on page 152.

Block Size	Fill Material	Trim Length	No. of Knots	Standard Pack	Item Number	★ Combo Qty. Item Number
6-1/4"	Tampico	3-1/4"	3	12	44010	44883

★ Combo Packs include 12 brushes per pack and 12 #44574 handles (not assembled).



44010

**P** **BLOCK-TYPE ROOF BRUSHES** - For application of roof coatings. Can be used with tapered handle #44574 or threaded handle #75527 on page 152.

Block Size	Fill Material	Trim Length	No. of Knots	Standard Pack	Item Number	★ Combo Qty. Item Number
7"	White Tampico One tapered handle hole	2"	5	12	44011	44884
7"	White Tampico One threaded handle hole	2"	5	12	73195	-

★ Combo Packs include 12 brushes per pack and 12 #44574 handles (not assembled).



44011

**P** **MASONRY BRUSHES** - Useful tools for applying cement, waterpaints and liquid waterproofing materials on masonry walls. Handle attached.

Block Size	Fill Material	Trim Length	Overall Length	No. of Rows	Standard Pack	Item Number
7"	White Tampico	3-1/4"	11"	2	12	44032
6"	Solvent Resistant Polypropylene	3-1/4"	11-1/2"	3	12	74020
4"	White Tampico	3"	10-3/4"	4	12	74004
6-1/2"	White Tampico	3-1/2"		4	12	44031
6"	White Tampico	3"	10-1/2"	5	12	74002
6-1/2"	White Tampico	4"	11-3/4"	5	12	44448



44031



44448

**P** **WHITWASH BRUSHES** - Two tapered handle holes allow user to choose the correct brush angle needed. Can be used with tapered handle #75528 on page 152.

Block Size	Fill Material	Trim Length	No. of Rows	Standard Pack	Item Number
6"	White Tampico	2-5/8"	2	12	74048
7"	White Tampico	2-5/8"	2	12	44034
					74053*

\* Includes a 12" tapered wood handle.



44034

Key:

**P** Performance line  
Industrial Grade

**V** Value line  
Professional Grade

COATED ABRASIVES

NON-WOVEN ABRASIVES

POWER BRUSHES

NYLON BRUSHES

PACKAGED ITEMS

MAINTENANCE



**P** **ACID BRUSH - Detachable handle** - For the application of Kalsomine, cold water, acid and water repellents to concrete and other rough surfaces.

Block Size	Fill Material	Trim Length	No. of Rows	Standard Pack	Item Number
7"	White Tampico	3-1/2"	3	12	74015



**P** **ACID SCRUB BRUSH - Hardwood block** - Tapered handle hole. Recommended for applying sealcoating, cement slurry, water-proofing, etc.

Block Size	Fill Material	Trim Length	Standard Pack	Item Number
8-1/4" x 2-3/4"	White Tampico	1-1/8"	12	73111

NOTE: Handle not included - can be used with tapered handle #44574 on page 152.



**P** **CEMENT FINISHING BRUSHES - Hardwood block** - Ideal for creating texture to newly poured cement and for applying coatings on asphalt or concrete. Use handle #44303 on page 152.

Block Length	Fill Material	Trim Length	No. of Knots	Standard Pack	Item Number	★ Combo Qty. Item Number
24"	Black Polypropylene	2-1/4"	3	6	79251	—
24"	Black Polypropylene	3-1/4"	3	6	79252	44879
36"	Black Polypropylene	3-1/4"	3	6	79253	44880
24"	Horsehair	2-1/2"	3	6	79255	44881
36"	Horsehair	2-1/2"	3	6	79256	44882

★ Combo Packs include 12 brushes per pack and 12 #44303 handles (not assembled).



**P** **SMOOTHING BRUSH - Hardwood block** - For smoothing wallpaper.

Block Length	Fill Material	Trim Length	Standard Pack	Item Number
12"	White Tampico	2"	12	74078

*Creating texture on newly poured concrete with a cement finishing brush.*



Key:

**P** Performance line  
Industrial Grade

**V** Value line  
Professional Grade

# SCRATCH BRUSHES

Weiler's extensive Scratch Brush offering includes many block and handle types and sizes. The wide variety of fill materials available assures the right brush for the right job. Common applications are cleaning dirt, rust, scale, chips and paint; plating and welding operations.



Removing excess concrete from the surface of a steel support plate.

## **P** CURVED HANDLE SCRATCH BRUSHES - **Hardwood block** - Ideal for cleaning and prepping surfaces.

Block Size	Brush Length	Number of Rows	Trim Length	Standard Pack	Item Number
<b>.012 Steel Wire</b>					
13-3/4" x 1-1/8"	5-1/4"	3 x 14	1-1/4"	12	44594*
14" x 7/8"	5-1/2"	3 x 19	1-3/16"	12	44053
14" x 1-1/8"	6"	4 x 18	1-3/16"	12	44056
<b>.012 Steel Wire with Scraper</b>					
14" x 7/8"	5-1/2"	3 x 19	1-3/16"	12	44055
14" x 1-1/8"	6"	4 x 18	1-3/16"	12	44058
<b>.012 Stainless Steel Wire</b>					
13-3/4" x 1-1/8"	5-1/4"	3 x 14	1-1/4"	12	44432*
14" x 7/8"	5-1/2"	3 x 19	1-3/16"	12	44054
14" x 1-1/8"	6"	4 x 18	1-3/16"	12	44057

\* V-Groove



44594  
Top View



44053



44055



25150



44063



44065



73218

## **V** VORTEC PRO® CURVED HANDLE SCRATCH BRUSHES -

Reliable and efficient brushes at a value price.

Block Size	Brush Length	Number of Rows	Trim Length	Standard Pack	Item Number
<b>.012 Steel Wire</b>					
13-1/2" x 1"	6"	3 x 19	1"	12	25150
14" x 1-1/8"	6"	4 x 18	1"	12	25201
<b>.012 Stainless Steel Wire</b>					
13-1/2" x 1"	6"	3 x 19	1"	12	25154
14" x 1-1/8"	6"	4 x 18	1"	12	25202

## **P** SHOE HANDLE SCRATCH BRUSHES - **Hardwood block** - Ideal for cleaning and prepping surfaces.

Block Size	Brush Length	Number of Rows	Trim Length	Standard Pack	Item Number
<b>.012 Steel Wire</b>					
10" x 3/8"	5"	1 x 17	1-1/16"	12	44100
10" x 5/8"	5"	2 x 17	1-3/16"	12	44061
10" x 1-1/8"	5"	4 x 16	1-3/16"	12	44063
11"	5"	4 x 16	1-3/16"	12	73217 •
<b>.012 Steel Wire with Scraper</b>					
10" x 1-1/8"	5"	4 x 16	1-3/16"	12	44065
<b>.012 Stainless Steel Wire</b>					
10" x 3/8"	5"	1 x 17	1-1/16"	12	44101
10" x 3/8"	5"	1 x 17	3/4"	12	44235
10" x 5/8"	5"	2 x 17	1-3/16"	12	44062
10" x 1-1/8"	5"	4 x 16	1-3/16"	12	44064
11"	5"	4 x 16	1-3/16"	12	44299 •
<b>.012 Brass Wire</b>					
11"	5"	4 x 16	1-1/4"	12	73218 •

• Plastic block

## **V** VORTEC PRO SHOE HANDLE SCRATCH BRUSHES -

Reliable and efficient brushes at a value price.

Block Size	Brush Length	Number of Rows	Trim Length	Standard Pack	Item Number
<b>.012 Steel Wire</b>					
10" x 1"	5"	4 x 16	1"	12	25100
<b>.012 Stainless Steel Wire</b>					
10" x 1"	5"	4 x 16	1"	12	25104



25100

COATED ABRASIVES

NON-WOVEN ABRASIVES

POWER BRUSHES

NYLON BRUSHES

PACKAGED ITEMS

MAINTENANCE





**P HEAVY-DUTY SCRATCH BRUSH WITH SCRAPER** - .012 Steel Wire

Ideal for cleaning and prepping surfaces.

Block Size	Brush Length	Number of Rows	Trim Length	Standard Pack	Item Number
11-1/2" x 1-1/2"	5-1/2"	4 x 11	1-1/2"	12	44069

**V VORTEC PRO® HEAVY-DUTY SCRATCH BRUSH WITH SCRAPER** - .012 Steel Wire

Reliable and efficient brushes at a value price.

Block Size	Brush Length	Number of Rows	Trim Length	Standard Pack	Item Number
11-1/2" x 1-1/2"	5"	4 x 11	1-5/8"	12	25211



**P PLATER'S BRUSHES - Hardwood block** - For general cleaning in the plating, metal finishing, aircraft and missile industries. Also used with inert arc aluminum welding.

Block Size	Brush Length	Number of Rows	Trim Length	Standard Pack	Item Number
<b>Tampico</b>					
13" x 1-1/4"	5-1/4"	4 x 18	1"	12	44076
<b>Nylon</b>					
13" x 1-1/8"	5-1/4"	4 x 18	1"	12	44077
<b>.006 Steel Wire</b>					
10" x 1-1/8"	5"	4 x 16	1"	12	44117
13" x 7/8"	5-1/2"	3 x 19	1"	12	44116
<b>.006 Stainless Steel Wire</b>					
10" x 1-1/8"	5"	4 x 18	1"	12	44240
13" x 7/8"	5-1/2"	3 x 19	1"	12	44660
13" x 1-1/8"	5-1/2"	4 x 19	1"	12	44232
<b>.006 Brass Wire</b>					
10" x 1-1/8"	5"	4 x 18	1"	12	44119
13" x 7/8"	5-1/2"	3 x 19	1"	12	44118



**P SMALL HAND SCRATCH BRUSHES** - Ideal for cleaning and prepping surfaces.

Block Size	Block	Number of Rows	Wire Size	Trim Length	Standard Pack	Item Number
<b>Stainless Steel Wire</b>						
7-1/2" x 1/2"	Plastic	3 x 7	.006	1/2"	36	44075 ■
7-1/2" x 1/2"	Wood	3 x 7	.006	1/2"	36	44167 ■ +
7-3/4" x 3/8"	Wood	3 x 7	.006	1/2"	36	44551 *
8-3/4" x 1/2"	Wood	2 x 9	.006	5/8"	36	95013
<b>Straight Brass Wire</b>						
7-1/2" x 1/2"	Wood	3 x 7	.006	1/2"	36	44189 ■
<b>Crimped Brass Wire</b>						
6" x 1/2"	Wood	3 x 10	.005	5/8"	72	44619
8-3/4" x 1/2"	Wood	2 x 9	.008	5/8"	36	95014
<b>Crimped Aluminum</b>						
6-3/4" x 1-5/8"	Wood	6 x 9	.008	5/8"	12	95151
8-3/4" x 1/2"	Wood	2 x 9	.008	5/8"	36	44251
<b>Straight Black Nylon</b>						
6-1/2" x 1/2"	Plastic	4 x 15	.010	1/2"	24	99383
7-1/2" x 1/2"	Wood	3 x 7	.012	1/2"	36	44637 ■
<b>White Nylon</b>						
7-1/2" x 1/2"	Plastic	3 x 7	.016	1/2"	36	44609
<b>Double-Sided Brass/White Nylon</b>						
7-1/2" x 1/2"	Plastic	3 x 7	.006/.016	1/2"	24	44731
<b>Double-Sided Brass/Stainless Steel</b>						
7-1/2" x 1/2"	Plastic	3 x 7	.006/.006	1/2"	24	44732
<b>Double-Sided Stainless Steel/White Nylon</b>						
7-1/2" x 1/2"	Plastic	3 x 7	.006/.016	1/2"	24	44733

+Countertop display available. See page 133 for details. ■ Packaged product available. See pages 123-133 for details.

\*Wire drawn

Key:

**P** Performance line  
Industrial Grade

**V** Value line  
Professional Grade

**V** **VORTEC PRO® SMALL HAND SCRATCH BRUSHES** - Reliable and efficient brushes at a value price.

Block Size	Handle	Number of Rows	Trim Length	Standard Pack	Item Number
<b>.006 Stainless Steel Wire</b>					
7-1/2" x 1/2"	Wood	3 x 7	1/2"	36	44805
7-1/2" x 1/2"	Plastic	3 x 7	1/2"	36	44806
<b>.006 Straight Brass Wire</b>					
7-1/2" x 1/2"	Wood	3 x 7	1/2"	36	44810



44806

**P** **BLOCK TYPE SCRATCH BRUSHES** - For rugged cleaning on bricks, stone and similar large flat areas.

Block Size	Fill Material	Brush Part	Number of Rows	Trim Length	Standard Pack	Item Number
7-1/4" x 2-5/8"	.012 Round Wire - Curved Face	7"	9 x 21	1-3/16"	12	44066
7-1/4" x 2-1/4"	.014 Round Wire - Flat Face	7"	6 x 19	1-5/8"	12	44067



44067

**V** **VORTEC PRO BLOCK TYPE SCRATCH BRUSH** - Reliable and efficient brushes at a value price.

Block Size	Fill Material	Brush Part	Number of Rows	Trim Length	Standard Pack	Item Number
7-1/4" x 2-1/4"	.012 Steel	7"	6 x 19	1-5/8"	12	25212

**P** **BUTCHER BLOCK BRUSH** - For cleaning concrete forms and green concrete after forms have been removed.

Block Size	Fill Material	Brush Part	Number of Rows	Trim Length	Standard Pack	Item Number
7-1/2" x 2-3/4"	.017 x .110 - Flat Wire	7"	5 x 10	1-1/4"	12	44073



44073

**P** **CHIPPING HAMMER REFILL** - A refill brush for most chipping hammers. Used for weld cleaning.

Block Size	Fill Material	Brush Part	Number of Rows	Trim Length	Standard Pack	Item Number
4-5/8" x 7/8"	.012 Steel	4-1/2"	3 x 15	1-1/8"	12	44070



44070

**P** **WIRE DUSTER** - For cleaning chips, borings, solder, rust, dirt & corrosion from castings.

Block Size	Fill Material	Handle Length	Number of Rows	Trim Length	Standard Pack	Item Number
3" x 1-1/8"	.012 Steel	5-3/4"	4 x 8	2-1/2"	12	44451



44451

**P** **FILE CARD BRUSH** - Waxed hardwood block. Use for file cleaning or to roughen and prepare surface material prior to sweating and soldering.

Overall Length	Fill Material	Brush Part	Trim Length	Standard Pack	Item Number
8-1/4"	.012 Steel	1-5/8" x 4"	1/4"	12	44260



44260

**P** **METAL CHIP BRUSH** - Small stiff wire brush for brushing hot metal. Can be exposed to flames without burning.

Overall Length	Fill Material	Trim Length	Face Width	Standard Pack	Item Number
5-1/2"	.012 Steel	1-1/2"	1-1/4"	12	44074



44074

# FLUE BRUSHES



Cleaning boiler pipes with a flue brush.

Flue Brushes are designed and engineered from black oil-tempered wire. Flue brushes are available in single spiral and double spiral construction. Other fill materials and sizes available by special order. Contact Customer Service for details.

## APPLICATIONS

Provides increased conformability and long life when:

- Pipe cleaning
- Flue cleaning
- Boiler tube cleaning

**P**

**FLUE BRUSHES** - Filled with .012 round wire and fitted with 1/4" x 2" NPT pipe nipple.

For internal cleaning of pipes and flues.



44131

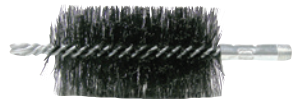

44154

Brush Diameter	Brush Length	Overall Length	Standard Pack	Item Number
<b>Single Spiral</b>				
7/8"	4-1/2"	7-1/2"	1	44124
1"	4-1/2"	7-1/2"	1	44125
1-1/4"	4-1/2"	7-1/2"	1	44047
1-1/2"	4-1/2"	7-1/2"	1	44128
1-3/4"	4-1/2"	7-1/2"	1	44048
2"	4-1/2"	7-1/2"	1	44131
2-1/2"	4-1/2"	7-1/2"	1	44133
3"	4-1/2"	7-1/2"	1	44135
3-1/2"	4-1/2"	7-1/2"	1	44137
4"	4-1/2"	7-1/2"	1	44139
<b>Double Spiral</b>				
1"	4-1/2"	7-1/2"	1	44149
1-1/4"	4-1/2"	7-1/2"	1	44035
1-1/2"	4-1/2"	7-1/2"	1	44150
1-3/4"	4-1/2"	7-1/2"	1	44036
2"	4-1/2"	7-1/2"	1	44152
2-1/4"	4-1/2"	7-1/2"	1	44037
2-1/2"	4-1/2"	7-1/2"	1	44154
2-3/4"	4-1/2"	7-1/2"	1	44038
3"	4-1/2"	7-1/2"	1	44156
4"	4-1/2"	7-1/2"	1	44169
4-7/8"	4-1/2"	7-1/2"	1	44159



95925

**P**

**FLUE BRUSH EXTENSION ROD** - One 1/4" male pipe nipple and one 1/4" female pipe coupling allows user to extend flue brush.

Description	Standard Pack	Item Number
36" Fiberglass Extension Rod	1	95925

## NOTE

"Pipeline" Flue Brushes By Special Order Only.

- Heavy-duty. Exact size diameter. Rugged double stem, single spiral.
- Fitted with 1/4" pipe nipple. Available in diameters of 1-5/8" - 15".

Key:

**P** Performance line  
Industrial Grade

**V** Value line  
Professional Grade



# TUBE FITTING BRUSHES

Several configurations and sizes of Tube Fitting Brushes are available for cleaning and deburring copper, internal and external tube fittings. The handy 4-in-1 tube fitting brush cleans both outside and inside diameters of multiple tube sizes.



Cleaning the inside of a copper fitting prior to soldering.

**P INTERNAL TUBE FITTING BRUSHES - Wire Fill** - For internal cleaning and deburring of copper tube fittings. Also used in trucking and marine industries as a light socket cleaning brush.

Pipe Size	Actual Brush Diameter	Brush Length	Overall Length	Handle Length	Standard Pack	Item Number
1/8"	1/4"	1"	6-1/2"	3-1/4"	12	44078
1/4"	3/8"	1"	6-1/2"	3-1/4"	12	44079
3/8"	1/2"	1"	6-1/2"	3-1/4"	12	44080 ■
1/2"	5/8"	1"	6-1/2"	3-1/4"	12	44081
5/8"	3/4"	1"	6-1/2"	3-1/4"	12	44082
3/4"	7/8"	1"	6-1/2"	3-1/4"	12	44083
7/8"	1"	1"	6-1/2"	3-1/4"	12	44084
1"	1-1/8"	1"	6-1/2"	3-1/4"	12	44085
1-1/4"	1-3/8"	1"	6-1/2"	3-1/4"	12	44086
1-1/2"	1-5/8"	1-1/2"	6-1/2"	3-1/4"	6	44087

■ Packaged product available. See pages 131-141 for details.

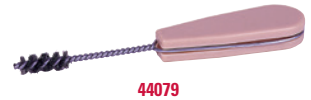

44079

**P EXTERNAL TUBE FITTING BRUSHES - 1/4" Stem**

Ideal for cleaning tube ends. Mount to a hand drill for fast results.

Outside Diameter	Standard Pack	Item Number
3/8"	40	44734
1/2"	40	44735
5/8"	40	44736
3/4"	40	44737
7/8"	40	44738
1"	40	44739



44734

**P 4-IN-1 TUBE FITTING BRUSH - ONE BRUSH REPLACES FOUR! - Steel Wire**

Cleans the outside and inside diameters of 1/2" and 3/4" tubes and fittings. Use for soldering prep, deburring, drill hole cleaning and cleaning battery terminals.

Tube Inside Diameter	Tube Outside Diameter	Standard Pack	Item Number
3/4" and 1/2"	7/8" and 5/8"	1	44690



44690

**TURBO TUBE™ BRUSHING TOOL** - The Turbo Tube Brushing Tool is two brushes in one, so fittings and copper tubing can be easily cleaned without changing tools!

## APPLICATIONS

- Fitting brush cleans outside diameter
- Tube brush cleans inside diameter
- Ideal for plumbing and HVAC projects

**V VORTEC PRO® TURBO TUBE BRUSHES** - Clean I.D. and O.D. with the same tool. Rust-proof stainless steel bristles. Reliable and efficient brushes at a value price.

I.D. Size	O.D. Size	Wire Type	Max. RPM	Standard Pack	Item Number
1/2"	5/8"	Stainless	1,000	1	36303
3/4"	7/8"				36304
1"	1-1/8"				36305



36303

COATED ABRASIVES

NON-WOVEN ABRASIVES

POWER BRUSHES

NYLON BRUSHES

PACKAGED ITEMS

MAINTENANCE

# SELECTING THE RIGHT BRUSH

## **P** PERFORMANCE LINE (INDUSTRIAL GRADE)

Engineered and manufactured to maximize performance and minimize operating costs. The use of superior construction, the highest quality materials and the most stringent manufacturing processes deliver the lowest cost-of-use and most consistent performance.

## **V** VALUE LINE (PROFESSIONAL GRADE)

Weiler's value line is manufactured using similar product construction and the same exacting standards as other Weiler paint & varnish products, but engineered to provide cost-effective use specifically designed for the professional, providing a cost-effective price. Vortec Pro® paint & varnish products are an economical choice for the construction trades, low volume production shops and light-duty industrial MRO use.

## SELECTION GUIDE

Brush Fill	Recommended For	Benefits
China Bristle	All oil based and alkyd paints, stains, varnish urethane & shellac	<ul style="list-style-type: none"> <li>• Softest tip for fewest brush marks</li> <li>• Natural fibers hold paint better than synthetics</li> </ul>
Polyester/Nylon blend	All paints and coatings	<ul style="list-style-type: none"> <li>• Most durable material</li> <li>• Precise tipping</li> <li>• Cleans up easily</li> </ul>
Polyester	All paints and coatings	<ul style="list-style-type: none"> <li>• Low cost</li> <li>• Does not absorb water</li> </ul>

## PAINT BRUSH FEATURES

### Fill Material:

- Natural China Bristle or Tapered Polyester
- Various sizes of fill material are blended together to create the proper taper.

### Flagged Ends:

A split at the end of each tapered fiber of fill material. Bristle is naturally tapered with a flagged tip. Polyester fibers are made tapered and then mechanically processed to form a flagged tip. Flagging allows each tip to pick up more paint and spread it more evenly.

**Thickness:** The thickness of the brush, measured at the ferrule, will determine the quality level of the brush. The thicker the brush, the more paint pick-up and release.

**Ferrule:** The metal band that holds the fill material and handle together. All Weiler paint and varnish brushes are made with plated metal ferrules that will not rust or corrode.

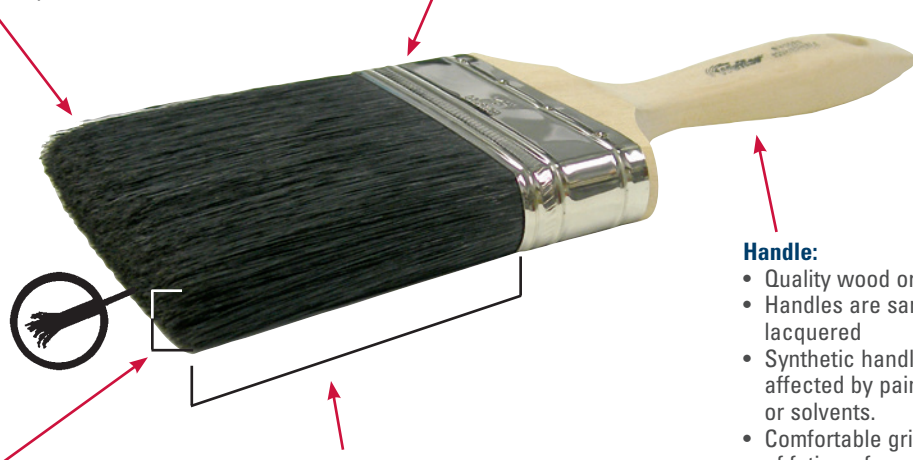

**Trim Length:** The length of the fill material extending from the ferrule. The longer the trim, the more paint is picked up and released for a quicker, easier job.

### Handle:

- Quality wood or synthetic
- Handles are sanded and lacquered
- Synthetic handles are not affected by paints, varnishes or solvents.
- Comfortable grip for hours of fatigue-free use.

## PAINT BRUSH CARE

Brushes Used In	Clean With
<ul style="list-style-type: none"> <li>• Oil base paint</li> <li>• Latex paint</li> <li>• Water base paint</li> <li>• Varnish</li> <li>• Shellac</li> </ul>	<ul style="list-style-type: none"> <li>• Turpentine or mineral spirits</li> <li>• Warm soapy water</li> <li>• Warm soapy water</li> <li>• Turpentine or mineral spirits</li> <li>• Alcohol</li> </ul>

Note: After cleaning, shake out, comb bristles and hang by handle.

## SPECIAL PAINT BRUSHES

The brushes listed in this catalog will cover the major requirements of industry. However, if an application requires another type, size or style of brush, contact your nearest Weiler distributor or Weiler's Customer Experience Team.

# PROFESSIONAL PAINT, VARNISH & SASH BRUSHES

These high quality brushes are available in a wide variety of sizes and materials to fill all applications. The Professional Wall Brushes have a sanded wooden handle, the preferred standard among professional users. The Professional Varnish and Sash Brushes are color coded - Blue for Bristle and Red for Polyester/Nylon Blend, and feature painted foam handles in the "beaver tail" style. These handles are attractive and easier to grip, reducing user fatigue.



Applying paint to clap board siding.

## **P** WALL PAINT BRUSHES - For interior/exterior painting of large flat surfaces.

Width	Thickness	Bristle Length	Overall Length	Standard Pack	Item Number
<b>Black China Bristle - Sanded Wood Handle</b>					
3"	7/8"	3-1/4"	10-3/16"	6	40022
4"	7/8"	3-3/4"	11-1/2"	6	40023
<b>Poly/Nylon - Sanded Wood Handle</b>					
3"	7/8"	3"	10-1/8"	6	40061
4"	7/8"	3"	11-1/4"	6	40062



40022



40061

## **P** VARNISH BRUSHES - Comfortable foam grip handle; smooth paint flow.

Width	Thickness	Bristle Length	Overall Length	Standard Pack	Item Number
<b>Black China Bristle - Blue Foam Handle</b>					
1"	7/16"	2"	8-1/2"	12	40000
1-1/2"	1/2"	2-1/4"	8-7/8"	12	40001
2"	9/16"	3"	9-3/4"	12	40002
3"	11/16"	3"	10-1/8"	12	40004
4"	11/16"	3"	10-9/16"	12	40010
<b>Poly/Nylon - Red Foam Handle</b>					
1"	7/16"	2-1/4"	8-13/16"	12	40058
2"	3/4"	2-3/4"	9-15/16"	12	40059
3"	7/8"	3"	10-1/8"	12	40060
4"	7/8"	3"	11"	6	40106



40002



40059

## **P** ANGLED SASH BRUSHES - For trim or cut work like window sills, door frames, etc.

Width	Thickness	Bristle Length	Overall Length	Standard Pack	Item Number
<b>Black China Bristle - Blue Foam Handle</b>					
1-1/2"	7/16"	2-1/4"	10-7/8"	12	40041
2"	1/2"	2-1/4"	10-3/4"	12	40008
<b>Poly/Nylon - Red Foam Handle</b>					
1-1/2"	7/16"	2-1/2"	11-1/4"	12	40011
2"	1/2"	2-1/2"	11-1/8"	12	40040



40041



40040

## **P** FLAT SASH BRUSHES - For trim or cut work like window sills, door frames, or other narrow, flat surfaces.

Width	Thickness	Bristle Length	Overall Length	Standard Pack	Item Number
<b>Black China Bristle - Blue Foam Handle</b>					
1"	3/8"	2"	10-3/8"	12	40113
1-1/2"	7/16"	2-1/4"	10-1/2"	12	40114
2"	9/16"	3"	11-15/16"	12	40115
<b>Poly/Nylon - Red Foam Handle</b>					
1"	3/8"	2-1/4"	10-1/4"	12	40014
1-1/2"	7/16"	2-1/4"	10-1/2"	12	40017
2"	9/16"	2-1/2"	10-15/16"	12	40018



40115



40017

COATED ABRASIVES

NON-WOVEN ABRASIVES

POWER BRUSHES

NYLON BRUSHES

PACKAGED ITEMS

MAINTENANCE



# PROFESSIONAL SASH & PARTS CLEANING BRUSHES

These high quality brushes are available in a wide variety of sizes and materials to fill all applications. The Professional Sash Brushes are color coded - Blue for Bristle and Red for Polyester/Nylon Blend, and feature painted foam handles in the "beaver tail" style. These handles are attractive and easier to grip, reducing user fatigue. Parts cleaning brushes are ideal for applications such as cleaning carburetors, transmission components, applying adhesives and lubricants.

Cleaning an oil pan with a parts cleaning brush.

## **P** OVAL SASH BRUSHES - Ideal for cleaning parts, crevices and painting hard-to-reach areas.



40056

Size	Thickness	Bristle Length	Overall Length	Standard Pack	Item Number
<b>Black China Bristle - Plain Foam Handle - Chisel Trim</b>					
#2	7/16"	1-3/4"	8-7/8"	24	40116
#4	11/16"	1-3/4"	8-5/8"	12	40019
#6	13/16"	1-3/4"	9-5/16"	12	40056
#8	15/16"	3"	11-1/8"	12	40020
#10	1-1/16"	3"	11-3/16"	12	40021

## **P** ROUND SASH BRUSHES - Ideal for cleaning parts, crevices and painting hard-to-reach areas.



40121

Size	Thickness	Bristle Length	Overall Length	Standard Pack	Item Number
<b>Grey Bristle - Plain Foam Handle - Flat Trim</b>					
#2	7/16"	1-3/4"	8-3/4"	24	40118
#4	11/16"	2"	8-13/16"	12	40119
#6	13/16"	2"	10-1/16"	12	40120
#8	15/16"	2-1/4"	10-9/16"	12	40121
#10	1-1/16"	2-1/4"	10-9/16"	12	40122

## **P** PARTS CLEANING BRUSHES - Stainless steel ferrule - Heavily filled.



40035

Thickness	Fill Material	Bristle Length	Overall Length	Standard Pack	Item Number
<b>Plain Foam Handle - Chisel Trim</b>					
1"	Synthetic	2-1/2"	10-11/16"	12	40035
1"	Tampico	2-3/4"	11-1/8"	12	40036

## **V** VORTEC PRO® PARTS CLEANING BRUSHES - Reliable and efficient brushes at a value price.



25222

Thickness	Fill Material	Bristle Length	Overall Length	Standard Pack	Item Number
<b>Plain Foam Handle - Chisel Trim</b>					
15/16"	Nylon	2-1/2"	11-3/16"	12	25221
1"	Tampico	2-3/4"	11-3/8"	12	25222

# INDUSTRIAL PAINT BRUSHES

The Industrial paint brush line features color coded plastic handles to provide quality paint brushes at competitive prices.

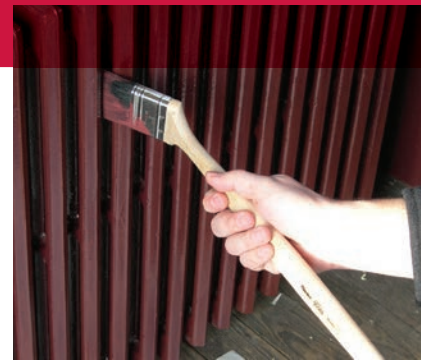

Painting inside the fins of a radiator with a Radiator brush.

## **P** INDUSTRIAL VARNISH BRUSHES - Heavily-filled brush with comfortable handle in a variety of sizes.

Width	Thickness	Bristle Length	Overall Length	Standard Pack	Item Number
<b>Black Bristle - Black Plastic Handle</b>					
1"	3/8"	1-3/4"	7-3/4"	36	40089
1-1/2"	7/16"	2"	8-5/16"	24	40101
2"	7/16"	1-3/4"	8"	12	40074
3"	1/2"	2"	8-13/16"	12	40103
4"	5/8"	2-3/4"	9-7/8"	12	40104
<b>Black Polyester - Red Plastic Handle</b>					
1"	3/8"	2"	8"	36	40107
1-1/2"	7/16"	2"	7-11/16"	24	40108
2"	7/16"	2"	8-1/2"	12	40109
3"	1/2"	2"	9-1/4"	12	40110
4"	11/16"	2-3/4"	9-7/8"	12	40111



40074



40109

## **P** BENT RADIATOR BRUSH - Ideal for painting radiators and other hard-to-reach areas.

Width	Thickness	Bristle Length	Overall Length	Standard Pack	Item Number
<b>Black Bristle - Wood Handle</b>					
2"	9/16"	2-1/4"	19-1/2"	12	95502



95502

## **V** VORTEC PRO® FOAM APPLICATOR BRUSHES - Reliable and efficient brushes at a value price.

Not recommended for use with lacquer, shellac or solvents.

Width	Thickness	Foam Length	Overall Length	Standard Pack	Item Number
<b>Wood Handle</b>					
1"	5/8"	2-5/8"	6-3/8"	50	99801
2"	5/8"	2-5/8"	6-1/2"	50	99805
3"	7/16"	2-5/8"	6-1/2"	40	99806

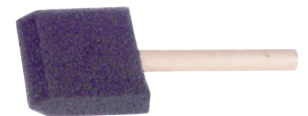

99806

Key:

**P** Performance line  
Industrial Grade

**V** Value line  
Professional Grade

COATED ABRASIVES

NON-WOVEN ABRASIVES

POWER BRUSHES

NYLON BRUSHES

PACKAGED ITEMS

MAINTENANCE

# CHIP AND OIL BRUSHES



Removing chips from the ways of a lathe.

Chip and Oil brushes are inexpensive, multi-purpose brushes for use in applications requiring disposable brushes.

## **P** CHIP AND OIL BRUSHES

Width	Thickness	Bristle Length	Overall Length	Standard Pack	Item Number
<b>White Bristle - Wood Handle</b>					
1/2"	5/16"	1-1/2"	7-3/16"	30	40065
1"	5/16"	1-1/2"	7"	30	40066
1-1/2"	5/16"	1-1/2"	7-7/8"	30	40067
2"	5/16"	1-1/2"	7-5/8"	20	40068
2-1/2"	3/8"	1-1/2"	7-3/4"	20	40069
3"	3/8"	1-1/2"	7-7/8"	10	40070
4"	5/8"	1-5/8"	8-9/16"	10	40071
	3/8"	2"	8-7/8"		40076



40068

## **V** VORTEC PRO® CHIP AND OIL BRUSHES - Reliable and efficient brushes at a value price.

Width	Thickness	Bristle Length	Overall Length	Standard Pack	Item Number
<b>White Bristle - Wood Handle</b>					
1/2"	5/16"	1-1/2"	7-3/16"	36	40177
1"	5/16"	1-1/2"	7-3/16"	36	40179
1-1/2"	5/16"	1-1/2"	7-1/16"	24	40180
2"	5/16"	1-1/2"	7-5/8"	24	40181
2-1/2"	3/8"	1-1/2"	7-15/16"	12	40182
3"	3/8"	1-1/2"	8-1/4"	12	40183
4"	5/8"	1-3/4"	8-3/4"	12	40184
4"	3/8"	1-3/4"	8-1/2"	12	40185
<b>Black Bristle - Plastic Handle</b>					
1/2"	1/4"	1-5/8"	7-1/8"	30	40160
1"	5/16"	1-5/8"	7-5/16"	30	40161
1-1/2"	5/16"	1-5/8"	7-3/8"	30	40162
2"	5/16"	1-5/8"	7-3/4"	20	40163
2-1/2"	3/8"	1-3/4"	7-3/4"	20	40164
3"	3/8"	1-3/4"	7-15/16"	10	40165
4"	11/16"	2"	8-1/2"	10	40166
<b>Grey China Bristle - Plastic Handle</b>					
1/2"	1/4"	1-1/2"	7-1/8"	48	40026
1"	5/16"	1-1/2"	7-5/8"	36	40027
1-1/2"	5/16"	1-1/2"	7-5/8"	24	40028
2"	3/8"	1-1/2"	7-7/8"	24	40029
2-1/2"	1/2"	1-1/2"	8-5/16"	12	40030
3"	1/2"	1-1/2"	8-9/16"	12	40031
4"	11/16"	1-1/2"	8-13/16"	12	40032
<b>Black Synthetic - Red Plastic Handle</b>					
1"	5/16"	1-3/4"	7-9/16"	36	40137
2"	3/8"	1-3/4"	7-15/16"	24	40139
3"	1/2"	1-3/4"	9-3/16"	12	40140
4"	11/16"	2-3/4"	9-5/8"	12	40141



40181



40161



40029



40141

Key:

**P** Performance line  
Industrial Grade

**V** Value line  
Professional Grade



# MARKING BRUSHES

Weiler's high quality Marking Brushes come in a variety of animal, natural and synthetic bristles in numerous handle styles for many applications such as fine artwork, pin striping and sign painting.



Painting a tight area on a steel door with a Marking Brush.

## **P** RED SABLE WATERCOLOR BRUSHES - Seamless ferrule. Pointed tip - Round black handle

Size	Diameter	Trim Length	Overall Length	Standard Pack	Item Number
3/0	3/64"	1/4"	7"	12	41000
0	1/16"	5/16"	7-1/4"	12	41001
2	3/32"	7/16"	7-3/8"	12	41002
4	1/8"	5/8"	7-5/8"	12	41003



41003

## **P** BLACK BRISTLE MARKING BRUSHES - Long, lacquered handle

Size	Diameter	Trim Length	Overall Length	Standard Pack	Item Number
1	1/8"	3/4"	11-7/8"	12	41004
2	5/32"	15/16"	12"	12	41005
4	7/32"	1-1/8"	12-1/2"	12	41007
5	1/4"	1-1/4"	12-1/2"	12	41008
6	9/32"	1-3/8"	12-3/4"	12	41009



41009

## **P** FLAT MARKING BRUSHES - Ox hair - Single stroke - Round black handle

Width	Trim Length	Overall Length	Standard Pack	Item Number
1/4"	7/8"	7-7/8"	12	41018
1/2"	1"	8-3/4"	12	41019
3/4"	1-1/4"	8-3/4"	12	41020
1"	1-3/8"	9-3/8"	12	41021



41021

## **P** FITCH BRUSHES - Black china bristle - Chiseled edge - Clear lacquered handle

Width	Trim Length	Overall Length	Standard Pack	Item Number
1/4"	13/16"	12"	12	41022
1/2"	1-1/16"	12-3/8"	12	41023
3/4"	1-5/16"	12-7/8"	12	41024
1"	1-9/16"	13"	12	41025



41024

## **P** LACQUERING BRUSHES - Seamless aluminum ferrule - Camel hair - Round black handle

Size	Diameter	Trim Length	Overall Length	Standard Pack	Item Number
1	5/32"	11/16"	7-1/2"	12	41010
3	7/32"	13/16"	8"	12	41011
5	1/4"	1-1/8"	8-3/4"	12	41012
6	5/16"	1-3/16"	8-7/8"	12	41013



41011

COATED ABRASIVES

NON-WOVEN ABRASIVES

POWER BRUSHES

NYLON BRUSHES

PACKAGED ITEMS

MAINTENANCE

# GLUE AND ACID BRUSHES

Weiler's Glue and Acid Brushes come in multiple sizes, ferrule types, handles and fill materials for a wide variety of cleaning and coating applications.



Applying flux to a copper tube prior to soldering.



40078

## **P** BRIDLED GLUE BRUSHES - Grey china bristle - Steel ferrule - Long foam handle

Diameter	Trim Length	Overall Length	Standard Pack	Item Number
7/16"	1-7/16"	8-1/4"	36	40077
13/16"	1-3/4"	9-3/8"	24	40078



44089

## **P** ACID/FLUX BRUSHES - Horsehair - Tin ferrule

Width	Trim Length	Overall Length	Standard Pack	Item Number
5/16"	3/4"	5-3/4"	144	44088 ■
3/8"	3/4"	5-3/4"	144	44089 ■
1/2"	3/4"	5-3/4"	144	44090 ■

■ Packaged product available. See pages 131-141 for details.



44097

## **P** STYLUS BRUSH - Stiff grey horsehair - Aluminum tube with cork to hold cleaning fluid. For cleaning electrical contact points.

Width	Trim Length	Overall Length	Standard Pack	Item Number
1/2"	3/8"	5"	100	44097



40082

## **P** STENCIL BRUSHES - China bristle - Seamless steel ferrule - Lacquered wood handle

Diameter	Bristle Length	Overall Length	Standard Pack	Item Number
1"	1-3/8"	5-1/2"	12	40080
2"	1-3/4"	6-3/8"	12	40082



44262

## **P** DOPE BRUSHES - With hanger for coating applications in drilling operations.

Brush Part	Fill Material	Diameter	Overall Length	Standard Pack	Item Number
4"	Mixed	2"	16"	24	44261
	Tampico	2-1/2"		24	44262
		3"		6	44263

Key:

**P** Performance line  
Industrial Grade

**V** Value line  
Professional Grade

# PAINT ROLLERS AND ACCESSORIES

Paint Rollers can be used almost anywhere including walls, ceilings, floors, decks, fences, metal surfaces, concrete, and brick walls. Weiler carries a wide variety of rollers for the professional painter, industrial use and those weekend DIY projects.

## PAINT ROLLER SELECTION GUIDE

Work Surface	Coating	Recommended Nap
Metal, Smooth Wood, Smooth Concrete	Enamels, Epoxies, Adhesives, Paint	3/16", 3/8" (Low nap)
Rough Wood, Drywall, Cement Block	All Paint	1/2", 3/4" (Medium nap)
Stucco, Brick, Concrete	All Paint	1" (High nap)



Applying primer to new drywall.

### P PROFESSIONAL GRADE ROLLERS - Poly blend with phenolic core.

Size	Nap	Painting Surface	Standard Pack	Item Number
9"	3/16"	Smooth	12	49050
	1/2"	Semi-smooth		49051
	3/4"	Rough		49052



49050

### P INDUSTRIAL GRADE ROLLERS - Poly blend with PVC core.

Size	Nap	Painting Surface	Standard Pack	Item Number
3"	3/8"	Semi-smooth	24	49046
4"	3/8"	Semi-smooth	12	49044
	3/4"	Rough		49045
9"	3/16"	Smooth	12	49061
	1/2"	Semi-smooth		49062
	3/4"	Rough		49063
	1"	Extra Rough		49053



49045



49063

### V VORTEC PRO® ROLLERS - Poly blend with PVC core. Reliable and efficient rollers at a value price.

Size	Nap	Painting Surface	Standard Pack	Item Number
9"	3/8"	Semi-smooth	12	49070
	1/2"	Semi-smooth		49071



49070

### P SPECIALTY ROLLERS - Can be used with all paints. Ideal for trim and touch-up.

Description	Overall Length	Std. Pack	Item No.
3" Roller with 3/8" nap. Standard duty frame	11-1/2"	24	49016
3" Roller with 3/8" nap. Wire frame with two tin end caps. Bent wire handle.	6-1/8"	12	49015
4" Micro Perlon Roller Reach	16-3/8"	24	49025
4" Micro Perlon Twin Pack Cover	4-1/8"	24	49066



49015

49025

### P FRAMES - All metal with two plastic caps. Solid plastic handle with threaded grip. Can be used with threaded handle #44300 on page 152.

Size	Description	Overall Length	Standard Pack	Item Number
3"	Standard-duty 1/4" dia. frame with 4 wire cage	11-3/8"	24	49019
4"	Standard-duty 1/4" dia. frame with 4 wire cage	11-3/4"	24	49018
9"	Heavy-duty 5/16" dia. frame with 5 wire cage	13-1/2"	12	49022



49018

### V VORTEC PRO FRAME - Reliable and efficient frame at a value price.

Size	Description	Overall Length	Standard Pack	Item Number
9"	Standard-duty 1/4" dia. frame with 4 wire cage	12-3/4"	24	49020

### P PAINT TRAYS - A variety of trays available to meet users' specific needs.

Description	Paint Capacity	Standard Pack	Item Number
4" Plastic tray	1 Quart	24	49008
9" Galvanized steel tray; Rust resistant	2 Quart	24	49010
9" Paint tray liner	2 Quart	24	96702



49010

### V VORTEC PRO PAINT TRAY - Reliable and efficient tray at a value price.

Description	Paint Capacity	Standard Pack	Item Number
9" Economy plastic tray; Rust proof	2 Quart	20	49011



49011

COATED ABRASIVES

NON-WOVEN ABRASIVES

POWER BRUSHES

NYLON BRUSHES

PACKAGED ITEMS

MAINTENANCE



# ALPHABETICAL INDEX

Description	Page	Description	Page	Description	Page
4-in-1 Tube Fitting Brushes	169	Combo Wheels	20-21	Flux Brushes	176
<b>A</b>		Concave Brushes	77	FME Area Products	130
Abrasive Flap Disc Technical Information	24-27	Conflex Brushes	76-77, 130, 132, 139	<b>G</b>	
Abrasive Flap Discs	28-41, 135	Contractor Brooms	148	Garage Brushes	151
Tiger® X	28-29	Controlled Flare End Brushes	84	Glue Brushes	176
Tiger	30-31	Counter Dusters	155	Green Works™ Maintenance Products	146
Big Cat®	32, 135	Crack Cleaning Brushes	65	Grinding Wheels	18-19, 21
Tiger Trim	33, 135	Crimped Wire Wheels	70-77, 138	Grout Detail Brush	159
Tiger Angled	34-35	Crosshole Deburring Brushes	86, 118	Gun Cleaning Brushes	90
Saber Tooth™	36, 135	Cup Brushes		<b>H</b>	
BobCat®	37	Crimped Wire	81, 133, 139	Hand Pads	51
Tiger Paw™	38-39, 135	Crimped Wire-Non-Sparking	95	Hand Scrub Brushes	158-159
Wolverine™	40-41, 135	Knot Wire	79-80, 133, 139	Handles	152-153
Abrasives	9-52	Miniature	92	<b>I</b>	
Abrasive Nylon Filament Brushes (Nylox)	115-127	Nylon Abrasive Filament (Nylox)	117	Industrial Paint Brushes	173
Acid Brushes	134, 164, 176	Stem-Mounted	81, 133	Interleaf Flap Wheels	51
Adapters		Cutting Wheels	14-17	Internal Tube Fitting Brushes	134, 169
Adapters, Small Angle Grinder Brushes	67, 139	<b>D</b>		<b>J</b>	
Metal	47, 72, 78, 128	Deck Scrub Brushes	158	Joint/Crack Cleaning Brushes	65
Plastic Adapters	65, 75, 115, 129	Deck Mops	161	<b>K</b>	
Pressboard Adapters	128	Diamond Filament Wheels	127	Knot Wire	
Threaded	67, 139	Disc Brushes	120-122	Wheels	63-69, 132, 138
TRIM-KUT Adapters	45	Display Packaged Product	136-141	Cup Brushes	79-81, 133, 139
Adapting Nuts	17, 31, 45	Dope Brushes	176	End Brushes	82-85, 133, 140
AL-tra CUT™ Discs	43	Drive Arbors	45-46, 75, 88, 115, 118, 129	<b>L</b>	
Angled Flap Discs	34-35	Driveway Coaters	150	Lacquering Brushes	175
Arbor Hole Table	57	Dually® Weld Cleaning Brushes	69	Lubricant (Lubricut)	128
Artist Brushes	175	Dust Mops	162	<b>M</b>	
Acid Scrub Brushes	164	Dust Pans	155	Maintenance Products	142-177
Application Engineering Information	113	Dusting Brushes	162	Maintenance Technical Information	144-145, 170
Applicator Brushes	163-164	<b>E</b>		Mandrels	17, 37, 45, 50
<b>B</b>		Encapsulated Brushes (Polyflex)		Marking Brushes	175
Back-up Pads	37, 43-44, 52	Stem-Mounted Wheels (Conflex)	76	Masonry Brushes	163-164
Bamboo Handles	146	Crimped Wire Wheels	71, 73	Metal Adapters	47, 72, 78, 128
Bent Radiator Brush	173	Cup Brushes	80	Metal Chip Brush	167
Bevel Brushes, Knot Wire	67	End Brushes	84	Mini Disc Brushes	122
Big Cat® Hlgh Density Flap Discs	32, 135	Flared End Brushes	85	Miniature Brushes	
Bi-Level Scrubs	158	Knot Wire Wheels	68	Cup	92
Blending Discs	43-44	Small Diameter Wire Wheels	75	End	93
Bob Cat™ Mini Flap Discs	37	Tube Brushes	88	End (Nylox)	93, 116, 123
Bob Cat Drive Mandrel	37	End Brushes		Wheel	92
Bonded Abrasives	9-21	Circular Flared	85, 133	Mop Handles	161-162
Bonded Abrasive Technical Information	10-13	Controlled Flare	84	Mops	161-162
Bore-Rx™ Brushes	86, 118	Crimped Wire	83-85, 133, 140	<b>N</b>	
Bottle Washing Brush	160	Encapsulated	84-85	Nail Brushes	160
Bowl Brushes	159-160	Knot Wire	82, 133, 140	New Products	6
Braces and Tips	153	Miniature	93	Non-Sparking Brushes	94-95
Brooms	146-151, 154	Non-Sparking	95	Non-Woven Abrasives	49-52
Burr-Rx® Brushes	115-126	Nylon Abrasive Filament (Nylox)	116, 123	Non-Woven Unitized Wheels	50
Butcher Block Brushes	167	Pencil	85	Non-Woven Flap Wheels	51
Bus Brush	157	Pilot Bonding	84	Non-Woven Hand Pads	51
<b>C</b>		Engineered Product (Nylox)	113	Non-Woven Surface Conditioning Discs	52
Cement Finishing Brushes	164	External Tube Fitting Brushes	169	Nylon Abrasive Filament Brushes (Nylox)	102-130
Chip & Oil Brushes	174	<b>F</b>		Adapters & Drive Arbors	128-129
Chipping Hammer Refill	167	File Card Brush	167	Bore-Rx	118
Circular Flared End Brushes	85, 133	Fitch Brushes	175	<b>N</b>	
Coated Abrasives	22-48	Flap Wheels	46-47, 51	Nail Brushes	160
Coated Abrasives Technical Information	24-27	Floor Brushes	146-151	New Products	6
Combo Bucket	161	Floor Squeegees	156	Non-Sparking Brushes	94-95
		Flue Brushes	168	Non-Woven Abrasives	49-52

# ALPHABETICAL INDEX

Description	Page	Description	Page	Description	Page
Burr-Rx	115-126	Shop Rolls	48	Turbo Tube Brushing Tool	169
Cup Brushes	117	Small Diameter Wire Brushes	74-75, 115	<b>U</b>	
Disc Brushes	120-122	Smoothing Brush	164	Unitized Wheels	50
Drive Arbors	129	Solutions Showcases		Upholstery/Spotting Brush	157
End Brushes	116, 123	Coated Abrasives	24-25	Upright Brooms	154
Engineered Products	113	Nylox Brushes	104-105	Utility Brushes	159
Tube Brushes	118-119	Power Brushes	54-55	Utility Scrub Brushes	158
Wheel Brushes	116, 124-127	Spanner Wrench	17, 31, 43, 45	<b>V</b>	
Nylon Tube Brushes	90, 160	Spoke Brush	157	Valve Guide Brushes	90
Nylon Wheels	78	Squeegees	156	Varnish Brushes	171, 173
Nylox Nylon Abrasive Filament Brushes	115-127	Steel Flanges	128	Vat Brush	160
Nylox Technical Information	106-112	Stem-Mounted Brushes		Vehicle Care Brushes	157
<b>O</b>		Circular Flared	85, 133	Vehicle Wash Brushes	157
Ordering Information	7	Concave	77	Vending Ready Products	131-135
<b>P</b>		Conflex Brushes	76-77, 130, 132, 139	<b>W</b>	
Paint Brushes	171-173	Controlled Flare	84	Wall Dusting Brush	162
Paint Brush Technical Information	170	Crimped Wire Cup	81, 133	Wall Paint Brushes	171
Paint Rollers and Frames	177	Crimped Wire End	83-85, 133, 140	Watercolor Brushes	175
Paint Trays	177	Crimped Wire Wheels (Conflex)	76-77, 132, 139	Weld Cleaning Brushes	68-69, 132, 138
Parts Cleaning Brushes	173	Encapsulated	84-85	Wet Mops	161
Pencil End Brushes	85	Knot Wire End	82, 133, 140	Wheel Brushes	
Percolator Brushes	160	Knot Wire Wheels	67, 132, 138	Abrasive Flap	35, 46-47, 51
Perma-Sweep Floor Brushes	148	Miniature	95	Crimped Wire-Bench Grinder	71
Pilot Bonding Brushes	84	Nylon Abrasive Filament (Nylox)	116, 123	Crimped Wire-Encapsulated	71-73
Pipeliner Wheels	21	Pencil End	85	Crimped Wire-Medium Face	72
Plastic Adapters	65, 75, 115, 129	Pilot Bonding	84	Crimped Wire-Non-Sparking	94
Plater's Brushes	166	Stencil Brushes	176	Crimped Wire-Wide Face	73
Plater's Brass Wire Wheels	72	Street Brooms	151	Knot Wire-Bevel Brushes	67
Power Brushes	53-101	Stringer Bead Brushes	68-69, 132, 138	Knot Wire-Cable Twist	65, 132, 138
Power Brush Technical Information	54-62	Strip Brooms	150	Knot Wire-Encapsulated	69
Pressboard Adapters	128	Strip Brushes	96-99	Knot-Wire Non-Sparking	94
Pro-Flex™ Sweeps	147	Stylus Brush	176	Knot Wire-Standard Twist	63-66, 132, 138
Professional Paint Brushes	171-172	Surface Conditioning Discs	52	Knot Wire-Stringer Bead Twist	68-69, 132, 138
Push Brooms	146-151	<b>T</b>		Miniature	95
Push Broom Handles	152-153	Tampico Wheels	78	Nylon	78
<b>R</b>		Technical Information		Nylon Abrasive Filament (Nylox)	115, 124-127
Radiator Brush	162, 173	Abrasive Flap Discs	26-27	Plater's	72
Resin Fiber Discs	42-43	Bonded Abrasives	10-13	Small Diameter (Copper Center)	74-75
Roof Brushes	163	Maintenance Products	144-145	Stem-Mounted	76-77, 130, 132
Roughneck® Pipeline Grinding Wheel	21	Non-Woven Abrasives	50	Tampico	78
Roughneck® Weld Cleaning Brushes	68, 132, 138	Nylon Abrasive Filament Brushes (Nylox)	104-114	Whisk Brooms	154
<b>S</b>		Paint & Varnish	170	Whitewash Brush	163
Saber Tooth™		Power Brushes	54-62	Wide Face Brushes	100-101
Blending Discs	44	Tiger® Abrasive Flap Discs	30-31	Window Brushes	156
Flap Discs	36, 135	Tiger Angled Flap Discs	34-35	Window Squeegees	156
Resin Fiber Discs	42	Tiger Big Cat® Flap Discs	32, 135	Wire Brooms	151
Safety Information	8	Tiger BobCat™ Flap Discs	37	Wire Duster	167
Sash Brushes	171-172	Tiger Paw™ Abrasive Flap Discs	38-39, 135	Wire Stripping Brushes	75
Scratch Brushes	134, 165-167	Tiger Trim Flap Discs	33, 135	Wolverine™	
Scrub Brushes	158-159	Tiger X Flap Discs	28-29	Cutting Wheels	16-17
Selection Guides		Tiger Flap Wheels	46	Grinding Wheels	19
Product Selection Guide	5	Tire Cleaning Brush	157	Snagging Wheels	19
Bonded Abrasives	10-12	TRIM-KUT Discs	45	Combo Wheels	21
Coated Abrasives	26-27	Troubleshooting Guides		Flap Discs	40-41, 135
Power Brushes	56	Power Brushes	62	Flap Wheels	47, 135
Cup Brush Size Selection	79	Nylox	114	Knot Wire Wheels	63, 66, 69
Tube Brushes	87	Tube Brushes		Crimped Wire Wheels	71-73, 76-77
Maintenance Products	144-145, 170, 177	Non-Sparking	95	Wire Cup Brushes	60-61
Shell Mill Holder Disc Brushes	120	Nylon	90, 160	Wire End Brushes	82-83
		Nylon Abrasive Filament (Nylox)	118-119		
		Wire	87-91, 134		
		Tube Fitting Brushes	134, 169		

# ITEM NUMBER INDEX

Item No.	Page	Item No.	Page	Item No.	Page	Item No.	Page	Item No.	Page	Item No.	Page
00104.....	70	01509.....	71	03890.....	128	06788.....	37	08310.....	64	08878.....	65
00105.....	70	01511.....	71	03892.....	128	07700.....	129	08314.....	63	08879.....	65
00114.....	70	01512.....	71	03893.....	128	07701.....	129	08319.....	64	09379.....	65
00124.....	70	01513.....	71	03895.....	128	07702.....	129	08325.....	63	09719.....	63
00134.....	70	01514.....	71	03910.....	128	07703.....	129	08330.....	64	09790.....	64
00135.....	70	01515.....	71	03911.....	128	07715.....	129	08339.....	64	09799.....	64
00144.....	70	01517.....	71	03912.....	128	07718.....	129	08345.....	63	09800.....	64
00154.....	70	01518.....	71	03913.....	128	07721.....	75, 115	08346.....	66	09809.....	64
00156.....	76	01675.....	70	03915.....	128	07722.....	75	08375.....	63	09840.....	64
00184.....	70	01695.....	70	03920.....	128	07723.....	75, 115	08395.....	63	09856.....	68
00204.....	70	01705.....	70	03921.....	128	07724.....	75, 115	08534.....	65	09866.....	68
00214.....	70	01775.....	70	03922.....	128	07725.....	75, 115	08534V.....	132	09960.....	64
00234.....	70	01795.....	70	03923.....	128	07726.....	75	08565.....	65	09969.....	64
00244.....	70	01805.....	70	03925.....	128	07727.....	75	08565V.....	132	09870.....	63
00264.....	70	01809.....	70	03931.....	128	07729.....	75, 115	08750.....	68	09980.....	64
00274.....	70	01898.....	70	03933.....	128	07746.....	67	08756.....	68	09989.....	64
01035.....	70	01939.....	70	03934.....	128	07756.....	46	08756V.....	132	09990.....	64
01045.....	70	01949.....	70	03936.....	128	07761.....	50	08766.....	68	09999.....	64
01049.....	70	02325.....	72	03944.....	128	07764.....	50	08766V.....	132	10001.....	83
01055.....	70	02325P.....	138	03945.....	128	07766.....	37	08775.....	68	10001V.....	133
01065.....	70	02335.....	72	03946.....	128	07769.....	67	08776.....	68	10002.....	83
01068.....	70	02335P.....	138	03954.....	128	07771.....	67	08776P.....	138	10003.....	83
01075.....	70	03000.....	73	03955.....	128	07771P.....	139	08776V.....	132	10004.....	83
01075P.....	138	03010.....	73	03956.....	128	07772.....	67	08786.....	68	10005.....	83
01085.....	71	03020.....	73	03960.....	128	07772P.....	139	08796.....	68	10005V.....	133
01095.....	71	03030.....	73	03963.....	128	08004.....	63	08806.....	68	10006.....	83
01115.....	71	03040.....	73	03965.....	128	08014.....	63	08806V.....	132	10007.....	83
01125.....	71	03050.....	73	03973.....	128	08014P.....	138	08835.....	63	10008.....	83
01135.....	70	03060.....	73	03974.....	128	08014V.....	132	08916.....	68	10008V.....	133
01138.....	70	03070.....	73	03975.....	128	08024.....	63	08926.....	68	10009.....	83
01145.....	70	03090.....	73	03991.....	86, 118	08034.....	63	08954.....	68	10009V.....	133
01148.....	70	03100.....	73	03993.....	118	08044.....	63	08975.....	63	10010.....	83
01155.....	70	03110.....	73	04400.....	75, 115, 129	08044P.....	138	09000.....	68	10010V.....	133
01158.....	70	03130.....	73	04401.....	75, 115, 129	08045.....	63	09000P.....	138	10011.....	83
01165.....	70	03140.....	73	04402.....	75, 115, 129	08064.....	63	09000V.....	132	10012.....	83
01168.....	70	03150.....	73	04403.....	75	08075.....	63	09020.....	64	10012P.....	140
01175.....	70	03160.....	73	04455.....	65	08085.....	63	09049.....	64	10012V.....	133
01175P.....	138	03180.....	73	06020.....	72	08085P.....	138	09080.....	64	10013.....	83
01178.....	70	03190.....	73	06040.....	72	08095.....	63	09089.....	64	10013V.....	133
01179.....	70	03200.....	73	06050.....	72	08105.....	63	09100.....	68	10014.....	83
01228.....	70	03210.....	73	06060.....	72	08106.....	66	09104.....	64	10015.....	83
01238.....	70	03220.....	73	06070.....	72	08125.....	63	09134.....	64	10016.....	83
01248.....	70	03230.....	73	06080.....	72	08135.....	63	09160.....	64	10017.....	83
01250-12.....	70	03240.....	73	06090.....	72	08138.....	63	09180.....	64	10017V.....	133
01258.....	70	03403.....	128	06100.....	72	08145.....	63	09200.....	68	10018.....	83
01259.....	70	03404.....	128	06110.....	72	08155.....	63	09386.....	68	10019.....	83
01299.....	70	03405.....	128	06120.....	72	08178.....	63	09396.....	68	10020.....	83
01309.....	70	03480.....	73	06150.....	72	08179.....	63	09400.....	68	10021.....	83
01319.....	70	03510.....	73	06160.....	72	08189.....	63	09400P.....	138	10021V.....	133
01320-14.....	70	03520.....	73	06170.....	72	08200-14.....	63	09400V.....	132	10022.....	83
01329.....	70	03590.....	73	06180.....	72	08209.....	63	09410.....	64	10022V.....	133
01339.....	70	03680.....	73	06190.....	72	08219.....	63	09430.....	64	10023.....	83
01349.....	70	03809.....	72, 78, 128	06200.....	72	08249.....	63	09440.....	64	10024.....	83
01415.....	94	03810.....	72, 78, 128	06440.....	72	08254.....	63	09460.....	64	10025.....	82
01475.....	94	03811.....	72, 78, 128	06450.....	72	08264.....	63	09480.....	64	10025P.....	140
01501.....	71	03812.....	72, 78, 128	06490.....	72	08264V.....	132	09490.....	64	10026.....	82
01502.....	71	03813.....	72, 78, 128	06620.....	72	08271.....	94	09500.....	68	10026P.....	140
01503.....	71	03814.....	72, 78, 128	06530.....	72	08274.....	63	09510.....	64	10026V.....	133
01504.....	71	03824.....	72, 78, 128	06645.....	73	08284.....	63	09530.....	64	10027.....	82
01505.....	71	03833.....	47	06645P.....	138	08294.....	63	09540.....	64	10027P.....	140
01506.....	71	03834.....	47	06655.....	73	08300.....	64	08615.....	65	10027V.....	133
01508.....	71	03835.....	47	06777.....	37	08309.....	64	08695.....	65	10028.....	82



# ITEM NUMBER INDEX

Item No.	Page	Item No.	Page	Item No.	Page	Item No.	Page	Item No.	Page	Item No.	Page
10028P	140	10218	82	11162	116, 123	13105	66	13238	68	14206	81, 133
10028V	133	10220	82	11165	116, 123	13106	66	13240	81	14216	81
10029	82	10301	84	11166	116, 123	13106P	138	13240P	139	14256	81
10029V	133	10302	84	11169	116, 123	13106V	132	13241	81	14300	81
10030	82	10303	84	11170	116, 123	13107	66	13242	81	14301	81
10031	82	10305	84	12120	80	13108	66	13243	81	14301V	133
10031V	133	10306	84	12206	79	13109	66	13244	81	14302	81, 133
10032	82	10307	84	12256	79	13110	66	13245	81, 133	14303	81
10033	85	10309	84	12276	79, 133	13113	66	13245P	139	14304	81
10034	85	10310	84	12276P	139	13113P	138	13249	68	14306	81
10035	85	10311	84	12301	80	13113V	132	13253	79	14310	95
10037	85	10313	84	12306	79	13114	66	13254	79	14311	95
10038	85	10314	84	12316	79, 133	13115	66	13255	79	14313	81
10039	85	10315	84	12316P	139	13116	66	13256	79	14314	95
10040	85	10317	84	12326	79	13117	66	13257	79	14315	81
10041	85	10319	84	12356	79, 133	13119	66	13258	79, 133	14316	95
10041V	133	10321	84	12376	79, 133	13120	66	13261	66	14317	81
10042	85	10322	84	12376P	139	13120V	132	13266	66	14318	81
10043	85	10323	84	12396	79	13121	94	13266P	138	14319	81
10044	85	10370	83	12406	79	13124	68	13266V	132	14320	81
10045	85	10371	83	12416	79	13125	68	13272	66	14321	81
10046	85	10372	83	12456	79	13125P	138	13276	66	14401	117
10047	85	10373	83	12476	79	13126	68	13281	79	14403	117
10048	85	10374	83	12536	80	13127	68	13281P	139	14404	117
10050	85	10375	83	12556	80	13128	68	13282	79	14413	117
10056	84	10376	83	12576	80	13131	68	13283	79	14414	117
10057	84	10377	83	12636	80	13131P	138	13284	79	14506	117
10058	84	10378	83	12676	80	13131V	132	13285	79	14516	117
10059	84	10379	83	12686	80	13130	68	13286	79, 133	14576	117
10067	95	10380	83	12726	80	13132	68	13286P	139	14606	95
10073	85	10381	83	12736	79	13134	68	13299	94	14616	95
10074	85	10387	82	12746	79	13135	68	13300	80	15071	74
10076	85	10388	82	12756	80	13137	68	13301	80	15101	74
10091	95	10392	82	12766	80	13138	68	13302	80	15111	74
10099	85	10393	82	12776	94	13138P	138	13401	67	15131	74
10128	95	11000	83	12796	80	13138V	132	13402	67	15141	74
10134	85	11001	83	12816	79	13150	79	13406	67	15151	74
10141	82	11003	83	12826	79	13151	79	13416	67	15302	74
10141V	133	11004	83	12846	79	13152	79	13423	67	15312	74
10142	82	11006	83	12856	79	13153	79	13426	67	15322	74
10150	85	11007	83	12866	79	13155	79	13436	67	15332	74
10151	85	11010	83	12886	79	13156	79, 133	13456	67	15433	74
10152	116, 123	11011	83	12906	80	13156P	139	13466	67	15443	74
10153	116, 123	11013	83	12916	80	13159	79	13476	67	15453	74
10154	116, 123	11014	83	12926	80	13160	79	13486	67	15463	74
10155	116, 123	11016	83	13001	141	13163	79, 133	13709	79	15473	74
10156	116, 123	11017	83	13002	141	13175	81	13710	79	15513	74
10157	116, 123	11100	84	13009	79	13176	81	13711	79	15523	74
10158	95	11101	84	13015	79	13177	81	13712	79	15533	74
10172	116, 123	11102	84	13016	79	13178	81	13715	79	15543	74
10173	116, 123	11103	84	13020	79	13181	81, 133	13716	79	15553	74
10174	116, 123	11105	84	13021	79	13182	81	13717	79	15563	74
10187	82	11110	84	13025	79, 133	13184	81	13718	79	15573	74
10188	83	11112	84	13025P	139	13185	81	14016	81	15637	74
10208	82	11113	84	13077	76	13187	81	14026	81, 133	15647	74
10210	82	11114	84	13078	76	13188	81	14036	81	15667	74
10211	82	11115	84	13081	76	13201	66	14036P	139	15677	74
10212	82	11140	82	13085	76	13208	66	14066	81, 133	15732	74
10213	82	11141	82	13100	66	13231	95	14076	81	15753	74
10215	82	11142	85	13101	66	13232	68	14076P	139	15762	74
10216	82	11160	116, 123	13102	66	13232V	132	14126	81	15863	74
10217	82	11161	116, 123	13103	66	13234	68	14166	81	16263	115

# ITEM NUMBER INDEX

Item No.	Page	Item No.	Page	Item No.	Page	Item No.	Page	Item No.	Page	Item No.	Page
16315.....	115	17611.....	76	17961.....	77	21073V.....	134	21128.....	119	21332.....	95
16316.....	115	17611V.....	132	17962.....	77	21074.....	88	21130.....	119	21340.....	88
16461.....	74	17612.....	76	17963.....	77	21074V.....	134	21132.....	119	21342.....	87
16471.....	74	17614.....	76	17964.....	77	21075.....	88	21133.....	119	21345.....	119
16511.....	74	17615.....	76	17965.....	77	21075V.....	134	21134.....	119	21404.....	88
16521.....	74	17615P.....	139	17966.....	77	21076.....	88	21136.....	119	21413.....	87
16702.....	74	17615V.....	132	17967.....	77	21077.....	88	21138.....	119	21414.....	89
16712.....	74	17616.....	76	17968.....	77	21077V.....	134	21139.....	95	21473.....	119
16833.....	74	17616V.....	132	17969.....	77	21078.....	88	21142.....	88	21757.....	119
16843.....	74	17617.....	76	17971.....	77	21078V.....	134	21143.....	88	21758.....	119
16853.....	74	17617P.....	139	17972.....	77	21079.....	88	21144.....	88	21759.....	119
16873.....	74	17618.....	76	17973.....	77	21080.....	88	21146.....	88	21760.....	119
16933.....	74	17618V.....	132	17974.....	77	21081.....	88	21148.....	88	21761.....	119
16943.....	74	17619.....	77	17975.....	77	21081V.....	134	21149.....	88	21762.....	119
16963.....	74	17620.....	77	17976.....	77	21082.....	88	21150.....	88	21763.....	119
16973.....	74	17621.....	77	17977.....	77	21083.....	88	21152.....	95	21764.....	119
17202.....	86	17622.....	77	17978.....	77	21084.....	88	21161.....	89	21765.....	119
17203.....	86	17623.....	77	17979.....	77	21085.....	88	21162.....	89	21976.....	119
17205.....	86	17628.....	115	17981.....	77	21086.....	88	21164.....	87	22021.....	72
17206.....	118	17629.....	115	17982.....	77	21087.....	88	21165.....	95	22241.....	72
17207.....	86	17633.....	115	20180.....	78	21088.....	88	21167.....	87	22061.....	72
17208.....	118	17637.....	77	20190.....	78	21089.....	88	21175.....	88	22602.....	119
17209.....	86	17641.....	94	20490.....	78	21090.....	89	21178.....	95	22603.....	119
17210.....	118	17641V.....	132	20510.....	78	21091.....	89	21179.....	95	22604.....	119
17211.....	86	17680.....	67	20600.....	125	21092.....	89	21181.....	88	22605.....	119
17212.....	118	17681.....	67	20610.....	125	21093.....	89	21182.....	95	22606.....	119
17214.....	86	17681V.....	132	20620.....	125	21094.....	89	21184.....	87	22607.....	119
17215.....	118	17682.....	67	20630.....	125	21095.....	89	21191.....	95	22608.....	119
17216.....	86	17684.....	67	20650.....	125	21096.....	89	21203.....	88	22610.....	119
17217.....	118	17686.....	67	20661.....	125	21097.....	89	21218.....	95	22614.....	119
17218.....	86	17687.....	67	20730.....	125	21098.....	89	21219.....	95	22616.....	119
17219.....	86	17687V.....	132	21000.....	89	21099.....	89	21221.....	95	25100.....	165
17223.....	78	17689.....	67	21001.....	89	21100.....	89	21232.....	87	25104.....	165
17233.....	78	17691.....	67	21004.....	89	21101.....	89	21233.....	89	25150.....	165
17263.....	78	17901.....	77	21005.....	89	21103.....	89	21236.....	87	25154.....	165
17443.....	78	17902.....	77	21008.....	89	21104.....	89	21240.....	88	25201.....	165
17453.....	78	17903.....	77	21009.....	89	21105.....	89	21245.....	87	25202.....	165
17532.....	115	17906.....	77	21014.....	89	21106.....	87	21246.....	89	25211.....	166
17533.....	115	17907.....	77	21015.....	89	21107.....	87	21247.....	87	25212.....	167
17535.....	115	17909.....	77	21020.....	89	21107V.....	134	21249.....	89	25221.....	172
17541.....	115	17912.....	77	21021.....	89	21108.....	87	21252.....	87	25222.....	172
17542.....	115	17914.....	77	21023.....	89	21108V.....	134	21264.....	88	25231.....	149
17543.....	115	17915.....	77	21025.....	89	21109.....	87	21265.....	88	25232.....	149
17548.....	115	17917.....	77	21027.....	89	21110.....	87	21266.....	88	25234.....	149
17551.....	115	17922.....	77	21028.....	89	21110V.....	134	21267.....	88	25235.....	149
17555.....	115	17923.....	77	21030.....	89	21111.....	87	21269.....	88	25238.....	151
17556.....	115	17930.....	77	21031.....	89	21112.....	87	21270.....	95	25239.....	151
17557.....	115	17931.....	77	21034.....	89	21113.....	87	21282.....	88	25241.....	151
17563.....	115	17933.....	77	21035.....	89	21114.....	87	21304.....	119	25242.....	151
17565.....	115	17935.....	77	21036.....	89	21114V.....	134	21305.....	119	25251.....	155
17567.....	115	17936.....	77	21040.....	89	21115.....	87	21306.....	119	25252.....	155
17568.....	115	17937.....	77	21041.....	89	21116.....	87	21308.....	119	25262.....	159
17600.....	77	17950.....	77	21044.....	89	21117.....	87	21309.....	119	25263.....	159
17601.....	77	17951.....	77	21050.....	89	21118.....	87	21311.....	119	25271.....	156
17602.....	77	17952.....	77	21051.....	89	21119.....	87	21312.....	119	25290.....	150
17603.....	77	17953.....	77	21053.....	89	21120.....	87	21322.....	88	25291.....	150
17604.....	77	17954.....	77	21055.....	89	21121.....	87	21325.....	119	25294.....	150
17605.....	77	17955.....	77	21056.....	89	21122.....	87	21326.....	119	25295.....	150
17608.....	77	17956.....	77	21057.....	89	21123.....	87	21327.....	119	25297.....	152
17609.....	76	17957.....	77	21058.....	89	21124.....	87	21328.....	119	25299.....	150
17610.....	76	17958.....	77	21072.....	88	21125.....	87	21329.....	119	26000.....	92
17610V.....	132	17959.....	77	21073.....	88	21126.....	119	21330.....	119	26001.....	92

# ITEM NUMBER INDEX

Item No.	Page	Item No.	Page	Item No.	Page	Item No.	Page	Item No.	Page	Item No.	Page
26003.....	92	26912.....	118	31275.....	126	31422.....	41	36216.....	66	40027.....	174
26004.....	92	26913.....	118	31280.....	126	35006.....	80	36217.....	66	40028.....	174
26005.....	92	26914.....	118	31285.....	126	35070.....	75	36218.....	69	40029.....	174
26012.....	92	26915.....	118	31290.....	126	35084.....	71	36219.....	69	40030.....	174
26014.....	92	29059.....	94	31307.....	40	35105.....	71	36224.....	66	40031.....	174
26015.....	92	29070.....	78	31308.....	40	35117.....	71	36225.....	69	40032.....	174
26016.....	92	29078.....	94	31309.....	40	35135.....	71	36226.....	63	40035.....	172
26017.....	92	29086.....	94	31310.....	40	35160.....	73	36227.....	63	40036.....	172
26021.....	92	29088.....	115	31313.....	40	35186.....	80	36228.....	63	40040.....	171
26041.....	92	29123.....	115	31314.....	40	35206.....	69	36230.....	81	40041.....	171
26042.....	92	29178.....	94	31315.....	40	35216.....	69	36231.....	81	40056.....	172
26043.....	92	29280.....	115	31316.....	40	35222.....	85	36232.....	81	40058.....	171
26059.....	92	29353.....	115	31317.....	40	35223.....	85	36236.....	81	40059.....	171
26071.....	92	29356.....	115	31331.....	40	35224.....	85	36237.....	81	40060.....	171
26072.....	92	30720.....	47	31332.....	40	35226.....	85	36238.....	80	40061.....	171
26074.....	92	30720V.....	135	31333.....	40	35233.....	85	36239.....	80	40062.....	171
26075.....	92	30721.....	47	31334.....	40	35234.....	85	36244.....	80	40065.....	174
26076.....	92	30721V.....	135	31337.....	40	35240.....	75	36245.....	80	40066.....	174
26091.....	92	30722.....	47	31338.....	40	35250.....	75	36250.....	82	40067.....	174
26093.....	92	30723.....	47	31339.....	40	35260.....	75	36251.....	82	40068.....	174
26094.....	92	30723V.....	135	31340.....	40	35293.....	75	36255.....	66	40069.....	174
26095.....	92	30724.....	47	31343.....	40	35294.....	75	36257.....	66	40070.....	174
26096.....	92	30724V.....	135	31344.....	40	35305.....	76	36258.....	66	40071.....	174
26097.....	93	30725.....	47	31345.....	40	35310.....	76	36259.....	77	40074.....	173
26098.....	93	30726.....	47	31346.....	40	35315.....	76	36262.....	71	40076.....	174
26099.....	93	30726V.....	135	31347.....	40	35340.....	84	36265.....	73	40077.....	176
26101.....	93	30727.....	47	31349.....	40	35345.....	84	36279.....	63	40078.....	176
26106.....	93	30727V.....	135	31350.....	40	35350.....	84	36282.....	83	40080.....	176
26107.....	93	30728.....	47	31351.....	40	35406.....	80	36283.....	83	40082.....	176
26108.....	93	30735.....	47	31352.....	40	35416.....	76	36284.....	83	40089.....	173
26113.....	93	30736.....	47	31353.....	40	35500.....	84	36285.....	83	40101.....	173
26114.....	93	30737.....	47	31355.....	40	35505.....	84	36286.....	82	40103.....	173
26115.....	93	30738.....	47	31356.....	40	35520.....	71	36287.....	82	40104.....	173
26116.....	93	30745.....	47	31357.....	40	35530.....	80	36288.....	82	40106.....	171
26119.....	93	30746.....	47	31358.....	40	35535.....	84	36289.....	82	40107.....	173
26122.....	93	31074.....	126	31361.....	40	35540.....	84	36290.....	63	40108.....	173
26121.....	93	31084.....	126	31362.....	40	35545.....	84	36293.....	63	40109.....	173
26128.....	93	31094.....	126	31363.....	40	35600.....	69	36295.....	69	40110.....	173
26131.....	93	31100.....	126	31364.....	40	35760.....	80	36296.....	69	40111.....	173
26133.....	93	31101.....	126	31367.....	40	35821.....	88	36303.....	169	40113.....	171
26136.....	93, 116, 123	31102.....	126	31368.....	40	35822.....	88	36304.....	169	40114.....	171
26138.....	93, 116, 123	31103.....	126	31369.....	40	35823.....	88	36305.....	169	40115.....	171
26140.....	92	31104.....	126	31370.....	40	35825.....	88	36307.....	69	40116.....	172
26141.....	92	31105.....	126	31387.....	41	36246.....	83	36297.....	69	40118.....	172
26143.....	92	31110.....	126	31388.....	41	36247.....	83	36512.....	17	40119.....	172
26144.....	92	31111.....	130	31389.....	41	36248.....	83	36666.....	161	40120.....	172
26146.....	93, 116, 123	31112.....	130	31390.....	41	36249.....	83	40000.....	171	40121.....	172
26155.....	92	31114.....	126	31391.....	41	35800.....	69	40001.....	171	40122.....	172
26294.....	92	31121.....	126	31392.....	41	35808.....	75	40002.....	171	40137.....	174
26296.....	92	31122.....	126	31401.....	41	36200.....	71	40004.....	171	40139.....	174
26900.....	118	31123.....	126	31402.....	41	36201.....	71	40008.....	171	40140.....	174
26901.....	118	31124.....	126	31403.....	41	36203.....	72	40010.....	171	40141.....	174
26902.....	118	31134.....	126	31404.....	41	36204.....	73	40011.....	171	40160.....	174
26903.....	118	31135.....	126	31407.....	41	36205.....	71	40014.....	171	40161.....	174
26904.....	118	31136.....	126	31408.....	41	36206.....	73	40017.....	171	40162.....	174
26905.....	118	31137.....	126	31409.....	41	36207.....	76	40018.....	171	40163.....	174
26906.....	118	31240.....	126	31410.....	41	36208.....	77	40019.....	172	40164.....	174
26907.....	118	31241.....	126	31414.....	41	36209.....	77	40020.....	172	40165.....	174
26908.....	118	31245.....	126	31415.....	41	36211.....	77	40021.....	172	40166.....	174
26909.....	118	31255.....	126	31419.....	41	36212.....	66	40022.....	171	40177.....	174
26910.....	118	31265.....	126	31420.....	41	36213.....	66	40023.....	171	40179.....	174
26911.....	118	31270.....	126	31421.....	41	36215.....	66	40026.....	174	40180.....	174



# ITEM NUMBER INDEX

Item No.	Page	Item No.	Page	Item No.	Page	Item No.	Page	Item No.	Page	Item No.	Page
40181	174	42166	148	44058	165	44159	168	44735	169	44871	150
40182	174	42167	148	44061	165	44167	166	44736	169	44872	150
40183	174	42168	148	44062	165	44167V	134	44737	169	44873	151
40184	174	42173	151	44063	134, 165	44169	168	44738	169	44874	151
40185	174	42174	151	44064	134, 165	44189	166	44739	169	44879	164
41000	175	42210	157	44065	165	44189V	134	44805	167	44880	164
41001	175	42213	155	44066	167	44213	90, 160	44806	167	44881	164
41002	175	42352	146	44067	167	44232	166	44810	167	44882	164
41003	175	42353	146	44069	166	44235	165	44875	157	44883	163
41004	175	42354	146	44070	167	44240	166	45500	156	44884	163
41005	175	42355	146	44073	167	44251	166	45506	156	44885	150
41007	175	42356	146	44074	167	44260	167	45507	156	49008	177
41008	175	42357	146	44075	166	44261	176	45510	156	49010	177
41009	175	42360	146	44075V	134	44262	176	45511	156	49011	177
41010	175	42365	146	44076	166	44263	176	45534	156	49015	177
41011	175	42368	146	44077	166	44266	154	45535	156	49016	177
41012	175	42371	146	44078	169	44290	153	45537	156	49018	177
41013	175	42372	146	44079	169	44299	165	45538	156	49019	177
41018	175	42373	146	44080	169	44300	152	44553	148	49020	177
41019	175	42375	146	44080V	134	44301	152	44561	153	49022	177
41020	175	42376	146	44081	169	44302	152	44562	153	49025	177
41021	175	42380	146	44082	169	44303	152	44563	153	49044	177
41022	175	42381	146	44083	169	44305	154	44571	152	49045	177
41023	175	42382	146	44084	169	44306	152	44572	152	49046	177
41024	175	42383	152	44085	169	44307	157	44573	152	49050	177
41025	175	44001	160	44086	169	44314	160	44574	152	49051	177
42001	149	44003	155	44087	169	44315	157	44577	152	49052	177
42002	149	44004	155	44088	176	44316	90, 160	44578	152	49053	177
42006	149	44007	154	44088V	134	44317	153	44581	148	49061	177
42007	149	44008	154	44089	176	44318	157	44582	148	49062	177
42008	149	44009	154	44089V	134	44319	153	44584	148	49063	177
42013	149	44010	163	44090	176	44351	155	44587	148	49066	177
42014	149	44011	163	44090V	134	44354	155	44590	148	49070	177
42016	149	44013	159	44097	176	44391	158	44591	148	49071	177
42017	149	44014	159	44099	154	44395	158	44600	147	50002	33
42021	151	44016	159	44100	165	44416	159	44601	147	50003	33
42022	151	44017	159	44101	165	44418	159	44604	147	50004	33
42023	151	44018	152	44103	154	44428	158	44606	147	50005	33
42025	151	44019	152	44110	90, 160	44429	158	44624	153	50006	33
42026	151	44020	152	44111	90, 160	44432	165	44635	152	50006V	135
42030	151	44021	153	44112	90, 160	44434	158	44637V	134	50105V	135
42032	151	44023	158	44113	90, 160	44435	152	44692	158	50106V	135
42033	151	44024	158	44114	90, 160	44438	158	44693	158	50007	33
42035	149	44025	158	44115	90, 160	44448	163	44699	158	50007V	135
42037	149	44026	158	44116	166	44451	167	44819	149	50008	33
42041	149	44027	158	44117	166	44499	153	44851	149	50009	33
42042	149	44028	158	44118	166	44510	157	44852	149	50010	33
42047	149	44029	158	44119	166	44546	154	44853	149	50011	33
42049	149	44031	163	44124	168	44547	154	44855	149	50012	33
42095	149	44032	163	44125	168	44548	154	44856	149	50014	33
42098	149	44034	163	44128	168	44551	166	44857	149	50015	33
42099	151	44035	168	44131	168	44594	165	44858	149	50016	33
42054	151	44036	168	44133	168	44609	166	44859	149	50100	36
42055	151	44037	168	44135	168	44619	166	44860	149	50101	36
42114	149	44047	168	44137	168	44637	166	44861	149	50102	36
42134	150	44038	168	44139	168	44660	166	44862	149	50103	36
42135	150	44048	168	44144	130	44663	159	44863	151	50104	36
42138	151	44053	134, 165	44149	168	44690	169	44864	151	50105	36
42149	151	44054	134, 165	44150	168	44731	166	44865	151	50106	36
42163	148	44055	165	44152	168	44732	166	44866	151	50107	36
42164	148	44056	165	44154	168	44733	166	44867	151	50108	36
42165	148	44057	165	44156	168	44734	169	44868	151	50109	36

# ITEM NUMBER INDEX

Item No.	Page	Item No.	Page	Item No.	Page	Item No.	Page	Item No.	Page	Item No.	Page
50110.....	36	50541.....	30	50770.....	32	50965.....	37	51201.....	29	51434.....	51
50111.....	36	50542.....	30	50783.....	32	51101.....	39	51201V.....	135	51444.....	51
50112.....	36	50543.....	30	50784.....	32	51102.....	39	51202.....	29	51454.....	51
50113.....	36	50544.....	30	50786.....	32	51104.....	38	51202V.....	135	51456.....	51
50114.....	36	50545.....	30	50803.....	32	51105.....	38	51203.....	29	51457.....	51
50115.....	36	50546.....	30	50803V.....	135	51107.....	39	51204.....	29	51458.....	51
50117.....	36	50562.....	30	50804.....	32	51108.....	39	51205.....	29	51460.....	51
50118.....	36	50563.....	30	50804V.....	135	51109.....	39	51205V.....	135	51506.....	52
50119.....	36	50564.....	30	50805.....	32	51110.....	39	51206.....	29	51507.....	52
50121.....	36	50565.....	30	50806.....	32	51112.....	39	51206V.....	135	51508.....	52
50122.....	36	50572.....	30	50808.....	32	51113.....	39	51207.....	29	51512.....	52
50123.....	36	50573.....	30	50808V.....	135	51114.....	39	51208.....	29	51513.....	52
50130.....	36	50574.....	30	50809.....	32	51115.....	39	51209.....	29	51514.....	52
50131.....	36	50575.....	30	50809V.....	135	51118.....	38	51210.....	29	51515.....	52
50132.....	36	50582.....	30	50810.....	32	51119.....	38	51211.....	29	51516.....	52
50133.....	36	50583.....	30	50823.....	32	51119V.....	135	51212.....	29	51517.....	52
50134.....	36	50585.....	30	50824.....	32	51120.....	38	51213.....	29	51521.....	52
50135.....	36	50601.....	30	50825.....	32	51120V.....	135	51214.....	29	51522.....	52
50136.....	36	50606.....	30	50833.....	32	51121.....	38	51215.....	29	51523.....	52
50137.....	36	50616.....	30	50834.....	32	51123.....	38	51216.....	29	51530.....	52
50138.....	36	50632.....	30	50843.....	32	51124.....	38	51217.....	29	51531.....	52
50139.....	36	50633.....	30	50844.....	32	51124V.....	135	51218.....	29	51532.....	52
50140.....	36	50634.....	30	50845.....	32	51125.....	38	51219.....	29	51533.....	52
50141.....	36	50635.....	30	50846.....	32	51125V.....	135	51220.....	29	51534.....	52
50592.....	30	50649.....	30	50902.....	37	51126.....	38	51221.....	29	51535.....	52
50552.....	30	50650.....	30	50903.....	37	51129.....	38	51222.....	29	51551.....	43, 44, 52
50502.....	30	50651.....	30	50904.....	37	51130.....	38	51223.....	29	51552.....	43, 44, 52
50593.....	30	50653.....	31	50905.....	37	51132.....	38	51224.....	29	51562.....	52
50553.....	30	50654.....	31	50906.....	37	51133.....	38	51225.....	29	51569.....	52
50503.....	30	50655.....	31	50912.....	37	51134.....	39	51226.....	29	51575.....	52
50594.....	30	50659.....	30	50913.....	37	51135.....	39	51227.....	29	51578.....	52
50554.....	30	50660.....	30	50914.....	37	51137.....	39	51228.....	29	52003.....	46
50504.....	30	50661.....	30	50915.....	37	51138.....	39	51229.....	29	52004.....	46
50595.....	30	50663.....	31	50916.....	37	51139.....	39	51230.....	29	52005.....	46
50555.....	30	50664.....	31	50922.....	37	51140.....	39	51231.....	29	52009.....	46
50505.....	30	50665.....	31	50923.....	37	51142.....	39	51232.....	29	52010.....	46
50506.....	30	50668.....	31	50924.....	37	51143.....	39	51233.....	29	52011.....	46
50509.....	30	50669.....	31	50925.....	37	51145.....	38	51234.....	29	52015.....	46
50510.....	30	50670.....	31	50932.....	37	51146.....	38	51300.....	35	52016.....	46
50511.....	30	50673.....	31	50933.....	37	51147.....	38	51301.....	35	52017.....	46
50512.....	30	50674.....	31	50934.....	37	51148.....	38	51302.....	35	52024.....	46
50513.....	30	50675.....	31	50935.....	37	51149.....	38	51303.....	35	52025.....	46
50513V.....	135	50683.....	31	50936.....	37	51150.....	38	51304.....	35	52027.....	46
50514.....	30	50684.....	31	50946.....	37	51153.....	38	51305.....	35	52028.....	46
50514V.....	135	50693.....	31	50947.....	37	51154.....	38	51306.....	35	52029.....	46
50515.....	30	50694.....	31	50948.....	37	51155.....	39	51307.....	35	52366.....	46
50516.....	30	50695.....	31	50949.....	37	51156.....	39	51308.....	35	52367.....	46
50517.....	30	50696.....	31	50950.....	37	51157.....	39	51309.....	35	52486.....	46
50518.....	30	50699.....	31	50951.....	37	51158.....	39	51310.....	35	52487.....	46
50518V.....	135	50706.....	31	50952.....	37	51160.....	39	51311.....	35	52601.....	46
50519.....	30	50713.....	31	50953.....	37	51161.....	39	51312.....	35	52603.....	46
50519V.....	135	50714.....	31	50954.....	37	51162.....	39	51313.....	35	52605.....	46
50520.....	30	50715.....	31	50955.....	37	51163.....	39	51314.....	35	52611.....	46
50522.....	30	50733.....	31	50956.....	37	51164.....	39	51315.....	35	52613.....	46
50523.....	30	50734.....	31	50957.....	37	51165.....	39	51316.....	35	52621.....	46
50524.....	30	50735.....	31	50958.....	37	51166.....	39	51317.....	35	52623.....	46
50525.....	30	50746.....	31	50959.....	37	51167.....	39	51318.....	35	53286.....	47
50526.....	30	50763.....	32	50960.....	37	51168.....	39	51319.....	35	53287.....	47
50532.....	30	50764.....	32	50961.....	37	51169.....	39	51320.....	35	53326.....	47
50533.....	30	50765.....	32	50962.....	37	51170.....	39	51321.....	35	53327.....	47
50534.....	30	50768.....	32	50963.....	37	51171.....	39	51322.....	35	54492.....	50
50536.....	30	50769.....	32	50964.....	37	51200.....	29	51323.....	35	54500.....	51

# ITEM NUMBER INDEX

Item No.	Page	Item No.	Page	Item No.	Page	Item No.	Page	Item No.	Page	Item No.	Page
54501	51	56457	19	57134	19	58124	18	59527	42	60040	44
54502	51	56464	19	57135	19	58125	18	59528	42	60043	44
54506	51	56466	19	57136	19	58126	18	59529	42	60044	44
54507	51	56467	19	57137	19	58127	18	59543	42	60046	44
54508	51	56468	19	57401	19	58130	14	59550	42	60053	44
54509	51	56470	19	57403	19	58131	14	59551	42	60056	44
54510	51	56473	19	58000	15	58300	15	59552	42	60057	44
54511	51	56475	16	58001	15	58301	15	59553	42	60059	44
55512	50	56474	16	58002	15	58302	15	59554	42	60118	44
55513	50	56476	16	58003	15	58303	15	59557	42	60121	44
55531	50	56477	16	58005	14	58305	15	59558	42	60122	44
55530	50	56484	17, 31	58006	14	58306	15	59559	42	60124	44
55541	50	56485	45	58020	15	58307	15	59560	42	60131	44
55542	50	56489	17, 50	58021	15	58308	15	59561	42	60134	44
55543	50	56490	17	58022	15	58309	15	59564	42	60135	44
55545	50	56491	17	58023	15	58310	15	59565	42	60137	44
55546	50	56494	17, 31	58050	20	58311	15	59566	42	60150	44
56013	16	56495	17, 31	58051	20	58312	15	59567	42	60151	44
56015	16	56496	45	58052	20	58315	20	59568	42	60152	44
56061	16	57001	16	58053	20	58316	20	59571	42	60155	44
56062	16	57020	15	58054	20	58317	20	59573	42	60156	44
56065	16	57021	15	58055	20	58318	20	59575	42	60157	44
56068	16	57022	15	58056	20	58319	20	59576	42	60170	44
56070	16	57023	15	58057	20	58320	20	59577	42	60171	44
56076	16	57040	15	58058	20	58321	20	59578	42	60172	44
56080	16	57041	15	58059	21	58322	20	59579	42	60175	44
56086	16	57042	15	58060	21	58323	20	59600	43	60176	44
56099	16	57043	15	58061	21	58324	20	59601	43	60177	44
56103	16	57044	15	58062	21	58325	18	59602	43	60378	44
56108	16	57045	15	58063	21	58326	18	59603	43	60381	44
56118	16	57046	15	58064	20	58327	18	59604	43	60382	44
56131	19	57047	15	58065	21	58328	18	59605	43	60384	44
56163	19	57060	16	58070	18	58329	18	59611	43	60391	44
56230	17	57061	15	58071	18	58330	18	59701	42	60394	44
56239	17	57080	15	58072	18	58331	18	59702	42	60395	44
56240	17	57081	15	58073	18	58332	18	59711	42	60397	44
56271	16	57082	15	58074	18	58333	18	59712	42	60508	37, 43, 44
56273	16	57083	15	58075	18	58334	18	59731	42	60509	37, 43, 44
56275	16	57090	17	58076	18	59300	45	59732	42	61012	141
56277	16	57091	17	58077	18	59305	45	59733	42	65204	48
56278	16	57092	17	58078	18	59315	45	59806	43	65205	48
56279	19	57093	17	58079	18	59327	45	59807	43	65206	48
56280	19	57100	20	58080	19	59326	45	59808	43	65207	48
56281	16	57101	20	58081	19	59403	45	59809	43	65208	48
56282	16	57102	20	58082	19	59491	42	59811	43	65209	48
56283	16	57103	20	58083	19	59492	42	59812	43	65210	48
56383	16	57104	20	58107	15	59493	42	59813	43	65212	48
56384	16	57105	20	58109	15	59494	42	59814	43	65213	48
56385	16	57106	20	58110	15	59495	42	59821	43	65218	48
56391	16	57107	20	58111	15	59497	42	59823	43	65219	48
56392	16	57108	20	58112	15	59500	42	59824	43	65220	48
56393	16	57109	20	58113	15	59501	42	59826	43	65221	48
56423	16	57120	18	58114	20	59503	42	59862	43	65222	48
56425	21	57121	18	58115	20	59505	42	59864	43	65223	48
56426	21	57122	18	58116	20	59506	42	59865	43	65225	48
56427	21	57123	18	58117	20	59507	42	59869	43	65226	48
56428	21	57124	18	58118	20	59508	42	59870	43	65231	48
56429	21	57125	18	58119	20	59520	42	59871	43	65232	48
56430	21	57126	18	58120	18	59521	42	59874	43	65233	48
56449	19	57127	18	58121	18	59523	42	59875	43	65234	48
56454	19	57128	18	58122	18	59525	42	59876	43	65235	48
56455	19	57129	18	58123	18	59526	42	59877	43	65236	48



# ITEM NUMBER INDEX

Item No.	Page	Item No.	Page	Item No.	Page	Item No.	Page	Item No.	Page	Item No.	Page
65238	48	75109	161	83006	127	85150	127	86099	116, 123	86171	130
65239	48	75110	161	83007	127	85153	127	86013	117, 122	86172	130
70067	149	75117	162	83010	125	85440	127	86014	117, 122	86181	124
70068	149	75118	162	83011	125	85733	117, 122	86100	116, 123	86182	124
70208	151	75130	161	83030	125	85736	117, 122	86101	116, 123	86198	120
70209	151	75131	161	83040	125	85738	117, 122	86102	116, 123	86199	120
70210	151	75132	161	83050	125	85750	117, 122	86103	116, 123	86204	120
70211	151	75133	162	83070	125	85751	117, 122	86104	116, 123	89023	129
70212	151	75137	162	83100	125	85752	117, 122	86105	116, 123	89024	129
70215	151	75138	162	83110	125	85753	117, 122	86106	117, 122	89029	129
70300	154	75140	161	83111	125	85773	117, 122	86107	117, 122	89033	129
70304	154	75160	154	83116	127	85776	121	86108	124	94000	64
70308	154	75170	161	83130	125	85778	121	86109	117, 122	94008	65
70312	149, 157	75171	161	83140	125	85786	121	86110	117, 122	94012	80
70324	154	75172	161	83150	125	85788	121	86111	117, 122	94026	65
70325	154	75173	161	83180	127	85792	121	86112	120	94098	64
71019	155	75180	161	83190	127	85794	121	86113	120	94199	65
71076	162	75181	161	83300	127	85798	121	86114	120	94224	65
71077	155	75182	161	83310	127	85800	121	86115	120	95013	166
71078	155	75202	156	83330	127	85806	121	86116	120	95014	166
71079	155	75505	153	83340	127	85812	121	86117	120	95016	130
71080	155	75516	152	83350	127	85814	121	86120	124	95027	90
71081	155	75525	152	83393	127	85816	121	86121	120	95028	90
72034	158	75527	152	83394	124	85818	121	86122	120	95029	90
72058	158	75528	152	83405	124	85822	121	86123	124	95084	90
72086	159	75555	152	83430	127	85824	121	86124	124	95129	90
72101	159	75570	160	83440	127	85826	121	86125	120	95151	166
73050	162	77013	149	83450	127	85832	121	86126	124	95202	89
73055	162	77014	149	83513	125	85836	121	86127	124	95203	89
73111	158, 164	79101	159	83514	125	85842	121	86128	124	95301	90
73146	157	79100	159	83515	125	85844	121	86129	124	95502	173
73156	157	79107	159	83516	125	85850	121	86130	124	95563	90
73180	150	79109	159	83550	127	85852	121	86131	124	95566	90
73182	150	79120	159	83630	127	85854	121	86132	124	95567	90
73195	163	79251	164	83640	127	85860	121	86133	124	95660	90
73217	165	79252	164	83715	125	85862	121	86134	124	95665	90
73218	165	79253	164	83716	125	85900	121	86135	124	95925	168
73233	159	79255	164	83717	125	85901	121	86136	124	96702	177
74002	163	79256	164	83718	125	85908	121	86137	124	96705	85
74004	163	79800	69	83740	127	85912	121	86138	124	99307	74
74015	164	79801	69	83750	127	85914	121	86139	124	99346	78
74020	163	79802	69	83910	127	85920	121	86140	124	99383	166
74048	163	79803	69	83930	127	85922	121	86141	120	99551	74
74053	163	79804	69	83940	127	85930	121	86142	120	99553	74
74078	164	79805	69	83950	127	85932	121	86143	120	99554	92
75000	160	79810	69	83999	128	85938	121	86148	130	99593	157
75060	160	79811	69	84640	127	85940	121	86150	118	99594	160
75068	159	79812	69	84710	127	85946	121	86151	118	99694	90
75085	160	79815	69	84730	127	85948	121	86152	118	99714	90
75096	161	79813	69	84740	127	85978	121	86154	118	99786	90
75097	161	79814	69	84750	127	85981	117, 122	86155	118	99788	90
75098	161	83000	125	84926	124	85995	121	86156	118	99791	90
75102	161	83002	127	84941	124	85996	121	86159	130	99801	173
75103	161	83003	127	84925	124	85997	121	86160	130	99805	173
75104	161	83004	127	85014	125	86097	116, 123	86165	126	99806	173
75105	161	83005	127	85156	127	86098	116, 123	86167	120	99823	85



# THE WEILER PROMISE

At Weiler, we passionately embrace change to improve our products and our processes to move the company and our customers forward. By bringing new ideas and creative problem solving together in an open, collaborative environment, we will improve our customers' productivity and create profitable growth.



## WEILER ABRASIVES GROUP

**Weiler  
Abrasives Group  
One Weiler Drive  
Cresco, PA 18326 USA**

Weiler de México  
Querétaro, México

Weiler do Brasil  
São Paulo, Brazil

SwatyComet, ToroFlex  
Bindlach, Germany

SwatyComet, Slovenia  
• Maribor (HQ)  
• Zreče  
• Loče  
• Oplotnica

Weiler Suzhou  
Suzhou, China